

P-01D

ISSUE DATE:

'11.10

NAME:

PHONE NUMBER:

MAIL ADDRESS:

INSTRUCTION MANUAL

Preface

Thank you for selecting the “P-01D”.

For proper use, read this manual before and when you use the P-01D.

Notes on Using this Mobile Phone

- This mobile phone is compatible with W-CDMA, GSM/GPRS and wireless LAN systems.
- Because this mobile phone uses radio waves, you cannot use it in places where the radio waves do not reach such as inside tunnels, basements and buildings, where the radio waves are weak even outdoors, or out of FOMA service area. You might not be able to operate this mobile phone even when you are in a place with a fine view such as on upper floors of a high-rise building or apartment. Note that you may experience interruption of calls even when the four-bar antenna mark is displayed indicating a strong radio wave and you are not moving.
- Since this mobile phone uses radio waves as the medium of telecommunication, calls may be tapped by a third party. However, the W-CDMA and GSM/GPRS systems automatically support tapping prevention, so your conversation will be incomprehensible to the third party, because it is recognized as mere noise.
- The mobile phones change your voice into digital signals and send them to the other party. In places where the radio waves are weak, the digital signals may not be converted correctly, and in such a case, the voice may sound different from the actual one.
- This mobile phone supports FOMA Plus-Area and FOMA High-Speed Area.
- You are advised that you make separate notes of information stored in this mobile phone and keep them in a safe place. Note that we cannot be held responsible for the unlikely event of loss of the stored content due to a malfunction, repair, change of your model, or other mishandling of this mobile phone.
- You are advised to save your important data on the microSD card.
- As with PC applications, some applications you have installed in this mobile phone may pose problems: unstable operations of your mobile phone, unauthorized distribution and use of your location and personal information stored in the mobile phone. Therefore, you need to thoroughly check the source and behaviors of intended applications before use.
- This manual assumes use of a DOCOMO UIM.

SIM Unlock

This mobile phone supports SIM unlocking. You can use another operator’s SIM card once you unlock the SIM.

- Contact a docomo Shop for SIM unlocking.
- You will be charged a SIM unlocking fee separately.
- When you use another operator’s SIM card, available services and functions are limited. Note that we provide no warranty of operations with other operator’s SIM cards.
- For details of SIM unlocking, refer to DOCOMO website.

Basic Package/Samples

■ Basic Package

- P-01D
(with warranty and Back Cover P53)

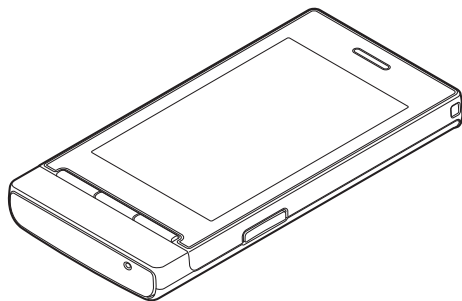

- Battery Pack P25

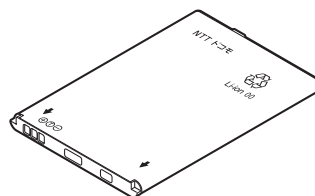

- AC Adapter Cable P01 (with warranty)
<AC adapter>

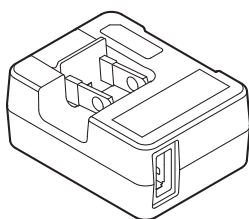

<microUSB cable>

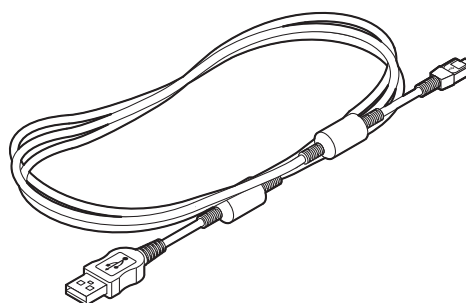

- Quick Start Guide (in Japanese)



■ Sample

- microSD card (2 GB) (with manual)



*Installed in the mobile phone at the time of purchase.

- For other optional items,  P.234

Descriptions of Operating Procedures

The operating procedures of the P-01D are described in the following manuals.

■ “Quick Start Guide” (in Japanese only) (supplied with this mobile phone)

Describes operating procedures of basic functions.

■ [Instruction Manual] (in Japanese only) (installed in your mobile phone)

Describes detailed information of functions and operating procedures.

Home screen ►  ► [Instruction Manual]

- Before using Instruction Manual for the first time, install the application from Android Market.

■ “Instruction Manual” (PDF)

Describes detailed information of functions and operating procedures.

Download from DOCOMO website:



<http://www.nttdocomo.co.jp/support/trouble/manual/download/index.html>

- * Note that the URL and published contents may be modified without notice.

Information

- It is prohibited to copy all or part of this manual without permission.
- The information contained in this manual may be changed without notice.
- Operating procedures when [docomo Palette UI] is set as the home application are explained in this manual. If you change the home application, some operating steps may differ from those described in this manual.
- Screenshots and illustrations shown in this manual are for reference. The actual ones may differ.
- Keys are simplified for explaining operating procedures in this manual.

Handling Precautions for this Mobile Phone

- This mobile phone is not compatible with i-mode site (program) and i-appli.
- This mobile phone is designed to perform communication automatically for some features such as data synchronization, check for the latest software version and maintaining a connection with the server. Communication of a massive amount of data such as application download and video watching will cost expensive packet communication fee, so we strongly recommend subscription to the flat-rate packet service.
- Public mode (drive mode) is not available for this mobile phone.
- Operation sounds such as shutter sound of the camera, etc. are emitted from this mobile phone even in Silent mode in which phone ringtone, touch tones and notification ringtone are muted.
- To confirm your phone number (My Details),  P.104
- To confirm the software version of your mobile phone,  P.143
- New features may be added to this mobile phone and operation method is subject to change due to future operating system (OS) upgrading. For the latest information on additional features and change of operation method, see DOCOMO website.
- OS upgrading may disable applications used in the old OS version or pose unwanted failure.
- For services provided by Google, Inc., read Google Terms of Service. For other web services, read the respective terms of service.
- In the event of loss of your mobile phone, be sure to change passwords for various service accounts from PC in order to prevent others from accessing your accounts for Google services such as Google Talk, Gmail and Android Market, Facebook, Twitter, and/or mixi.
- Providers other than sp-mode, mopera U and business mopera Internet are not supported.

- Although you can use this mobile phone without installing a microSD card, there are files that can only be stored on microSD card, such as images shot by Camera. Therefore, installing a microSD card is recommended when using this mobile phone.
- sp-mode subscription is required for using tethering.
- When using tethering, packet communication fee varies depending on the price plan. Using a flat-rate packet service is strongly recommended.
If you subscribe to a flat-rate packet service, packet communication fee is charged based on “communications made by connecting to a PC or other external device”. When tethering is enabled, all packet communications are regarded as “communications made by connecting to a PC or other external device”, even when the external devices are not connected.
Be sure to disable tethering when communication on the external device is finished.
- When tethering is enabled, sp-mode functions are not available except Internet access and mail service.
- When an external device is connecting to the Internet by tethering, applications (browser, games, etc.) may not work correctly on the device in some situations.
- No security measure such as password setting is applied between a smartphone/tablet and external device in the default setting of tethering. Setting a password is recommended.
- For details including usage fees, visit <http://www.nttdocomo.co.jp/english/>.

Contents

Basic Package/Samples.	1
Descriptions of Operating Procedures.	2
Handling Precautions for this Mobile Phone.	3
Precautions (ALWAYS FOLLOW THESE DIRECTIONS).	9
Handling Precautions.	22

Preliminary Check 32	Part Names and Functions.	32
	UIM.	35
	microSD Card.	37
	Battery Pack.	39
	Charging.	41
	Power On/Off.	44
	Basic Operations (How to Use Touch Panel).	46
	Screen Display/Icons.	49
Character Entry.	53	
docomo Palette UI 67	Home Screen.	67
	Application Screen.	71
	Home Application Settings.	79
Initial Setting 80	Initial Setting.	80
	Changing Screen Display to English	82
	Google Account.	83
	Setting Access Point.	84
	Email Setting.	87
	Wi-Fi.	89
	Online Service Accounts.	92
Phone/Network Services 93	Phone.	93
	Call Log.	99
	Phonebook.	100
	PhoneBookCopy.	105
	Available Network Services.	107

Various Settings 115	Setting Menu.	115
	Wireless & Networks.	116
	Call Settings.	120
	Sound.	122
	Display.	124
	Location & Security.	125
	Applications.	134
	Accounts & Sync.	135
	Privacy.	137
	Storage.	138
	Language & Keyboard.	139
	Voice Input & Output.	140
	Accessibility.	141
	Date & Time.	142
About Phone.	143	
Mail/Internet 144	sp-mode Mail.	144
	Message (SMS).	145
	Email.	148
	Gmail.	151
	Early Warning "Area Mail".	154
	Google Talk.	156
	Web Browser.	159
File Management 164	Infrared Communication.	164
	Bluetooth Communication.	167
	VPN (Virtual Private Network) Connection	171
	External Device Connection.	173



Applications 175	Camera.	175
	Gallery.	181
	Music Player.	183
	Android Market.	186
	Using docomo market.	188
	Future Plus.	189
	Google Maps.	197
	1Seg.	199
	ToruCa.	207
	YouTube.	208
	News & Weather.	209
	Clock.	211
	Calendar.	213
	Calculator.	216
	ECONAVI.	217
	Barcode Reader.	218
Catalyst Reader.	220	
SD backup.	222	
Overseas Use 224	Overview of International Roaming (WORLD WING).	224
	Available Services.	225
	Confirmation before Use.	226
	Settings for Overseas Use.	229
	Making/Receiving Calls in the Country You Stay.	231
	Confirmation after Returning Home	233

**Appendix
234**





Optional Items and Associated Equipment	234
.....	234
Troubleshooting (FAQ).	235
Warranty and After-Sales Service. . .	244
Software Update.	248
Main Specifications.	262
Specific Absorption Rate (SAR) of the Phone.	266
European RF Exposure Information	
.....	268
Declaration of Conformity.	269
FCC Notice.	270
FCC RF Exposure Information.	271
Important Safety Information.	273
Export Administration Regulations	
.....	275
Intellectual Property Right.	276
Index.	280



Precautions (ALWAYS FOLLOW THESE DIRECTIONS)

- Before using the mobile phone, read these safety precautions carefully so that you can use it correctly. After reading the precautions, keep them in a safe place.
- Be sure to observe these safety precautions to prevent you or those around you from inflicting injury and to avoid unnecessary damage to the property.
- The symbols below indicate the levels of danger or damage that can be caused if the particular precautions are not observed and equipments are not used properly.

	Danger	This symbol indicates that incorrect handling poses an imminent risk of causing death or serious injury.
	Warning	This symbol indicates that incorrect handling poses a potential risk of causing death or serious injury.
	Caution	This symbol indicates that incorrect handling poses a risk of causing an injury or damage to property.

- The following symbols show specific directions:

	Denotes actions prohibited to do. Don't
	Denotes not to disassemble the units. Do not disassemble
	Denotes not to touch with wet hands. Not wet hands
	Denotes not to use where the equipment may get wet, and avoid get it wet. Avoid Water

 Do	Denotes mandatory instructions (matters that must be complied with).
 Pull the power plug out	Denotes to pull the power plug out of an outlet.

■ **“Precautions” are divided into the following six sections:**

General Precautions for this Mobile Phone, Battery Packs, AC Adapter Cable, and UIM. P.10
 Precautions for this Mobile Phone. P.12
 Precautions for Battery Packs. P.15
 Precautions for AC Adapter Cable. P.17
 Precautions for UIM. P.19
 Notes on Using near Electronic Medical Equipment. P.19

General Precautions for this Mobile Phone, Battery Packs, AC Adapter Cable, and UIM

 **Danger**

 **Do not use, store, or leave the mobile phone or its accessories in places with a high temperature (such as near fire, near heating appliances, inside a kotatsu or near other furniture with heating elements, in places exposed to direct sunlight, or in cars heated by the sun).**
 Fire, burns, or injury may result.

 **Do not place the mobile phone or its accessories inside cooking appliances such as microwave ovens or high pressure containers.**
 Fire, burns, injury or electric shock may result.

 **Do not attempt to disassemble or remodel the mobile phone or its accessories.**
 Fire, burns, injury or electric shock may result.

 **Do not allow the mobile phone or its accessories to get wet either from water, drinking water or pet urine, etc.**
 Fire, burns, injury or electric shock may result.



Do

With your mobile phone, use the battery packs and AC adapter cables specified by NTT DOCOMO, INC.

Fire, burns, injury or electric shock may result.



Warning



Don't

Do not throw the mobile phone or accessories, or subject them to severe force or shocks.

Fire, burns, injury or electric shock may result.



Don't

Do not allow electrically conductive foreign objects (such as metal pieces or pencil leads) to come into contact with connector terminal or earphone/microphone terminal. Do not allow such objects to enter into the mobile phone.

Fire, burns, injury or electric shock may result.



Don't

Do not cover or wrap the mobile phone or its accessories with a cushion, etc. while it is being used or recharged.

Fire or burns may result.



Do

Before entering a gas station or other places where flammable gases are generated, be absolutely sure to turn off this mobile phone and stop charging if it is being charged.

Otherwise, the flammable gases may ignite.



Do

If odor, overheat, discoloration, or deformation is detected during use, battery charge, or storage, immediately follow the instructions below:

- Pull the power plug out of the outlet.
- Turn off the power of this mobile phone.
- Remove the battery pack from this mobile phone.

Fire, burns, injury or electric shock may result.



Caution



Don't

Do not place the mobile phone or accessories on unstable locations such as wobbly tables or slanted locations.

They may fall off and cause injury.



Don't

Do not store in humid or dusty places, or in high temperature environments.

Fire, burns or electric shock may result.



Do

If the mobile phone and its accessories are used by a child, a guardian should explain how to operate them correctly. During use, a guardian should also check that they are being used as instructed.

Otherwise, injury may result.



Do

Keep out of the reach of small children.

Accidental swallowing or injury may result.



Do

Take special care when you use this mobile phone for a long time with the AC adapter cable connected.

If you watch 1Seg programs and so on for a prolonged period of time while charging, the temperature of this mobile phone, battery pack or AC adapter cable may rise. If you keep direct contact with high-temperature parts, redness, itching, a rash or low-temperature skin burns may result depending on the state of your physical condition or constitution.

Precautions for this Mobile Phone



Warning



Don't

Do not directly point the infrared data port at someone's eyes during transmission.

Doing so may harm the person's eyes.



Don't

While using infrared communication, do not point the mobile phone's infrared data port at a home electrical appliance which is equipped with an infrared device.

The infrared device may malfunction, and possibly cause an accident.



Don't

Do not light the light close to eyes. Especially when shooting small children, be sure to stay at least 1 m away from them.

Doing so can damage eyesight. Also, accidents such as injury might occur if someone is startled or dazzled by the light.



Don't

Do not allow liquids such as water, or foreign materials such as metal pieces or flammable materials to get into the UIM or microSD card slot of this mobile phone.

Fire, burns, injury or electric shock may result.



Do not turn on the light toward car drivers.

It disturbs driving, and accidents may result.

Don't



Turn off this mobile phone in places where use is prohibited such as in airplanes and hospitals.

Do Otherwise, the electronic devices and electronic medical equipment in those places may be adversely affected. If the Auto power ON function is set, deactivate the setting, then turn off the power.

For use inside medical facilities, make sure that you comply with their regulations.

Engaging in any prohibited acts such as using the mobile phone in an airplane is punishable by law.

However, if use of the mobile phones in an airplane is permitted provided that radio wave transmission is turned off, you may do so in accordance with instructions of each airline.



When talking in Hands-free mode or when a ring tone is sounding, be absolutely sure to keep this mobile phone away from your ear.

Do Further, when you play games or play back music etc. with the earphone/microphone etc. connected, adjust the sound volume to moderate volume.

The excessive sound volume impairs your hearing.

Further, accidents may result due to the hardness of hearing of surrounding sound.



For those with weak heart conditions, the vibrator and ring volume must be adjusted carefully.

Do Otherwise, the functions may adversely affect your heart.



If you are using an electronic medical device or other type of device, check with its manufacturer or vendor regarding the influence of radio waves upon the device.

Do The mobile phone may adversely affect the device.



Turn off this mobile phone when near electronic devices using high-precision control or weak signals.

Do

The mobile phone may cause the electronic devices to malfunction and have other adverse effects.

* Electronic devices that may be affected:

Hearing aids, implanted cardiac pacemakers, implanted defibrillators, other electronic medical equipment, fire alarms, automatic doors and other automatically controlled devices. If you use an implanted cardiac pacemaker, implanted defibrillator or any other electronic medical equipment, consult the manufacturer or retailer of the device for advice regarding possible effects from the radio waves.



If the display part or camera lens is broken, be careful about broken glasses or the exposed interior of this mobile phone.

Do

A film is coated on the surface of the display area and the plastic panel is used for the surface of the camera lens, making it hard for the glass to break into pieces. However, if you touch the damaged or exposed parts by mistake, you may injure yourself.



Caution



Do not swing around this mobile phone by its strap, antenna or other parts.

Don't You may hit yourself or others, possibly causing injury or other accidents.



Do not use this mobile phone if it has been damaged.

Fire, burns, injury or electric shock may result.

Don't



When using the motion sensor, ensure that you check around you for safety, securely take hold of your mobile phone, and do not swing more than necessitated.

Don't

Otherwise, injury or other accidents may result.



Don't

The surface of the display is coated by a film that prevents the surface from damage so that your safety is ensured when you accidentally drop or give shock to your mobile phone (for preventing the reinforced glass from scattering). Do not forcibly peel off or give damage to the film.

If the display is damaged while you operate the mobile phone with the film peeled off, you might suffer an injury.



Don't

If you accidentally damage the display part and the substance inside leaks out, keep your face, hands and skin away from it.

Otherwise, you may impair your eyesight or damage your skin.

If this substance should get into your eyes or mouth, immediately rinse them with clean water, and then seek medical attention.

If it should adhere to your skin or clothing, immediately wipe it off with alcohol or similar liquid, and then rinse the affected area with soap and water.



Do

Before using the mobile phone inside a car, check with its manufacturer or dealer whether the radio waves will have any adverse effects.

In some vehicle models, the radio waves may adversely affect the electronic devices inside the vehicle. Such cases are rare. However, if this happens, stop using the mobile phone immediately.



Do

Itching, rash or eczema may be caused depending on your physical conditions or predisposition. If an abnormality occurs, stop using the mobile phone immediately, and then seek medical attention.

For material of each part,  P.20 "List of materials used"



Do

View the display in a sufficiently light place keeping a certain distance from your eyes.

Otherwise, your eyesight may become impaired.

Precautions for Battery Packs

- Check the description on the label of the battery pack for the type of battery.

Description	Type
Li-ion 00	Lithium-ion battery



Danger



Don't

Do not let any metal object such as a wire come in contact with the battery terminals. Also do not carry or store the battery pack together with any metal objects like a necklace.

Otherwise, the battery pack may ignite, burst or overheat and its electrolyte may leak.



Don't

When installing the battery pack in this mobile phone, check that it is facing the right way, and if the battery pack cannot be installed easily, do not force it into place.

Otherwise, the battery pack may ignite, burst or overheat and its electrolyte may leak.



Don't

Do not throw the battery pack into fire.

Otherwise, the battery pack may ignite, burst or overheat and its electrolyte may leak.



Don't

Do not pierce it with nails, hit it with a hammer, or step on it.

Otherwise, the battery pack may ignite, burst or overheat and its electrolyte may leak.



Do

If the battery fluid or other material gets into your eyes, do not rub them. Flush your eyes with clean water and seek medical attention immediately.

Otherwise, the loss of eyesight may result.



Warning



Don't

Never use the mobile phone if it has damages such as deformities or scratches as a result of dropping it.

Otherwise, the battery pack may ignite, burst or overheat and its electrolyte may leak.



Do

Immediately stop using the mobile phone and keep it away from fire if the battery pack leaks or emits an odor.

The leaked battery fluid may ignite, causing fire or burst.



Do

Be careful that your pets do not bite into the battery pack.

Otherwise, the battery pack may ignite, burst or overheat and its electrolyte may leak.



Caution



Do not dispose of the battery pack with other waste.

Don't The battery pack may catch fire or damage the environment. After insulating the battery terminals with tape, take the unneeded battery pack to a handling counter such as a docomo Shop or dispose of it in accordance with local waste disposal regulations.



Do not use or attempt to charge a wet battery pack.

Don't Otherwise, the battery pack may ignite, burst or overheat and its electrolyte may leak.



If the electrolyte fluid or other material inside the battery pack has leaked out, do not allow it to come into contact with the skin on your face, hands or any other part of your body.

Do

Contact may result in loss of sight or skin problems. If you get the fluid or other material in your eyes or mouth, or on skin or clothing, immediately wash the affected areas with clean water.

If you get it in your eyes or mouth, immediately seek medical attention after rinsing.

Precautions for AC Adapter Cable



Danger



Do not connect microUSB cables other than the supplied one.

Don't Fire, burns or electric shock may result.



Warning



Do not use the microUSB cable if it has been damaged.

Don't Fire, burns or electric shock may result.



Do not use the AC adapter cable in humid places such as a bathroom.

Don't Fire, burns or electric shock may result.



If a thunderstorm is nearby, do not touch the AC adapter cable.

Don't

Otherwise, you may receive an electric shock.



Never short-circuit the AC adapter cable plug or terminal when the AC adapter is plugged into the power outlet. Also, never touch the plug or terminal with fingers or other bare skin.

Don't

Fire, burns or electric shock may result.



Do not place heavy objects on the microUSB cable.

Don't

Fire, burns or electric shock may result.



When plugging the AC adapter into the power outlet, or when unplugging it from the outlet, do not allow metal straps or other metal objects to come in contact with it.

Don't

Fire, burns or electric shock may result.



Do not touch the AC adapter cable or power outlet with wet hands.

Not wet hands

Fire, burns or electric shock may result.



Use the adapter at the specified V AC.

Do

Supplying the wrong voltage to the AC adapter may result in a fire, burns or electric shocks.

100 V - 240 V AC

(Connect only to household AC outlet.)



Keep the power plugs dust-free.

Do

Fire, burns or electric shock may result.



When plugging the AC adapter into the power outlet, plug it in securely.

Do

Fire, burns or electric shock may result.



When unplugging the power plug from the power outlet, take hold of the AC adapter to unplug it.

Do

Fire, burns or electric shock may result.



Pull the power plug out

When you do not intend to use the adapter for a long period of time, disconnect the power plug from the power outlet.

Fire, burns or electric shock may result.



Pull the
power plug
out

If liquids such as water get in the adapter, unplug the power plug immediately from the outlet.

Fire, burns or electric shock may result.



Pull the
power plug
out

Before cleaning, pull the power plug out of the outlet.

Fire, burns or electric shock may result.

Precautions for UIM



Caution



Be careful not to touch the cut surface of the UIM when removing it.

Do Otherwise, injury may result.

Notes on Using near Electronic Medical Equipment

- The description below meets “Guidelines on the Use of Radio-communication Equipment such as Cellular Telephones – Safeguards for Electronic Medical Equipment” by the Electromagnetic Compatibility Conference Japan.



Warning



Comply with the following in hospitals or health care facilities:

- Do
- Do not carry this mobile phone into operating rooms, intensive care units (ICU) or coronary care units (CCU).
 - Turn off this mobile phone in hospital wards.
 - If there is any electronic medical equipment near you, turn off this mobile phone even when in a location such as a lobby.
 - Comply with any regulations of hospital and health care facilities instructing you not to use or carry in a mobile phone.
 - If the Auto power ON function is set, deactivate the setting, then turn off the power.



Do

Turn off this mobile phone in trains during the rush hour or other crowded areas as there may be someone near you with an implanted cardiac pacemaker or implanted defibrillator.

The mobile phone's radio waves may adversely affect the operation of implanted cardiac pacemakers and implanted defibrillators.



Do

If you use electronic medical equipment such as implanted cardiac pacemaker or implanted defibrillator, carry and use this mobile phone 22 cm or more away from the implanted cardiac pacemaker or implanted defibrillator.

The mobile phone's radio waves may adversely affect the operation of electronic medical equipment.



Do

Patients using electronic medical equipment other than implanted cardiac pacemakers or implanted defibrillators (outside medical establishments for treatment at home, etc.) should check the influence of radio waves upon the equipment by consulting its manufacturer.

The mobile phone's radio waves may adversely affect the operation of electronic medical equipment.

■ List of materials used

Where it is used		Material/Finishing
Earphone/microphone terminal (resin part)		PA
Outer casing	Display surface, Battery surface	PC/UV coating
	Stopper (Battery surface)	POM
	Back cover	PC+ABS/UV coating
Connector terminal		Stainless steel/nickel plating
Connector terminal cover	Surface	PC+ABS/UV coating
	Connector area	PU
Camera lens area		PMMA
Speaker area		Polyester
Display panel		Glass, PET/surface hard coating

Where it is used		Material/Finishing
Battery compartment surface		Glass epoxy substrate
Battery terminal	Resin part	LCP
	Terminal area	Beryllium copper/nickel plating, gold plating
Battery pack	Resin part	PC+ABS
	Label	PET
	Terminal area	Copper/nickel plating, gold plating
UIM/microSD card slot	Resin part	LCP
	Terminal area	Beryllium copper/nickel plating, gold plating
	Top end area	Stainless steel
Screws (inside of the back cover)		Carbon steel/nickel plating
Keys		PC/UV coating
Label	Battery surface	PP
Label (Battery compartment surface)		PET
Label (Battery surface)	Speaker side	PC
	Camera side	Stainless steel
1Seg antenna	Tip resin part	ABS/UV coating
	Metal part (Sleeve area/Pipe area/Wire area), Hinge part at bottom part (Wire connection area/Pin/Lift up area)	Stainless steel
	Holder area	Zinc alloy/nickel plating

Handling Precautions

General Notes

■ Do not wet the equipment.

This mobile phone, battery pack, AC adapter cable, and UIM are not waterproofed. Do not use them in environments, which are high in humidity such as in bathrooms, and do not allow them to get wet from rain. Furthermore, if carrying them against your body, they become moist due to perspiration and the internal parts may become corroded, causing malfunction. If the parts are found to have been damaged due to exposure to the liquids, any repairs will not be covered by warranty, or repairs may not be possible. This may be repaired at a cost if repairs are possible.

■ Use a dry soft cloth such as the one for cleaning glasses to clean the equipment.

- The display may be scratched if it is rubbed hard with a dry cloth.
- Stains may result from droplets of water or dirt if they are left on the display.
- Do not use alcohol, thinner, benzene, detergent or other solvents for cleaning, otherwise the printing may be removed or discoloration may result.

■ Occasionally clean the terminals of the equipment using a dry cotton swab, etc.

The soiled terminals deteriorate the connection and might cause power discontinuity or incomplete charging. Wipe the terminals with a cotton swab, etc.

Take care not to damage the terminals when cleaning them.

■ Do not place the mobile phone near an air conditioner outlets.

Condensation may form due to rapid changes in temperature, and this may corrode internal parts and cause malfunction.

- **Do not apply excessive force onto this mobile phone and battery pack.**

If you put the mobile phone in a bag along with many other articles or sit with the mobile phone in a clothes pocket, the display, internal circuitry and the battery pack could be damaged or malfunction.

Also, if an external device is left connected to the connector terminal or the earphone/microphone terminal, the connector could be damaged, or malfunction.

- **Do not rub or scratch the display part with metals.**

Doing so might cause damage to the part, resulting in failure or malfunction.

- **Carefully read each instruction manual attached to battery pack or AC adapter cable.**

Notes on Handling this Mobile Phone

- **Never forcibly press the surface of the touch panel, or operate it with something having a sharp point like a claw, ballpoint pen, or pin.**

Damage to the touch panel might result.

- **Avoid using in extremely high or low temperatures.**

The mobile phone should be used within a temperature range of 5°C to 35°C and a humidity range of 45 % to 85 %.

- **If the mobile phone is operated near a land-line phone, television set, radio or other devices in use, it may adversely affect the devices. Operate the mobile phone as far away from these devices as possible.**

- **It is recommended that you make separate notes of the information stored in this mobile phone and keep such notes in a safe place.**

We take no responsibility for any loss of the stored data items.

- **Do not drop this mobile phone or subject it to strong impacts.**

Malfunction or damage may result.

- **Do not insert an external device to the connector terminal or the earphone/microphone terminal at a slant when connecting, and do not pull it out when it is inserted.**

Malfunction or damage may result.

■ **This mobile phone becomes warm during use or charging but this is not an abnormality. Use the mobile phone as it is.**

■ **Do not leave the camera in places exposed to direct sunlight.**

Pixels may be discolored or burns may result.

■ **When using the mobile phone, ensure that you close the cover for the connector terminal.**

Dust or water might enter into the mobile phone, causing malfunction.

■ **Do not use the mobile phone with the back cover left removed.**

The battery pack might come out, or malfunction or damage may result.

■ **While you are using the microSD card, never take it off or turn off the power of this mobile phone.**

Data may be erased or malfunction may result.

■ **Do not place magnetic cards or similar objects near this mobile phone.**

Magnetic data on cash cards, credit cards, telephone cards and floppy disks, etc. may be deleted.

■ **Do not bring magnetic substances close to your mobile phone.**

Problems with operation may result if items with strong magnetic fields are brought close to the mobile phone.

Notes on Handling Battery Packs

■ **Battery pack is a consumable item.**

Though it depends on the usage state, you are advised to replace the battery pack if its usable time is extremely short even when you fully charge it. Make sure that you buy a specified battery pack.

■ **Charge the battery in a place with an appropriate ambient temperature of 5°C to 35°C.**

■ **The usable time of the battery pack differs depending on the usage environment and its remaining life.**

■ **Depending on how the battery pack is used, it might swell as its remaining life becomes short, but this is not a problem.**

■ **Note the following points when you store a battery pack:**

- Storage in a fully charged state (the state immediately after charging is completed)
- Storage with no battery power left (the state you cannot turn on the power of the main unit due to battery drain)

These may lower the battery pack's performance and shorten its operating life.

Before storing a battery pack, check its remaining battery level: it is recommendable, as a general rule, for its remaining battery level to be about 40 %.

Notes on Handling AC Adapter Cable

■ **Charge the battery in a place with an appropriate ambient temperature of 5°C to 35°C.**

■ **Charge the battery where:**

- There is very little humidity, vibration, and dust.
- There are no land-line phones, television sets or radios nearby.

■ **While you are charging, the AC adapter cable may become warm. This is not a malfunction, so you can keep on using.**

■ **When using the power outlet having the disengaging prevention mechanism, observe the instructions given in that instruction manual.**

■ **Do not give a strong shock. Also, do not deform the charging terminal.**

Malfunction may result.

Notes on Handling the UIM

- Do not apply more force than is necessary when installing or removing the UIM.
- The warranty does not cover damage caused by inserting the UIM into some other types of IC card reader/writer.
- Always keep the IC portion clean.
- Use a dry soft cloth such as the one for cleaning glasses to clean the UIM.
- It is recommended that you make separate notes of the information stored on the UIM and keep such notes in a safe place.

We take no responsibility for any loss of the stored data items.

- For the environmental protection, bring any unneeded UIMs to a handling counter such as a docomo Shop.
- Do not damage, carelessly touch, or shortcircuit the IC.
Data might be lost or malfunction may result.
- Do not drop the UIM or subject it to strong impacts.
Malfunction may result.
- Do not bend the UIM or place something heavy on it.
Malfunction may result.
- Into this mobile phone, do not insert the UIM with a label or sticker pasted.
Malfunction may result.

Notes on Using Bluetooth Function

- This mobile phone supports the security function that meets the Bluetooth Specification, to secure Bluetooth communication. However, the security may not be sufficient depending on the settings. Take care of the security for communication when using the Bluetooth function.
- Note that even if any leak of data or information occurs while making connection using the Bluetooth function, we take no responsibility.
- With this mobile phone, you can use the following: Headset, Hands-Free, Audio, and Object Push. With Audio, you might be able to use Audio Video Remote Control. (Only with the compatible Bluetooth devices)
- Radio frequencies
The radio frequencies for the Bluetooth function of this mobile phone are as follows:

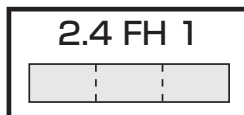

- 2.4 : Indicates radio facilities that use 2400 MHz frequencies.
- FH : Indicates modulation is the FH-SS system.
- 1 : Indicates that an estimated interference distance is 10 meters or less.
-  : Indicates that all radio frequencies 2400 MHz through 2483.5 MHz are used, and that the frequencies for mobile object identifiers shall not be avoided.

To use on airplane, confirm with airline company in advance. Use of Bluetooth may be prohibited in some countries. Please confirm laws and regulations applicable in the country/region before use.

■ Cautions on Using Bluetooth Devices

Bluetooth operates at radio frequencies assigned to the in-house radio stations for mobile object identifiers that have to be licensed and are used in production lines of a factory, specific unlicensed low power radio stations, and amateur radio stations (hereafter, referred to “another radio station”) in addition to scientific, medical, industrial devices, or home electric appliances such as microwave ovens.

1. Before using this mobile phone, make sure that “another radio station” is not operating nearby.
2. If radio wave interference between this mobile phone and “another radio station” occurs, move immediately to another place or turn off power to avoid interference.
3. For further details, contact “General Inquiries” on the back page of this manual.

Notes on Handling Wireless LAN (WLAN)

■ **Wireless LAN (WLAN)** has an advantage of any-place LAN connectivity within the radio wave range as it establishes communication via radio wave. At the same time, however, you have a risk that malicious third party may break into the network and steal communication contents without security measures. It is recommended to take security measures at your discretion and responsibility.

■ **Wireless LAN**

Do not use Wireless LAN in a place where magnetized by electric product, AV, OA equipment, etc. or where electromagnetic wave is generated.

- If magnetism or electrostatic noise affects your mobile phone, noise may be increased or communication may not be available (especially when using microwave oven, it may affect your mobile phone).
- Using near TV or radio may cause poor reception or TV screen may be disturbed.
- When multiple wireless LAN access points exist near your mobile phone and they use the same channel, search may not be performed correctly.

■ Radio frequencies

The radio frequencies for WLAN devices are written on battery compartment of your mobile phone. Label description are as follows:

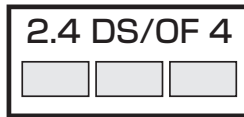

- 2.4 : Indicates radio facilities that use 2400 MHz frequencies.
- DS/OF : Indicates modulation is the DS-SS/OFDM system.
- 4 : Indicates that an estimated interference distance is 40 meters or less.
-  : Indicates that all radio frequencies 2400 MHz through 2483.5 MHz are used, and that the frequencies for mobile object identifiers shall be avoided.

Available channels vary depending on countries.

To use on airplane, confirm with airline company in advance.

Use of wireless LAN may be prohibited in some countries. Please confirm laws and regulations applicable in the country/region before use.

■ Cautions on Using 2.4 GHz Devices

The bandwidth of the WLAN devices is assigned to the in-plant radio stations for identification of mobile objects used in production lines of a factory (a license is required), specified low power radio stations (a license is not required), or amateur radio stations (a license is required), in addition to home electric appliances such as a microwave oven, industrial/scientific/medical devices.

1. Before using this device, confirm that in-plant radio stations for identification of mobile objects, specified low power radio stations or amateur radio stations are not in operation in your neighborhood.
2. If this device generates harmful radio wave interference against in-plant radio stations for identification of mobile objects, immediately change the radio frequency or stop using wireless LAN function, and contact "General Inquiries" on the back page of this manual, then consult about treatment for prevention of the interference (for example, installation of partitions etc.).
3. If this device generates harmful radio wave interference against in-plant radio stations for identification of mobile objects or amateur radio stations, or if any trouble occurs, contact "General Inquiries" on the back page of this manual.

Caution

■ Do not use the modified mobile phone. Using a modified mobile phone infringes the Radio Law.

The mobile phones are granted technical regulations conformity certification as the specified radio equipment under the Radio Law and bear a "technical conformity mark"  on the nameplate as evidence of conformity.

Unscrewing the mobile phone and modifying internal components void the technical regulations conformity certification.

Do not use the mobile phone in this state, which infringes the Radio Law.

■ **Take special care not to operate the mobile phone while driving.**

Holding a mobile phone in your hand while driving is subject to a fine or other penalties.

However, this does not apply in unavoidable circumstances when, for instance, rescuing someone who is sick or injured or when maintaining public order.





■ **Do not make any unauthorized or unsanctioned changes to the basic software.**

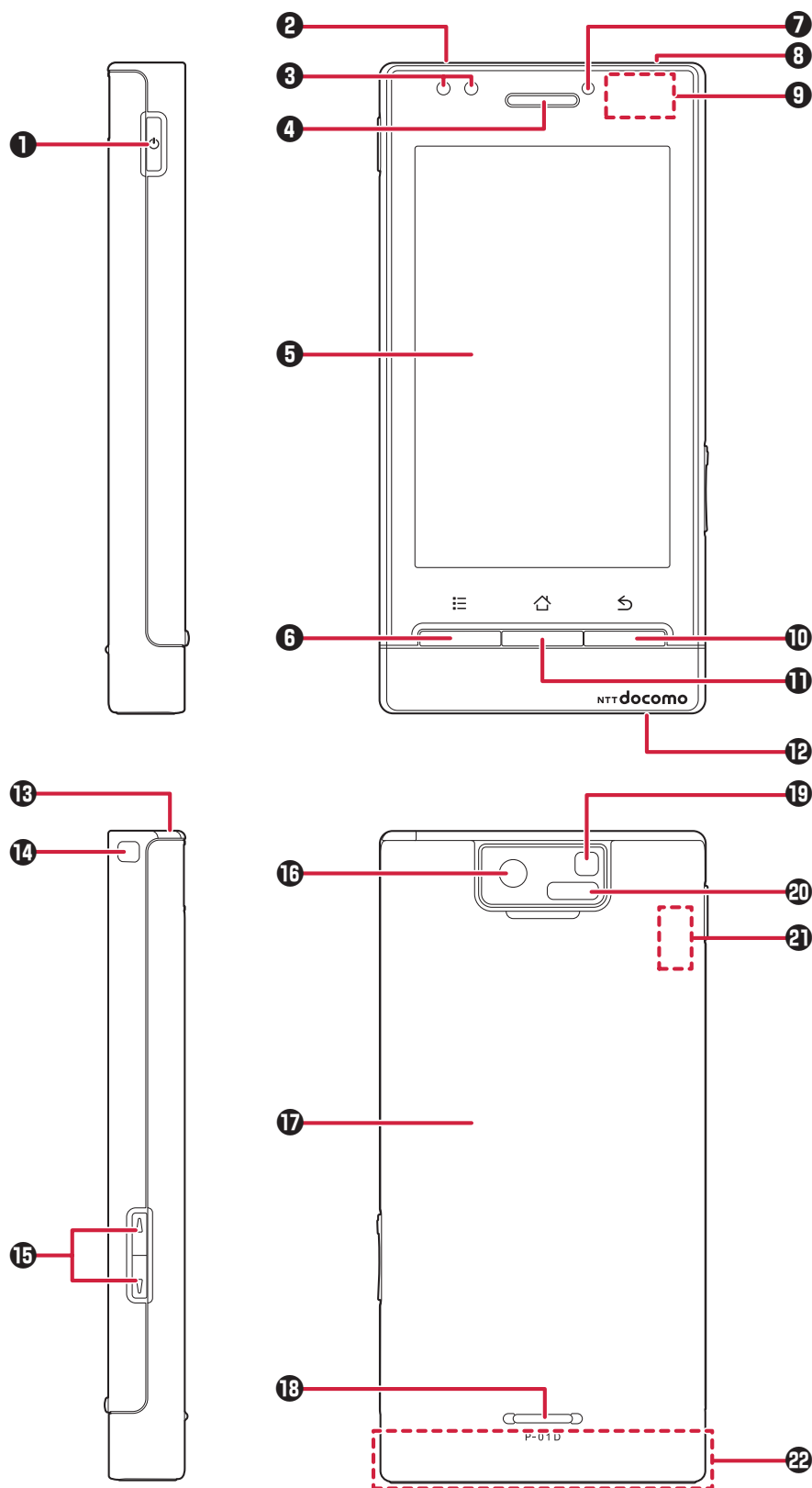

Such changes will be construed as remodeling and, as a result, requests to repair faults may be denied.

Preliminary Check

Part Names and Functions



	Name	Description
1	 Power key	Press and hold this key for at least two seconds to turn the power on (☞ P.44). To press and hold this key for at least one second when the power is on, set/cancel the Silent mode or Flight mode, or turn the power off. Set/cancel the Sleep mode (☞ P.44).
2	Earphone/ microphone terminal	-
3	Light sensor	Detects ambient brightness to automatically adjust the screen brightness. In order for the sensor to detect the brightness, do not cover it with your hand or attach a seal on it.
	Proximity sensor	A sensor that prevents false operation of the touch panel during call. Protective seat or seal attached on the proximity sensor may cause malfunction of the sensor.
4	Earpiece	You can hear voice of the other party from this part.
5	Display (Touch panel)	Slide your finger to scroll the screen, or tap an item to select it (☞ P.46).
6	 Menu key	Display the option menu available in the current screen.
7	Call/Charging indicator	Flashes when the mobile phone receives a call or message. Lights during charging.
8	Connector terminal	Connect the included microUSB cable for charging or a PC connection.
9	Wi-Fi/Bluetooth antenna	The antenna is embedded in the main unit. Do not cover this part with your hand, as it may impair antenna quality.
10	 Back key	Return to the previous screen.
11	 Home key	Return to the home screen (☞ P.67). Press and hold this key to display recently-used applications.

	Name	Description
12	Microphone	Send your voice from this part. Serves as a microphone when recording sound.
13	1Seg antenna	Extend this antenna when you watch 1Seg (☞ P.200).
14	Strap hole	-
15	 /  Volume keys	Adjust the volume of the other party's voice or sound from the speaker (☞ P.98, P.122).
16	Camera	Shoot still images and videos (☞ P.175).
17	Back cover	-
18	Speaker	From this part, you can hear ringtones, music and the other party's voice during hands-free call.
19	Photo light	Lights at the time of shooting with the camera.
20	Infrared data port	Used for infrared communication (☞ P.164).
21	GPS antenna	The antenna is embedded in the main unit. Do not cover this part with your hand, as it may impair antenna quality.
22	FOMA antenna	The antenna is embedded in the main unit. Do not cover this part with your hand, as it may impair antenna quality.

UIM

The UIM is an IC card that holds your information such as phone number. Unless the UIM is installed, you cannot use the mobile phone's communication features such as call, messaging and data communication.

- The UIM (blue) is not usable with this mobile phone. If you have a UIM (blue), bring it to a docomo Shop to replace.
- For details about the UIM, refer to the Instruction Manual of the UIM.

Installation/Removal of UIM

- Installation/removal of the UIM should be performed with the mobile phone turned off, the battery pack removed, and microSD card installed (☞ P.37, P.40).
- Be careful not to touch or damage the IC part when handling the UIM. Attempts to install/remove the UIM forcibly may damage the UIM.

Installing UIM

1 With the UIM's golden IC surface downward, push the UIM straight to the slot at the upper row to the end

- Insert the UIM with the corner cut ahead.

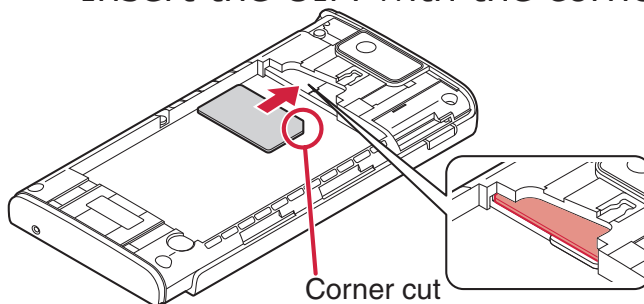

Removing UIM

- 1** While pushing the UIM with the tip of your finger, slide it slowly toward you, and remove it

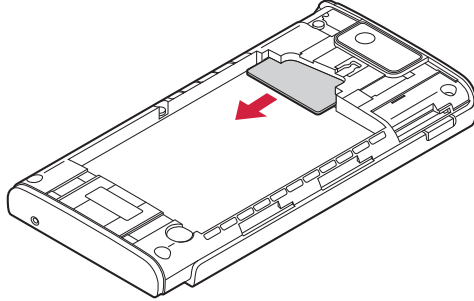

About Security Codes for UIM

Two security codes are provided for the UIM: PIN1 code and PIN2 code (☞ P.128).

microSD Card

- This mobile phone supports microSD cards of up to 2 Gbytes and microSDHC cards of up to 32 Gbytes (as of October 2011). For the latest information on supported microSD cards including manufacturers and storage capacities, refer to the following website. For microSD cards not listed on the website, please consult the manufacturer of the microSD card in question.

<http://panasonic.jp/mobile/> (in Japanese only)

Note that since the information in the website has been obtained by checking of some operations, not all operations are guaranteed.

Installation/Removal of microSD Card

- Installation/removal of a microSD card should be performed with the mobile phone turned off, and the battery pack and the UIM removed (☞ P.36, P.40).

Installing microSD Card

- 1** Hold the microSD card in such a way that its metal terminal surface is face down, and insert the card straight into the bottom microSD card slot in the direction shown in the illustration

- Insert the microSD card about halfway, and press down gently on area **1** so that the card is made level. With the card still pushed halfway in, insert the edge of the card (area **2**) straight into the slot as far as it will go.

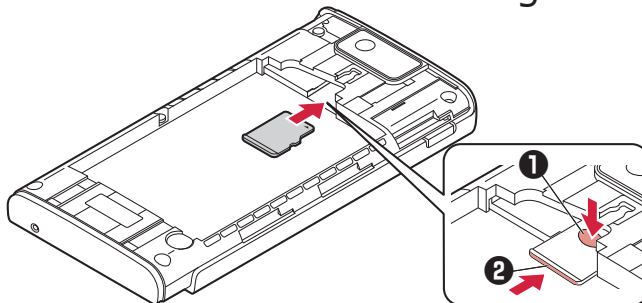

Removing microSD Card

- 1** Hook the tip of your finger into the groove of the microSD card, and pull the card straight out of the slot

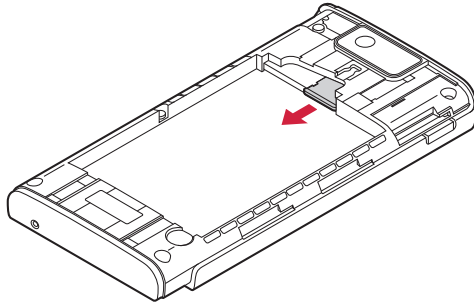

Battery Pack

Installation/Removal of Battery Pack

- Installation/removal of the battery pack should be performed with the mobile phone turned off.

Installing Battery Pack

- 1** To remove the back cover, press on the area of the cover around the speaker with both hands, and slide in the direction indicated by the arrow until the lock is released as per the illustration

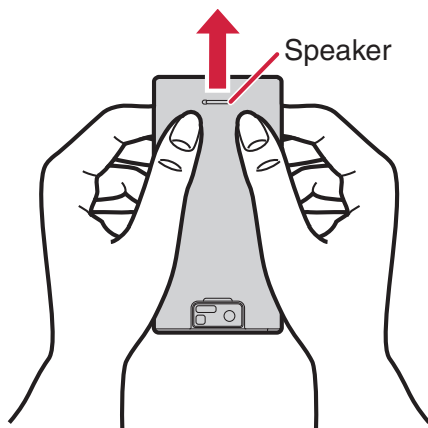

- 2** With the arrow marks facing up, fit the battery pack to the tab side of the mobile phone securely, and then push the battery pack in direction **2** while pressing it against direction **1**

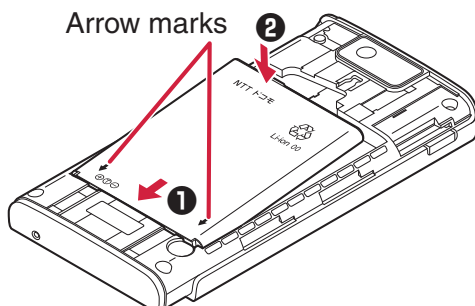

3 To attach the back cover, align the cover with the mobile phone and slide it in the direction of the arrow

- Confirm there is no gap between the back cover and the mobile phone.

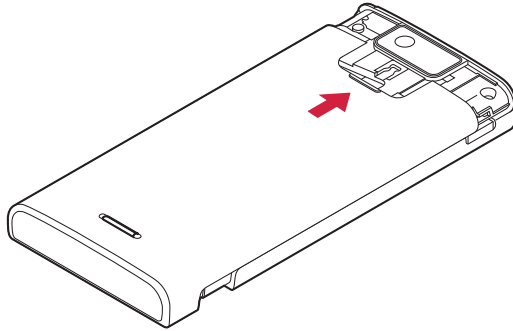

Removing Battery Pack

1 Remove the back cover (➔ step 1 in P.39 “Installing Battery Pack”)

2 Lift the battery pack in the direction of the arrow using its projection

- If you remove the battery pack when there is no UIM inserted, be careful not to touch the terminal in the UIM slot.

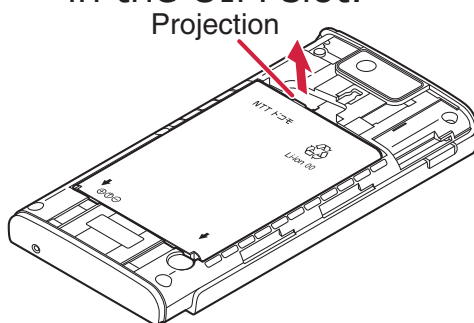

Charging

■ Precautions for charging

- The included AC adapter plug shape is designed for 100V AC (domestic specification). To charge the battery abroad, a corresponding plug adapter is required. Do not use an adapter transformer for overseas trip.
- If you charge the mobile phone while using it, it may take more time to fully charge the battery or charging may not be completed. Continuous use of functions consuming large current, such as data communication and call, may decrease battery level even during charging, leading to battery drain.
- If you start charging when the battery is empty, the mobile phone may not start up promptly after power-on operation. In this case, start charging with the mobile phone off and turn it on after a while.
- If you leave the mobile phone being charged for long time, the mobile phone consumes power from the battery pack after completion of charging, so the usable time may be shortened and alert of empty battery may be displayed soon. In such a case, start charging the battery again in correct manners. For recharging, disconnect the AC adapter cable from the mobile phone and then connect it again.

■ Battery pack operating life

- Battery pack is a consumable item. Usable time per charge gradually decreases with repeated charging.
- When its usable time per charge is decreased to about a half of that from the time of purchase, the battery pack is near the end of life. So you are recommended to replace with new one soon. Depending on how the battery pack is used, it might swell as its remaining life becomes short, but this is not a problem.
- Continuous 1Seg watching while charging may shorten the battery pack operating life.

To prevent damage to the environment, bring used battery packs to a docomo service counter, a docomo agent or a recycle center.



Li-ion 00



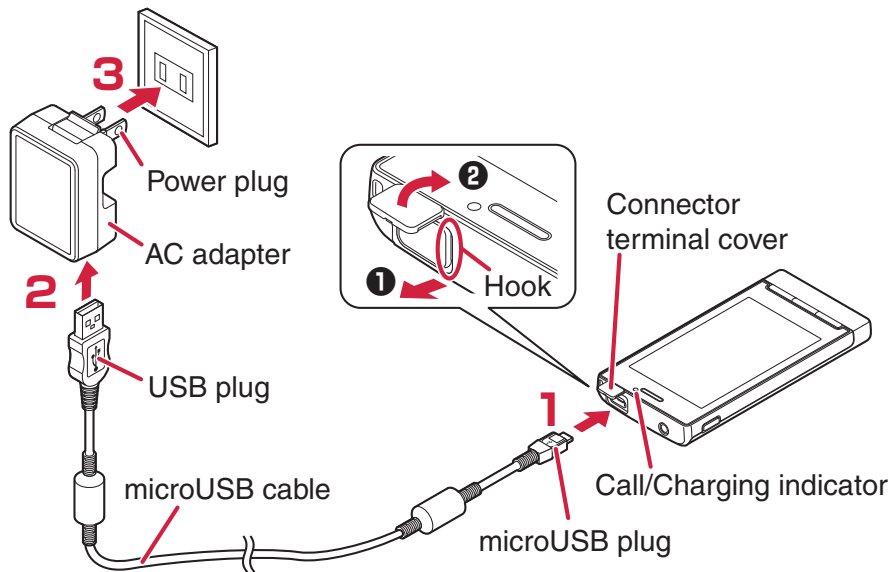



Charging by Using AC Adapter Cable



- 1** Insert the provided microUSB plug of microUSB cable horizontally into the connector terminal with USB mark (↔) facing up
 - Hook the tip of your finger into the groove of the external connector terminal cover, pull the cover out in direction ① and then lift the cover in direction ②.
- 2** Insert the USB plug of microUSB cable horizontally into the USB connector of AC adapter with USB mark faced with you
- 3** Unfold the power plug of AC adapter, and plug it into a household outlet of 100 V AC
- 4** When charging is completed, pull out the power plug of AC adapter from the outlet
- 5** Remove the microUSB cable from the AC adapter and the mobile phone

■ Charging and charging completed indications

● When the mobile phone is turned on

	Call/Charging indicator	Battery icon
Charging	Lights as follows according to the battery level. 89% or less: Red 90% or more: Green	Indications are switched from the current battery level up to level 6.  Level 6  Level 5  Level 4  Level 3  Level 2  Level 1
Charging completed	Lights in green	

● When the mobile phone is turned off

	Call/Charging indicator
Charging	Lights in red
Charging completed	Turns off

- The battery icon is not displayed when the mobile phone is turned off. The call/charging indicator may not light promptly when you start charging with the battery in empty state. However, charging has been started. If the call/charging indicator does not light after a while, remove the battery pack from the mobile phone and then reinstall it before charging again. If the symptom recurs, the AC adapter and battery pack may be failed. Contact a handling counter such as a docomo Shop.

■ When the battery has almost run out

When the battery starts running out, a message that prompts you to charge appears. When the battery becomes empty, a message that the power is turned off shortly appears and then it is turned off.

Charging by Using a PC

This mobile phone can be charged from a PC when you connect the mobile phone and a PC using the included microUSB cable.

- For how to connect the mobile phone to a PC,  P.173

Power On/Off

Turning Power On

1 Press and hold  for at least two seconds

The lock screen appears after a while.

Turning Power Off

1 Press and hold  until Phone options menu appears

2 [Power off] ► [OK]

- Wait for a while, as it may take some time before the power is turned off.

When Display Goes Off

If this mobile phone is not operated for a certain period of time, the display automatically goes off and the mobile phone enters the Sleep mode.



1  / 

The Sleep mode is canceled and the lock screen appears.

- To enter the Sleep mode manually, press  when the display is on.

Unlocking Lock Screen

1 Drag  to the right

- Drag / to left to set/cancel Silent mode.

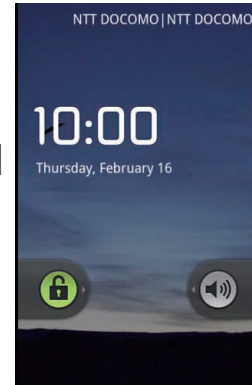

Lock screen

Basic Operations (How to Use Touch Panel)

Touch Panel Operations

The display of this mobile phone is a touch panel, which is operated by direct touch with fingers.

- Before use, peel off the protective sheet which is stuck on the touch panel at the time of purchase.
- The touch panel is designed to be touched lightly with a finger. Do not press it strongly with a finger or pointed objects such as fingernails, ballpoint pens, and pins.
- In the following cases, the touch panel may not work even if you touch it. Also, following operations may cause a malfunction.
 - Operation wearing gloves
 - Touching with a fingernail
 - Operation with foreign objects placed on the operation surface
 - Operation on the touch panel on which a protective sheet or a sticker is put

■ Tap

Tap an item or icon on the screen to select it.

■ Double-tap

Tap the screen twice quickly to zoom in the web page. Double-tap again to zoom out.

■ Touch and hold

Keep an item or icon on the screen touched with your finger for a while. Do this to display a pop-up menu, etc.

■ Flick

When there are multiple pages or more contents outside the screen, quickly move your finger right or left across the surface of the screen to show the previous/next screen.

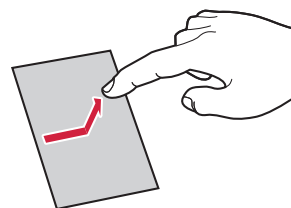

■ Drag

Move an item or icon on the screen while holding it with your finger.

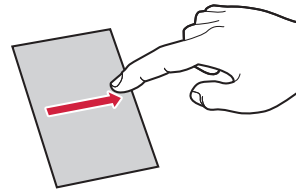

■ Scroll

Slide your finger up/down or right/left on the screen to show the hidden part.

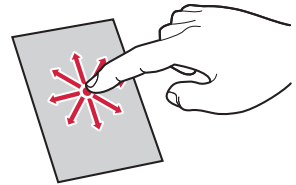

■ Pinch (spread apart/pinch together)

Placing two fingers on the screen, spread them apart to zoom in, or pinch them together to zoom out, when a web page or still image is displayed.

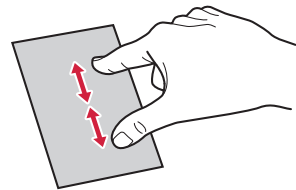

Information

- Some multi-touch operations such as operation with three or more touch points are not possible.

Switching Vertical/Horizontal Display Modes

The motion sensor, which detects orientation and motion of the mobile phone, allows you to switch display modes by holding the mobile phone in vertical or horizontal orientation.

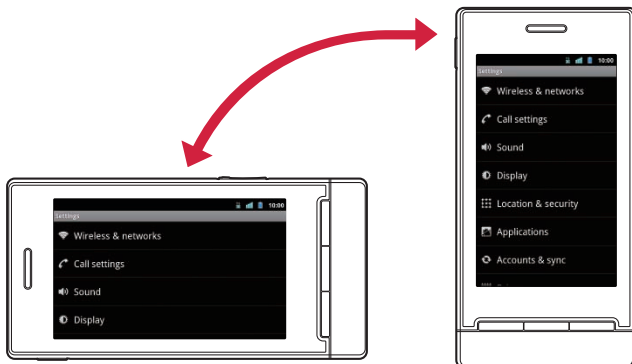

Information

- Operate the mobile phone in nearly upright state. If the mobile phone lies flat, the sensor cannot detect a change in orientation and motion properly, and the display modes may not be switched.
- Changing the mobile phone's orientation may not switch display modes depending on the screen displayed.

Screen Display/Icons



















Icon Definitions















Icons that indicate the mobile phone status are displayed in the status bar.

Notification icons are displayed on the left part while status icons are displayed on the right part of the status bar.











Status bar 















■ Main notification icons

Icon	Description	Refer to
	New Gmail	P.152
	New Email	P.149
	New sp-mode mail	P.144
	New message (SMS)	P.146
	Failure to send message (SMS)	P.145
	Voice Mail message	P.108
	New instant message	P.156
	Calendar event	P.214
	Music playing	P.183
	Wi-Fi open network available	P.89
	Incoming file via Bluetooth communication	P.170
	VPN connected/disconnected	P.171
	USB connected	P.173
	USB tethering in use	P.117
	Wi-Fi tethering in use	P.118
	Both USB tethering and Wi-Fi tethering in use	P.117 P.118
	Error message	-
	During call	P.93
	Missed call	P.99

Icon	Description	Refer to
	Call on hold	P.98 P.111
	Data upload	-
	Data download	-
	Application installed from Android Market	P.186
	Update of Android Market application available	P.186
	Hidden notification	P.52
	microSD card unmounted	P.138
	Watching a 1Seg program	P.200
	Connecting to data broadcast security page	P.201
	eco mode	P.217
	Positioning error (failure to get desired information)	P.192
	Communication disabled (failure to get desired information)	P.192
	Communication error (failure to get desired information)	P.192
	Last train alarm set	P.192

■ Main status icons

Icon	Description	Refer to
 *1	Radio wave strength	-
 *1	Roaming	P.224
	Out of service area	-
 *1	Connecting to GPRS	P.227
 *1	GPRS in use	P.227
 *1	Connecting to EDGE	P.227
 *1	EDGE in use	P.227
 *1	Connecting to 3G (packet)	P.227
 *1	3G (packet) in use	P.227
	Flight mode	P.116

Icon	Description	Refer to
 *1	Connecting to Wi-Fi	P.89
	Bluetooth ON	P.168
	Bluetooth device connected	P.168
	Data sync	P.135
	UIM not installed	P.35
	Alarm set	P.211
	Speakerphone ON	P.98
	Microphone mute	P.98
	Silent mode (vibration ON)	P.122
	Silent mode (vibration OFF)	P.97
	Charge required	P.41
	Low battery	P.41
	Sufficient battery	P.41
	Charging	P.41
	GPS positioning	P.126

*1 Network icons appear in white when Google account is not set or [Background data] in Accounts & sync settings is unmarked.

Notification Panel

When notification icons are displayed, you can open the notification panel to check notifications of messages, Calendar events, and so on.

Opening Notification Panel

1 Drag the status bar downward

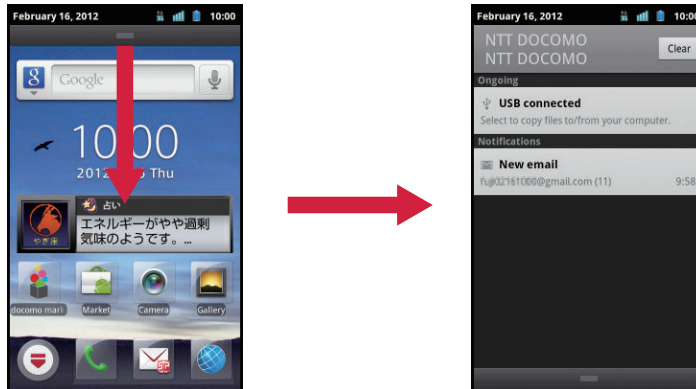

- Tap a notification to check details or configure necessary settings.
- Tap [Clear] to clear all items in the notification panel. However, some items may not be cleared.

Closing Notification Panel

1 Drag the bar at the bottom of the notification panel upward, or press

Character Entry

With this mobile phone, you can enter characters by tapping the text entry field and using the keypad displayed. You can also enter characters with handwriting.

Switching Input Method

Any of three input methods can be used to enter characters with this mobile phone.

- 1 Touch and hold the text entry field
- 2 [Input Method] ► [Android keyboard]/[Fit Key]/[Quick Handwriting]

Entering with Fit Key

You can select from the two keypad types below:

- **Ten-key keypad**

Used for Japanese Kana input.

- **QWERTY keypad**

Used for Japanese Romaji input.











Entering Characters with Ten-key Keypad

- 1 Tap the text entry field ► Touch and hold  in the keypad

2 [10-key ⇔ QWERTY]

- To close the keypad, press .



<p>1</p> <p>: Hiragana-Kanji : Full-width Katakana : Half-width Katakana : Full-width Alphabet : Half-width Alphabet : Full-width Numeric : Half-width Numeric : Pictogram/Symbol</p>	<p>Indicates the currently used input mode.</p>
<p>2</p>	<p>The character assigned to the key concerned is input. Tap a key repeatedly until desired character is displayed, or touch and hold a key and flick to desired character.</p>
<p>3</p>	<p>Alphabet/Numeric/Pictogram or symbol/Kana input modes are switched each time the key is tapped.</p> <p>Touch and hold the key  [10-key ⇔ QWERTY] to switch between ten-key keypad and QWERTY keypad for each input mode.</p> <p>Touch and hold the key  [Input Mode] to switch Full-width/Half-width.</p> <p>When you have entered characters, tap to switch the characters between uppercase and lowercase characters, or enter "¨ " and "° ".</p>
<p>4</p>	<p>Delete a character at the left of the cursor.</p>
<p>5</p>	<p>Flick to desired direction and move the cursor in four directions.</p>

6	<p>Insert a space.</p> <p>When this key is tapped with characters entered, conversion candidates are displayed. Flick left to display characters in reverse order.</p> <p>Flicking to left the key right after confirming entered characters returns the characters to unconfirmed state.</p>
7	<p>Confirm entered characters or feed a new line.</p> <p>The function now activated is executed using the characters which have been input.</p>

Entering Characters with QWERTY Keypad

1 Tap the text entry field ► Touch and hold  in the keypad

2 [10-key ⇔ QWERTY]

- To close the keypad, press .

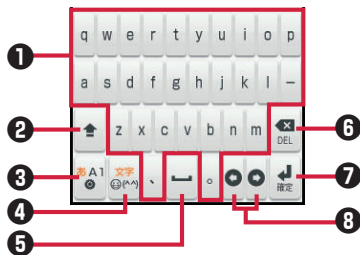

1	Enter characters indicated on the keys.
2	Switch between uppercase and lowercase characters.
3	<p>Alphabet/Numeric/Romaji input modes are switched each time the key is tapped.</p> <p>Touch and hold the key ► [10-key ⇔ QWERTY] to switch between ten-key keypad and QWERTY keypad for each input mode.</p> <p>Touch and hold the key ► [Input Mode] to switch Full-width/Half-width.</p>
4	Switch to Pictogram/Symbol input modes.
5	Insert a space.
6	Delete a character at the left of the cursor.
7	Confirm entered characters or feed a new line.
8	Move the cursor right/left.

Entering Pictograms/Symbols

In the Pictogram/Symbol input mode, you can enter pictograms, symbols or emoticons. You might not be able to enter pictograms depending on the text entry field.

1 Tap  several times to switch to Pictogram/Symbol input mode

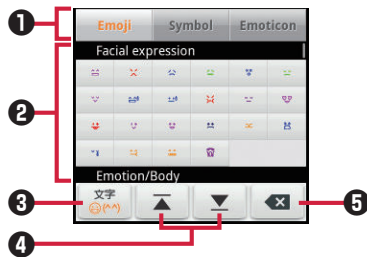

1	Switch pictogram/symbol/emoticon entering.
2	Scroll the screen up/down and tap a desired pictogram/symbol/emoticon. <ul style="list-style-type: none">The pictogram or symbol last used is displayed at the top of the list of pictograms or symbols.
3	End Pictogram/Symbol input mode.
4	Scroll the screen up/down. <ul style="list-style-type: none">On the pictogram list, you can scroll the screen up/down on a category by category basis.
5	Delete a pictogram/symbol/emoticon at the left of the cursor.

Entering Characters with Handwriting

1 Touch and hold the text entry field

2 [Input Method] ► [Quick Handwriting]

3 Tap the text entry field

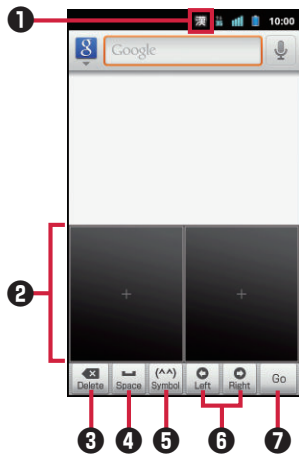

<p>1</p>	<p>The types of characters which can be entered are displayed here.</p> <p>漢: Kanji/Hiragana/Katakana/Alphabet/Numeric/Symbol あ: Hiragana/Katakana/Alphabet/Numeric A1: Alphabet/Numeric/Symbol 12: Numeric/Symbol</p> <ul style="list-style-type: none"> The types of characters are switched automatically depending on the application used.
<p>2</p>	<p>Enter characters in input frames with handwriting.</p> <ul style="list-style-type: none"> When a character input frame is pinched out/in, it can be switched to 1 frame, 2 frames or 6 frames.
<p>3</p>	<p>Delete a character at the left of the cursor.</p>
<p>4</p>	<p>Insert a space. When this key is tapped with characters entered, conversion candidates are displayed.</p>
<p>5</p>	<p>Switch to Pictogram/Symbol input modes. When this key is tapped with characters entered, switch Full-width/Half-width. To change Quick Handwriting settings, touch and hold the key ► [Change Settings].</p>

6	Move the cursor right/left. <ul style="list-style-type: none"> When the cursor is moved during character input, a list of recognition candidates for the handwritten character input is displayed.
7	Confirm entered characters or feed a new line. The function now activated is executed using the characters which have been input.

Character Entry Menu

Copy/Cut/Paste

- 1 Enter characters ► Touch and hold the text entry field
- 2 [Select word]/[Select all]
- 3 Drag the slider in four directions to select characters ► Touch and hold the text entry field
- 4 [Cut]/[Copy]
 - When pasting a copied character, move the cursor to the position where the character is to be pasted, touch and hold the text entry field ► Tap [Paste].

Character Entry Settings

You can configure various settings regarding character entry.

Fit Key Settings

- 1 Home screen ►  ► [Setting] ► [Language & keyboard] ► [Fit Key]

2 Perform operations listed below:

Sound on Key Press	Enable key-tapping sound.
Vibrate on Key Press	Enable key-tapping vibration.
Key Preview	Display key preview.
Auto Capitalization	Automatically capitalize the first character of a sentence in alphabet input mode.
Keyboard Type	Set keyboard type for each screen orientation and input mode.
Voice Input	Set whether or not to use voice input.
Flick Input	Enable flick input.
Flick Sensitivity	Specify flick sensitivity.
Toggle Input	Enable toggle input when flick input is enabled.
Auto Cursor Movement	Set the speed at which the cursor is to move automatically during character entry.
Input Word Learning	Learn converted words.
Word Prediction	Display conversion candidates as you enter characters.
Typing Error Correction	Display correction candidates for typing errors.
Wildcard Prediction	Predict conversion candidates from specified reading string length.
Lines of Candidate Area	Set the number of lines to be displayed in the candidate area.
Mushroom	Use mushroom applications.
Japanese User Dictionary	☞ P.61
English User Dictionary	Edit words in English User Dictionary.
Clear Learning Dictionary	☞ P.62



Download Dictionary	Set whether to enable dictionaries which were downloaded from websites.
iWnn IME	Version of iWnn IME etc. are displayed.

Quick Handwriting Settings

1 Home screen ►  ► [Setting] ► [Language & keyboard] ► [Quick Handwriting]

2 Perform operations listed below:

Input	Input Method	Set input frames number.
	Context Correction	Set whether to use the context correction function during character recognition.
	Automatic Fixation	Set the speed at which the input characters are confirmed. <ul style="list-style-type: none"> This can be set only when 1 frame input has been selected as the input method.
	Inputbox position	Set input frames position. <ul style="list-style-type: none"> This can be set only when 1 frame input has been selected as the input method.
	Japanese Address Input	Enable Japanese on URL/Email address.
	Full-width Space Input	Set whether to input spaces as full-width spaces during character entry.

Conversion	Word Prediction	Display conversion candidates as you enter characters.
	Input Word Learning	Learn converted words.
	Recognition Error Correction	Display the conversion candidates including the recognition error correction candidates.
	User Dictionary	 P.61
	Clear Learning Dictionary	 P.62
Sound on Operation	Sound on Key Press	Enable key-tapping sound.
Vibration	Vibrate on Writing	Set whether or not to vibrate when characters are entered in input frames.
	Vibrate on Key Press	Set whether or not to vibrate when a key is tapped.
Design	Background Color	Set input frames background color.
	Key Preview	Enlarge tapped keys during character entry.
Initialization		Restore the default Quick Handwriting settings. <ul style="list-style-type: none"> • Not clear learning dictionary and user dictionary.
Quick Handwriting		Version of Quick Handwriting etc. are displayed.

Adding Words to User Dictionary

You can add frequently-used words in Kana input mode to Japanese User Dictionary so that the added words are preferentially shown as conversion candidates when you enter the reading.

1 Home screen ►  ► [Setting] ► [Language & keyboard]

2 For Fit Key

[Fit Key] ▶ [Japanese User Dictionary]

- To add English words used in half-width alphabet input mode, tap [English User Dictionary].

For Quick Handwriting

[Quick Handwriting] ▶ [Conversion] ▶ [User Dictionary]

3 ▶ [Add]

4 Tap the text entry field of [Reading] ▶ Enter reading

5 Tap the text entry field of [Word] ▶ Enter word

6 [Save]

Clearing Learning Dictionary

Words and phrases you entered are automatically learned and displayed as conversion candidates by predictive conversion feature. When you clear the learning dictionary, learned words and phrases are all cleared and the dictionary is reset to the default status.

1 Home screen ▶ ▶ [Setting] ▶ [Language & keyboard]

2 For Fit Key

[Fit Key] ▶ [Clear Learning Dictionary]

For Quick Handwriting

[Quick Handwriting] ▶ [Conversion] ▶ [Clear Learning Dictionary]

3 [OK]

Customizing Fit Key

You can adjust the size and position of the keypad to fit on your hand. In addition, you can decorate the keypad with stamps and change the color, background and key shape.

1 Home screen ► [Fit Key]

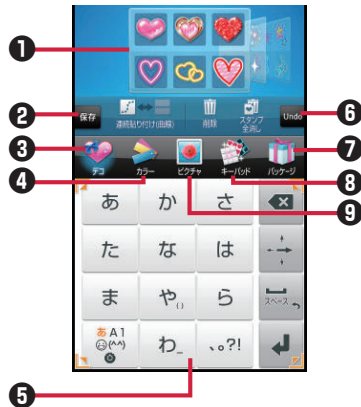

- ① Pallet
Flick right or left to select.
- ② Save the edited data.
- ③ Switch to the stamp setting screen.
- ④ Switch to the color setting screen.
- ⑤ Keypad preview
- ⑥ Undo one operation on the keypad.
- ⑦ Switch to the package setting screen.
- ⑧ Switch to the key shape setting screen.
- ⑨ Switch to the background setting screen.

2 Drag inward/outward the guide icons at four corners of the keypad preview to define the size ► Drag the keypad preview to define the position

- When the text entry field is hidden by the keypad or candidate display, you can display the text entry field by reducing the size of the keypad.

3 To attach stamps

[デコ (Deco)] ▶ Select a pallet ▶ Tap a stamp to attach ▶ Tap preferred location in the keypad preview to attach the stamp ▶ Perform stamp operations as necessary (👉 P.65)

To change color

[カラー (Color)] ▶ Select a pallet

- Drag the slider to adjust color transparency.
- Tap [グラデーション (Gradation) ON/OFF] to switch gradation/solid color.

To change background

[ピクチャ (Picture)] ▶ Select a pallet

- You can select from still images you recently saved in microSD card. To select from other still images, tap [すべて見る (View all)].
- Tap [背景写真をアクティブ (Activate background photo)] to adjust position of the still image.
- To shoot a still image for background, tap [カメラ起動 (Activate camera)] ▶ Display the object in the keypad preview ▶ 

To change key shape

[キーパッド (Keypad)] ▶ Select a pallet

To select from packages

[パッケージ (Package)] ▶ Select a pallet

- Tapping [初期状態に戻す (Initialize)] ▶ [Yes] will reset the keypad to the default state.
- You can receive/send the package via infrared communication by tapping [赤外線受信 (Receive via IrDA)]/[赤外線送信 (Send via IrDA)].
- You can load and select a package from microSD card by tapping [SDから読み込み (Load from SD)].
- When you tap [SDに保存 (Save in SD)], the package is saved in Packages folder of KeyboardCustomize folder in microSD card, and given a file name of the saved date and time (e.g., if a package is saved at 10:00:05 a.m. February 16, 2012, the file name of the saved package is "2012-02-16_10_00_05.pkg").
- You can delete package files saved in microSD card by connecting this mobile phone to a PC (☞ P.173).

4 When you finish editing, [保存 (Save)] ▶ [Yes]



Edited data is saved in this mobile phone and reflected in the keypad.

- Up to five packages can be saved in this mobile phone.

■ Stamp operations in keypad preview

When a stamp is tapped, the stamp guide is displayed around the stamp.

Operation	Procedure
Move	Display the stamp guide ▶ Drag the center of the stamp guide
Zoom in/out at the same magnification	Display the stamp guide ▶ Put your fingers around the stamp guide to pinch out/in
Increase/decrease height/width	Display the stamp guide ▶ Drag the stamp guide corner to increase/decrease height/width

Operation	Procedure
Rotate	Display the stamp guide ▶ Trace the outer side of the stamp guide corner in direction you want to rotate
Copy & paste	Display the stamp guide ▶ Touch and hold the center of the stamp guide ▶ Tap the location you want to attach the stamp
Delete	Display the stamp guide ▶ [削除 (Delete)] <ul style="list-style-type: none"> You can also delete a stamp by tapping [削除 (Delete)] ▶ Tap a stamp to delete.
Delete all	[スタンプ全消し (Erase all stamps)] ▶ [Yes]
Paste consecutively	Tap [連続貼り付け (Paste consecutively)] to select  (line)/  (curve) ▶ Select a pallet ▶ Tap a stamp to attach ▶ Trace the keypad preview

docomo Palette UI

Home Screen

Home screen is the start screen from which you can start using applications. Press  to display the home screen. You can choose from the following three home applications: docomo Palette UI, "Fit Home" and Launcher. This section describes how to operate docomo Palette UI.



① Indicators

Current location (sheet) within the home screen is indicated. You can use up to 12 sheets and switch the screens (sheets) by flicking the screen right and left.

② Quick search box (🔍 P.70)

③ Shortcuts, widgets, folders, groups and web pages can be freely placed in home screens.

④ This part is displayed on all sheets to show the application list screen.

⑤ Dook

This part is displayed on all sheets to place shortcuts, folders and groups.

Information

- If you change to a different home application, items on the screen such as widgets might not be displayed correctly depending on the home screen layout etc.

Adding Shortcuts etc. to Home Screen

1 Home screen ► Touch and hold the background

- Applications or groups can also be added by touching and holding the target application or group on the application list screen, and then by tapping [Add to home].

2 [Shortcut]/[Widget]/[Folder]/[Group]/[Web page]

3 Select a shortcut etc. to add

- Set the updating interval if [Web page] has been selected.

4 Touch and hold a shortcut etc. added to the home screen, and drag it to preferred location

Changing Folder Name

1 Tap a folder ► Touch and hold the title bar

2 Enter folder name ► [OK]

Deleting Shortcuts

1 Home screen ► Touch and hold a shortcut etc. to delete, and drag it into

- When the shortcut is dragged into , the color of the shortcut icon changes to red.

Changing Shortcuts etc. in a Dock

1 Home screen ► Touch and hold a shortcut etc. and drag it in the dock

- To delete a shortcut in the dock etc. touch and hold the shortcut, and drag it into .

Uninstalling Applications or Widgets

1 Home screen ► Touch and hold an application or a widget to uninstall ► [Uninstall] ► [OK]

- Applications can also be uninstalled by touching and holding the target application on the application list screen, and then by tapping [Uninstall] ► [OK].

Changing Wallpaper of Home Screen

1 Home screen ► Touch and hold the background ► [Wallpaper]

2 Tap a wallpaper type ► Select an image

- If an image has been selected using [Gallery], decide on the trimming position, and then tap [Save] to complete the setting.

3 [Set wallpaper]

Adding Home Screens

1 Home screen ►  ► [Home screen list] ► [+]

- [+] is displayed if the home screen is less than 11 sheets.

2 Touch and hold the home screen, and drag it to preferred location

- To delete a home screen, touch and hold the home screen, and drag it into .

Searching for Mobile Phone Applications and Web Page Information

1 Home screen ▶ Tap the entry field within the quick search box

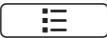
- You can also search by displaying the application list screen ▶  ▶ [Search].
- Press  ▶ [Search settings] to change search target types and settings.

2 ▶ Tap a search target ▶ Enter keyword

Search candidates that contain characters you just entered appear.

3

Application Screen

Displaying Application List Screen

On the application list screen, the installed applications are displayed on a group by group basis.

1 Home screen ▶ 



















- 1 The group names and number of applications are displayed. Tap a group to switch between displaying and hiding the application icons.
- 2 Show the application list for each group.











List of Applications















The following is the list of applications that are preinstalled in the mobile phone at the time of purchase.















- To use some applications may require the separate subscription (charged).
- Before using some applications for the first time, it may be necessary to install them from Android Market.
- Some applications do not work without microSD card. Install a microSD card when using applications.











Icon	Application	Description	Refer to
	BeeTV	BeeTV is a broadcast station dedicated for mobile phones. You can view original drama, music, and variety programs.	-
	BOOKストア 2Dfacto (Book Store 2Dfacto)	Electric book store in which you can buy and view various electric books including serious literary works, popular comics, and hot business books.	-
	Catalyst Reader	View Office documents and PDF files.	P.220
	docomo災害用伝言板 (docomo Disaster Message Board Service)	This is a disaster message board application. It allows your personal safety to be registered and checked at times when a disaster has occurred.	-
	Evernote	Save various information (website contents, photos, idea memos, etc.) to a server, and search and view it whenever you need. You can save and view information from a PC and other devices, as well as from this mobile phone.	-
	Facebook	Sign in to Facebook for news feed check, posting, message exchange and photo sharing.	-



Icon	Application	Description	Refer to
	Future Plus	Check desired information, Twitter updates, new messages (SMS), sp-mode mails, etc. on the same screen.	P.189
	Gmail	Exchange mails of Google account.	P.151
	GREE for P	This allows you to conduct simple searches for games of "GREE", which has more than 26 million users, and provides a wide range of applications in addition to its SNS function.	-
	Gガイド番組表 (G-Guide EPG)	View electronic program guide of terrestrial and BS digital broadcasts. You can search programs by keyword and by category.	-
	i チャンネル (i-channel)	An application, which allows you to use i-channel.	-
	Latitude	Share location information with friends on a map.	P.198
	mixi	An official application of "mixi" that allows you to share photos, chat and communicate with friends in other ways with more fun and style.	-
	Mobage	An application, which allows you to enjoy content provided by Mobage.	-
	My docomo アプリ (My docomo appli)	An application, which allows you to easily view information such as your usage fees and your docomo points.	-
	NAVITIME	You can use transit guide, train service information and map search features.	-
	Psmart	Access the manufacturer's website to get contents and information.	-

Icon	Application	Description	Refer to
	SD backup	Back up and restore phonebook, messages (SMS) and bookmarks to/from microSD card.	P.222
	spモードメール (sp-mode mail)	Exchange mails using docomo mail address (@docomo.ne.jp). You can use Pictograms and Deco-mail, and automatic reception is also supported.	P.144
	Twitter	A Twitter official client application. Post short messages on the website and communicate with people.	-
	VirusScan (docomo security scan)	An application protects your mobile phone from damage of virus. Search virus hidden in installed applications or in a microSD card, etc.	-
	YouTube	You can play videos from and post files to YouTube.	P.208
	あんしんモードアプリ (Security mode appli)	This application allows you to limit installation and running of applications, making and receiving calls, and access to the internet via Wi-Fi, so that even children can use this device securely.	-
	ウェザーニュースタッチ (Weather news touch)	View weather forecasts throughout Japan and live shows.	-
	ECONAVI	By adjusting various settings such as display brightness, an application sets "eco mode" to reduce battery consumption.	P.217
	Area Mail	An application, which allows you to receive Early Warning "Area Mail", or check received Area Mail messages.	P.154
	Camera	Shoot still images and videos.	P.175

Icon	Application	Description	Refer to
	Calendar	Manage schedule.	P.213
	Gallery	View still images and videos.	P.181
	ぐるなび (Gurunavi)	Search for restaurants by area, cuisine and budget, etc.	-
	Downloads	Files downloaded from websites are listed.	P.161
	Task Viewer	You can check and terminate running applications.	-
	Talk	You can chat with people using Google Talk.	P.156
	docomo market	Access docomo market to search for applications and videos.	P.188
	ドコモ海外利用 (docomo Overseas Use)	This application supports packet communication while overseas. When using data roaming settings, or Global Pake-hodai, you can easily set compatible operators.	-
	ToruCa	Inport/view/find/update etc. ToruCa data.	P.207
	Navigation	Direction to the destination is provided.	P.198
	News & Weather	View weather forecast and news.	P.209
	バーコードリーダー (Barcode Reader)	Read barcodes and QR codes with the camera.	P.218
	Fit Key	Adjust size and position of the keypad to fit on your hand. In addition, you can decorate the keypad.	P.63
	Browser	You can browse web pages as you do with a PC.	P.159
	Places	Search for stores and facilities near your location by category.	P.197

Icon	Application	Description	Refer to
	Voice Dialer	Just say the name of the other party to call up the contact and make a call.	P.104
	Home Switcher	An application, which allows you to switch home applications.	-
	Market	Use Android Market.	P.186
	マクドナルド Launcher (McDonald's Launcher)	You can use coupons for McDonald's and store locator.	-
	Maps	You can locate your current position, and search for places and routes to destinations.	P.197
	Email	Exchange Emails with PCs, etc.	P.148
	Messaging	Exchange messages (SMS).	P.145
	melodycall	An application, which allows you to use melodycall.	-
	1Seg	You can watch 1Seg.	P.199
	Music	Play music.	P.183
	Voice Search	Search for web page information by voice input.	-
	Google Search	Search for mobile phone applications and web page information.	P.70
	Koe no Takuhaibin	This applications allows the simple and convenient use of "Koe no Takuhaibin" by smartphone. You can record and play voice messages using simple commands.	-
	書籍・コミック E ★エブリスト (Books & Comics E★eburista)	You can read hot electric books and comics etc. from original works of professional writers and celebrities or popular works posted by general users.	-

Icon	Application	Description	Refer to
	Infrared	An application, which allows you to exchange data such as Phonebook etc. via infrared communication.	P.164
	Settings	Configure various settings of this mobile phone.	P.115
	地図アプリ (Map appli)	This application provides maps, a search function for stores and facilities, navigation, public transportation timetables, a record of places visited, and other functions to support you when you go out.	-
	Calculator	You can perform calculations such as addition, subtraction, multiplication and division.	P.216
	Phone	Make phone calls.	P.93
	Phonebook	Add and manage contacts in the phonebook.	P.100
	PhoneBookCopy	Using an external recording medium such as a microSD card, you can move or copy your phonebook.	P.105
	Phonebook backup	You can automatically back up contacts to the Phonebook backup center on a regular basis. Recover the data in case your mobile phone is lost or the phonebook data is accidentally deleted.	-
	Clock	On the clock screen, different types of information and shortcuts are shown along with the time. You can also set alarms.	P.211
	Instruction Manual	Instruction manual for this mobile phone. You can activate required functions directly from relevant descriptions.	P.2

Icon	Application	Description	Refer to
	毎日新聞 (The Mainichi Daily News)	View latest news stories provided by THE MAINICHI NEWSPAPERS.	-
	楽天 gateway (Rakuten gateway)	Allow easy access to all kinds of Rakuten services via the service launcher.	-
	楽天オークション (Rakuten auction)	This application lets you list items or place bids on Rakuten auction.	-

Moving an Application

- 1 Application list screen ► Touch and hold the application, and drag it to preferred location

Adding Groups

- 1 Application list screen ►  ► [Add group]

- 2 Enter a group name ► [OK]

- 3 Touch and hold the group, and drag it to preferred location

- To change the name or color of a group, touch and hold the group, and then tap [Edit name]/[Change color].
- To delete a group, touch and hold the group, and tap [Delete].

Changing the Layout of the Application List Screen

- 1 Application list screen ►  ► [List view]/[Tile view]

Home Application Settings

1 Home screen ►  ► [More] ► Perform operations listed below:

Home Settings	Set Version check etc.
Application info	Display the version of home application etc.

Initial Setting

Initial Setting

When you turn on the power of this mobile phone for the first time after purchase, configure settings for Google account and GPS positioning by following the on-screen instructions.

1 [言語変更] ▶ [English (United States)]

- If [機能バージョンアップ (Update features)] screen is displayed during initial setting, tap [OK] to return to the previous screen and continue operation.

2 Tap the Android logo ▶ [Create]

- If you already have a Google account, tap [Sign in].
- If you do not set a Google account, tap [Skip].

3 Enter your first name, last name, and desired username (part before @gmail.com) for the Google account ▶ [Next]

4 Enter a password ▶ Enter the password again for confirmation ▶ [Next]

5 Select a security question ▶ Enter answer in the answer field ▶ Enter a mail address you already have in the secondary Email field

- In case you forget your password, you can make it sent to your secondary mail address by matching the security question and answer in the Google website.

6 [Create]

7 Read Google Terms of Service ▶ [I agree, Next]

8 Enter characters indicated in the picture

▶ [Next]

9 Read the note about Google location service

▶ [Next]

- To make your data backed up in the Google server with your Google account, mark the checkbox.

10 [Next] ▶ [Finish setup]

Changing Screen Display to English

If you have not changed the display language to English in the initial setting, you can do it by following the steps below.

- 1 Home screen ▶  ▶ [本体設定] ▶ [言語とキーボード] ▶ [言語を選択] ▶ [English (United States)]

Google Account

Once Google account is set, you can download applications from Android Market. If you already have your own Google account, you can use the existing account with this mobile phone.

1 Home screen ►  ► [Setting] ► [Accounts & sync] ► [Add account]

2 [Google] ► [Next] ► [Create]

- If you already have your own Google account, tap [Sign in].

3 Take step 3 to 8 in P.80 "Initial Setting"

4 Mark data items to be synced ► [Finish] ► [Finish setup]

Setting Access Point

Access points for Internet connection (sp-mode and mopera U) are added by default. You can add and modify access points as necessary.

- By default, sp-mode is selected as default access point. However, the settings may differ depending on the terms set forth in your contract.

Checking Access Point in Use

- 1 Home screen ►  ► [Setting] ► [Wireless & networks] ► [Mobile networks] ► [Access Point Names]

Setting Additional Access Point

- Do not change MCC to other than 440, or MNC other than 10. If you change MCC/MNC, the access point will no longer be displayed on the screen.

- 1 Home screen ►  ► [Setting] ► [Wireless & networks] ► [Mobile networks] ► [Access Point Names]

- 2  ► [New APN]

- 3 [Name] ► Enter the name of network profile to create ► [OK]

- 4 [APN] ► Enter an access point ► [OK]

- 5 Enter other items required by the network operator ►  ► [Save]

- If MCC or MNC has been changed and the access point is not displayed on the screen, reset access point settings to the default status, or manually configure the access point.

Resetting Access Point

Resetting the access point restores the default status.

1 Home screen ▶  ▶ [Setting] ▶ [Wireless & networks] ▶ [Mobile networks] ▶ [Access Point Names]

2  ▶ [Reset to default]

sp-mode

sp-mode is an ISP for NTT DOCOMO smartphones. In addition to the Internet connection, you can use mail service with the same mail address (@docomo.ne.jp) as that of the i-mode. sp-mode is a pay service requiring subscription. For details of sp-mode, refer to DOCOMO website.

mopera U

mopera U is NTT DOCOMO's ISP. Subscribers for mopera U can use the Internet with simple settings. mopera U is a pay service requiring subscription.

Setting mopera U

1 Home screen ▶  ▶ [Setting] ▶ [Wireless & networks] ▶ [Mobile networks] ▶ [Access Point Names]

2 Mark [mopera U (Smartphone Fixed Rate)]/
[mopera U Settings] checkbox

Information

- [mopera U Settings] is an access point for mopera U setting. Connection via the access point for mopera U setting costs no packet communication fee. Note that you cannot access the screens other than those for initial settings and changing settings. For details of mopera U setting, refer to mopera U website.
- To use [mopera U (Smartphone Fixed Rate)], subscription to flat-rate packet service is required. For details of mopera U (スマートフォン定額) (flat-rate for smartphone), refer to DOCOMO website.

Email Setting

You can configure mail account provided by mopera U or general providers to use mail function.

- Configure access point setting in advance (☞ P.84).

Setting mopera U Mail Account

Subscribers for mopera U can use mopera U mail.

■ To use POP server

- 1** Home screen ▶  ▶ [Email]
- 2** Enter mopera U mail address and mopera U password ▶ [Next] ▶ [POP3]
- 3** Enter mopera U user name and password ▶
Enter [mail.mopera.net] for POP3 server
- 4** Select [None] or security type in the security type field ▶ Confirm your entry ▶ [Next]
- 5** Enter [mail.mopera.net] for SMTP server ▶
Confirm mopera U user name and password you entered ▶ [Next]
- 6** Option setting screen ▶ Set frequency of automatic mail check etc. ▶ [Next]
- 7** Mail account register screen ▶ Enter the name displayed for the sent message ▶ [Done]

Setting General Provider's Mail Account



- Obtain information required for settings from your service provider in advance.

1 Home screen ►  ► [Email]

2 Enter mail address and password ► [Next]

3 Follow on-screen instructions

Information

- If automatic settings of mail account does not complete, tap [Manual setup] in step 2 to enter the account setting information manually.
- To add another mail account, display the mail list screen ►  ► [Accounts] ►  ► [Add account].

Wi-Fi

You can use mail and the Internet by connecting to your home or corporate network or a public wireless LAN access point using the Wi-Fi function of this mobile phone.

1 Home screen ► ► [Setting] ► [Wireless & networks] ► Mark [Wi-Fi] checkbox

Wi-Fi is turned on and available Wi-Fi networks are detected.

2 [Wi-Fi settings]

Network name and security settings (open network or security protected) of each detected Wi-Fi network are displayed in the Wi-Fi network list.

- To manually add a Wi-Fi network, [Add Wi-Fi network] ► Enter required information ► Tap [Save].

Select security setting from [Open]/[WEP]/[WPA/WPA2 PSK].

3 Select Wi-Fi network ► [Connect]

- If you select a security-protected Wi-Fi network, enter the password (security key) and tap [Connect].
- To disconnect from the Wi-Fi network which is now connected, select the Wi-Fi network, and then tap [Forget].

Information

- You can also use packet communication when the Wi-Fi function is enabled. However, Wi-Fi is given priority when the mobile phone connects to Wi-Fi network. If the mobile phone is disconnected from the Wi-Fi network, 3G/GPRS network connection will automatically take over. Note that packet communication fee will be charged if you continue using the network connection.

■ Available channels

The Wi-Fi function of this mobile phone can use the frequency bands of channels 1 to 11.

■ Radio wave interference with Bluetooth devices

Wireless LAN (IEEE802.11b/g/n) and Bluetooth devices use the same frequency band (2.4 GHz). As such, when using the mobile phone near a Bluetooth device, radio wave interference may occur, causing a drop in the communication speed and/or resulting in noise or a connection failure. In cases like this, take the following action.

- Place the Bluetooth device at least 10 meters away from the mobile phone.
- If you must use the mobile phone within 10 meters of the Bluetooth device, turn off the power of the Bluetooth device.

Scanning Wi-Fi Networks

Turn on Wi-Fi in advance.

1 Home screen ▶  ▶ [Setting] ▶ [Wireless & networks] ▶ [Wi-Fi settings]

2  ▶ [Scan]

Wi-Fi network scanning starts, and the detected Wi-Fi networks are displayed on the Wi-Fi network list.

Setting Behavior in Sleep Mode

You can set how the Wi-Fi function is to operate when Sleep mode is set or during charging.

1 Home screen ▶  ▶ [Setting] ▶ [Wireless & networks] ▶ [Wi-Fi settings]

2  ▶ [Advanced] ▶ [Wi-Fi sleep policy] ▶ Select behavior to set

Checking MAC Address or IP Address

1 Home screen ▶  ▶ [Setting] ▶ [Wireless & networks] ▶ [Wi-Fi settings]

2  ▶ [Advanced]

"MAC address" and "IP address" are displayed.

Using Static IP Address

You can also connect to a Wi-Fi network by inputting its static IP address.

1 Home screen ▶  ▶ [Setting] ▶ [Wireless & networks] ▶ [Wi-Fi settings]

2  ▶ [Advanced] ▶ Mark [Use static IP] checkbox

3 Select [IP address] and other input items ▶ Enter required information ▶ [OK]

- To enable a static IP address, you must select settings for [IP address], [Gateway], [Netmask] and [DNS 1].

Online Service Accounts

You can set accounts of online services such as mixi and Twitter, and synchronize and exchange data between this mobile phone and each service server.

- To set Exchange account, check with your network administrator about setting information.

1 Home screen ►  ► [Setting] ► [Accounts & sync] ► [Add account]

2 Select a type of account to add ► Follow on-screen instructions

- Added account is displayed in the “Manage accounts” list. Tap an account to configure settings of each account.

Phone/Network Services

Phone

Making a Call

1 Home screen ►  ► [Phone] ► Enter the other party's phone number

- If you enter a wrong number, tap  to clear the entered number.

2 

3 To end the call, [End]

Emergency Call

Emergency call	Phone number
Call to police	110
Call to fire station and ambulance	119
Call for accidents at sea	118



- If UIM is not installed, it is not possible to make an emergency call at 110/119/118 in Japan.

- This mobile phone supports “Emergency Location Report”. When you make an emergency call such as at 110/119/118, information about the place where you are dialing from (location information) is automatically notified to emergency-response agencies such as police stations. It might happen that your correct location is not detected by emergency-response agencies depending on the location you dial from or radio wave conditions.
When you do not notify your phone number such as by adding “184” for each call, your location information and phone number are not notified. However, when an emergency-response agency has judged that the location information and phone number should be detected because of emergency priority such as for protection of human life, it might get location information and phone number regardless of your setting.
Areas and timing to introduce “Emergency Location Report” vary depending on the preparation of respective emergency-response agencies.
- When you make a call at 110/119/118 from this mobile phone, tell an operator that you are calling from a mobile phone, as well as your phone number and exact location, so that police/fire station can make a confirmation call to you.
In addition, stay at the current location while talking preventing the call from being disconnected. Do not turn off the power immediately, and make sure to place your phone standby for at least ten minutes after the call.
- You might not be connected to regional police/fire station depending on the area where you are calling from.
- When [Emergency call] is displayed on the screen, you can make an emergency call by tapping [Emergency call]. Note, however, that you cannot make an emergency call in Japan from the PIN code entry screen or PIN unblocking key (PUK) entry screen, or when the UIM is completely locked.

Selecting Whether to Notify or Withhold Caller ID for Each Call

- Caller ID is your important information. Be careful about notifying it.

1 Home screen ►  ► [Phone] ► Enter the other party's phone number

2  ► [Set Notify caller ID active] (186 added)/[Set Notify caller ID inactive] (184 added) ► 

Entering Push Signals

Push signals are used for operating home answer phone or for using services such as ticket reservation and bank balance check.

1 Home screen ►  ► [Phone] ► Enter phone number

2  ► [Add pause]
“,” is entered.

3 Enter push signals to transmit ► 

Push signals are automatically transmitted about two seconds after connection is made.

- If you select [Add wait] in step 2, “;” is added and you can transmit push signals manually. Transmit each signal after step 3.

Using International Call

- For overseas use,  P.224
- If you have any question about WORLD CALL, contact “General Inquiries” on the back page of this manual.

1 Home screen ▶  ▶ [Phone]

2 Enter + (touch and hold [0]) ▶ Country code ▶ Area code ▶ Phone number

- If the area code starts with “0”, omit “0”. However, “0” is necessary for some countries and regions such as Italy.

3 

Receiving a Call

1 A call comes in ▶ Drag  to the right

- To decline the call, drag  to the left.

2 To end the call, [End]

Information

- Answer holding feature is not available with this mobile phone.

Muting Phone Ringtone Temporarily

1 Incoming call ▶ / 

Silent Mode

When you set the Silent mode, any sound other than music, video and alarm is muted.

1 Press and hold  for at least one second ▶
[Silent mode]

Either  or  appears in the status bar depending on the vibration setting ( P.122).

- Setting the ringer volume to 0 by pressing  also sets the Silent mode.

■ To cancel Silent mode

1 In Silent mode ▶ Press and hold  for at least one second ▶ [Silent mode]

Information

- Shutter sound and recording start/end sounds of Camera are not muted in Silent mode.

Operations during Call



- ① : Hold the call.*1
- : Unhold the call.*1
- : Switch parties.*1*2

- ② End the call.
- ③ Make a call to another party.*1
- ④ Switch to hands-free call using a Bluetooth headset.*2
- ⑤ Display the dialpad to transmit push signals.*2
- ⑥ Mute the microphone so that your voice is not heard by the other party.*2
- ⑦ Turn the speakerphone on for hands-free call in which you hear the other party's voice from the speaker.*2

*1 Subscription to Call Waiting Service (📞 P.111) is required.

*2 Tap again to restore the previous state.

Information

- Voice input during call may generate noise or not be recognized properly.

Adjusting Volume of Other Party's Voice

1 During call ▶ (increase)/ (decrease)

Call Log

1 Home screen ► [Phone] ► [Call log] tab

The call log screen is displayed.

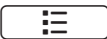
- To delete a call from the log, touch and hold the call to delete ► [Remove from call log].
To delete all calls from the log, display the call log screen ►  ► [Clear call log] ► [OK].

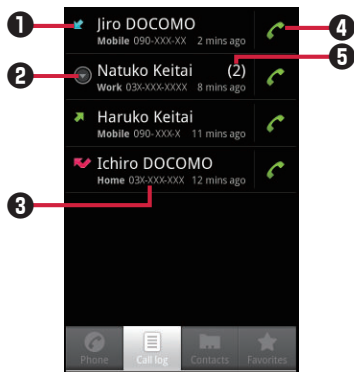

Call log screen

- ① : Outgoing call
- : Incoming call
- : Missed call
- : Rejected call

Indicates an incoming call from the phone number specified in the Call Reject setting ( P.120).

- ② Tap to open a group of calls.
Calls that you have made/received sequentially to/from the same name or phone number are grouped together and displayed.
- ③ Name and phone number
Tap to make a call, send a message (SMS), view contact details, or add a contact to the phonebook.
- ④ Tap to make a call.
- ⑤ Number of calls in a group



Phonebook

Adding a Contact to Phonebook

You can save names, phone numbers and mail addresses in the phonebook.

1 Home screen ►  ► [Phonebook] ► [New contact]

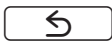

2 Enter necessary items

- Tap  to add an image. When an image shot using [Take photo] has been registered, both the image that was shot and the trimmed image are saved on the microSD card.
- Tap  to add/delete entries.
- To discard the entered contents, tap [Revert]. Pressing  does not discard the entered contents, but saves them to the phonebook.

3 [Done]

- If no contact is displayed, change marked items in the Display options setting ( P.102).

Adding a Contact to Favorites

1 Home screen ►  ► [Phonebook] ► Tap a contact to add ►  (gray) at the right of the name

 turns to blue and the added contact is displayed in the list in [Favorites] tab.

- For menu operations in the favorite list screen,  P.102

Checking Contacts

1 Home screen ► ► [Phonebook]

Contact list screen or favorite list screen is displayed.



Contact list screen

- 1 Tap the phone number to display My Details ( P.104).
- 2 Index bar
- 3 Tap to make a call or send a message (SMS).
- 4 Name
Tap to confirm details of the contact.
Touch and hold to edit/delete the contact.
- 5 Tap and select a group to display contacts by group.
- 6 Tap and enter keyword in the search box to sort out contacts.
- 7 Index
Scroll up/down and index bar of the character highlighted at the center is displayed at the top.

Information

- Contacts containing pictograms or unsupported characters may not be displayed correctly.

Contact List Screen/Favorite List Screen Menu

- 1 Contact list screen (▶ [Favorites] tab) ▶ 
▶ Perform operations listed below:

Display options*1	Select from display options: to show contacts accompanied by phone numbers only or contacts of marked items only.
Delete	Delete contact(s).
Group setting	Add/edit/delete group(s).
Accounts	Configure settings of Accounts & sync and add/manage online service account(s).
Import/Export	 P.102

*1 Unavailable in the favorite list screen.

Importing/Exporting Contacts

Contacts can be imported/exported between the UIM and this mobile phone.

■ Importing contacts

- 1 Contact list screen ▶  ▶ [Import/Export]
▶ [Import]

2 [Import from SIM card] ▶ Select an account

- 3 To import a contact
Touch and hold a contact to import ▶ [Import]
To import all contacts
 ▶ [Import all]

■ Exporting contacts

1 Contact list screen ►  ► [Import/Export]
► [Export]

2 **To export visible contacts**
[Share visible contacts] ► Select an application
► Follow on-screen instructions

To export all contacts via infrared communication

[Share all via IrDA] ► Enter 4-digit password ►
[OK] ► [Send]

- To send all contacts via infrared communication, the same 4-digit password has to be entered on the receiving terminal.
- Group names are not sent when exporting contacts by [Share visible contacts]. To include group names when exporting all contacts, use [Share all via IrDA], PhoneBookCopy (☞ P.105) or SD backup (☞ P.222).
- The exported contacts are saved to the docomo account on the receiving terminal.

My Details

The phone number of the mobile phone can be confirmed. You can also enter or edit your own details.

1 Home screen ►  ► [Phonebook] ► Tap the phone number in the My Details field

2  ► Perform operations listed below:

Edit contact	Edit My Details.
Share	Share My Details via infrared communication, etc.
Initialize	Restore all items in My Details to the default state except phone number.

Voice Dialer

You can make a call to a contact of the phonebook by speaking the name or phone number of the contact.

- Voice Dialer does not support Japanese.
- Some words you speak may not be recognized properly depending on its content.

1 Home screen ►  ► [Voice Dialer]

2 Say “Call” followed by the name of a contact, or “dial” followed by a phone number to the microphone

3 [OK]

PhoneBookCopy

By using microSD card you can exchange phonebook data with other mobile phones. In addition, you can copy the phonebook data added to your Google account to docomo account.

- If you use this function for the first time, you need to accept "License Agreement".

Exporting Phonebook to microSD Card

1 Home screen ▶  ▶ [PhoneBookCopy]

2 [エクスポート (Export)] tab ▶ [開始 (Start)]

Phonebook data saved in the docomo account is saved to microSD card.

Importing Phonebook from microSD Card

1 Home screen ▶  ▶ [PhoneBookCopy]

2 [インポート (Import)] tab ▶ Tap a file to import

3 [上書き (Overwrite)]/[追加 (Add)]

Imported phonebook data is saved to the docomo account.

Copying Contacts in Google Account to docomo Account

1 Home screen ►  ► [PhoneBookCopy]

2 [docomoアカウントへコピー (Copy to docomo account)] tab ► Tap Google account to copy

3 [上書き (Overwrite)]/[追加 (Add)]

Copied phonebook data is saved to the docomo account.

Information

- If the phonebook item names (Phone number, etc.) of the other mobile phone are not consistent with those of this mobile phone, item names may be changed or deleted. As characters available for contact information may vary depending on mobile phones, some characters may be deleted at the destination.
- When you export the phonebook data to microSD card, data without names cannot be copied.
- When you import the phonebook from microSD card, files created through [Batch backup] are not loaded.

Available Network Services

You can use the following DOCOMO network services on this mobile phone.

- Network services are unavailable when you are out of the service area or out of reach of radio waves.
- “Deactivating service” does not mean termination of subscription to services such as Voice Mail Service and Call Forwarding Service.
- This manual provides instructions for use of each network service from this mobile phone menu. For detailed information, refer to “Mobile Phone User’s Guide [Network Services]”.
- For application or inquiry, contact “General Inquiries” on the back page of this manual.

Service name	Monthly fee	Application	Refer to
Voice Mail Service	Paid	Necessary	P.107
Call Forwarding Service	Free	Necessary	P.109
Call Waiting Service	Paid	Necessary	P.111
Caller ID Notification Service	Free	Unnecessary	P.113
Public mode (power OFF)	Free	Unnecessary	P.113

Voice Mail Service

When you cannot answer a call because the mobile phone is turned off or out of reach of radio waves, or if you do not answer a call within a set ring time, this service answers the caller with an answering message and takes a message from the caller.

- Up to 20 messages can be stored, each of which can be recorded up to three minutes and stored for 72 hours.
- If the Voice Mail Service is “activated” and you do not answer a call, the call is recorded as a missed call in the call log and  appears in the status bar.
- This mobile phone is not compatible with the Videophone Voice Mail Service. Call “1412” and set it to “Deactivated”.

Basic Flow of Voice Mail Service

Step 1: Activate the service

Step 2: The caller records a message*1

Step 3: Play the message

*1 If the caller is in a rush and wants to skip the answering message to record a message immediately, he/she can do so by inputting “#” while the answering message is being played.

Using Voice Mail Service

1 Home screen ▶  ▶ **[Setting]** ▶ **[Call settings]** ▶ **[Network service settings]**

Network service settings screen is displayed.

2 [Voicemail] ▶ **Perform operations listed below:**

Activate voicemail	Activate the Voice Mail Service.
Deactivate voicemail	Deactivate the Voice Mail Service.
Set ring time	Enter the ring time (0 to 120 seconds). <ul style="list-style-type: none">• When the ring time is set to “0 second”, incoming calls are not recorded in the incoming call log.
Check voicemail settings	Confirm current settings.
Play messages*1	Play the message following audio guidance when you are connected to the Voice Mail Service center.
Voicemail setting*1	Change the settings following audio guidance when you are connected to the Voice Mail Service center.
Check messages*1	Check for messages.

Tone/ Vibration message notification	Sound is generated to notify of new message.
Activate missed call notification	If there was an incoming call while the mobile phone was turned off, out of service area, or during a call, a message (SMS) notifies you of the incoming call information. [For all calls]: Notifications of all incoming calls are provided. [For calls with Caller ID]: Notification of calls with caller ID only are provided.
Deactivate missed call notification	Deactivate the missed call notification.
Check missed call notification setting	Confirm the current missed call notification setting.

*1 You will receive message (SMS) "NTT DOCOMO VM:XX" after each operation.

Call Forwarding Service

When you cannot answer a call because the mobile phone is turned off or out of reach of radio waves, or if you do not answer a call within a set ring time, this service allows you to have the call forwarded to another phone number.

- If the Call Forwarding Service is "activated" and you do not answer a call, the call is recorded as a missed call in the call log and  appears in the status bar.

Basic Flow of Call Forwarding Service

Step 1: Register a forwarding phone number

Step 2: Activate Call Forwarding Service

Step 3: Your mobile phone receives a call

Step 4: The call is automatically forwarded to the forwarding phone number unless you answer it

Call Charges for Call Forwarding Service



- Charges for calls from the caller to the service subscriber shall be paid by the caller.
- Charges for calls from the service subscriber to a forwarding number shall be paid by the subscriber.

Information

- Even when the Call Forwarding Service is activated, you can answer a call while the ringtone is ringing.

Setting Call Forwarding Service

- 1** Network service settings screen ► [Call forwarding] ► Perform operations listed below:

Activate call forwarding	Enter a forwarding phone number and ring time (0 to 120 seconds) and activate Call Forwarding Service. <ul style="list-style-type: none">• Tapping  will call up the phonebook.• When the ring time is set to "0 second", incoming calls are not recorded in the incoming call log.
Deactivate call forwarding	Deactivate the Call Forwarding Service.
Change forwarding number	Change the forwarding phone number. <ul style="list-style-type: none">• Tapping  will call up the phonebook.
Setting if forwarding number is busy*1	Incoming calls are forwarded to Voice Mail Service center when the line of the forwarding number is busy.
Check call forwarding settings	Confirm current settings.

*1 Subscription to Voice Mail Service is required.

Setting Call Forwarding Announcement

You can turn on or off the voice announcement, which informs the caller that the call is being forwarded.

1 Home screen ►  ► [Phone] ► [1][4][2][9] ► 

- Configure settings following the audio guidance.

Call Waiting Service

If there is another incoming call during a call, this service notifies of it with a call waiting tone, and allows you to answer the new call by putting the current call on hold. You can also put the current call on hold and make a call to another party.

Information

- Even while the caller is put on hold, the caller is charged for the call.

Setting Call Waiting Service

1 Network service settings screen ► [Call waiting]

2 Activate/deactivate/check the settings of Call Waiting Service

Holding Call to Answer an Incoming Call

1 During call ► Beep sound is generated

Incoming call screen appears when you move your face away from the proximity sensor.

2 Drag  to the right

You can answer the second call by putting the first call on hold.

3 To end the second call

[End]

Connection is switched to the first call.

To hold the second call

 **(Swap)**

Connection is switched to the first call. Calls are switched each time you tap  (Swap).

Holding Call to Make Another Call

1 During call ▶ Tap (Hold)

The first call is put on hold.

2 [Add call] ▶ Enter another party's phone number ▶

You can talk with another party.

3 To end the second call

[End]

Connection is switched to the first call.

To hold the second call

 **(Swap)**

Connection is switched to the first call. Calls are switched each time you tap  (Swap).

Caller ID Notification Service

You can display your phone number on the other party's phone when you make a call.

- Phone number is your important information. Be careful about notifying it.

1 Network service settings screen ► [Notify caller ID]

2 Activate/deactivate/check the settings of Caller ID Notification Service

Information

- Setting for notifying/withholding caller ID for each call (☞ P.95) is given priority over setting of caller ID notification.

Using Public Mode (Power OFF)

When the public mode (power OFF) is set and you receive a call while the power is off or in Flight mode, an answering message is played telling the caller that you cannot answer calls since you are in a place where you must turn off the power (e.g. hospital, airplane, and near priority seats in a train), and the call automatically ends.

- If the public mode (power OFF) and network service are set at the same time, Voice Mail Service* or Call Forwarding Service* is given priority over the public mode (power OFF).
- * For calls with the ring time other than "0 second", the service is activated after answering message of the public mode (power OFF).

1 Home screen ►  ► [Phone]

2 To set public mode (power OFF)

[*][2][5][2][5][1]

The public mode (power OFF) is set (no change in the home screen).

To cancel public mode (power OFF)

[*][2][5][2][5][0]

To confirm public mode (power OFF) setting

[*][2][5][2][5][9]

3

When Public Mode (Power OFF) Is Set

The setting remains valid until you tap [*][2][5][2][5][0]

▶  to cancel public mode (power OFF). Turning the power on will not cancel the setting. An answering message that says you are in a place where the power must be turned off is played, and the call automatically ends.

The public mode (power OFF) answering message is played also when the mobile phone is out of service area or where radio waves cannot reach.

Various Settings

Setting Menu

Display home screen ►  ► [Setting] to call up the setting menu and configure various settings for this mobile phone.

- The setting menu can be displayed by displaying the home screen ►  ► [Settings].

Wireless & Networks

1 Home screen ►  ► [Setting] ► [Wireless & networks] ► Perform operations listed below:

Flight mode		Disable the wireless communication feature of this mobile phone. <ul style="list-style-type: none"> • Though marking [Flight mode] checkbox will turn off Wi-Fi, Wi-Fi tethering and Bluetooth functions.
Wi-Fi		☞ P.89
Wi-Fi settings	Network notification	Configure settings to provide notification when any open Wi-Fi network is detected.
	Add Wi-Fi network	☞ P.89
Bluetooth		☞ P.168
Bluetooth settings	Device name	☞ P.169
	Discoverable	☞ P.168
	Scan for devices	☞ P.168
Tethering & portable hotspot	USB tethering	☞ P.117
	Portable Wi-Fi hotspot	☞ P.118
	Portable Wi-Fi hotspot settings	☞ P.119
	Help	Display help information about tethering.
VPN settings	Add VPN	☞ P.171

Mobile networks	Data enabled	Enable Internet access via mobile networks.
	Data roaming	Enable connection to data services during roaming.
	Network Mode	☞ P.229
	Access Point Names	☞ P.84
	Network operators	☞ P.229

Using USB Tethering

You can connect a USB-compatible personal computer to the mobile phone using the microUSB cable supplied, and then use the mobile phone as a modem to connect to the internet.

1 Connect the mobile phone to a PC using the microUSB cable

- For how to connect the mobile phone to a PC, ☞ step 1 to 2 in P.173 "Connecting to a PC"

2 Home screen ► ► [Setting] ► [Wireless & networks] ► [Tethering & portable hotspot]

3 [USB tethering]

4 [Details] ► Read the content ► ► [OK]

USB tethering is enabled.

Information

- The following PC environments (OS) are required to use USB tethering. Proper operation is not guaranteed if the OS has been upgraded, added or modified.
Windows 7, Windows Vista, Windows XP (service pack 3 or later)
- Depending on the PC environment, it may be difficult to connect to the Internet or USB tethering may be disabled. In that case, enable USB tethering again and retry.
- A special driver is necessary to use USB tethering on a PC running Windows XP. For information about downloading the driver, etc., visit the following website:
<http://panasonic.jp/mobile/> (in Japanese only)
- If USB storage is turned on, you cannot use USB tethering.
Turn off USB storage (☞ P.174).

Using Wi-Fi Tethering

You can turn your mobile phone into a portable Wi-Fi hotspot to connect up to eight wireless LAN-compatible PCs, etc. simultaneously to the Internet.

1 Home screen ▶  ▶ [Setting] ▶ [Wireless & networks] ▶ [Tethering & portable hotspot]

2 [Portable Wi-Fi hotspot]

3 [Details] ▶ Read the content ▶  ▶ [OK]

Portable Wi-Fi hotspot is enabled.

Information

- If you start using Wi-Fi tethering without configuring portable Wi-Fi hotspot settings, the network SSID is "AndroidAP" and security is "Open". You can change the network SSID and configure security setting as required (☞ P.119).
- Turning on the Bluetooth function (☞ P.168) disables portable Wi-Fi hotspot.
- You can use both USB tethering and Wi-Fi tethering at the same time.

Setting Portable Wi-Fi Hotspot

1 Home screen ▶  ▶ [Setting] ▶ [Wireless & networks] ▶ [Tethering & portable hotspot]

2 [Portable Wi-Fi hotspot settings] ▶ [Configure Wi-Fi hotspot]

3 Enter necessary information

- You can set a password by selecting [WPA2 PSK] in the Security field.

4 [Save]

Call Settings

1 Home screen ►  ► [Setting] ► [Call settings] ► Perform operations listed below:

Fixed Dialing Numbers^{*1}	Enable FDN/Disable FDN	When FDN is turned on, you can call the phone numbers added to the FDN list only.
	Change PIN2	☞ P.130
	FDN list	Manage the phone number list. <ul style="list-style-type: none"> • Only single-byte characters and symbols can be used for names to be added to the list.
Network service settings	Voicemail	☞ P.107
	Call forwarding	☞ P.109
	Call waiting	☞ P.111
	Notify caller ID	☞ P.113
Call Reject	Reject call	Reject calls from specified phone numbers.
	Reject unknown	Reject calls from phone numbers not listed in the phonebook.
	Edit Registered list	Add/change/delete item(s) in the Edit Registered list.
International dial assist		A selection screen in which you choose whether or not to add Japan country code appears when you make a call from outside of Japan.
Accounts		Tap [Add account] to set SIP account to make an Internet call. Further, mark [Receive incoming calls] checkbox to receive Internet calls.

Use Internet calling

Set whether or not to use Internet calling while connected to Wi-Fi network.

*1 Not available with a DOCOMO UIM.

Sound

1 Home screen ►  ► [Setting] ► [Sound]

Sound settings screen is displayed.

2 Perform operations listed below:

Silent mode	Set/cancel the Silent mode.
Vibrate	Set whether to keep vibration always on/off, or to turn it on only when the Silent mode is set/canceled.
Volume	 P.122
Phone ringtone	Set the phone ringtone.
Notification ringtone	Set the notification ringtone that sounds upon reception of a message (SMS), etc.
Audible touch tones	Set the phone dialpad tones on/off.
Audible selection	Set the menu selection tones on/off.
Screen lock sounds	Set whether or not the tones sound when the screen is locked/unlocked.
Haptic feedback	Set the vibration upon certain screen operations on/off.

Adjusting Volume



Phone ringtone, notification ringtone, media sound and alarm volume can be adjusted.

1 Sound settings screen ► [Volume] ► Drag appropriate sound slider to right/left

- When the [Use incoming call volume for notifications] checkbox is unmarked, the notification ringtone slider is displayed, and you can adjust the phone ringtone and notification ringtone separately.

2 [OK]

Information

- Ringer (ringtone) volume can be adjusted by /. Note that during music/video playback or 1Seg watching, these keys are used as volume keys for the respective functions.



Display

1 Home screen ►  ► [Setting] ► [Display]
► Perform operations listed below:

Brightness	Set the brightness.
Auto-rotate screen	Vertical/horizontal display modes are automatically switched according to the direction of mobile phone.
Animation	Set whether or not to use animation to indicate screens and items.
Screen timeout	Set the time length before the mobile phone automatically enters the Sleep mode when it is not being operated.
Font setting	Set the font used in this mobile phone.
Proximity Sensor	Enable the sensor that prevents false operation of the touch panel during call.
Dominant hand setting	Set user's dominant hand. <ul style="list-style-type: none">• The setting applies to Future Plus and the contact list screen in the Phonebook.

Location & Security

1 Home screen ►  ► [Setting] ► [Location & security] ► Perform operations listed below:

Use wireless networks	Search for the present location based on information acquired from Wi-Fi and mobile network base stations.
Use GPS satellites	Measure more accurate location information. <ul style="list-style-type: none"> • Excellent visibility is required, and battery consumption is increased. It is recommended to use with wireless networks.
Set up screen lock	 P.132
Set up SIM card lock	 P.129
Terminal password setting	 P.133
Visible passwords	Set whether characters are shown or hidden when you enter the password.
Select device administrators	Add/remove device administrators.
Use secure credentials	Enable credentials and certificates by permitting mobile phone application to access to the password-protected credentials storage.
Install from SD card	Install encrypted certificates from microSD card.
Set password	Set/change credentials storage password.
Clear storage	Clear all credentials and certificates from the credentials storage and reset the storage password.

About GPS

- GPS is a function to obtain location information of this mobile phone by receiving radio waves from GPS satellites.
- This cannot be used as navigation equipment for airplane, vehicle or person, or as high-accuracy surveying GPS. Note that we do not take any responsibility for a loss, such as pure economic loss resulting from use of GPS function for these purposes, or the facts that you have missed the chance to check the positioning (communication) results, which have been caused by external factors such as malfunctions, erroneous operations, or power failure (including battery shortage) on this mobile phone.
- GPS is operated by the United States Department of Defense, so the GPS radio wave conditions might be controlled (accuracy deterioration, radio wave supply suspension, etc.) depending on the defense strategy of the United States Department of Defense. Further, the result may vary even when positioning is performed in the same location and environment since radio wave conditions change along with movement of satellites.
- GPS uses radio waves from artificial earth satellites. Therefore, error in location information may be larger than 300 m as it may not/poorly receive radio waves under following conditions:
 - Among or under densely planted trees, high-rise buildings and dense residential area
 - Inside or very close to a building
 - Underground, tunnel, subterranean area and under water
 - Near high-tension wire
 - In a vehicle or train
 - In bad weather (heavy rain and snow)
 - In a bag or box
 - Surrounded by objects (including people)

Security Codes Used in this Mobile Phone

Some of the functions for convenient use of this mobile phone requires security codes, including mobile phone screen unlocking code and network security code for network services. Use appropriate security codes to handle this mobile phone.

■ Caution on security codes

- You should avoid using the numbers for security codes such as denoting your birth date, part of your phone number, local address number, room number, "1111" or "1234" that is easily decoded by a third party. Also make sure that you take a note of the security codes you have selected just in case you forget them.
- Take care not to let others know your security codes. If your security codes are known and used by a third party, we at DOCOMO take no responsibility in any event for the resultant loss.
- If you do not remember your respective security codes, you need to bring an identification card such as your driver's license, this mobile phone and UIM to the handling counter of a docomo Shop. For details, contact "General Inquiries" on the back page of this manual.
- The PIN unblocking key (PUK) is described on the application form (your copy) that is handed over to you at a docomo Shop at the time of contract. If your contract has been made at a shop other than a docomo Shop, you need to bring an identification card such as your driver's license, and the UIM to the handling counter of a docomo Shop, or contact "General Inquiries" on the back page of this manual.

Screen Locking PIN/Password

These are security codes for screen lock function for this mobile phone. PIN may be any number with four or more digits while the password may be any number with four or more digits with at least one alphabet character (👉 P.132).

Terminal Password

This is a four-to-eight digit number required for mobile phone resetting or when the password manager is launched by other applications (👉 P.133).

Network Security Code

This is a four-digit number required for your identification when you place an order at a docomo Shop or docomo Information Center, or when you use network services. This number is determined at the time of contract and you can also change the number later by yourself.

If you have “docomo ID/password” for the general support site for PC users “My docomo”^{*1}, you can set a new network security code from a PC.

***1** For details on “My docomo”, refer to the page just before the back page of this manual.

PIN1 Code/PIN2 Code

Two security codes are provided for the UIM, namely the PIN1 code and PIN2 code. These security codes are set to “0000” by default, but you can change the numbers later (👉 P.129).

The PIN1 code is a four-to-eight digit number (code) for checking the user each time the UIM is installed or each time mobile phone is turned on, to prevent the unauthorized use by a third party.

You can make/receive calls and operate the mobile phone by entering the PIN1 code.

- If you use a UIM that you used for another mobile phone in this mobile phone, enter the PIN1/PIN2 codes you set for the old terminal. The codes are “0000” if you have not changed them.
- If you fail to enter PIN1/PIN2 code correctly three times in succession, PIN1/PIN2 code is locked and disabled. In this case, unlock the PIN1/PIN2 lock with “PIN unblocking key”.

PIN Unlocking Key

The PIN unlocking key (PUK) is the eight-digit number for releasing the blocked PIN1 code and PIN2 code. You cannot change this PIN unlocking key by yourself.

- If you fail to enter PIN unlocking key (PUK) correctly ten times in succession, the UIM is locked. In this case, contact a docomo Shop.

Setting PIN Code

Configure settings so that the mobile phone prompts you to enter PIN1 code at startup.

- 1** Home screen ►  ► [Setting] ► [Location & security] ► [Set up SIM card lock]

SIM card lock settings screen is displayed.

- 2** [Lock SIM card] ► Enter PIN1 code ► [OK]

[Lock SIM card] checkbox is marked.

Changing PIN1 Code

- 1** Perform step 1 to 2 in P.129 "Setting PIN Code"

- 2** [Change SIM PIN]

- 3** Enter current PIN1 code ► [OK]

- 4** Enter new PIN1 code ► [OK]

- 5** Enter new PIN1 code again ► [OK]

Unlocking PIN1 Lock

If you fail to enter PIN1 code correctly three times in succession, PIN1 is locked and [SIM card is PUK-locked.] appears. You can unlock PIN1 lock by following operations.

1 Drag  to the right

- When [Entering wrong number 10 times will cause SIM lock.] appears, tap [OK].

2 Enter PIN unblocking key (PUK) ► [OK]

3 Enter new PIN1 code ► [OK]

4 Enter new PIN1 code again ► [OK]

Changing PIN2 Code

1 Home screen ►  ► [Setting] ► [Call settings] ► [Fixed Dialing Numbers]

Fixed Dialing Numbers screen is displayed.

2 [Change PIN2]

3 Enter current PIN2 code ► [OK]

4 Enter new PIN2 code ► [OK]

5 Enter new PIN2 code again ► [OK]

- If you enter the current PIN2 code wrongly three times in succession and PIN2 is locked,  step 4 in P.131 "Unlocking PIN2 Lock"

Unlocking PIN2 Lock

If you fail PIN2 authentication three times in succession, and [Password incorrect, please change PIN2 and retry!] is displayed, perform the following procedure to unlock PIN2 lock.

- 1** Fixed Dialing Numbers screen ► [Change PIN2]
- 2** Enter new PIN2 code ► [OK]
- 3** Enter new PIN2 code again ► [OK]
- 4** Enter PIN unblocking key (PUK2) ► [OK]

Setting Screen Lock

This mobile phone can be locked with unlocking pattern, PIN or password to prevent unauthorized use by any third party.

1 Home screen ►  ► [Setting] ► [Location & security]

Location & security settings screen is displayed.

2 [Set up screen lock] ► [Pattern]/[PIN]/[Password] ► Follow on-screen instructions

- When the screen lock is set, you can set [Use tactile feedback] in Location & security settings screen. To have the mobile phone vibrate as you enter the pattern, PIN or password, mark the checkbox. If the pattern is set, you can also set [Use visible pattern]. Mark the checkbox to show the trace of your finger as it draws the pattern on the screen.

Disabling Screen Lock Setting

1 Location & security settings screen ► [Change screen lock]

2 Enter unlocking pattern, PIN or password ► [None]

Information

- When the power is turned on or Sleep mode is released, if you mistakenly enter the unlocking pattern five consecutive times, tap [Forgot pattern?] on the re-entry screen to log into your Google account, and follow on-screen instructions to create a new pattern. Only when you set a Google account, [Forgot pattern?] is displayed.
If you forget PIN or password, you cannot unlock the screen.

Setting Terminal Password

- 1** Home screen ►  ► [Setting] ► [Location & security]

Location & security settings screen is displayed.

- 2** [Terminal password setting]

- 3** Enter terminal password ► [OK]

- 4** Enter terminal password again ► [OK]

Changing Terminal Password

- 1** Location & security settings screen ► [Terminal password setting]

- 2** Enter current terminal password ► [OK]

- 3** Enter new terminal password ► [OK]

- 4** Enter new terminal password again ► [OK]

Applications

- 1 Home screen ►  ► [Setting] ► [Applications]

Application settings screen is displayed.

2 Perform operations listed below:

Unknown sources	Permit installation of applications obtained from websites other than Android Market or by mail. <ul style="list-style-type: none">• Download applications only from trusted sources such as Android Market to protect your mobile phone and personal information.
Manage applications	 P.134 <ul style="list-style-type: none">• Clear data and cache of applications.
Running services	Display/manage running services.
Storage use	Display application storage usage.
Battery use	Battery power consumption of each application can be confirmed.
Development	Set options available for application development.

Deleting an Installed Application

- 1 Application settings screen ► [Manage applications] ► [Downloaded] tab

- 2 Tap an application to delete ► [Uninstall] ► [OK] ► [OK]

Accounts & Sync

- 1 Home screen ►  ► [Setting] ► [Accounts & sync]

Accounts & sync settings screen is displayed.

2 Perform operations listed below:

Background data	Permit all applications installed in the mobile phone to automatically perform data communication.
Auto-sync	Permit applications to automatically perform data synchronization.
Add account	 P.92

Changing Items to Synchronize

- 1 Accounts & sync settings screen ► Tap the account ► Mark item(s) to synchronize only

Starting Manual Synchronization

- 1 Accounts & sync settings screen ► Tap the account to synchronize ►  ► [Sync now]

Stopping Synchronization

- 1 Synchronizing ►  ► [Cancel sync]

Removing an Account

Removing an online service account will also delete the account data saved in this mobile phone (messages, phonebook and settings).

- Data on the online service will not be deleted.

- 1 Accounts & sync settings screen ► Tap the account to remove ► [Remove account] ► [Remove account]

Information

- The Google account that was set first cannot be removed by [Remove account]. To remove the first Google account, reset the mobile phone (☞ P.137).
- The docomo account cannot be removed.

Privacy

1 Home screen ►  ► [Setting] ► [Privacy]

Privacy settings screen is displayed.

2 Perform operations listed below:

Back up my data	Back up application data and settings to Google server.
Automatic restore	Restore backup settings and data when an application is reinstalled.
Factory data reset	 P.137

Resetting Mobile Phone

You can reset this mobile phone to the default status.

- This operation deletes all the applications installed and data saved to this mobile phone after purchase, with some exceptions.

1 Privacy settings screen ► [Factory data reset] ► Enter terminal password ► [OK]

- If terminal password is not set,  step 3 to 4 in P.133 "Setting Terminal Password"
- To delete all data in microSD card, mark [Erase SD card] checkbox.

2 [Reset phone]

- If the screen lock setting is enabled, enter unlocking pattern, PIN or password.

3 [Erase everything]

Once reset, the mobile phone is restarted.

Storage

1 Home screen ►  ► [Setting] ► [Storage]

Storage settings screen is displayed.

2 Perform operations listed below:

Total space	Display total capacity of microSD card.
Available space	Display available space of microSD card memory.
Unmount SD card/Mount SD card	Securely remove microSD card from this mobile phone/Make this mobile phone recognize microSD card.
Erase SD card	 P.138
Available space	Display available space of this mobile phone memory.

Erasing All Data in microSD Card

1 Storage settings screen ► [Unmount SD card] ► [OK]

[Erase SD card] becomes selectable.



2 [Erase SD card] ► [Erase SD card]

- If the screen lock setting is enabled, enter unlocking pattern, PIN or password.

3 [Erase everything]

Language & Keyboard

1 Home screen ►  ► [Setting] ► [Language & keyboard] ► Perform operations listed below:

Select language	Set a display language.
User dictionary	Add words to the user dictionary for Android keyboard. ►  ► [Add] ► Enter a word ► [OK]
Fit Key	 P.58
Quick Handwriting	 P.60
Android keyboard	Configure settings for key tones and input assist function for Android keyboard. <ul style="list-style-type: none"> • [Auto-complete] is not enabled even when the checkbox is marked.

Voice Input & Output

1 Home screen ►  ► [Setting] ► [Voice input & output] ► Perform operations listed below:

Voice recognizer settings	Language	Set a language for voice text input.
	SafeSearch	Apply adult filter to voice search results.
	Block offensive words	Set to allow no offensive words to be displayed for voice text input.
Text-to-speech settings	Listen to an example	Play an example of speech synthesis.
	Always use my settings	The settings configured under [Default settings] are always used in other applications.
	Default Engine	Set a synthesis engine used for text-to-speech synthesis.
	Install voice data ^{*1}	If voice data necessary for text-to-speech synthesis is not installed, you can install voice data from Android Market. <ul style="list-style-type: none"> • No Japanese voice data is available.
	Speech rate	Set the speed at which the text is spoken.
	Language	Set a language used for text-to-speech synthesis.
	Pico TTS	Confirm the installed voice data.



*1 Not available if any voice data is installed.

Accessibility

1 Home screen ► ► [Setting] ► [Accessibility]

- When [No accessibility related applications found] appears, tap [OK] to install a screen reader from Android Market, or tap [Cancel].

2 Perform operations listed below:

Accessibility	Enable accessibility-related applications for audio and vibration responses to user operations and for text-to-speech service. Mark [Accessibility] checkbox, and then mark the checkboxes of the accessibility services you want to enable. <ul style="list-style-type: none">• To use text-to-speech service, voice data must be installed ( P.140).
Power button ends call	Allow to end call by pressing  .

Date & Time



This is set to [Automatic] by default. It is not necessary to set date and time manually.

1 Home screen ►  ► [Setting] ► [Date & time] ► Perform operations listed below:

Automatic	Date, time zone and time are acquired from the network and automatically corrected.
Set date	Set the date manually.
Select time zone	Set the time zone manually.
Set time	Set the time manually.
Use 24-hour format	Switch the time format to 24-hour format.
Select date format	Switch date display format.

About Phone

1 Home screen ►  ► [Setting] ► [About phone] ► Perform operations listed below:

Software Update	 P.248
Upgrade features	 P.260
Status	The remainder of the battery and phone number can be confirmed.
Battery use	Battery power consumption of each application can be confirmed.
Legal information	Open source licenses (including GPL/LGPL) and Google Terms of Service can be confirmed.
Model number	Model number can be confirmed.
Android version	Software version can be confirmed.
Baseband version	
Kernel version	
Build number	

Mail/Internet

sp-mode Mail

Exchange mails using i-mode mail address (@docomo.ne.jp). Pictograms, Deco-mail, and automatic reception features are available.

- For detailed information of sp-mode mail, refer to “ご利用ガイドブック (spモード編) (Mobile Phone User’s Guide [sp-mode])” (in Japanese only).



1 Home screen ▶  ▶ [spモードメール (sp-mode mail)]

2 Follow on-screen instructions

Message (SMS)

You can exchange text messages of up to 70 double-byte characters (160 single-byte characters if the message consists only of single-byte characters) using mobile phone numbers as addresses.

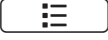
Creating and Sending a Message (SMS)

- 1** Home screen ▶  ▶ [Messaging] ▶ [New message]
- 2** [To] field ▶ Enter recipient's mobile phone number
- 3** [Type to compose] field ▶ Enter message
 - Press  to insert smileys that can be displayed on Android terminals.
 - To save a message (SMS) as a draft, press  twice after entering address and part of message.
- 4** [Send]

Information

- You can exchange messages (SMS) with subscribers of overseas operators. For available countries and overseas operators, refer to "Mobile Phone User's Guide [International Services]" or DOCOMO International Services website.
- To send a message (SMS) to a subscriber of an overseas operator, enter "+" followed by "country code" and "the other party's mobile phone number". If the mobile phone number starts with "0", omit "0". Alternatively, enter "010" followed by "country code" and "the other party's mobile phone number" (when replying to a message (SMS) from overseas, always enter "010").

Receiving and Reading a Message (SMS)

When you receive a new message (SMS), a notification icon is displayed in the status bar. You can check the message by opening the notification panel and tapping the notification.

1 Home screen ►  ► [Messaging]

Message list screen is displayed.

2 Tap a thread to read

Replying to a Message (SMS)

1 Message list screen ► Tap a thread to reply

2 Enter message ► [Send]

Forwarding a Message (SMS)

1 Message list screen ► Tap a thread to forward

2 Touch and hold a message (SMS) to forward ► [Forward]

3 Enter forwarding mobile phone number in [To] field ► [Send]

Deleting Messages (SMS)

1 Message list screen

2 To delete a message (SMS)

Tap a thread to delete ► Touch and hold a message (SMS) to delete ► [Delete message]

To delete a thread

Tap a thread to delete ►  ► [Delete thread]

- You can also touch and hold a thread to delete ► [Delete thread].

To delete all threads

 ► [Delete threads]

3 [Delete]

Setting Message (SMS) Options

1 Message list screen ►  ► [Settings]

- You can configure settings regarding automatic deletion of messages (SMS), notification, etc.

Email

You can use Email application by setting mail accounts provided by mopera U or other Email service providers.

- Set an access point (📶 P.84) and mail account (📶 P.87) in advance.

Creating and Sending an Email

1 Home screen ▶ ▶ [Email]

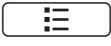
- To send Email from another mail account, press  ▶ [Accounts] and select a mail account in the account list screen.
- If the combined inbox is displayed, Email is sent from the mail account marked in the account list screen.

2 ▶ [Compose]

3 [To] field ▶ Enter mail address

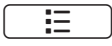
- To add Cc and/or Bcc, press  ▶ [Add Cc/Bcc].

4 [Subject] field ▶ Enter subject

5 [Compose Mail] field ▶ Enter message

- To attach a file, press  ▶ [Add attachment] ▶ select a file.

6 [Send]

Information

- Emails are regarded mails sent from PCs. If a recipient terminal is rejecting PC mails, you cannot send an Email to the recipient.

Receiving and Reading an Email

1 Home screen ► ► [Email]

Email list screen is displayed.

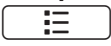
- If you have more than one mail account, press  ► [Accounts] and select a mail account in the account list screen.
- Tapping [Combined Inbox] in the account list screen will show an inbox for all mail accounts. Mail accounts are distinguished by a color bar at the left of each Email.

2 To refresh the inbox, ► [Refresh]

3 Tap an Email to read

Replying to an Email

1 Email list screen ► Tap an Email to reply ► [Reply]/[Reply all]

2 Enter message ► [Send]

Forwarding an Email

1 Email list screen ► Tap an Email to forward ► ► [Forward]

2 Enter forwarding mail address in [To] field ► [Send]

Deleting Emails

1 Email list screen

2 To delete an Email

Touch and hold an Email to delete

To delete multiple Emails

Mark Emails to delete

3 [Delete]

Switching Folder Display

1 Email list screen ►  ► [Folders]

2 Tap a folder to open

Setting Email Account Options

1 Email list screen ►  ► [Account settings]

- You can configure settings regarding signature, notification, etc.

Gmail

Gmail is Google's online Email service. You can exchange Emails using Gmail application on this mobile phone.

- Set your Google account ( P.83) in advance.

Refreshing Gmail

1 Home screen ►  ► [Gmail]

Inbox is displayed.

2  ► [Refresh]

Gmail application on the mobile phone is synchronized with your Gmail account to refresh the inbox.

Creating and Sending a Mail

1 Inbox ►  ► [Compose]

2 [To] field ► Enter mail address

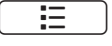
- To add Cc and/or Bcc, press  ► [Add Cc/Bcc].

3 [Subject] field ► Enter subject

4 [Compose Mail] field ► Enter message

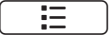
- To attach an image, press  ► [Attach] ► select an image.

5 

Displaying a New Mail

1 Inbox ► Tap a thread with any unread mail

- When a notification icon is displayed in the status bar, you can display the inbox by opening the notification panel and tapping the notification.

Searching for a Mail

1 Inbox ► ► [Search]

2 [Search mail] field ► Enter keyword ►

Replying to a Mail

1 Display a mail to reply

2 To reply to an address



To reply to all addresses



3 [Compose Mail] field ► Enter message

4

Forwarding a Mail

1 Display a mail to forward

2 ► [Forward]

3 [To] field ► Enter mail address

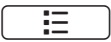
- To add Cc and/or Bcc, press  ► [Add Cc/Bcc].

4 [Compose Mail] field ► Enter message

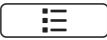
- To attach an image, press  ► [Attach] ► select an image.

5

Message Thread Operations

1 Inbox ► Touch and hold a thread ► Perform operations listed below:

Read	Unfold the thread.
Archive	Archive (store) the thread. Archived thread is not shown in the inbox.
Mute	Hide the thread. It is recommended to hide less important or unnecessary threads.
Mark unread/ Mark read	Mark the thread unread/read.
Delete	Delete the thread.
Add star/ Remove star	Add or remove a star to/from the thread.
Change labels	Add/modify labels of the thread. This helps grouping of mails.
Report spam	Report received mail as a spam.
Help	Google Mobile Help is displayed and you can check information of mobile software provided by Google.

Setting Gmail Options

1 Inbox ► ► [More] ► [Settings]

- You can configure settings regarding signature, font size, notification, etc.

Early Warning "Area Mail"

This service allows you to receive Earthquake Early Warnings or other disasters which are sent out by the Japan Meteorological Agency.

- Area Mail is a free service for which subscription is not required.
- You can save up to 50 Area Mail messages.
- You cannot receive Area Mail messages in the following cases*1:
 - During international roaming
 - During a call
 - In Flight mode
 - While the PIN code input screen, which appears after the power has been turned on, is displayed
 - When you are out of the service area
 - When the power is off
- You might not be able to receive Area Mail messages in the following cases*1*2:
 - During data communication
 - While updating software
 - During communication using a USB connection
 - When this mobile phone does not have much free memory left

*1 You cannot receive the message once you failed to receive it.

*2 Even when you could receive it, the contents are not automatically displayed.

Receiving Early Warning "Area Mail"

When an Area Mail message is received, you are notified of its receipt by a phone ringtone, warning tone and vibration which are unique to Area Mail. Its contents are displayed automatically.

- The volume level of the ringtone and warning tone and the vibrations are fixed and thus cannot be changed.
- When the mobile phone is purchased, the ringtone and warning tone are set to sound even in Silent mode. You can adjust the settings to ensure the tones will not sound (☞ P.155).

Reading Received Area Mail

1 Home screen ▶  ▶ [Area Mail]

Area Mail message list screen is displayed.

2 Tap an Area Mail to read

Setting Early Warning "Area Mail"

Set whether to receive an Area Mail message, also set the performance when you receive it.

1 Area Mail message list screen ▶  ▶ [Settings] ▶ Perform operations listed below:

Area Mail enabled	Set whether to use Area Mail.
Silent mode settings	Set whether the ringtone and warning tone are to sound in Silent mode when an Area Mail message has been received.
Ring time	Set the duration for which the ringtone and warning tone are to sound.
Check ring tone	You can check the operations performed when "Earthquake Early Warnings" or "disaster/evacuation information" has been received.
Message ID Registration	Register the Area Mails to be received in addition to Earthquake Early Warnings or disaster/evacuation information.

Google Talk

Google Talk is Google's online instant messaging service. You can enjoy chatting with other members using Talk application on this mobile phone.

- Set your Google account (📧 P.83) in advance.

Online Chat

Adding a New Member

1 Home screen ▶  ▶ [Talk]

Friends list is displayed.

2 Friends list ▶  ▶ [Add friend]

3 Enter Google account of the member to add ▶
[Send invitation]

Accepting Invitation

1 Friends list ▶ [Chat invitation] ▶ [Accept]

Setting Online Status

1 Friends list ▶ Tap your own account

2 Tap the status field

3 Tap an online status to set

- Enter a status message in [Status message] field as necessary. The status message you entered will be displayed as a custom message when you select an online status next.

4 [Done]

Starting Chat

1 Friends list ▶ Tap the name of a friend to chat with

Chat screen is displayed.

2 Enter message in [Type to compose] field

- To enter a smiley, press  ▶ [More] ▶ [Insert smiley] ▶ select a smiley.

3 [Send]

Switching Chats

You can switch chats when you are chatting with more than one friend.

1 Chat screen ▶  ▶ [Switch chats]

2 Tap a friend to chat with

Setting Chats Off Record

- Chat messages are saved in [Chats] label folder in Gmail unless you set chats off record.

1 Chat screen ▶  ▶ [Chat off record]

Subsequent messages will be off record.

Ending Chat

1 Chat screen ▶  ▶ [End chat]

Managing Members

Members on the friends list are displayed by online status (Available, Busy, Invisible).

Depending on the setting, only the members that you frequently exchange Emails with or chat with are preferentially shown. To display all listed members, press

 ► [All friends] in the friends list.

1 Friends list ► Touch and hold the name of a member to block

- You can view member information and block the member.

Setting Google Talk Options

1 Friends list ► ► [Settings]

- You can configure settings regarding automatic sign-in when you turn on the mobile phone, notification, etc.

Signing Out

1 Friends list ► ► [Sign out]

Web Browser

Using the web browser, you can view web pages and play Flash contents as you do with a PC.

Connection to a Wi-Fi network or wireless mobile network using packet communication is necessary to use the web browser on this mobile phone.



Starting Web Browser

1 Home screen [Browser]

Home page is displayed.







2 Enter URL or keyword in the address bar

- If the address bar is not shown, drag the web page down or press .
- You can start Voice Search by tapping the address bar and .

3 Tap or select the web page you want to view from the suggestion list

Screen Operations When Web Page Is Displayed

Operation		Description
Switch Vertical/horizontal display modes		 P.47
Zoom in/out	Pinch out/in	 P.47
	Double-tap	 P.46
Scroll		 P.47
Select and copy text		Touch and hold a part with no link ► Drag the slider in four directions to select text range to copy ► Tap selected text



Web Page Link Operations

- 1 Web page displayed ► Touch and hold a link ► Perform operations listed below:**

Open	Open the web page.
Open in new window	Open the web page in a new window.
Bookmark link	Add the URL to Bookmarks.
Save link	Save the web page to the mobile phone/microSD card.
Share link	Send the URL via Bluetooth communication or by mail.
Copy link URL	Copy the URL.
Save image	Save the image to the mobile phone/microSD card.
View image	View the image.
Set as wallpaper	Set the image as home screen wallpaper.

Menu for Currently Displayed Web Page

1 Web page displayed ►  ► Perform operations listed below:

New window		Open the web page in a new window.
Bookmarks		Display the bookmark list.
Windows		Display the window list to switch web pages.
Refresh/Stop		Refresh or stop refreshing the web page.
Forward		Return to the previous page when the web page is displayed by pressing  .
More	Add bookmark	Add the URL to Bookmarks.
	Find on page	Search for text in the web page.
	Page info	Display the web page URL.
	Share page	Send the web page URL via Bluetooth communication or by mail.
	Downloads	Display files downloaded from websites (applications obtained from websites other than Android Market, images, documents, etc.). <ul style="list-style-type: none"> You can also display downloaded files by displaying the home screen ►  ► [Downloads].
	Settings	You can configure settings regarding web page display, privacy, security, etc.

Managing Bookmarks and History

Adding a Bookmark

1 Display the web page you want to add to Bookmarks ►  ► [Bookmarks] ►  ► [Bookmark last-viewed page]

2 Confirm/change the bookmark name ► [OK]

Editing a Bookmark

1 Web page displayed ►  ► [Bookmarks] ► Touch and hold a bookmark to edit ► [Edit bookmark]

2 Enter change ► [OK]

Deleting Bookmarks

1 Web page displayed ►  ► [Bookmarks]

2 **To delete a bookmark**
Touch and hold a bookmark to delete ► [Delete bookmark]

To delete all bookmarks

 ► [Delete all]

3 [OK]

Displaying a Web Page from History

1 Web page displayed ►  ► [Bookmarks] ► [Most visited] tab/[History] tab

- Tap  (gray) in History to add to Bookmarks.

2 Tap a web page to display

Clearing History

1 Web page displayed ►  ► [Bookmarks] ► [History] tab

2 To delete a web page from history

Touch and hold a web page to delete ► [Remove from history]

To delete all web pages from history

 ► [Clear history]

- Clearing history will also delete all web pages from [Most visited] tab.

File Management

Infrared Communication

This mobile phone is compliant with IrMC™ version 1.1 standard. Data transmission with other mobile phones, etc. that have infrared communication feature is possible.

- Data of phonebook, images, Fit Key and Odekake features in Future Plus can be sent/received.
- Depending on the application, even when you select a menu for sharing data via infrared communication, the data may not be sent, or received data may be unavailable.
- If the receiving terminal has an image that has the same file name with the image to be sent, the file of the receiving terminal may be overwritten when the image is sent.
- Keep the infrared port faced to that of the other party until data communication is completed.
- If you hold the mobile phone by hand, stabilize it securely.
- Communication may not be established normally in places exposed to direct sunlight, immediately below fluorescent lamp or near any infrared device.

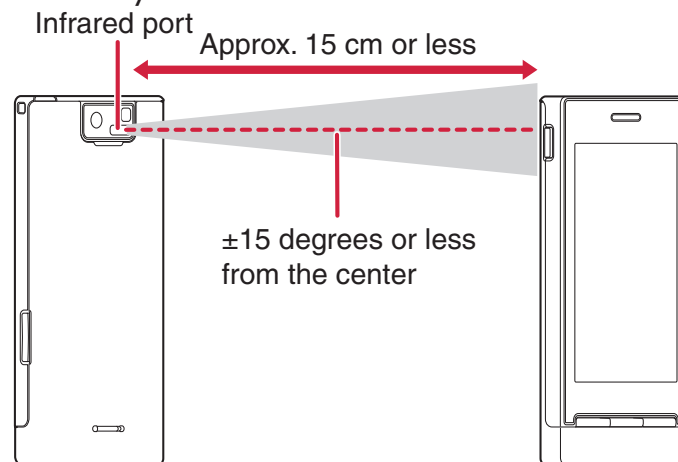

Sending Data via Infrared Communication

1 Start each application ▶ Select data to send ▶
 ▶ Tap the menu item for sending/
sharing via infrared communication

- To send a package of Fit Key, display the home screen ▶  ▶ [Fit Key] ▶ [パッケージ (Package)] ▶ select a package ▶ [赤外線送信 (Send via IrDA)].

2 [Send] ▶ After sending, [OK]

- To send all contacts via infrared communications,  P.103
- Group names are not sent when sending contacts one by one.

Receiving Data via Infrared Communication

1 Home screen ▶ ▶ [Infrared]

- To receive a package of Fit Key, display the home screen ▶  ▶ [Fit Key] ▶ [パッケージ (Package)] ▶ [赤外線受信(Receive via IrDA)].

2 To receive a subject

[Receive] ▶ [Receive] ▶ After receiving, [Yes] ▶ [OK]

To receive all subjects

[Receive All] ▶ Enter 4-digit password ▶ [OK] ▶ [Receive] ▶ After receiving, [Yes] ▶ [OK]

- To receive all subjects via infrared communication, the same 4-digit password has to be entered on the sending terminal.
- When a subject is being sent from the sending terminal, select [Receive]. If you select [Receive All], you cannot save the received data.
- To add the received contacts to the phonebook, tap [Add] after receiving ▶ [OK].
- To overwrite your phonebook with the received contacts, tap [Over write] after receiving ▶ [Yes] ▶ [OK].
- The received contacts are saved to the docomo account phonebook.

Bluetooth Communication

You can wirelessly exchange data with nearby Bluetooth devices using the Bluetooth function of this mobile phone.

- For Bluetooth supported version and profiles,  P.263
- For detailed information of settings and operation procedures, also refer to the Instruction Manual for the Bluetooth device to be connected.
- Any statement in this manual shall not be construed as warranty for wireless connection with other Bluetooth devices.

Precautions for Handling Bluetooth Devices

■ Note the following points to ensure good connection:

- Ensure about 10 m of line-of-sight distance from the other Bluetooth device. Connectable range may be narrower depending on surrounding environment (walls and furniture, etc.) and building structure, or if there is any obstacle between this mobile phone and Bluetooth device to be connected. They may not be connected if they are in different floors or rooms divided by ferroconcrete walls. No warranty is given as to the connection distance stated above.
- Use Bluetooth devices away from other devices (electric/AV/OA equipment) as possible. (As the devices are easily affected by microwave in use, so keep your devices away from any microwave.) Otherwise, improper connection, TV or radio noise and reception fault may be caused. (TV picture is distorted for certain channels of UHF and satellite broadcasting.)
- When devices are not connected properly due to any broadcasting station or radio transmitter near you, relocate the counterpart Bluetooth device. Connection may fail if the device is surrounded by strong radio wave.
- Wireless connection is possible with Bluetooth device put in any bag or pocket. However, decreased transmission speed or noise may result when your body is in between Bluetooth device and this mobile phone.

■ Radio wave interference with wireless LAN

As Bluetooth and wireless LAN (IEEE802.11b/g/n) use the same frequency band (2.4 GHz), use of Bluetooth device around wireless LAN device may cause radio wave interference, leading to decreased communication speed, noise or connection failure.

In this case, take actions below:

- Make sure to keep this mobile phone and Bluetooth device to be connected 10 m away from wireless LAN device.
- Otherwise, turn off wireless LAN device.

■ Radio wave transmitted from Bluetooth device may affect operations of medical electronics.

As this may cause an accident in some instances, be sure to turn off your mobile phone and Bluetooth device(s) in the following locations:

- In train
- In aircraft
- In hospital
- Near auto door or fire alarm
- Any place where flammable gases may be present (e.g. gas station)

Connecting a Bluetooth Device

You can exchange data with Bluetooth-compliant PCs, mobile phones, etc. via Bluetooth communication.

Furthermore, you can connect a Bluetooth headset to make a call or listen to music in hands-free mode.

- Be sure to turn on the Bluetooth function of the device to be connected and check it is connectable in advance.

1 Home screen ►  ► [Setting] ► [Wireless & networks] ► Mark [Bluetooth] checkbox ► [Bluetooth settings]

Bluetooth settings screen is displayed.

2 [Scan for devices]

- Detected Bluetooth devices are listed in the Bluetooth device list.
- Mark [Discoverable] checkbox to allow other Bluetooth devices to detect this mobile phone for about 120 seconds.

3 Select a detected Bluetooth device and perform pairing with the device

4 If necessary, enter pass code (PIN) ► [OK]

- If the other Bluetooth device also requires pass code (PIN), enter corresponding pass code (PIN).
- When pairing is established, status description such as [Paired but not connected] and [Connected to phone and media audio] appears below the device name.

Information

- If you do not use Bluetooth communication, turn off the Bluetooth function to save energy consumption.
- Bluetooth on/off setting remains unchanged after the power is turned off.
- The Bluetooth function is turned off when Portable Wi-Fi hotspot is enabled (☞ P.118).

Changing Device Name

You can change the name of your mobile phone displayed on the other device during Bluetooth communication.

- 1** Bluetooth settings screen ► [Device name] ► Enter name ► [OK]

Sending and Receiving Data via Bluetooth Communication

- Depending on the application, even when you select a menu for sharing data via Bluetooth communication, the data may not be sent, or received data may be unavailable.

Sending Data via Bluetooth Communication

You can send images, web page URLs, etc. to other Bluetooth devices.

- Do this from the sending/sharing menu of each application.

Receiving Data via Bluetooth Communication

1 Send data from the sending device

 appears in the status bar to notify of incoming data.

2 Open notification panel ► [Bluetooth share: Incoming file] ► [Accept]

- When  appears in the status bar, open the notification panel to check that reception is completed.

Disconnecting a Bluetooth Device

1 Bluetooth settings screen ► Touch and hold a device to unpair from the Bluetooth device list ► [Unpair]/[Disconnect & unpair]

- If [Disconnect] appears in the menu, the device can be disconnected temporarily by tapping it. Temporary disconnection can also be done by tapping the device in the Bluetooth device list.

VPN (Virtual Private Network) Connection

VPN (Virtual Private Network) refers to a technology that allows for access to information within a protected local network for a company, university or the like from outside. To configure settings for VPN connection from this mobile phone, acquire security information from network administrator.

Adding VPN

1 Home screen ▶  ▶ [Setting] ▶ [Wireless & networks] ▶ [VPN settings]

VPN settings screen is displayed.

2 [Add VPN] ▶ Tap a type of VPN to add

- If ISP has been set to spモード(sp-mode), PPTP is not available.

3 Set each item by following instructions of network administrator ▶  ▶ [Save]

New VPN is added to the list in the VPN settings screen.

Connecting to VPN

1 VPN settings screen ▶ Tap a VPN to connect

2 Enter necessary credentials ▶ [Connect]

Once the VPN is connected, a notification icon is displayed in the status bar.

Disconnecting VPN

- 1** Open the notification panel ▶ Tap the notification that indicates connection with VPN to disconnect

Once the VPN is disconnected, the notification icon in the status bar is grayed out.

External Device Connection

Connecting to a PC

When you connect this mobile phone and a PC using the included microUSB cable, the microSD card in the mobile phone is recognized as a removable disc of the PC, and you can read and write data in the microSD card from the PC.

- If any application that uses microSD card is running in the mobile phone, close the application and mount the microSD card to the PC.

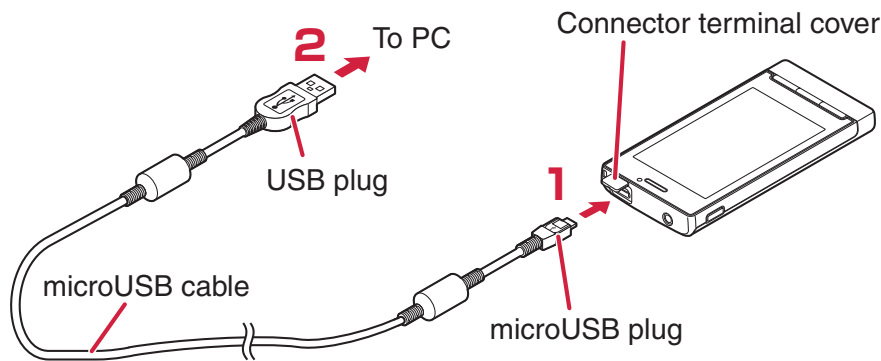

1 Insert the microUSB plug of the microUSB cable horizontally into the connector terminal with the USB mark (↔) facing up

- Place the connector terminal cover as indicated in the figure. For information on how to open the connector terminal cover,  P.42

2 Insert USB plug of the microUSB cable horizontally into the USB connector of the PC

USB Mass Storage screen is displayed.

- If the USB Mass Storage screen is closed, open the notification panel and tap the notification to display the screen.

3 [Turn on USB storage]

- If [Turn on USB storage] is displayed, tap [OK]. Terminate the application that uses microSD card if required.

4 PC side ▶ Open [My Computer]/[Computer] ▶ Select [Removable disc]

Files in the microSD card are displayed.

5 Drag and drop files between the mobile phone and PC

Information

- Once microSD card is mounted on the PC, you cannot use any application that uses microSD card such as camera.

Securely Removing microUSB Cable

- Do not remove microUSB cable while data is being transferred. Otherwise data may be corrupted.

1 USB Mass Storage screen ▶ [Turn off USB storage]

2 Remove microUSB cable

Applications

Camera

Precautions for Use

- Ensure the lens is clean before shooting. If it is not, clean up with soft cloth. Any dirt on the lens such as fingerprint or oil content may cause defocusing or dots in still images and videos.
- When shooting, take care not to cover the lens with your fingers or hair.
- When shooting, stabilize the mobile phone securely. Jiggling may cause defocus. Be careful not to jiggle especially in a poor light.
- Do not leave the lens in direct sunlight. Otherwise, discoloration and seizing of elements may occur.
- Shooting under illumination flickering at high frequencies - fluorescent lamp, mercury lamp and sodium lamp etc. - may cause "flicker phenomenon" that striped pattern is displayed as flowing up/down or right/left in a picture. Further, coloration may be odd depending on shooting timing.
- When in images of any object containing extremely bright part such as a part reflecting sunlight, black spots may be displayed on the bright part. This is no fault.
- Colors and brightness of images taken by the camera may be different from actual objects.
- When the battery power is low, new still image or video may not be saved normally.
- There is certain time lag between tapping the shutter button and shooting. Therefore, in still images, fast moving object may not be the place where it was when the shutter button is tapped.
- If the battery pack is removed while saving data to microSD card, the data will be incomplete.
- If you make any misconduct that creates a public nuisance by using this device, you are punishable under laws or ordinances (e.g. ordinance against disturbing the peace).



Please be considerate of the privacy of individuals around you when shooting and sending photos using camera-equipped mobile phones.

Displaying Shooting Screen

You can shoot images in either portrait or landscape format.

1 Home screen ► ► [Camera]

Still image shooting screen is displayed.



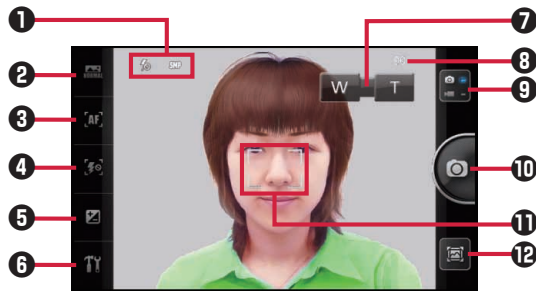

- To switch to the video shooting screen, tap .

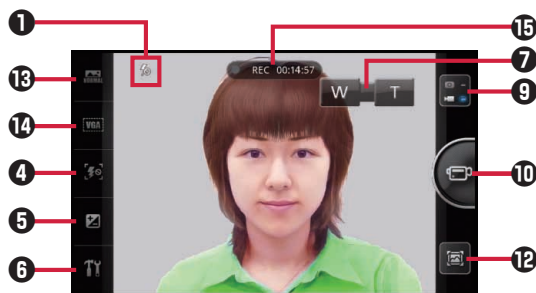

Still image shooting screen













Video shooting screen

- 1 Icons indicating setting status  P.177
- 2 Setting still image shooting mode  P.177
- 3 Setting focus mode  P.178
- 4 Set flash mode
- 5 Adjust exposure (brightness)
- 6 Setting from the setting panel  P.178
- 7 Display zoom bar (not displayed when the photo resolution is 5M)
- 8 Number of still images that can be shot
- 9 Still image/video shooting switching button
- 10 Shutter button
- 11 Focus frame
- 12 Display review screen
- 13 Set scene mode

14 Set resolution mode

15 Recording time

■ Icons indicating setting status

Item	Icon
Flash Mode	 Flash Torch,  Flash Off
Self Timer	 3 seconds,  5 seconds,  10 seconds
Photo Resolution	 5M,  3M,  2M,  WVGA,  VGA
Scene	 Night

■ Setting still image shooting mode

1 Still image shooting screen ► Tap  icon ►
Perform operations listed below:

Normal Shot	Normal shooting mode
Panorama	Shoot and couple multiple still images. Tap the shutter button and move the camera horizontally and vertically so that the white frame comes to the center of the green frame.
Smile Shot	Smile is detected and shot.
Burst Shot	While the shutter button is being touched, up to seven still images are shot in succession.
Contact ID	Shoot a face photo to add to the phonebook.
Frame Shot	Shoot an image with a preferred frame.
Collage Shot	Fit multiple photos in a preferred template.
Soft Focus	Obscure the background of person(s).
Beauty	Make the facial color beautiful in photos you shoot.
Stabilization Shot	Shooting is performed when jiggling stops.
Pinhole	Shade four edges.

■ Setting focus mode

1 Still image shooting screen ▶ Tap  icon ▶
Perform operations listed below:

Auto	Tap the shutter button to set focus in the focus frame.
Macro	Focus on a close object.
Infinity	Focus on distant landscape.

■ Setting from the setting panel

1 Still image/video shooting screen ▶  ▶
Perform operations listed below:

- In the setting panel, scroll the menu by dragging up/down.

Scene*1	Select the shooting mode according to the images which are to be shot, and shoot the images.
Effect	Shoot an image with optional effects such as monochrome and sepia.
Self Timer*1	Set the time length to automatic shutter release.
Photo Resolution*1	Set photo size (resolution).
Photo Quality/ Video Quality	Set quality.
White Balance	Correct color in accordance with surrounding light source.
Red Eye Remove*1	Turn red eye remove function on/off.
Delighting*1	Turn on/off the function to brighten any dark part.
GPS Location*1	Set whether or not to attach the location information.
Show Grid*1	Set whether to display/hide grid lines.
Audio Record*2	Set whether or not to record sound.

Review	Set whether to display/hide review screen after shooting.
Shot Mode*2	Set whether or not to shoot a video to attach to mail.
Reset	Restore the default shooting settings.

*1 Still image shooting only

*2 Video shooting only

Shooting a Still Image

Follow the procedure below when the shooting mode is “Normal Shot” and the focus mode is “Auto”.

1 Still image shooting screen ▶

When the image is shot, the shutter sound tripping is generated after focusing.

The shot still image is stored in microSD card.

If [Review] is on, the review screen appears.

Shooting a Video

1 Video shooting screen ▶









The recording start sound is generated and video shooting starts.

2

Recording end sound is generated and the shot video is stored in microSD card.

If [Review] is on, the review screen appears.

Review Screen Icons

Icon	Description
	You can upload the file to Facebook or YouTube, or send the file via Bluetooth communication or by Gmail, etc.
	Switch to the previous/next file.
	Display picture/video information.
	Return to the shooting screen.
 *1	Save (set) the shot still image.
	Play the video.
	Delete the file.
 *1	Discard the shot still image and shoot again.

*1 In case you have activated the camera from New contact/
Edit contact screen or other functions.

Gallery

You can use Gallery to view still images and videos saved in microSD card.

■ Supported files

Type	File format
Still image	JPEG, GIF, PNG, BMP
Video	H263, H264, MPEG-4, VC-1, Divx

Displaying a Still Image/Video

1 Home screen ► ► [Gallery]

Album list screen is displayed.

- You can activate the camera by tapping  on the album list screen.

2 Tap an album to display



File list screen is displayed.

- Switch the list display (an order of the date) and date display by tapping  on the file list screen.

3 To display a still image

Tap a still image to display

Enlarged view screen is displayed.

- Reduce or enlarge the size of the images by tapping / , by pinching out/in or by double-tapping.
- Tap [Slideshow] to start slideshow.
- Tap [Menu] to display a menu ( P.182).
- If icons are not displayed, tap the screen to show them.

To play a video

Tap a video to play

Start playing the video.

- By tapping the icon displayed on the screen, the video can be paused/played, rewound or forwarded. If the icons and progress bar showing the playback time are not displayed, they will be displayed when the screen is tapped.

Menu While Gallery is Activated

1 While Gallery is activated ► ► Perform operations listed below:

- The menu can also be displayed by selecting the data to be manipulated, and by touching and holding it.

Share		You can upload the file to Facebook or YouTube, or send the file via Bluetooth communication or by Gmail, etc.
Delete		Delete the file.
More	Details	Display file information.
	Set as^{*1}	Set an image as phonebook image or home screen wallpaper.
	Crop^{*1}	Trim a still image.
	Rotate Left^{*1}	Rotate a still image 90 degrees counterclockwise.
	Rotate Right^{*1}	Rotate a still image 90 degrees clockwise.

*1 Still image only

Music Player

Start the music player to play songs stored in microSD card.

- For copying music data from PC,  P.173

■ Supported files

Some songs may not be playable even though they are supported files.

File format (extension)
3gp, mp4, m4a, mp3, mid, xmf, mxmf, rtttl, rtx, ota, imy, ogg, wav

Playing Songs

1 Home screen [Music]

Library screen is displayed.

- Tap [Artists]/[Albums]/[Songs]/[Playlists] to switch tabs.

2 Select an artist, album or playlist

Song list screen is displayed.

3 Tap a song to play

Playback screen is displayed and playback is started.



: Display the song list screen.



: Tap to enable/disable shuffle feature.



: Tap each time to repeat all songs → repeat current song → cancel repeat.



: Skip to the start of song/next song. Touch and hold to rewind/forward.



: Pause/play.

- To return to the library screen, press  ► [Library].
- Touch and hold the artist name/album name/song name in the playback screen ► [Browser]/[Music]/[YouTube] to search for associated information.
- To return to the playback screen from the other applications, open the notification panel and tap the notification.

Playing with Party Shuffle

1 Playback screen ► ► [Party shuffle]

A playlist that consists of songs randomly extracted from all songs in the library is created and playback starts.

2 To abort party shuffle,

Setting Present Song as Ringtone

1 Playback screen ► ► [Use as ringtone]

Creating a Playlist

1 Song list screen ► Touch and hold a song to add to a new playlist ► [Add to playlist] ► [New] ► Enter playlist name ► [Save]

- To add a song to a playlist, display the song list screen ► touch and hold a song to add ► [Add to playlist] ► tap the destination playlist.

Editing Songs in a Playlist

1 Library screen ► [Playlists] ► Tap a playlist to edit

2 To sort the song list

Drag  to sort

To dismiss a song

Touch and hold a song to dismiss ► [Remove from playlist]

Changing Playlist Name/Deleting a Playlist

1 Library screen ► [Playlists] ► Touch and hold a playlist which you want to rename/delete ► [Rename]/[Delete]

- If you select [Rename], enter new playlist name and tap [Save].
- [Recently added] playlist cannot be renamed or deleted.

Android Market

Search for convenient applications and fun games in Android Market to install to this mobile phone.

- Set your Google account (👉 P.83) in advance.

Installing Applications

1 Home screen ▶ ▶ [Market]

- Read Android Market Terms of Service for initial startup and tap [Accept].

2 Search for applications

3 Tap an application to install

4 [FREE] (for free applications) or tap the price field (for pay applications) ▶ [OK]

- Take special care when you install an application that accesses to many functions or massive data. Tapping [OK] means you accept responsibilities for consequences of use of the application.
- Use Google Checkout for payment for pay applications. You are allowed to return the application to get a refund in the specified time period from application download (only once per application). For detailed information on payment method for purchase of applications and refund policy, press  in the market screen ▶ [Help].

Information

- Be sure to check the security and safety of the application, then install it at your own risk. Your mobile phone may be infected with a virus or data may be damaged. It may cause excessive sound volume.
- We take no responsibility for any malfunction arising out of applications you install.
- We take no responsibility for any disadvantage for you or third party arising out of applications you install.
- Some applications automatically perform packet communication for Internet connection. Note that packet communication fee may be expensive.
- We provide no assistance for purchase of applications from Android Market or refund.

Using docomo market

You can easily access websites recommended by DOCOMO and useful applications from docomo market.

1 Home screen ► ► [docomo market]

The browser is launched and “docomo market” is displayed.

Information

- Internet connection via packet communication (3G/GPRS) or Wi-Fi is required for use of the docomo market.
- Connection to the docomo market and downloading applications introduced in the docomo market will charge packet communication fee separately. Note some applications automatically perform packet communication.
- Some applications introduced in the docomo market may be pay applications.
- We at DOCOMO take no responsibility for any losses arising out of sites introduced in the docomo market or information obtained from the sites.
- We at DOCOMO take no responsibility regarding to operations, suitability for certain usage and reliability of applications introduced in the docomo market.
- Some applications may pose problems: unstable operations of your mobile phone and unauthorized distribution and use of your location information and personal information stored in the mobile phone. Therefore, you need to thoroughly check the source and behaviors of intended applications before use.
- Copyrighted works (text, photo, illustration, video, sound and software, etc.) presented on this site are properties of DOCOMO or other third parties, and protected by the copyright laws and associated law and conventions. You have no right to copy, adapt or distribute the copyrighted works without permission from the copyright holder except for when the copy or quote is for personal use that is allowed by the copyright law.

Future Plus

Once you have started Future Plus, you can check updates in Twitter, mixi and Facebook, call log, new messages (SMS), sp-mode mails, recently played songs, recently shot photos, etc. from the same screen. Furthermore, you can automatically obtain desired information from web services, and view tweets that are found by automatic search of Twitter.

Configuring Initial Setting

When you launch Future Plus for the first time, you must set your user name, character, date of birth and wallpaper.

1 Home screen ▶  ▶ [Future Plus]

2 [設定する (Start initial setting)] ▶ Follow on-screen instructions

Your character is created and the mainline screen appears.

- Each item in the initial setting can be changed individually later (☞ P.191).

Displaying Mainline Screen

1 Home screen ▶  ▶ [Future Plus]



Mainline screen

1 Mainline (panels)

Flick right or left to switch to individual function line.

2 Odekake start button

- ③ User name, character and point display
- ④ Changes to the gleaming icon when you enlarge the panel by tapping it.
- ⑤ Jump to unread button
Tap to place unread message (SMS), sp-mode mail or missed call panel at the center.
- ⑥ Refresh button
Refresh the Twitter, mixi and Facebook panels.
- ⑦ Function icon
A function line of the tapped icon is displayed.

■ About mainline/function line panels

- Up to 50 panels per line are displayed with new panels added to the top of the line.
- To show hidden panels, flick the panels clockwise/counterclockwise.
- Tapping a panel will move the panel to the center and enlarge it.
- Double-tapping the panel or tapping the gleaming icon in the enlarged panel will show associated application screen (detailed message screen, call screen or web service information screen, etc.).
- Dragging the enlarged panel will show  (Trash can). Drag the panel into the trash can to delete it.
- As for outgoing Twitter, mixi and Facebook panels, only the latest panel is displayed on the mainline.
- Tap the image area in the enlarged panel of call log, message (SMS) or sp-mode mail to add a contact to the phonebook or see details of the contact.
- In the enlarged panel for Twitter reception, following operation buttons are displayed:
 - [Re]: Shows reply entry screen
 - [QT]: Shows quoted tweet entry screen
 - [RT]: Shows retweet entry screen
 - [DM]: Shows direct message entry screen
- Double-tapping a search log panel of Twitter in the mainline will show the search result line again.

Future Plus Setting Menu

1 Mainline/function line screen ►  ► [設定 (Settings)] ► Perform operations listed below:

ユーザ名 (User name)	Set your user name.
キャラクター (Character)	Select a character. Characters in [SECRET] are disclosed depending on the amount of used points. <ul style="list-style-type: none"> Character decoration is canceled when you change character.
誕生日 (Date of birth)	Register your date of birth.
壁紙 (Wallpapers)	Select a screen theme.
使いたい機能 (Desired functions)	Select functions you want to use in Future Plus.
知りたい情報 (Desired information)	Select information you want to know in Future Plus.
自己紹介メッセージ (Self-introduction message)	Register a message that is shown when you visit other mobile phones.
おまかせ検索 (Omakase Search)	To use Omakase Search, mark [有効にする (Enable)] checkbox.
電車案内設定 (Train service information setting)	Define your life style in [簡易設定 (Simple settings)]. To obtain more accurate information, configure [詳細設定 (Advanced settings)].
Twitter	Set Twitter, Facebook and/or mixi accounts and refresh interval. <ul style="list-style-type: none"> Your accounts will not refresh during Sleep mode. After Sleep mode has been released, if it is taking a long time refresh, please refresh manually.
Facebook	
mixi	

Information

- Contents of the services and information are offered by their respective providers. Due to any reason of the providers, the contents of the services and information may change or no longer delivered in the future without notice.

About Desired Information

Information applicable to present location and time are automatically obtained from web services and displayed in the mainline. Information selected in the desired information setting will be displayed.

Desired information	Description
天気予報 (Weather forecast)	Weather forecast for the area you are currently in.
占い (Fortune)	Horoscope and today's fortune.
ニュース (News)	Up to three latest news.
ぐるなび (Gurunavi)	Up to three restaurants near your current position.
電車時刻表 (Train time table)	Transit and train information from your nearest station to frequently-visited stations.
終電案内 (Last train Notice)	Notice of last train from frequently-visited station to your nearest station, which is displayed after 10:00 PM on weekdays.

Information

- To obtain and display information well suited to your lifestyle, you need to enter correct information in each field of the date of birth and train service information setting, in addition to selecting items in the desired information setting.
- Depending on the radio wave condition of 3G network and/or GPS, desired information may not be displayed.

Using Surrounding Search

The names of landmarks near the present location are automatically set as a keyword for Tweet search in Twitter.

- Set your own Twitter account and select [Twitter] in the desired function setting in advance.

1 Mainline screen ▶ ▶

Surrounding search result line appears.

- If results of landmark name search are scarce, tweets near the present location are automatically searched for and displayed.

Using Omakase Search

Words frequently used are automatically set as a keyword for Tweet search in Twitter.

- Set your own Twitter account in advance. And select [Twitter] in the desired function setting, and mark [有効にする (Enable)] checkbox in the Omakase Search setting.
- The UnitSearch API provided by Yahoo! JAPAN is utilized for Omakase Search.

Web services by Yahoo! JAPAN

<http://developer.yahoo.co.jp/webapi/search/assistsearch/v1/webunitsearch.html> (in Japanese only)

1 Mainline screen ▶ [おまかせ検索はここをタッチ (Touch here for Omakase Search)] ▶ [はい (Yes)]

Omakase Search result line appears.

- [おまかせ検索はここをタッチ (Touch here for Omakase Search)] is automatically displayed sometime after you have repeatedly entered a certain word that is usable as keyword for Twitter search using Fit Key.

2 [戻る (Back)]

3 When [よろこんでいただけましたか? (Satisfied?)] appears, [はい (Yes)]/[いいえ (No)]

Obtained points are shown.

Using Odekake Function

Use infrared communication to exchange with other mobile phones.

1 Mainline screen ▶ Tap Odekake start button ▶ Perform operations listed below:

でかける (Visit)	Your character visits the counterpart mobile phone. <ul style="list-style-type: none">• To allow Odekake Search to be performed at the visiting mobile phone, mark [有効にする (Enable)] checkbox in the Omakase Search setting.
むかえる (Welcome)	Receive the counterpart character to your mobile phone and the counterpart's self-introduction message is displayed. In addition, Odekake Search can be performed by setting a word frequently entered by the counterpart as keyword. <ul style="list-style-type: none">• To perform Odekake Search, set your own Twitter account and select [Twitter] in the desired function setting in advance.

Information

- Infrared communication will fail if Odekake function of Future Plus is not activated in the counterpart mobile phone.

Using Shop Function

You will get points according to how you use Future Plus. You can purchase decoration items of your choice with earned points, and decorate your character screen.

Purchasing Items

- 1** Mainline screen ▶ Tap the point display
- 2** Select items to purchase ▶ [購入 (Purchase)] ▶ [はい (Yes)]
- 3** When the items are stored in the closet, [OK]
- 4** [はい (Yes)]/[いいえ (No)]
 - Tap [はい (Yes)] to decorate the screen now (👉 step 3 to 4 in P.196 "Decorating Screen with Purchased Items").

Decorating Screen with Purchased Items

- 1** Mainline screen ▶ Tap the point display ▶ [クローゼット (Closet)]
- 2** Select items to use ▶ [デコる (Decorate)]
- 3** When the item is 空デコ (sky deco)
Drag the item in four directions to define the position
When the item is 丘デコ (hill deco)
Drag the item right or left to define the position
When the item is キャラデコ (character deco)
Tap the character to enter character-deco edit mode ▶ Drag the item in four directions to define the position ▶ [OK]
To delete an item from the screen (return to the closet)
Touch and hold an item, and drag it to 
 - To delete a character deco, enter the character-deco edit mode in advance.
- 4** [OK] ▶ [はい (Yes)] ▶ [OK]

Google Maps



Using Google Maps, you can locate your current position, and search for places or routes to destinations.

- To use Google Maps, the mobile phone must be connected to a Wi-Fi network or 3G/GPRS network to enable data communication.
- Enable location detection in wireless networks and GPS function in the Location & security settings (👉 P.125).
- Google Maps does not cover all countries and regions.

Opening Google Maps

1 Home screen ▶  ▶ [Maps]

A map is displayed.

- When [Improve My Location] is displayed, tap [Settings] and enable location detection in wireless networks and GPS function (👉 P.125).
- Search by entering a keyword in the search box at the top of the screen, and red circles or a balloon will appear on the map. Tap a red circle to show a balloon. Tap a balloon to show detailed information and options.
- Tap  to show a flashing blue arrow indicating the current location on the map.
- Tap  to start Places and search for nearby restaurants, attractions, ATMs, gas stations, etc. Note that filtering results by distance, rating or open hours may not work correctly.
- Tap  to select and display layers for traffic conditions and satellite photo, etc. However, traffic conditions and transit lines are available in limited areas.
- You can tilt the map by sliding two fingers up and down as if drawing parallel lines on the screen.

Searching for a Route to Destination

1 Map displayed ► ► [Directions]

- You can start Google Maps Navigation (Beta version) by displaying the home screen ►  ► [Navigation] to search for a route from your current location to any destination without efforts.

2 Enter start and end points

- Tap  to specify a contact or point on the map.

3 (Automobile)/ (Public transportation)/ (Walk) ► [Get directions]

Checking Friend's Location Using Latitude

- Set your Google account in advance ( P.83).
- To share locations with friends, you need to join Latitude and invite friends or accept invitations from friends.

1 Map displayed ► ► [Join Latitude]/ [Latitude]

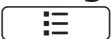
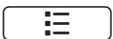
- When you use Latitude for the first time, you need to read and agree with Google Privacy Policy.
- You can also start Latitude by displaying the home screen ►  ► [Latitude].
- For detailed information on Latitude, refer to the Latitude help which can be displayed by performing the following procedure:
Latitude screen ►  ► [See map] ► 
► [More] ► [Help] ► [Latitude]

1Seg

1Seg is terrestrial digital TV broadcasting service dedicated for mobile devices. With 1Seg, you can watch data broadcast along with video and audio. Further, detailed program information, participation in quiz show, etc. and TV shopping are readily available.

For details on the 1Seg service, browse the following website:

**The Association for Promotion of Digital Broadcasting:
<http://www.dpa.or.jp/>**

■ Using 1Seg

- 1Seg is a service provided by television entrepreneurs (broadcasting stations). You are not charged a communication fee for receiving video and audio. For about fee charged by NHK, contact NHK.
- There are two types of information displayed in the data broadcast area: “data broadcast” and “data broadcasting site”. “Data broadcast” is transmitted via broadcasting waves along with video and audio. To view a “data broadcasting site” prepared by a TV broadcaster (station), you need to access the site from information contained in data broadcast. Packet communication fee is charged for viewing “data broadcasting sites”. Using some sites may also incur information fees.

■ Broadcasting waves

1Seg, one of the broadcasting services, is transmitted using a different radio wave (broadcasting wave) from that used for FOMA services. Therefore, 1Seg cannot be received in places where broadcasting wave cannot reach or during hours in which 1Seg broadcasting service is suspended, regardless of whether you are in the FOMA service area.

Furthermore, even in the terrestrial digital TV broadcasting service area, reception may be poor or impossible in such places as listed below:

- Places away from radio towers transmitting broadcasting waves
- Places where radio waves are interrupted by land features or buildings such as in mountains and beside a tall building

- Places where radio waves are weak or cannot reach such as in tunnels, underground malls and recesses inside a building
To improve reception, fully extend the 1Seg antenna. Reception may also be improved by changing the antenna direction or moving to a different place.

■ 1Seg antenna

To watch 1Seg, fully extend the 1Seg antenna.

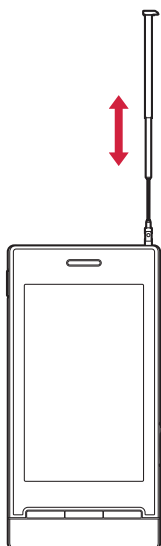

Pull out the tip of the 1Seg antenna and extend it until it stops

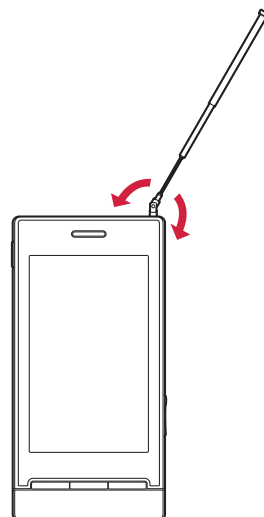

Change directions without forcible pressure

- When stowing the 1Seg antenna, do not stow it using excessive force. Otherwise, the antenna may be damaged. Push it straight back in until it stops, adjust its direction, and then fold it down and stow.
- When you do not watch 1Seg, stow the 1Seg antenna. Also stow the 1Seg antenna before making a call.

Starting 1Seg

1 Home screen ►  ► [1Seg]

1Seg watching screen is displayed.

- At the time of initial startup, you need to set a channel list corresponding to your region ( P.204).

1Seg Watching Screen

At the time of purchase, the screen is displayed in landscape mode, and video is displayed full-screen. Data broadcast is displayed in portrait mode.

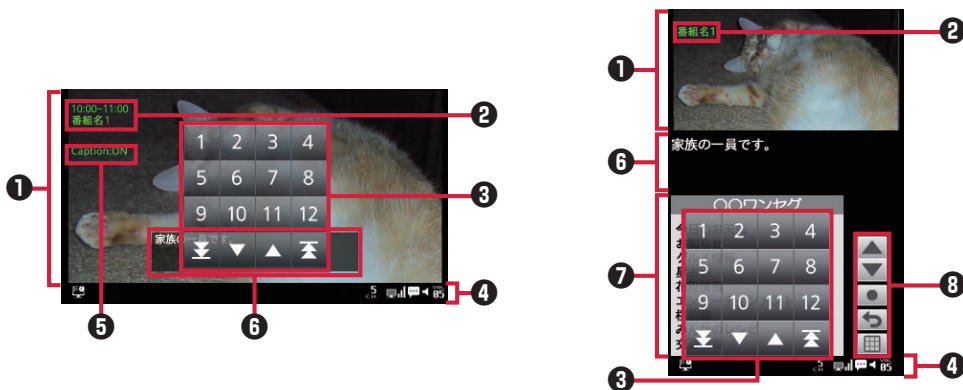

① Video area

② Program information*¹

③ Controller panel

Displayed by pressing ► [Controller]

: Direct channel selection *²

: Switch channels

: Search for available channels

④ Status display area*³

/ : Off timer/Auto off if no operation

: Channel number

: Reception level Strong/Medium/Weak/Out of service area

: Caption available

: Mute/Unmute

: Volume

⑤ Caption setting status*¹

⑥ Caption area

⑦ Data broadcast area

⑧ Data broadcast operation buttons:

: Move cursor

: Select/Return

: Show ten-key keypad

- *1 Displayed when portrait and landscape modes are switched. Also displayed when you tap the video area or caption area.
- *2 You can also select a channel by tapping the video area or caption area.
- *3 Displayed by tapping the screen when video is displayed full-screen in landscape mode.



1Seg Function Menu

1 1Seg watching screen ►  ► **Perform operations listed below:**

Controller	Display the controller panel.
Display switch	Switch display formats of the watching screen. <ul style="list-style-type: none"> • When you operate this menu item, the settings of [Switch display type], [Caption setting] and [Switch Port/Land] are also changed accordingly.
mute	Mute/unmute.
Settings	 P.202

1Seg Setting Menu

1 1Seg watching screen ►  ► **[Settings]** ► **Perform operations listed below:**

Channel info	Display the detail screen of the active channel list.
Display program info	Program name, channel name, start/end time and program description are displayed.
Select channel list	 P.205
Channel setting	 P.204
Add to channel list	Add the currently viewing channel to the active channel list.
Switch display type*1	Set whether to display data broadcast full-screen in portrait mode.

Caption setting*1	Turn caption display ON/OFF.
Switch Port/Land*1	Set the 1Seg watching screen to portrait or landscape mode.
Icon in landscape	Set whether to display icons in landscape mode. When this checkbox is unmarked, video is displayed full-screen.
Off timer	Display a confirmation screen after a specified time to end 1Seg watching. Off timer is not set if you select [OFF].
Brightness	When you unmark [Follows the setting of the system.] checkbox, you can set brightness applied only to the 1Seg watching screen.
Main/Sub sound	You can set Main/Sub/Main+Sub sound when viewing a program in which sub sound is available.
Switch audio data	Set Audio 1/Audio 2 for programs in which multiple audio tracks are available.
Volume	Set volume.
Sound effect	Turn sound effects of data broadcast ON/OFF.
Reset Confirmation dialog	Redisplay confirmation screens that have not been displayed since you marked [No need to confirm from next time] checkbox.
Back to data broadcasting	Return to data broadcast when accessing a communication contents site linked from the data broadcast.
Tune services	Select a service to watch when more than one service (program) is broadcasted from the same channel.
TVlink	 P.206
Auto off if no operation	Display a confirmation screen to end 1Seg watching after a specified time has elapsed with no operation. Auto off if no operation is not set if you select [OFF]. <ul style="list-style-type: none"> • Off timer is given priority when Off timer is also set.
Reset channel setting	Delete all channel lists to reset to the blank state.

Reset storage area	Delete broadcasting data saved by each affiliated station.
Reset TV settings	Restore the default 1Seg settings.

*1 Settings are automatically changed when you operate [Display switch] in the 1Seg function menu.

Setting Channels

Setting a Channel List

Set a channel list corresponding to the region of use.

1 1Seg watching screen ►  ► [Settings] ► [Channel setting] ► Perform operations listed below:

Select area	Select an area in which you watch 1Seg from the area list to set a channel list.
Setting from my location	Search for available channels in the current location and automatically add detected channels to the channel list.

Information

- You may not be able to add channels correctly using [Select area] depending on the area, or if frequencies of broadcasting stations have been changed. In that case, use [Setting from my location] to set a channel list.

Switching Channel Lists

- 1 1Seg watching screen ▶  ▶ [Settings] ▶ [Select channel list]

Select channel list screen is displayed.

2 Tap a channel list to activate

Editing a Channel List

- The currently active channel list cannot be edited.

- 1 Select channel list screen ▶ Touch and hold a channel list to edit ▶ [Channel info] ▶ Touch and hold a channel ▶ Perform operations listed below:

Controller setting	Tap the channel you want to assign a new channel number to and select a new number.
Delete	Delete the selected channel from the channel list.

Using TV Links

Some data broadcasts allow you to save TV links to memo information and associated sites. You can access memo information or associated sites from saved TV links.

Saving a TV Link

- 1 Select the item that can be saved as TV link in the data broadcast area ▶ [Yes]
 - Procedure for saving TV links varies according to programs.

Displaying Information from a TV Link

- 1 1Seg watching screen ►  ► [Settings] ► [TVlink]

TV link list screen is displayed.



MEMO: Memo



BML: Link content



HTML: HTML content



!: Expired (unavailable)

- 2 Tap the TV link from which you want to view information

Creating a TV Link Shortcut in Home Screen

- 1 TV link list screen ► Touch and hold a TV link to create shortcut ► [Make shortcut]

Deleting TV Links

- 1 TV link list screen

- 2 **To delete a TV link**
Touch and hold a TV link to delete ► [Delete] ► [Yes]

To delete all TV links

 ► [Delete all] ► [Yes]

To select multiple TV links to delete

 ► [Delete selected] ► Mark TV links to delete ►  ► [Delete] ► [Yes]

ToruCa

ToruCa is an electronic card that can be imported into mobile phones. Available online, it provides shopping information or serves as a coupon. The imported ToruCa is saved in the “ToruCa” application that allows you to view, find or update a ToruCa.

For details on ToruCa, refer to “ご利用ガイドブック (spモード編) (Mobile Phone User’s Guide [sp-mode])” (in Japanese only) or docomo market.

- Read Software Licence Agreement (in Japanese only) for initial startup, and tap [同意する(Accept)].

Information

- Packet communication fee may be incurred when you import, view or updated a ToruCa.
- You may not be able to import, view or update a ToruCa which has been provided for i-mode terminals.
- Depending on the settings by the IP (Information Provider), the following functions may not be available:
Update, sending by mail, moving or copying to microSD card, and map display.
- Depending on the IP settings, a ToruCa may not be able to display a map from the ToruCa list, even when the ToruCa (details) can display a map.
- When the duplicate check is set to “ON”, you cannot import the same ToruCa more than once. To import the same ToruCa more than once, set the duplicate check to “OFF”.
- When sending a ToruCa by mail, it is sent in the state before importing the ToruCa (details).
- You may not be able to save a ToruCa received by mail, depending on the mail application used.
- You may not be able to import a ToruCa depending on the browser used.
- When moving or copying a ToruCa to microSD card, it is moved or copied in the state before importing the ToruCa (details).

YouTube

YouTube is Google's online video streaming service. You can play and upload videos.

1 Home screen ► ► [YouTube]

- Read mobile terms of service at initial startup and tap [Accept].

2 To play a video

Tap a video to play

- Tap the screen to pause/resume the video.
- In horizontal display, you can specify a playback position by dragging the slider.
- Tap [HQ] to switch high-quality (HQ) playback on/off.

To upload a video

 ► [Upload] ► Select a video ► Enter necessary items ► [Upload]

- Tap  to shoot a video to upload.

News & Weather

You can check weather information and news.

1 Home screen ▶ ▶ [News & Weather]

Top screen for news or weather is displayed.

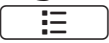
- Flick the top tab right and left to switch categories of weather and news, or flick the screen right and left.
- Press  ▶ [Refresh] to update to the latest information.

2 Tap the item you want to view the details

Setting Menu for News & Weather

1 News or weather top screen ▶ ▶ [Settings] ▶ Perform operations listed below:

Weather settings	Use my location	Mark this checkbox to search for current location and show weather information around the location.
	Set location	Specify target area of weather information when [Use my location] checkbox is unmarked. <ul style="list-style-type: none">• Even when specifying an area in Japan, enter the city name in the Roman alphabet. Also, when entering the postal code, make sure you enter a space followed by "jp" or "Japan" afterwards.
	Use metric	Mark this checkbox to indicate temperatures in Celsius.

News settings	Select news topics	Select news categories to show.
	Prefetch articles	Mark this checkbox to download and show articles.
	Prefetch images	Mark this checkbox to download images along with articles. This option is available when [Prefetch articles] is marked.
	News terms of service	Show news terms of service.
	Mobile privacy policy	Show Mobile privacy policy of Google.
Refresh settings	Auto-refresh	Mark this checkbox to automatically update to the latest information.
	Refresh interval	Set refresh interval when [Auto-refresh] is marked.
	Refresh status	The last update date and time are displayed.
Application version		News & Weather version is displayed.

Clock

This mobile phone can be used as a desk clock.

1 Home screen ► ► [Clock]

Clock screen is displayed.

: Dim the screen. To restore the original brightness, tap the screen.

: Display the Alarms screen.

: Start slideshow using still images.

: Start the music player.

: Display the home screen.

- When setting the current location and position information for News & Weather, the weather forecast will be displayed. Tap weather forecast to start News & Weather.
- After several minutes have elapsed without any operation, screen-saver mode is activated in which only the date and time are displayed. Tap the screen to return to the clock screen.

Setting an Alarm

1 Clock screen ►

Alarms screen is displayed.

2 [Add alarm] ► Set the alarm time

3 Set other item(s) as necessary



4 [Done]

Stopping Alarm/Setting Snooze

Tap [Dismiss] in the alarm notification screen to stop the alarm. Tap [Snooze] to activate the alarm after a certain time. To cancel the snooze setting, tap [Alarm (snoozed)] in the notification panel.

Advanced Settings of Alarm

1 Alarms screen ►  ► [Settings] ► Perform operations listed below:

Alarm in silent mode	Mark this checkbox to activate alarm in Silent mode.
Alarm volume	Set alarm volume.
Snooze duration	Set the snooze duration if you activate snooze in the alarm notification screen.
Volume key behavior	Set behavior (None/Snooze/Dismiss) triggered when  /  is pressed while alarm is sounding.

Calendar

You can synchronize this mobile phone calendar with online service calendars such as Google Calendar to manage your schedule.

- Set your Google account ( P.83) in advance.

Displaying Calendar

1 Home screen ► ► [Calendar]

Calendar screen is displayed.

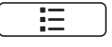
- Press  ► [Day]/[Week]/[Month]/[Agenda] to switch display formats.

Setting Calendars to Synchronize/Display

If you use more than one calendar of online services such as Google Calendar, set calendars to synchronize with this mobile phone and those to be displayed on the mobile phone.

1 Calendar screen ► ► [More] ► [Calendars] ► Select an account

2 Tap each calendar to select



: Synchronize and display



: Synchronize and hide



: Not synchronize and hide

3 [OK]

Displaying Event Details



1 Calendar screen ► Tap an event

- For monthly display, tap a date with any event and then tap an event.

Adding an Event

1 Calendar screen ►  ► [More] ► [New event]

2 Enter event name, date and time, place and description

- If you set more than one calendar, select the calendar to which you want to add the event.
- Tap  to add more notifications.
- Press  ► [Show extra options] to enter additional items.
- Enter mail address in [Guests] field to invite a friend to the event.

3 [Done]

When Event Is Notified

When  appears in the status bar, dismiss notification/ configure snooze setting by following the procedure below:

1 Open the notification panel and tap the notification

- Tap the event to display details and dismiss the notification.

2 Perform operations listed below:

Snooze all	Snooze all event notifications for five minutes.
Dismiss all	Dismiss all event notifications.

Changing Calendar Settings

- 1 Calendar screen ►  ► [More] ► [Settings]
► Perform operations listed below:

Hide declined events	Hide events you declined.
Use home time zone	Mark this checkbox to show the calendar times in your home time zone during roaming.
Home time zone	When [Use home time zone] checkbox is marked, specify the time zone of your home region.
Set alerts & notifications	Selecting [Alert] will show  in the status bar upon notification and the notification screen will appear at the same time. No notification will be generated if you select [Off].
Select ringtone	Set ringtone for notification.
Vibrate	Set whether to keep vibration always on/off upon notification, or to turn it on only in Silent mode.
Default reminder time	Set the time to notify of events (what minutes/hours/days before the event start time).
Build version	Calendar version is displayed.

Calculator

1 Home screen ►  ► [Calculator]

2 Enter a formula in the formula field at the top ►
[=]

- Flick the button display right or left, or tap  ► [Advanced panel]/[Basic panel] to switch advanced/basic calculation screens.
- Touch and hold the formula field to copy/paste the formula.
- Tap [CLEAR] to clear characters you entered. Touch and hold [CLEAR] to clear the entire formula.

ECONAVI

By switching to the eco mode, you can reduce battery consumption.

You can also set the mobile phone to [Auto eco] so that it automatically switches to the eco mode when the battery level goes below the preset level.

Switching to the eco Mode

1 Home screen ►  ► [ECONAVI] ► [ON]

eco Mode Setting

1 Home screen ►  ► [ECONAVI] ► [eco mode setting]

2 Perform operations listed below:

Auto eco mode setting	Set a battery level at which the mobile phone is switched to eco mode. The mobile phone is not switched to eco mode if [Always OFF] is selected. The mobile phone is always in the eco mode regardless of battery level if [Always ON] is selected.
eco mode setting	Set behavior of each function in the eco mode. Note that if you change the relevant settings in the setting menu while in the eco mode, these changes are not reflected until the eco mode is canceled.

3 [OK]

Information



- When the [Wi-Fi sleep policy] ( P.90) is set to [Never], the Wi-Fi connection will not be disconnected and become invalid, even when [Wi-Fi] is checked under [eco mode setting].

Barcode Reader

You can have Barcode Reader read QR codes and JAN codes using the camera. After a QR code or JAN code is read, you can make a call, send a mail, add a contact to the phonebook, view a website, etc., depending on the content of characters read from the code.

- Some QR codes may be unreadable depending on the QR code version, type and size.
- Some codes may be unreadable due to scratch, dirt, damage, poor print quality or reflecting light.

■ QR code and JAN code

QR code	Two-dimensional code representing data in vertical and horizontal directions. This mobile phone can read concatenated QR codes consisting of up to 16 segments.	 Example of read information: 株式会社NTTドコモ (NTT DOCOMO, INC.)
JAN code	Barcode representing numbers with vertical lines (bars) of different widths. This mobile phone can read 8-digits (JAN8) or 13-digits (JAN13) JAN codes.	 4 942857 112597 Example of read information: 4942857112597

Reading a QR Code/JAN Code

1 Home screen ▶ ▶ [バーコードリーダー(Barcode Reader)]

Shooting screen is displayed.



: Display menu



: Display history screen



: Stop reading/Reread





: End Barcode Reader

2 Display QR code/JAN code in the shooting screen

Read result screen is displayed.

3 Tap read characters

A menu corresponding to the content of characters appears.

- You can flick the title bar right and left to switch entire text/read result screens.
- Tap  to return to the shooting screen.
- For operations in each screen, refer to function descriptions, which can be shown by tapping  ▶ [ヘルプ (Help)].

Information

- You cannot share a read result correctly when the read result is not URL information, even if you tap  in the read result screen ▶ [共有する (Share)] and select [Bluetooth]/[Facebook]/[Twitter]/[Web page widget (docomo Palette UI)].
- Depending on the application used for sharing, login operation may be necessary, or sharing may not be done correctly due to restrictions of the application.

Catalyst Reader

You can view PC documents saved in microSD card (Office documents, PDF files, etc.).

■ Supported files



- Documents using fonts not installed in the mobile phone may not be displayed correctly, because incompatible fonts are substituted by some other fonts to display the documents.
- Some files may not be displayed even though they are supported files.

File type
Word file (Microsoft Word 2003, 2007 and 2010)
Excel file (Microsoft Excel 2003, 2007 and 2010)
PowerPoint file (Microsoft PowerPoint 2003, 2007 and 2010)
PDF file (Adobe PDF 1.5)
Text file (shifted JIS and UTF-8)

Viewing a Document

1 Home screen ►  ► [Catalyst Reader]

2 Tap a document to open

- Tap the screen to show zoom control and you can zoom in/out the document. You can also pinch out/in to zoom in/out. Tap  /  to go to previous/next page.

Information

- The text file cannot be sent, even if you open a text file ▶  ▶ [Share] ▶ [Facebook]/[Twitter].
- Depending on the application used for sharing, login operation may be necessary, or sharing may not be done correctly due to restrictions of the application.

SD backup

You can back up phonebook data, received/sent/unsent messages (SMS) and bookmarks in this mobile phone to microSD card.

Backing Up Data to microSD Card

1 Home screen ►  ► [SD backup] ► [Backup to microSD] ► Enter terminal password ► [OK]

- If terminal password is not set,  step 3 to 4 in P.133 "Setting Terminal Password"

2 Tap data to back up ► [Yes]

3 When backup is completed, [OK]

Restoring Backup Data to Mobile Phone

1 Home screen ►  ► [SD backup] ► [Restore to main body] ► Enter terminal password ► [OK]

2 Tap data to restore ► [Replace]/[Addition] ► Tap a file to restore ► [Yes]

3 When restoration is completed, [OK]

- Restored phonebook data is saved to the docomo account.
- When you restore an unsent message (SMS), only message part is restored. Touch and hold the restored unsent message (SMS) ► [Forward] to enter address.

Deleting Backup Data

- 1** Home screen ▶  ▶ [SD backup] ▶ [Deletion of backup data] ▶ Enter terminal password ▶ [OK]
- 2** Tap data to delete ▶ Mark file(s) to delete ▶ [Deletion execution] ▶ [Yes]
- 3** When deletion is completed, [OK]

Overseas Use

Overview of International Roaming (WORLD WING)

International roaming (WORLD WING) is a service that allows you to use in the service areas of overseas operators affiliated with DOCOMO with the same phone number and mail address as used in Japan. You can use the call and message (SMS) features without changing the settings.

- Available areas
This mobile phone can be used in 3G network and GSM/GPRS network service areas. It can also be used in countries and regions where 3G 850 MHz/GSM 850 MHz are available. Check available areas.
- Refer to the following documents before using the mobile phone abroad:
 - “Mobile Phone User’s Guide [International Services]”
 - DOCOMO International Services website
 - “ドコモ海外利用 (docomo Overseas Use)” application help

Information

- For country codes, international phone access number, international prefix for universal number, connectable countries and regions and overseas operators, refer to “Mobile Phone User’s Guide [International Services]” and DOCOMO “International Services website”.

Available Services

(○: Available —: Unavailable)

Main communication services	3G	GSM/ GPRS	GSM
Call	○	○	○
Message (SMS)	○	○	○
Mail*1	○	○	—
Browser*1	○	○	—
Locating current position with GPS*2	○	○	—

*1 To use data communication feature during roaming, mark [Data roaming] checkbox (☞ P.230).

*2 GPS positioning (locating current position) costs packet communication fees.

Information

- Some services may be unavailable depending on overseas operators and networks to connect.

Confirmation before Use

Confirmation before Departure

If you use the mobile phone abroad, check the items indicated below while you are still in Japan.

About Subscription

- Check your WORLD WING application status. For details, contact “General Inquiries” on the back page of this manual.

About Charges

- Overseas usage charges (call charge, packet communication fee) differ from domestic usage charges.
- Some applications perform data communication automatically. Packet communication fees may be expensive. It is your responsibility to check the behavior of applications with their respective providers.

Preliminary Settings

About Network Service Settings

If you subscribe to network services, you can use network services such as Voice Mail Service, Call Forwarding Service, and Caller ID Display Request Service overseas. However, some network services are unavailable.

- To use network services abroad, it is necessary to start “remote operation settings”. You can configure “remote operation settings” overseas.
- The network services, even if they can be set on/off, may not be available depending on the overseas operator you use.

Confirmation in the Country You Stay





When you arrive at your overseas destination and power on the mobile phone, it automatically connects to an available operator's network.

About Connection

If you set [Available networks] to [Select automatically] in [Network operators] setting, an optimal network is automatically selected (👉 P.229).

By manually setting [Available networks] to connect to an overseas operator compatible with flat-rate service, you can use a billing plan in which overseas packet communication fee is calculated on a daily basis and you will not be charged a fee exceeding a certain limit. Subscription to flat-rate packet service is necessary to use the service. For details, refer to "Mobile Phone User's Guide [International Services]" or DOCOMO International Services website.

About Screen Display

- The network type in use is displayed in the status bar.
 - : Roaming
 - : Connecting to GPRS/GPRS in use
 - : Connecting to EDGE/EDGE in use
 - : Connecting to 3G (packet)/3G (packet) in use
- The name of the connected overseas operator is shown in the notification panel.

About Date and Time

When [Date & time] is set to [Automatic], this mobile phone's time and time difference are corrected by receiving information from the network of the connected overseas operator.

- Depending on the network of overseas operator, the time/time difference correction may not be performed correctly. In this case, time zone should be set manually.
- Correction timing varies depending on the overseas operator.
- 👉 P.142 "Date & Time"

About Inquiry

- In case this mobile phone or UIM is lost or stolen overseas, contact DOCOMO immediately from where you are and take the procedure to suspend the service. For contact information, refer to the back page of this manual. Note that you are liable for any call and data communication charges incurred after loss or theft.
- You will need the international call access code or universal number international prefix assigned to the country where you stay, if you call from a land-line phone.

Settings for Overseas Use

Although by default, the mobile phone automatically searches for and connects to an available operator's network when you arrive overseas, you can manually configure settings.

Setting Network Mode

1 Home screen ►  ► [Setting] ► [Wireless & networks] ► [Mobile networks] ► [Network Mode]

2 Perform operations listed below:

WCDMA only	Use 3G network.
GSM only	Use GSM network.
GSM/WCDMA	Automatically switch to the available network.

Setting Network Operator to Connect

1 Home screen ►  ► [Setting] ► [Wireless & networks] ► [Mobile networks] ► [Network operators]

After searching for available networks, a list of operators is displayed in Available networks screen.

- To repeat network search, tap [Search networks].
- If an error occurs in network search, unmark [Data enabled] checkbox ( P.117) and try again.

2 Tap the operator you want to connect

- To automatically set an operator to connect, tap [Select automatically].

Information

- If you manually set an operator overseas, set available networks to [Select automatically] after returning home.

Setting Data Roaming

1 Home Screen ▶  ▶ [Setting] ▶ [Wireless & networks] ▶ [Mobile networks]

2 Mark [Data roaming] check box ▶ [OK]

Making/Receiving Calls in the Country You Stay

Making Calls to Other Countries (Including Japan)

You can make international calls from the country you stay to other countries by using the international roaming service.

- For available countries and operators, refer to DOCOMO International Services website.

1 Home screen ►  ► [Phone]

2 Enter + (touch and hold [0]) ► Country code ► Area code ► Phone number ► 

- If the area code starts with “0”, omit “0”. However, “0” is necessary for some countries and regions such as Italy.
- If the other party is an overseas subscriber to “WORLD WING”, enter “81” (Japan) as the country code regardless of where the other party is.
- When [International dial assist] checkbox in [Call settings] is marked (☑ P.120), you can make a call to Japan by entering a phone number with area code as you do in Japan ► [Call to Japan] ► [OK].

Making Domestic Calls in the Country You Stay

You can make calls to land-line phones or mobile phones in the same way as you do in Japan.

1 Home screen ►  ► [Phone]

2 Enter phone number with area code ► 

- If the other party is a subscriber to “WORLD WING”, enter “81” (Japan) as the country code even when you make a call to the country you stay.
- When [International dial assist] checkbox in [Call settings] is marked ( P.120), enter phone number with area code ► [As is call] ► [OK].

Receiving Calls in the Country You Stay

You can receive calls in the same way as you do in Japan.

Information

- If you receive a call during international roaming, the call is processed as international call forwarded from Japan regardless of where the caller is. The caller is charged for call to Japan while the receiver is charged a call reception fee.

Procedure for the Other Party to Make a Call to You

■ Having the other party make a call from Japan

The caller only need to dial the phone number as he/she normally does in Japan.

■ Having the other party make a call from a country other than Japan

Since the call is forwarded via Japan regardless of where the caller is, the caller must dial international call access code and “81”. International call access code of the originating country -81-90 (or 80)-XXXX-XXXX

Confirmation after Returning Home

When you return to Japan, the mobile phone automatically connects to the DOCOMO network. If not, take following actions to establish connection:

- Set [Preferred network mode] in [Network Mode] to [GSM/WCDMA] (☞ P.229).
- Set [Available networks] in [Network operators] to [Select automatically] (☞ P.229).

Appendix

Optional Items and Associated Equipment

Combining various options with this mobile phone, you can realize more versatile use from personal to business purposes.

Some products may not be dealt in depending on the area. For details, consult a handling counter such as a docomo Shop.

For details on optional items, refer to the user's manuals of respective options and related devices.

- Battery Pack P25
- Back Cover P53
- AC Adapter Cable P01*1
- FOMA Portable Charging Adapter 02*2
- Pocket charger 01
- Carry Case 02
- In-Car Holder 01
- Bluetooth Headset F01*3
- AC Adapter for Bluetooth Headset F01
- Wireless Earphone Set P01
- Wireless Earphone Set 02
- Bone conduction microphone/receiver 02
- In-Car Hands-Free Kit 01

*1 For charging procedure,  P.41

*2 Connect a microUSB cable for use.

*3 AC Adapter for Bluetooth Headset F01 is required.

Troubleshooting (FAQ)

When You Have Any Trouble

- First of all, check if the software needs to be updated. If update is necessary, update the software (☞ P.248).
- If the symptom does not improve after taking actions listed in the check item, feel free to contact “Repairs” on the back page of this manual or a repair counter specified by DOCOMO. The “Repairs” counter is available in Japanese only.

■ Power supply



Symptom	Check item
Cannot turn the mobile phone on	<ul style="list-style-type: none">• Make sure that the battery pack is installed properly (☞ P.39).• Check if the battery has run out (☞ P.41).



■ Charging

Symptom	Check item
Cannot charge (Charging indicator does not light, or it flickers)	<ul style="list-style-type: none"> • Make sure that the battery pack is installed properly (☞ P.39). • Make sure that the power plug of the included AC adapter is securely inserted into the outlet (☞ P.42). • Make sure that the included microUSB cable is securely connected with this mobile phone and AC adapter (☞ P.42). • Make sure that the PC is powered on when this mobile phone and a PC are connected using the included microUSB cable (☞ P.43). • If you talk on the mobile phone, use data communications or operate other functions for a long time during charging, temperature of the mobile phone may rise to flicker the charging indicator at about 5 seconds interval. In such case, disconnect the AC adapter cable from the mobile phone and then start charging again after the mobile phone is cooled down.









■ Operations of the mobile phone

Symptom	Check item
Get heated during operations or charging	<ul style="list-style-type: none"> • If you operate the mobile phone for a long time, watch 1Seg for a long time during charging, or just charge the battery for a long time, the mobile phone, battery pack and/or AC adapter cable may become warm. This does not pose any safety hazard, so you can keep using the mobile phone (☞ P.23, P.25, P.41).



Symptom	Check item
Usable time of the battery pack is short	<ul style="list-style-type: none"> • Check if the mobile phone is left out of service area for a long time. While being out of service area, the mobile phone consumes more power to search for radio wave to establish communication (☞ P.263). • The usable time of the battery pack differs depending on the usage environment and its remaining life (☞ P.263). • The battery pack is a consumable item. Usable time per charge gradually decreases with repeated charging. When its usable time is extremely short compared with that at the time of purchase, buy a specified battery pack (☞ P.41).
Unwanted shutdown and restart	<ul style="list-style-type: none"> • Poor contact due to dirt on battery pack terminal may cause shutdown. Wipe off the battery pack terminal to remove any dirt with a dry cotton swab (☞ P.22).
Not respond to tapping the touch panel/pressing the keys	<ul style="list-style-type: none"> • Check if the mobile phone is in Sleep mode. To cancel the Sleep mode, press  or  (☞ P.44). • Turn the power off and on again (☞ P.44).
Delayed response to tapping the touch panel/pressing the keys	<ul style="list-style-type: none"> • This is likely to occur when a massive amount of data is stored in the mobile phone or it is exchanging large data with microSD card.
UIM not recognized	<ul style="list-style-type: none"> • Make sure that the UIM is inserted in the correct orientation (☞ P.35).
Clock shows wrong time	<ul style="list-style-type: none"> • The clock may show wrong time when the mobile phone is left on for a long time. Make sure that [Automatic] checkbox in Date & Time is marked, and then turn the power off and on again in a location with a strong radio wave (☞ P.142).

Symptom	Check item
Operation is unstable	<ul style="list-style-type: none"> • This could be due to the installation of applications to the mobile phone after purchase. Start up your mobile phone in Safe mode, and if the symptoms are fixed, then try uninstalling your applications. Sometimes this can fix the symptoms. <ul style="list-style-type: none"> * Safe mode is a function that starts up your mobile phone in a state that is close to that at the time of purchase. • Activating Safe mode <ul style="list-style-type: none"> Press  for two seconds or more when the mobile phone is turned off, and in the time from when the docomo logo is displayed to when the home screen is displayed, hold down . * When Safe mode is activated, "Safe mode" is displayed on the screen. * To end Safe mode, once turn off the power and restart. • After backing up important data in advance, use Safe mode. • Widgets created by yourself may disappear. • Since Safe mode is not the regular startup status, please exit Safe mode before using the mobile phone for regular operations.

■ Call

Symptom	Check item
Cannot make calls by tapping 	<ul style="list-style-type: none"> • Check if FDN (Fixed Dialing Numbers) is set ( P.120). • Check if [Flight mode] checkbox is marked ( P.116).
No ringtone	<ul style="list-style-type: none"> • Check if the ringer volume is set to silent ( P.122). • Check if the Silent mode is set ( P.97). • Check if the ring time for Voice Mail or Call Forwarding Service is set to "0 second" ( P.108, P.110).
Cannot make/receive calls (Out of service area icon is still displayed even after moving to different places, or cannot make/receive calls despite a strong radio wave)	<ul style="list-style-type: none"> • Turn the power off and on again, or reinstall the battery pack or UIM ( P.35, P.39, P.44). • Due to the nature of radio waves, you may not be able to make or receive calls even when the radio wave is strong enough and the four-bar antenna mark () is shown. Try again in a different location. • Check if you restrict incoming calls by configuring call reject setting, etc. ( P.120) • In places where many people gather, the call and messaging lines may become busy resulting in bad connections. In such case, [All calls are restricted by access control.] is displayed and a busy tone is given. Try again after a while or in a different place.

■ Screen

Symptom	Check item
Dark display	<ul style="list-style-type: none"> • Check if you have changed the brightness ( P.124). • Check if the brightness is reduced by setting ECONAVI ( P.217).

■ Sound

Symptom	Check item
Cannot hear the voice of the other party, or the voice is too loud	<ul style="list-style-type: none">• Check if you have changed the in-call volume (☞ P.98).

■ Data display

Symptom	Check item
Images and melodies you set in individual functions are ignored, and the default settings are used	<ul style="list-style-type: none">• Make sure that the same UIM is installed as when you obtained the images and melodies.

■ Mail

Symptom	Check item
Cannot receive Emails automatically	<ul style="list-style-type: none">• Check if [Inbox check frequency] in Account settings of Email application is set to [Never] (☞ P.150).

■ Camera

Symptom	Check item
Still images and videos shot by the camera are blurred	<ul style="list-style-type: none">• Check for cloudiness or dirt on the lens (☞ P.175).• Use [Stabilization Shot] for shooting (☞ P.177).

■ 1Seg



Symptom	Check item
Cannot watch 1Seg	<ul style="list-style-type: none">• Check if the mobile phone is out of service area of the terrestrial digital TV broadcasting or if broadcasting waves are weak (☞ P.199).• Make sure that you have set channels (☞ P.204).

■ Overseas use

Symptom	Check item
Cannot use the mobile phone abroad	<ul style="list-style-type: none"> ● If the antenna mark is displayed: <ul style="list-style-type: none"> • Check if you have applied for WORLD WING. Check your WORLD WING application status. ● If the out of service area icon is displayed: <ul style="list-style-type: none"> • Check if the mobile phone is out of service area of international roaming service or if the radio wave is weak. Check for available service areas or overseas operators referring to “Mobile Phone User’s Guide [International Services]” or DOCOMO International Services website. • Try different network modes and/or network operators. Set [Network Mode] to [GSM/WCDMA] (☞ P.229). In [Network operators], search for available operators for this service (☞ P.229). • The problem may be solved by turning the power of the mobile phone off and on again (☞ P.44).
Cannot establish data communication abroad	<ul style="list-style-type: none"> • Mark [Data roaming] checkbox (☞ P.230).
Mobile phone was suddenly shut off during overseas use	<ul style="list-style-type: none"> • Check if the approximate limit for service suspension has been exceeded. An approximate limit is preset for suspending the use of “International roaming service (WORLD WING)”. If the approximate limit has been exceeded, pay the accumulated usage charges (☞ back page of this manual).
Cannot receive calls abroad	<ul style="list-style-type: none"> • Check if Network Mode is set to other than [GSM/WCDMA] (☞ P.229).

Symptom	Check item
The other party's phone number is not notified/ Notified phone number is different from that of the other party/ Function to display contact information or caller ID notification does not work	<ul style="list-style-type: none"> • Even when the other party notifies the caller ID, the ID is not displayed on this mobile phone unless notified from the network or operator used. Moreover, a number different from the other party's phone number may be displayed depending on networks or operators used.

■ Data management

Symptom	Check item
Data transfer fails	<ul style="list-style-type: none"> • Check if a USB hub is used. Use of a USB hub may hinder proper operation.
Data saved in microSD card is not displayed	<ul style="list-style-type: none"> • Reinstall the microSD card (📄 P.37).
 appears upon attempt to view image, or  appears in demo or preview mode	<ul style="list-style-type: none"> •  may appear if image file is corrupted.

■ Bluetooth function

Symptom	Check item
Cannot connect/find Bluetooth devices by device search	<ul style="list-style-type: none"> • Bluetooth device (commercial product) must be registered on this mobile phone with the device in wait state. To remove a registered device and then register again, remove each other on both of the Bluetooth device (commercial product) and this mobile phone in advance (📄 P.168).

Symptom	Check item
Cannot make calls from this mobile phone with external device such as car navigation system and hands-free device connected	<ul style="list-style-type: none"> If you try to make a call to the same number several times while the other party does not answer because he/she is out of service area, etc., it may become impossible to call to the number. In such case, turn the power of this mobile phone off and on again (☞ P.44).

Error Messages

Error message	Description/Action
No SIM card.	Displayed if the UIM is not installed when you tap the My Details field. Check that the UIM is properly installed (☞ P.35).
Inserted SIM card cannot be used by this phone. Please insert effective SIM card.	Displayed when another operator's SIM card is installed.
The remainder of the battery doesn't suffice. It is not possible to initiate the processing.	Displayed when SD backup is attempted when the battery level is low. Fully charge the battery and try again (☞ P.41).

Warranty and After-Sales Service

About Warranty

- Make sure that you have received a warranty card provided at purchase. After checking the contents of the warranty card as well as “Shop name and date of purchase”, keep the warranty card in a safe place. If you notice that necessary items of the warranty card are not filled in, immediately contact the shop where you purchased this mobile phone from. The term of the warranty is one year from the date of purchase.
 - All or part of this product including the accessories may be modified for improvement without notice.
 - Information stored in the phonebook etc. might be changed or reset depending on the troubles and repairs, or the way you handle the mobile phone. Keep a copy of information stored in the phonebook etc. just in case.
- * You can save phonebook data of this mobile phone to microSD card.

About After-Sales Service

If the Mobile Phone Is Not Working Right

Before asking repairs, check “When You Have Any Trouble” in this manual.

If the problem remains unsolved, contact “Repairs” on the back page of this manual.

If Repair Is Necessary after Inquiry

Bring your mobile phone to a repair counter specified by DOCOMO. Note that your mobile phone is accepted for repair during the repair counter’s business hours. You will need to bring the warranty card to the counter. Further, note that you may need to wait for fixing depending on the malfunction state.

■ In warranty period

- Your mobile phone is repaired charge free in accordance with the terms of warranty.
- Make sure that you bring the warranty card to the counter for repair. If you do not show the warranty card, or when troubles or malfunctions are regarded to be caused by your mishandling (the damages of LCD, connector, etc.), the repair cost is charged even within the warranty period.
- The cost for troubles caused by the use of devices and consumables other than those specified by DOCOMO is charged even within the warranty period.

■ Repairs may not be carried out in the following cases:

- When exposure to water is found at our repair counter (Example: When the moisture detection sticker has reacted)
- When, as a result of inspection at our repair center, corrosion is found due to exposure to water, dew condensation, or sweat, or when damage or deformation is found in the circuit board (Repairs might not be carried out when damage to the connector terminal (earphone/microphone terminal) or LCD, or cracks in the casing are found.)
- * Even if repair is feasible, the repair cost is charged when the trouble you suffer matches one of the cases listed above, which is not covered by the warranty.

■ After the warranty period

We will repair your mobile phone on request (charges will apply).

■ Spare parts availability period

The minimum storage period of the performance spare parts (parts required for maintaining performance) for the mobile phone is basically six years after the closure of its production. Note, however, that your mobile phone might not be repaired depending on the troubled portions because of the shortage of spare parts. Repair may be possible depending upon troubled portions after the availability period. Contact the "Repairs" counter listed on the back page of this manual for details.

Notes

- Make sure not to modify the mobile phone or its accessories.
 - Fire, injury or malfunction may result.
 - We accept to repair malfunction with modified device subject to your agreement with possibility that we restore the modifications. We might reject to repair depending on the degrees of your modification.
The following might be regarded as modifications:
 - To put stickers, etc. onto the LCD or keys
 - To decorate the mobile phone using adhesives
 - To replace the coverings etc. with those of other than DOCOMO genuine products
 - Repairs of troubles or malfunctions resulting from the modifications are charged even within the warranty period.
- Do not peel the nameplate off this mobile phone. The nameplate serves as a certification of technical standard. Note that when we cannot ensure the contents described on the nameplate (the nameplate is peeled off intentionally or replaced) and therefore cannot verify the product conformity to the technical standard, it might happen that we at DOCOMO reject to repair the malfunction.
- The information such as about function settings, etc. might be reset depending on the troubles or repairs, or the way you handle the mobile phone. Set the settings again.
- If the mobile phone is repaired, the Wi-Fi MAC Address and the Bluetooth Address may change, regardless of the area that was originally damaged.
- The parts generating magnetism are used in the following portions of this mobile phone. Note that if you place a magnetism-sensitive object such as a cash card near this mobile phone, the card might become unusable.
Portions: speaker, earpiece
- If the mobile phone gets wet or becomes moist, immediately turn off the power and remove the battery pack; then visit a repair counter. Note, however, that it may not be possible to repair the mobile phone depending on its condition.

Memory Dial (Phonebook Function) and Downloads etc.

Data you have created, imported or downloaded into your mobile phone might be altered or lost when you change the model or the mobile phone is repaired. We assume no responsibility for such alteration or loss of data. Moreover, instead of repairing your mobile phone, we may replace it with another one at our discretion, in which case it is not possible to transfer these data to the replacement terminal with some exceptions.

Software Update

About Software Update

Software Update is a function that connects to the network to check whether P-01D software update is necessary or not. If necessary, Software Update will download part of software through packet communication to update the software.

Any necessary software update will be announced in DOCOMO website.

There are three ways to update the software: “automatic update”, “immediate update” and “scheduled update”.

Automatic update: New software is automatically downloaded and updated at a preset time.

Immediate update: The software is updated immediately.

Scheduled update: The software is automatically updated at the time you scheduled for installation of update package.

Information

- Though software may be updated without changing/deleting data including contacts of phonebook, camera images, mails and downloads in the mobile phone, note that data may not be protected depending on conditions of your P-01D (failure, breakage or water damage etc.). It is recommended to back up important data. However, take note that you cannot back up certain data such as downloads.

Notes on Use

- Do not remove the battery pack while updating software. You may fail to update.
- Fully charge the battery before updating software.
- Install a microSD card with sufficient memory space for updating software. If a message is displayed telling that the available space is not sufficient, delete data in the microSD card and try again.
- You cannot update software in the following cases:
 - During call or out of service area
 - International roaming
 - Flight mode
 - Connected to Wi-Fi network
 - OS upgrading
 - Wrong date and time are set
 - Battery level is not sufficient for software update
 - Available space is not sufficient for software update
 - Available space of microSD card is not sufficient for software update
- It may take time to update (download, rewrite) software.
- You cannot make/receive calls, use communication functions, and other functions while updating software. (You can receive voice calls during download. Note that the download is interrupted if you receive a call.)
- For software update, the mobile phone connects to the server (DOCOMO website) through SSL/TLS communication.
- You are advised to update software when radio wave is strong enough with the four-bar antenna mark displayed and while you are not moving.
 - * If software download is stopped due to a bad radio wave condition, try updating software again in a place with a good radio wave condition.
- If software is already updated, [No update is needed.] appears when you check for update.
- If the mobile phone is in international roaming or out of service area, [Failed to start update. Due to no network or roaming.] appears.
- If the battery level is not sufficient for software update, [Failed to start update. Due to low battery. Please recharge and retry later.] appears.

- Messages (SMS) received during software update are stored in the SMS center.
- When updating software, the proprietary information about your P-01D (model name, serial number, etc.) is automatically sent to the server (DOCOMO-managed server for Software Update). We at DOCOMO never use the sent information for purposes other than to update software.
- If you fail to update software programs, [Software update failed. Please visit to a shop near you.] is displayed and you may not be able to do all operations. In that case, you are kindly requested to come to a repair counter specified by DOCOMO.
- If PIN code is set, PIN code entry screen, in which you need to enter PIN code, appears in reboot process after rewrite process.
- Do not start other applications during software update.

Updating Software Automatically (Automatic Update)

New software is automatically downloaded and updated at a preset time.

By default, automatic update setting is set to [Automatic Update].

⬇️ (software update available) appears in the status bar once rewriting is ready. Then you can check the rewriting time, and select whether to change the rewriting time or immediately start rewriting.

If ⬇️ (software update available) remains displayed at the rewriting time, rewriting is performed automatically and ⬇️ (software update available) is cleared.

In case of insufficient battery or during call at the rewriting time, software update does not start until the same time on the following day.

If automatic update setting is set to [Manual Update] or immediate software update system is busy, software cannot be updated automatically.

Setting of Automatic Update

1 Home screen ▶  ▶ [Setting] ▶ [About phone] ▶ [Software Update] ▶ [Configure the software update]



2 Select behavior upon software update notification

- To update software automatically: [Automatic Update]
- Not to update software automatically: [Manual Update]

Procedure When Update is Necessary

When software is downloaded automatically,  (software update available) appears in the status bar.



1 Open the notification panel ▶ Tap the notification

- When software update is necessary, rewriting time is displayed.

2 To perform rewriting at set time

[OK]

- The home screen reappears. Rewriting starts at the set time.

To change rewriting time

[Sets Time] ► (☞ step 1 in P.258 “Updating Software at Scheduled Time (Scheduled Update)”)

- Set the time to install an update package.

To perform rewriting now

[Starts update] ► (☞ step 1 in P.256 “Updating Software Now”)

- Rewriting starts.
- Once rewriting is completed, (software update completed) appears in the status bar.
- disappears once confirmed.

Information

- If software update has failed to start at the time of automatic update,  (software update available) appears in the status bar.

Starting Software Update (Immediate Update)

1 Home screen ►  ► [Setting] ► [About phone] ► [Software Update]

- You can do this by displaying the home screen ►  ► [Setting] ► [About phone] ► [Upgrade features] ► [Update from server] ► [Update software].

2 [Start the software update] ► [Yes]

- Software update is performed automatically once download is started.
- If you cancel download on the way, the data downloaded so far is deleted.

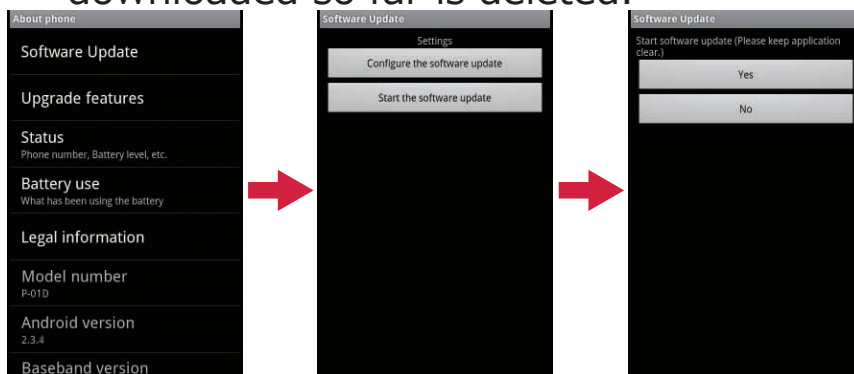

- If software update is not necessary, [No update is needed.] appears.

3 [OK]

- Update starts after reboot.
- During update, all key operations are disabled. Further, you cannot cancel the update.
- Reboot is automatically performed a few times during update.

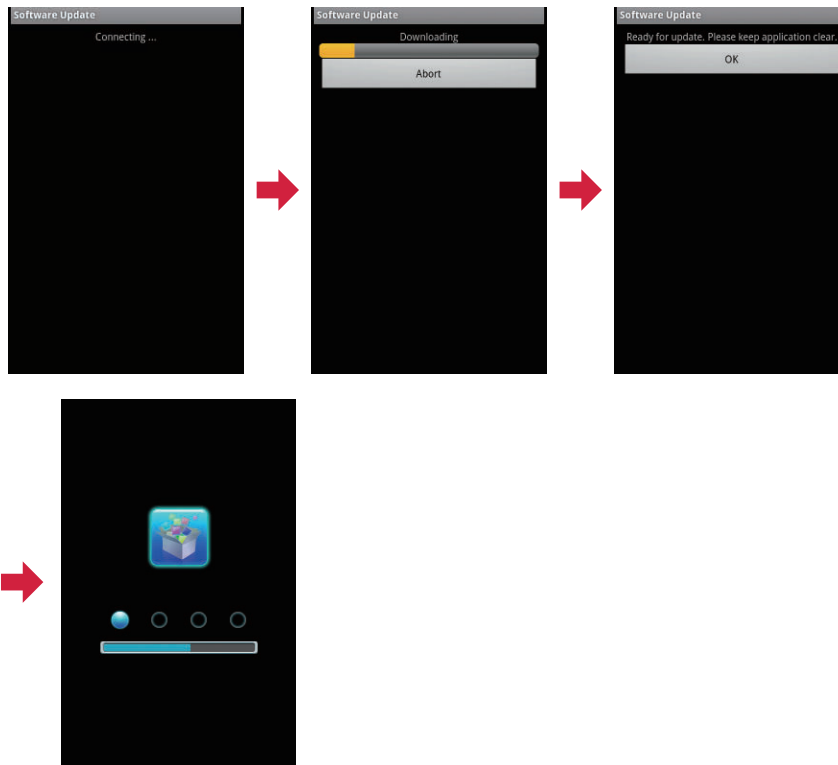

4 Home screen appears

- appears in the status bar. disappears once confirmed.

Updating Software Now

1 [Starts update]

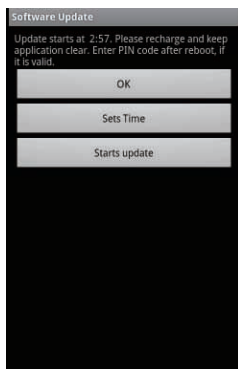

2 [Ready for update.] appears ► [OK]

- After [Ready for update.] is displayed for about three seconds, rewriting is automatically started.
- During rewriting, all key operations are disabled. Further, you cannot cancel rewriting.
- Once rewriting is completed, reboot is performed automatically.

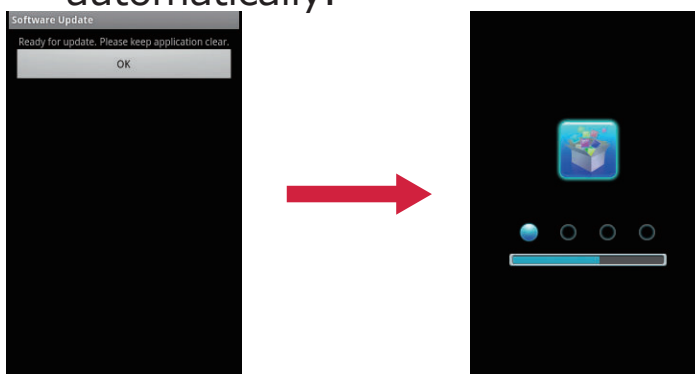

3 After reboot, software update is automatically started

- During update, all key operations are disabled. Further, you cannot cancel the update.
- Once update is completed, reboot is performed automatically after about five seconds.

4 Open the notification panel ► Tap the notification

- Software update is finished and the home screen appears.
- (software update completed) appears in the status bar to indicate completion of the update.
- (software update completed) disappears once confirmed.

About Display After Completion of Software Update

appears in the status bar of the home screen. A message that the software update is completed appears when you open the notification panel.



Updating Software at Scheduled Time (Scheduled Update)

To schedule installation of an update package at another time, you need to set the time for software update in advance.

1 [Sets Time]

- Rewriting start time setting screen is displayed.
- The initial time is displayed according to the clock of P-01D.

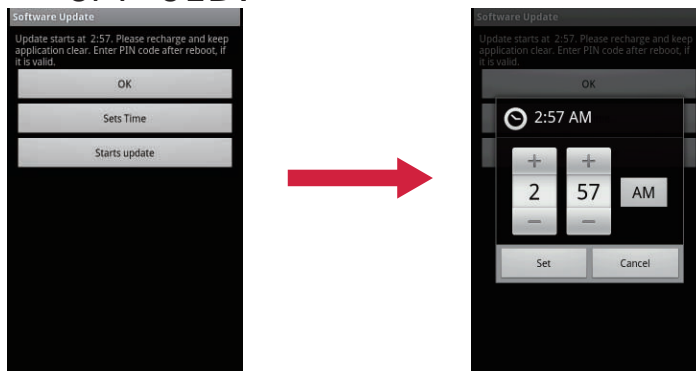

2 Enter preferred time ► [Set]

- Set the time.
- Tap [+] / [-] to change the update time and then tap [Set].

At Scheduled Time

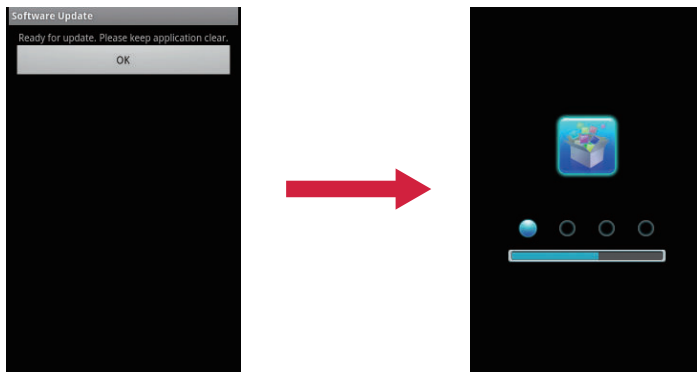

1 [Ready for update.] appears ► [OK]

- After [Ready for update.] is displayed for about three seconds, software update is automatically started.
- At the scheduled time for software update, the home screen should be displayed in a location with a good radio wave condition.
- If the battery level is not sufficient for software update at the scheduled time, software update will be performed at the same time on the following day.
- If OS upgrading is in process at the scheduled time, software will not be updated.
- If an alarm is set at the same time as the scheduled update time, software update is given priority.
- If P-01D is off at the scheduled time for software update, software update will be performed at the same time as the scheduled time after the P-01D is turned on.

Updating Software for Upgrading Features

1 Home screen ►  ► [Setting] ► [About phone] ► [Upgrade features] ► [Update from server]

2 [Update software] ► [Yes] ► [Yes] ► [Start now]

Update file is downloaded.

- When you select [Reserve a time], set the download start time and tap [Yes].

3 Open the notification panel ► Tap the notification

4 [Update Now]

The mobile phone is rebooted and rewriting starts. Once rewriting is completed, the mobile phone is rebooted again and ↓ appears in the status bar.

- When you select [Update later], perform step 3 to 5 later when you update software.

5 Open the notification panel ► Confirm rewriting result ► [OK]

Searching for Latest Software Automatically

1 Home screen ►  ► [Setting] ► [About phone] ► [Upgrade features] ► [Update from server] ► [Settings]

2 Mark [Auto search] checkbox ► [OK]

Information

- Auto search may cost communication fee.

Updating Software from microSD Card

- Obtain new software from Panasonic website and store it in [Download] folder in microSD card in advance.

1 Home screen ►  ► [Setting] ► [About phone] ► [Upgrade features] ► [Update from microSD] ► [OK]

Find new software in microSD card.

2 [OK]

The mobile phone is rebooted and rewriting starts. Once rewriting is completed, the mobile phone is rebooted again and update result is displayed.

3 [OK]

Main Specifications

■ Main unit

Model		P-01D
Dimensions		Approx. 110 mm (H) × Approx. 55 mm (W) × Approx. 12.8 mm (D)
Weight		Approx. 117 g (with the battery pack installed)
Memory		ROM 1024 MB RAM 512 MB
Continuous standby time	FOMA/3G	Standstill (automatic): Approx. 360 hours
	GSM	Standstill (automatic): Approx. 240 hours
Continuous talk time	FOMA/3G	Approx. 250 minutes
	GSM	Approx. 320 minutes
1Seg	Watching time	Approx. 250 minutes
Charging time		AC adapter: Approx. 150 minutes
Display	Type	TFT 262,144 colors
	Size	Approx. 3.2 inches
	Number of dots	480 dots x 800 dots
Image pickup device	Type	CMOS
	Size	1/4.0 inches
Camera	Number of effective pixels	Approx. 5.0 million pixels
	Number of recording pixels (maximum)	Approx. 5.0 million pixels
	Digital zoom	Still image: Approx. 1.6 times at maximum Video: Approx. 1.6 times at maximum

Music playback	MP3 file	Continuous playback time: Approx. 2000 minutes (supports background playback)
Wireless LAN		Compliant with IEEE802.11b/g/n
Bluetooth function	Supported version	Bluetooth standard Ver. 2.1+EDR* ¹
	Output	Bluetooth standard Power Class 2
	Supported profiles*²	HFP, HSP, OPP, A2DP, AVRCP, PBAP

*1 Compliance with Bluetooth standards of this mobile phone and all Bluetooth devices are verified and certified in accordance with procedures set forth by Bluetooth SIG. However, operational method may vary, or data exchange may fail depending on characteristics and specifications of the device connected.

- *2 Standardized procedures to establish connection via Bluetooth communication categorized by product capability
- Continuous talk time refers to estimated time allowed for talk with normal radio wave transmission.
 - Continuous standby time refers to estimated time with normal radio wave reception.
Standby time may be decreased by half according to battery charging status, function settings, use environment such as ambient temperature and radio wave condition (out of reach of radio waves or weak radio wave).
 - Internet access will shorten the talk (communication) and standby time. Even when you do not use call and Internet functions, frequent use of various functions such as mail, 1Seg and other applications will also shorten the talk (communication) and standby time.
 - Continuous standby time in standstill state refers to average standstill usage time with normal radio wave reception.
 - Charging time refers to estimated charging time required to fully charge an empty battery pack with the mobile phone turned off. Charging time may be longer if the mobile phone is on.

■ Battery pack

Name of product	Battery Pack P25
Battery type	Li-ion (lithium ion) battery
Voltage	3.7 V
Capacity	1200 mAh

■ AC adapter cable

Name of product	AC Adapter Cable P01
Input	100 V to 240 V AC 0.14 A, 50/60 Hz
Output	5.0 V DC, 1.0 A
Charging temperature range	5°C to 35°C
Length	Approx. 1200 mm (microUSB cable)

■ File format

Still images and videos shot by this mobile phone are saved in the following file formats:

Type	File format	Extension
Still image	JPEG	jpg
Video	3GPP	3gp

■ Maximum number of shot still images (estimate)

The following are the maximum numbers that can be saved under default conditions.

Resolution	Number of images that can be saved in microSD card (2 GB)*1
5M (2592 × 1944)	Approx. 3278
3M (2048 × 1536)	Approx. 4917
2M (1600 × 1200)	Approx. 6782
WVGA (800 × 480)	Approx. 10244
VGA (640 × 480)	Approx. 10244

*1 Photo Quality: Normal

■ Maximum video recording time (estimate)

The following are the maximum recordable times under default conditions.

Resolution	Time recordable on microSD card (2 GB)*1
WVGA (800 × 480)	Approx. 181 minutes
VGA (640 × 480)	Approx. 222 minutes
QVGA (320 × 240)	Approx. 693 minutes

*1 Video Quality: Normal

Specific Absorption Rate (SAR) of the Phone

This model P-01D mobile phone complies with Japanese technical regulations and international guidelines regarding exposure to radio waves.

This mobile phone was designed in observance of Japanese technical regulations regarding exposure to radio waves* and limits to exposure to radio waves recommended by a set of equivalent international guidelines. This set of international guidelines was set out by the International Commission on Non-Ionizing Radiation Protection (ICNIRP), which is in collaboration with the World Health Organization (WHO), and the permissible limits include a substantial safety margin designed to assure the safety of all persons, regardless of age and health condition. The technical regulations and international guidelines set out limits for radio waves as the Specific Absorption Rate, or SAR, which is the value of absorbed energy in any 10 grams of tissue over a 6-minute period. The SAR limit for mobile phones is 2.0 W/kg. The highest SAR value for this mobile phone when tested for use at the ear is 1.07 W/kg. There may be slight differences between the SAR levels for each product, but they all satisfy the limit.

The actual SAR of this mobile phone while operating can be well below that indicated above. This is due to automatic changes to the power level of the device to ensure it only uses the minimum required to reach the network. Therefore in general, the closer you are to a base station, the lower the power output of the device.

This mobile phone can be used in positions other than against your ear. This mobile phone satisfies the international guidelines when used with a carrying case or a wearable accessory approved by NTT DOCOMO, INC.** In case you are not using the approved accessory, please use a product that does not contain any metals, and one that positions the mobile phone at least 1.5 cm away from your body.

The World Health Organization has stated that "a large number of studies have been performed over the last two decades to assess whether mobile phones pose a potential health risk. To date, no adverse health effects have been established as being caused by mobile phone use."

Please refer to the WHO website if you would like more detailed information.

http://www.who.int/docstore/peh-emf/publications/facts_press/fact_english.htm

Please refer to the websites listed below if you would like more detailed information regarding SAR.

Ministry of Internal Affairs and Communications Website:

<http://www.tele.soumu.go.jp/e/sys/ele/index.htm>

Association of Radio Industries and Businesses Website:

<http://www.arib-emf.org/index02.html> (In Japanese only)

NTT DOCOMO, INC. Website:

<http://www.nttdocomo.co.jp/english/product/sar/>

Panasonic Mobile Communications Co., Ltd. Website:

<http://panasonic.jp/mobile/> (In Japanese only)

- * Technical regulations are defined by the Ministerial Ordinance Related to Radio Law (Article 14-2 of Radio Equipment Regulations).
- ** Regarding the method of measuring SAR when using mobile phones in positions other than against the ear, international standards (IEC62209-2) were set in March of 2010. On the other hand, technical regulation is currently being deliberated on by national council. (As of October, 2011)

European RF Exposure Information

This mobile phone complies with the EU requirements for exposure to radio waves.

Your mobile phone is a radio transceiver, designed and manufactured not to exceed the SAR* limits for exposure to radio-frequency (RF) energy, which SAR* value, when tested for compliance against the standard was 1.170 W/kg. While there may be differences between the SAR* levels of various phones and at various positions, they all meet*** the EU requirements for RF exposure.**

- * The exposure standard for mobile phones employs a unit of measurement known as the Specific Absorption Rate, or SAR.
- ** The SAR limit for mobile phones used by the public is 2.0 watts/kilogram (W/kg) averaged over ten grams of tissue, recommended by The Council of the European Union. The limit incorporates a substantial margin of safety to give additional protection for the public and to account for any variations in measurements.
- *** Tests for SAR have been conducted using standard operating positions with the phone transmitting at its highest certified power level in all tested frequency bands. Although the SAR is determined at the highest certified power level, the actual SAR level of the phone while operating can be well below the maximum value. This is because the phone is designed to operate at multiple power levels so as to use only the power required to reach the network. In general, the closer you are to a base station antenna, the lower the power output.

Declaration of Conformity

CE 0168

The product "P-01D" is declared to conform with the essential requirements of European Union Directive 1999/5/EC Radio and Telecommunications Terminal Equipment Directive 3.1(a), 3.1(b) and 3.2. The Declaration of Conformity can be found on <http://panasonic.net/pmc/support/index.html>.

Concerning European Economic Area: The use of Wi-Fi is restricted to only indoor use in France.

FCC Notice

- This device complies with part 15 of the FCC Rules. Operation is subject to the following two conditions:
 1. This device may not cause harmful interference, and
 2. This device must accept any interference received, including interference that may cause undesired operation.
- Changes or modifications not expressly approved by the manufacturer responsible for compliance could void the user's authority to operate the equipment.

FCC RF Exposure Information

This model phone meets the U.S. government's requirements for exposure to radio waves.

Your wireless phone contains a radio transmitter and receiver. Your phone is designed and manufactured not to exceed the emission limits for exposure to radio frequency (RF) energy set by the Federal Communications Commission of the U.S.

Government. These limits are part of comprehensive guidelines and establish permitted levels of RF energy for the general population. The guidelines are based on standards that were developed by independent scientific organizations through periodic and thorough evaluation of scientific studies.

The exposure standard for wireless mobile phones employs a unit of measurement known as the Specific Absorption Rate (SAR).

The SAR limit set by the FCC is 1.6 W/kg.* Tests for SAR are conducted using standard operating positions accepted by the FCC with the phone transmitting at its highest certified power level in all tested frequency bands. Although the SAR is determined at the highest certified power level, the actual SAR level of the phone while operating can be well below the maximum value. This is because the phone is designed to operate at multiple power levels so as to use only the power required to reach the network. In general, the closer you are to a wireless base station antenna, the lower the output.

Before a phone model is available for sale to the public, it must be tested and certified to the FCC that it does not exceed the limit established by the U.S. government-adopted requirement for safe exposure. The tests are performed in various positions and locations (for example, at the ear and worn on the body) as required by FCC for each model. The highest SAR value for this model phone as reported to the FCC when tested for use at the ear is 0.975 W/kg, and when worn on the body in a holster or carry case, is 0.873 W/kg. (Body-worn measurements differ among phone models, depending upon available accessories and FCC requirements). While there may be differences between the SAR levels of various phones and at various positions, they all meet the U.S. government requirement.

The FCC has granted an Equipment Authorization for this model phone with all reported SAR levels evaluated as in compliance with the FCC RF exposure guidelines. SAR information on this

model phone is on file with the FCC and can be found under the Display Grant section at <http://www.fcc.gov/oet/ea/fccid/> after search on FCC ID UCE211044A.

For body worn operation, this phone has been tested and meets the FCC RF exposure guidelines when used with an accessory designated for this product or when used with an accessory that contains no metal and that positions the handset a minimum of 1.0 cm from the body.

- * In the United States, the SAR limit for wireless mobile phones used by the public is 1.6 watts/kg (W/kg) averaged over one gram of tissue. SAR values may vary depending upon national reporting requirements and the network band.

Important Safety Information

Aircraft

Switch off your mobile phone when boarding an aircraft or whenever you are instructed to do so by airline staff. If your mobile phone offers a 'flight mode' or similar feature consult airline staff as to whether it can be used on board.

Driving

Full attention should be given to driving at all times and local laws and regulations restricting the use of mobile phones while driving must be observed.

Hospitals

Mobile phones should be switched off wherever you are requested to do so in hospitals, clinics or health care facilities. These requests are designed to prevent possible interference with sensitive medical equipment.

Petrol Stations

Obey all posted signs with respect to the use of mobile phones or other radio equipment in locations with flammable material and chemicals. Switch off your mobile phone whenever you are instructed to do so by authorized staff.

Interference

Care must be taken when using the mobile phone in close proximity to personal medical devices, such as pacemakers and hearing aids.

Pacemakers

Pacemaker manufacturers recommend that a minimum separation of 22 cm be maintained between a mobile phone and a pacemaker to avoid potential interference with the pacemaker. To achieve this use the mobile phone on the opposite ear to your pacemaker and do not carry it in a breast pocket.

Hearing Aids

Some mobile phones may interfere with some hearing aids. In the event of such interference, you may want to consult your hearing aid manufacturer to discuss alternatives.

Other Medical Devices

Please consult your physician and the device manufacturer to determine if operation of your mobile phone may interfere with the operation of your medical device.

Accessories

With your mobile phone, use the battery pack and AC adapter cable specified by NTT DOCOMO, INC. Otherwise, fire, burns, injury or electric shock may result.

Batteries

Do not dispose of battery packs with ordinary waste. The battery pack may catch fire or damage the environment. After insulating the battery terminal with tape, take the unneeded battery pack to a docomo Shop, or follow the instructions of local authorities in charge of collecting used batteries.

Export Administration Regulations

This product and its accessories might be covered by the Japan Export Administration Regulations (“Foreign Exchange and Foreign Trade Law” and its related laws). In addition, U.S. Re-export Regulations (Export Administration Regulations) are applied to this product and its accessories. To export and re-export this product and its accessories, take the required measures on your responsibility and at your expenses. For details on the procedures, contact the Ministry of Economy, Trade and Industry or the U.S. Department of Commerce.

Intellectual Property Right

Copyright and Portrait Right

- The contents you have obtained by capturing with the camera of this product or by downloading from websites on the Internet, or those preinstalled in this product, such as text, images, videos, music and software, are protected by the copyright law. Therefore, you have no right to copy, modify, transmit to the public, divert or distribute the copyrighted contents without permission of the copyright holder, except when the copy or quote is for personal use that is allowed under the copyright law.

Note that it may be prohibited to capture or record some live shows, performances or exhibitions even for personal use. Refrain from taking portraits of other people using this product without their consent, and from publishing shot portraits of other people by uploading to websites, etc. without their consent, as these may constitute infringements of portrait rights.

- Do not copy, modify, separate from hardware, disassemble, decompile or reverse engineer the whole or part of the software installed in this product without permission of the copyright holder, and do not have any third party do the same, nor utilize any consequences of such deeds.

Trademarks



- "FOMA", "i-mode", "i-appli", "Deco-mail", "ToruCa", "mopera", "mopera U", "WORLD CALL", "WORLD WING" and "sp-mode" are trademarks or registered trademarks of NTT DOCOMO, INC.
- "Catch Phone (Call waiting service)" is a registered trademark of Nippon Telegraph and Telephone Corporation.
- Rovi, G-GUIDE, G-GUIDE MOBILE and G-Guide related logos are trademarks or registered trademarks of Rovi Corporation and/or its subsidiaries in Japan.
- microSDHC Logo is a trademark of SD-3C, LLC.
- QR code is a registered trademark of Denso Wave Inc.



- The Bluetooth word mark and logos are owned by the Bluetooth SIG, INC. and any use of such marks by NTT DOCOMO, INC. is under license. Other trademarks and trade names are those of their respective owners.
- Wi-Fi® is a registered mark of the Wi-Fi Alliance.
- Google is a trademark of Google Inc.
- mixi and mixi logo are registered trademarks of mixi, Inc.
- "GREE" and the "GREE" logo are trademarks or registered trademarks of Gree, Inc. in Japan and/or other countries.
- Other company and product names described in the text are trademarks or registered trademarks of their respective companies.

Others

- Contains Adobe® Flash® Player by Adobe Systems Incorporated.  **ADOBE®
FLASH® PLAYER**
Adobe Flash Player Copyright © 1996-2011 Adobe Systems Incorporated. All rights reserved. Adobe and Flash are either registered trademarks or trademarks of Adobe Systems Incorporated in the United States and/or other countries.
- MPEG Layer-3 audio coding technology licensed from Fraunhofer IIS and Thomson.
- This product is licensed under the MPEG-4 patent portfolio license and AVC patent portfolio license for the personal use of a consumer or other uses in which it does not receive remuneration to
 - (i) encode video in compliance with the MPEG-4 Visual Standard and AVC Standard ("MPEG-4/AVC Video") and/or
 - (ii) decode MPEG-4/AVC Video that was encoded by a consumer engaged in a personal activity and/or was obtained from a video provider licensed to provide MPEG-4/AVC Video. No license is granted or shall be implied for any other use. Additional information may be obtained from MPEG LA, L.L.C. See <http://www.mpegla.com>.
- This product is manufactured or sold under license from InterDigital Technology Corporation.

- This product contains software licensed complying with GNU General Public License (GPL), GNU Lesser General Public License (LGPL), etc. The program is free software; you can copy it and/or redistribute it and/or modify it under the terms of the GPL or LGPL as published by the Free Software Foundation. For how to obtain the source code, visit the website below:
<http://panasonic.jp/mobile/gpl/english.html>
 Please note that we cannot respond to any inquiries regarding the source code. You cannot download the source code from a mobile phone. Use your PC to download the source code. For more details on the relevant software (including license information of GPL/LGPL), follow these steps: Home Screen  ► [Setting] ► [About phone] ► [Legal information].
- This product contains software developed by Apache Software Foundation. For more details on the relevant software (including license information), follow these steps: Home Screen  ► [Setting] ► [About phone] ► [Legal information].

Adobe® Flash® Player End User License Agreement

This Product contains the following Software (the “Software”) which has been provided by Adobe Systems Incorporated or Adobe Systems Software Ireland Limited (“Adobe”) and owned by Adobe or its licensors.

- Adobe Flash® Player

By using all or any portion of the Software, you accept all the terms and conditions of this agreement, including, in particular, the provisions set forth below as subsections (a) to (f).

Upon acceptance, this agreement is enforceable by the provider of this Product (“Provider”) and/or Adobe and/or its licensors against you and any entity that obtained the Software and on whose behalf it is used.

If you do not agree, do not Use the Software.

(a) You shall not distribute or copy the Software.

(b) You shall not modify, adapt, translate or create derivative works based upon the Software.

(c) You shall not reverse engineer, decompile, disassemble, or otherwise attempt to discover the source code of the Software.

(d) THE SOFTWARE IS PROVIDED "AS IS" WITHOUT WARRANTY OF ANY KIND, EXPRESS OR IMPLIED, INCLUDING BUT NOT LIMITED TO THE WARRANTIES OF MERCHANTABILITY, FITNESS FOR A PARTICULAR PURPOSE AND NONINFRINGEMENT OF THIRD PARTY RIGHTS. IN NO EVENT WILL PROVIDER OR ADOBE OR ITS LICENSORS BE LIABLE TO YOU FOR ANY DAMAGES, CLAIMS OR COSTS WHATSOEVER INCLUDING ANY CONSEQUENTIAL, INDIRECT, INCIDENTAL DAMAGES, OR ANY LOST PROFITS OR LOST SAVINGS, EVEN IF PROVIDER OR ADOBE OR ITS LICENSORS REPRESENTATIVE HAS BEEN ADVISED OF THE POSSIBILITY OF SUCH LOSS, DAMAGES, OR CLAIMS. THE FOREGOING LIMITATIONS AND EXCLUSIONS APPLY TO THE EXTENT PERMITTED BY APPLICABLE LAW IN YOUR JURISDICTION. AGGREGATE LIABILITY UNDER OR IN CONNECTION WITH THIS AGREEMENT SHALL BE LIMITED TO THE AMOUNT PAID FOR THE PRODUCT BY YOU, IF ANY.

(e) The ability to access content from a given source may depend on obtaining and installing an updated version of the Software.

(f) The certificate used to establish a chain of trust ("Certificate") may be revoked and ability to access content from a given source may depend on obtaining and installing an updated version of the Software containing a new Certificate.

Index

A

About phone.	143
Access point.	84
Access point	
Reset to default.	85
Setting.	84
Accessibility.	141
Accounts & Sync.	135
Alarm.	211
Android keyboard.	53
Android Market.	186
Application screen.	71
Applications.	71 , 134
Area Mail.	154
Audible touch tones.	122
Auto-rotate screen.	124
Available services overseas.	225

B

Barcode Reader.	218
Battery pack.	39
Battery pack	
Charging time.	262
Installation/removal.	39
Operating life.	41
Usable time.	262
BeeTV.	72
Bluetooth communication.	167
Book Store 2Dfacto.	72
Bookmarks.	162
Books & Comics E★eburista.	76
Brightness.	124
Browser.	159

C

Calculator.	216
Calendar.	213
Call Forwarding Service.	109

Call log.	99
Call settings.	120
Call Waiting Service.	111
Caller ID Notification Service.	113
Camera.	175
Camera	
Display shooting screen.	176
Shoot a still image.	179
Shoot a video.	179
Catalyst Reader.	220
Character entry.	53
Character entry	
Copy/cut/paste.	58
Enter pictograms.	56
Charging.	41
Clear Learning Dictionary.	62
Clock.	211
Customizing Fit Key.	63

D

Date & time.	142
Display.	124
docomo Disaster Message Board Service.	72
docomo market.	188
docomo Overseas Use.	75
Double-tap.	46
Downloads.	75
Drag.	47

E

Early warning "Area Mail".	154
ECONAVI.	217
Email.	148
Emergency call.	93
Evernote.	72

F

Facebook.	72
Flick.	46
Future Plus.	189

G

G-Guide EPG.	73
Gallery.	181
Gmail.	151
Google Maps.	197
Google Talk.	156
GREE for P.	73
Gurunavi.	75

H

Home screen.	67
Home Switcher.	76

I

i-channel.	73
Icons.	49
In-call volume.	98
Infrared communication.	164
Initial setting.	80
International call.	96
International roaming.	224

J

Japanese User Dictionary.	61
-----------------------------------	----

K

Koe no Takuhaibin.	76
----------------------------	----

L

Language & keyboard.	139
Latitude.	198
List of applications.	72
Location & security.	125

M

Make a call.	93
Map appli.	77
McDonald's Launcher.	76
melodycall.	76
Message (SMS).	145
microSD card.	37
microSD card	
Available space.	138

Erase SD card.	138
Installation/removal.	37
mixi.	73
Mobage.	73
mopera U.	85
Music player.	183
My Details.	104
My docomo appli.	73

N

Navigation.	198
NAVITIME.	73
Network security code.	128
Network services.	107
News & Weather.	209
Notification icons.	49
Notification panel.	52
Notification ringtone.	122
Notify/withhold caller ID (186/184).	95

P

Phone ringtone.	122
Phone ringtone	
Mute temporarily.	97
Phonebook.	100
Phonebook backup.	77
Phonebook	
Add a contact.	100
Check contacts.	101
Import/export.	102
PhoneBookCopy.	105
PIN unblocking key (PUK).	129
PIN1 code/PIN2 code.	128
Pinch.	47
Places.	197
Playing a video.	181
Power on/off.	44
Privacy.	137
Psmart.	73
Public mode (power OFF).	113
Push signals.	95

Q

QWERTY keypad. 53

R

Rakuten auction. 78

Rakuten gateway. 78

Receive a call. 96

Reset. 137

S

Safe mode. 238

Screen locking PIN/password. 127

Screen timeout. 124

Scroll. 47

SD backup. 222

Search. 70

Security codes. 127

Security mode appli. 74

Set up screen lock. 132

Set up SIM card lock. 129

Settings. 115

Shooting a still image. 179

Shooting a video. 179

Shortcuts. 68

Silent mode. 97

Sleep mode. 44

Software Update. 248

Sound. 122

sp-mode. 85

sp-mode mail. 144

Specifications. 262

Status icons. 50

Still image display. 181

Storage. 138

Switch vertical/horizontal display modes. 47

T

Tap. 46

Task Viewer. 75

Ten-key keypad. 53

Terminal password. 128

Terminal password setting.	133
The Mainichi Daily News.	78
ToruCa.	207
Touch and hold.	46
Touch panel.	46
Twitter.	74

U

UIM.	35
UIM	
Installation/removal.	35
Security codes.	36
Unknown sources.	134
Unlock lock screen.	45
USB connection.	173

V

Vibrate.	122
VirusScan (docomo security scan).	74
Voice Dialer.	104
Voice input & output.	140
Voice Mail Service.	107
Voice Search.	76
Volume.	98 , 122
VPN.	171

W

Wallpaper.	69
Weather news touch.	74
Wi-Fi.	89
Wireless & networks.	116
WORLD CALL.	96
WORLD WING.	224

Y

YouTube.	208
------------------	-----

Numerals

1Seg.	199
1Seg	
1Seg watching screen.	201
Channel setting.	204

TV link. 205

Access the following for checking or changing the contents of your contract, applying for respective services, or asking for related documents:

My docomo (<http://www.mydocomo.com/>) ▶ 各種お申込・お手続き (Respective applications/procedures) (in Japanese only)

- You will need your “docomo ID/password” to access the site.
- If you do not have or you have forgotten your “docomo ID/password”, contact “General Inquiries” listed on the back page of this manual.
- You may not be able to access the site depending on the details of your subscription.
- You may not be able to access the site due to system maintenance, etc.

Use your mobile phone with good manners!

When using this mobile phone, don't forget to show common courtesy and consideration for others around you.

In the following cases, turn off the power.

■ Where use is prohibited

Be sure to turn off your mobile phone in airplanes and hospitals.

* Turn off your mobile phone in hospital lobbies and waiting rooms as well as in hospital wards, because electronic medical equipment may be in use.

■ Where you may be near to people with implanted cardiac pacemakers or implanted defibrillators, such as in crowded trains

The mobile phone may adversely affect implanted cardiac pacemakers or implanted defibrillators.

In the following cases, set Public mode.

■ While driving

Using a mobile phone in your hand while driving is subject to punishment. This does not apply in unavoidable circumstances such as helping someone who is sick or injured, or maintaining public safety.

■ In theaters, movie theaters, art museums, and similar venues

Using your mobile phone in public places where quietness is the norm annoys people around you.

Use your mobile phone only in appropriate places and keep your voice and ringtone down.

■ Keep your voice down in quiet places such as restaurants and hotel lobbies.

■ When using your mobile phone in the street, make sure you do not disturb traffic.

Respect privacy.



Please be considerate of the privacy of individuals around you when shooting and sending photos using camera-equipped mobile phones.

Functions for maintaining good manners in public places

This mobile phone is equipped with useful functions for not answering incoming calls or muting the sound.

● Public mode (power OFF) (☞ page 113)

Guidance is played telling the caller that you cannot answer calls as you are currently in a place where the power should be turned off, and the call is disconnected.

● Vibration (☞ page 122)

Your mobile phone vibrates when receiving a call.

● Silent mode (☞ page 97)

Sounds emitted from your mobile phone, such as phone ringtone and audible touch tones are muted.

* Shutter sound is not muted.

You can also use optional services such as Voice Mail Service (☞ page 107) and Call Forwarding Service (☞ page 109).

General Inquiries <docomo Information Center>

 **0120-005-250** (toll free)

* Service available in English, Portuguese, Chinese, Spanish, and Korean.

* Unavailable from part of IP phones.

Business hours: 9:00 a.m. to 8:00 p.m.

■ **From DOCOMO mobile phones** (in Japanese only)

 **(No prefix) 151** (toll free)

* Unavailable from land-line phones, etc.

■ **From land-line phones** (in Japanese only)

 **0120-800-000** (toll free)

* Unavailable from part of IP phones.

Business hours: 9:00 a.m. to 8:00 p.m. (open all year round)

● Please confirm the phone number before you dial.

● For Applications or Repairs and After-Sales Service, please contact the above-mentioned information center or the docomo Shop, etc. near you on the NTT DOCOMO website.

NTT DOCOMO website <http://www.nttdocomo.co.jp/english/>

Repairs

■ **From DOCOMO mobile phones** (in Japanese only)

 **(No prefix) 113** (toll free)

* Unavailable from land-line phones, etc.

■ **From land-line phones** (in Japanese only)

 **0120-800-000** (toll free)

* Unavailable from part of IP phones.

Business hours: 24 hours (open all year round)

Loss or theft of mobile phone or payment of cumulative cost overseas <docomo Information Center>

(available 24 hours)

■ **From DOCOMO mobile phones**

International call access code for the country you stay at -81-3-6832-6600* (toll free)

* You are charged a call fee to Japan when calling from a land-line phone, etc.

※ If you use P-01D, you should dial the number +81-3-6832-6600. (To enter "+", touch and hold [0].)

■ **From land-line phones <Universal number>**

Universal number international prefix -8000120-0151*

* You might be charged a domestic call fee according to the call rate for the country you stay at.

※ For international call access codes for major countries and universal number international prefix, refer to the DOCOMO International Services website.

● If you lose your mobile phone or have it stolen, immediately take the steps necessary for suspending the use of the mobile phone.

● If the mobile phone you purchased is damaged, bring your mobile phone to a repair counter specified by DOCOMO after returning to Japan.

Failures encountered overseas <Network Support and Operation Center>

(available 24 hours)

■ **From DOCOMO mobile phones**

International call access code for the country you stay at -81-3-6718-1414* (toll free)

* You are charged a call fee to Japan when calling from a land-line phone, etc.

※ If you use P-01D, you should dial the number +81-3-6718-1414. (To enter "+", touch and hold [0].)

■ **From land-line phones <Universal number>**

Universal number international prefix -8005931-8600*

* You might be charged a domestic call fee according to the call rate for the country you stay at.

※ For international call access codes for major countries and universal number international prefix, refer to the DOCOMO International Services website.



Use your mobile phone with good manners!

When using your mobile phone in a public place, don't forget to show common courtesy and consideration for others around you.

Sales: NTT DOCOMO, INC.

Manufacturer: Panasonic Mobile Communications Co., Ltd.



Li-ion 00

To prevent damage to the environment, bring used battery packs to a docomo service counter, a docomo agent or a recycle center.

October '11 (Edition 1.1)

3TR100406AAA

F1011-1