



P-05C

INSTRUCTION MANUAL '11.7

docomo **PRIME** series

Thank you for selecting the “docomo PRIME series P-05C”.
Read this manual before use to correctly operate your P-05C.

About manual of P-05C



The operating procedures for the P-05C are also published as in “**使いかたガイド (Guide)**” on-screen manual installed onto your FOMA terminal, and “**Instruction Manual (Detailed Version)**” as a PDF. (In Japanese only)

◆“**Instruction Manual**” (this manual)◆

Description of the displayed content and operating procedures for basic functions

◆“**使いかたガイド (Guide)**” (installed onto your FOMA terminal)◆

Description of the outline and operations of frequently used functions

From the P-05C  **便利ツール (Tool)**  **使いかたガイド (Guide)**
※ This function is available in Japanese mode only.

◆“**Instruction Manual (Detailed Version)**” (PDF)◆

From a PC, download detailed information about all the functions and the operating procedures. (In Japanese only)
<http://www.nttdocomo.co.jp/support/trouble/manual/download/index.html>

※Note that the URL and published contents may be modified without notice.

Basic Package

- P-05C Handset
(With Warranty and LUMIX Phone Panel P50)



- Battery Pack P20



- Instruction Manual
(Japanese version)

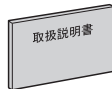

- See page 101 for optional items that support this FOMA terminal.

For Using This Manual

- Note that “P-05C” is referred to as “FOMA terminal” in this manual.
- Most operating procedures and displays in this manual are shown with the default settings of the “WHITE” handset. Further, displays and illustrations shown in this manual are for reference. The actual ones might differ.
- Operating procedures and displays in this manual are mainly explained using key operations. For the functions that can be controlled with both key and touch operations, key operations are preferentially explained in this manual. See page 29 for the instructions on using the touch panel.



Contents

FOMA Terminal	2	Precautions.....	6
What You can Do with P-05C.....	3	Handling Precautions	14
Part Names and Functions	4		

Before Using	19
Screen Explanation	24
Character Entry	33

Sound/Screen Setting	35
Lock/Security.....	40

Call Telephone	45
Mail.....	53

Phonebook	58
-----------------	----

i-mode/Full Browser.....	60
i-Channel.....	63

Map/GPS	64
---------------	----

Camera.....	67
1Seg	71
Music.....	75

i-appli/i-Widget.....	77
i-motion/Movie	79

Osaifu-Keitai	80
i-concier	81

Convenient Tools	82
Data Management	89

Support	94
Appendix.....	102

Index	116
-------------	-----

Introduction

▶ P.1 ~

Basic Operation

▶ P.19 ~

Connect

▶ P.45 ~

Search

▶ P.60 ~

Enjoy

▶ P.67 ~

More Convenient

▶ P.80 ~

Others

▶ P.94 ~

FOMA Terminal

- P-05C supports W-CDMA-GSM/GPRS-Wireless LAN system.
- Because the FOMA terminal uses radio waves, you cannot use it in places where the radio waves do not reach, where they are weak even outdoors, such as inside tunnels, basements, or buildings, or out-of-service area. You might not be able to operate the FOMA terminal even when you are in a place with a fine view such as in a high-rise building or apartment. Note that you may experience interruption of calls even if the three antennas respond to a strong radio wave, and you remain without moving to use the FOMA terminal.
- Since the FOMA terminal uses radio waves as the medium of telecommunication, calls may be tapped by a third party. However, the W-CDMA-GSM/GPRS system automatically supports tapping prevention, so your conversation will be incomprehensible to the third party, because it is recognized as mere noise.
- The FOMA terminals change your voice into digital signals and send them to the other party. In places where the radio waves are weak, the digital signals may not be converted correctly, and in such a case, the voice may sound different from the actual one.
- The user hereby agrees that the user shall be solely responsible for the result of the use of SSL/TLS. Neither DOCOMO nor the certifiers as listed herein make any representation and warranty as for the security in the use of SSL/TLS. In the event that the user shall sustain damage or loss due to the use of SSL/TLS, neither DOCOMO nor the certifiers shall be responsible for any such damage or loss.
Certifiers: VeriSign Japan K.K., Cybertrust Japan Co., Ltd.,
GlobalSign K.K., RSA Security Japan Ltd.,
SECOM Trust Systems Co., Ltd., Comodo CA Ltd.,
Entrust, Inc., and Go Daddy, Inc.
- This FOMA terminal supports FOMA Plus-Area and FOMA High-Speed Area.

- You are advised that you make separate notes of information (such as Phonebook entries, schedule events, memos, record messages, voice memos) stored in the FOMA terminal and keep them in a safe place. Note that we cannot be held responsible for the unlikely event of loss of the stored content due to a malfunction, repair, change of your model, or other mishandling of the FOMA terminal.
- You are advised to save your important data on the microSD card. If you have a personal computer, you can transfer and save data such as Phonebook entries, mail messages, schedule events, and others on the personal computer by using DOCOMO keitai datalink.
- The instructions given in this manual are for operating the FOMA terminal when the DOCOMO's UIM is used.

Unlocking SIM

This FOMA terminal supports SIM unlock. When the SIM is unlocked, other operator company's SIM cards can be used with your FOMA terminal.

- Contact your nearest docomo Shop for unlocking SIM.
- You are charged separately a charge for unlocking SIM.
- If other operator company's SIM is used, restrictions may be applied to some of the services or the functions. Note that NTT DOCOMO, INC. cannot provide any guarantees for operating the FOMA terminal when using other company's card.
- For further details on the SIM unlock, refer to the DOCOMO website.



Koe-no-Takuhaibin ▶ P.46

This service enables to keep voice messages and notify the recipient by SMS of a message reception. When the recipient plays back the message, the sender is also notified by SMS. You can store and play messages as easily as making a phone call.

使いかたガイド (Guide) ▶ P.32

You can check “使いかたガイド (Guide)” on screen for how to operate a function you want. Even when you do not have the printed “Instruction Manual” at hand, you can easily operate your FOMA terminal by referring to it.

※This function is available in Japanese mode only.

i-concier ▶ P.81

i-concier works to serve you with a pleasant life just like a clerk or concierge does. The service holds your data (area information about your neighborhood, Memo, Schedule, ToruCa, Phonebook, etc.) and sends you information, with good timing, about a variety of things according to the contents of your memo and your schedule event, your living area, your current location, or your preference or taste.

※i-concier is available in Japanese only.

eco Mode ▶ P.39

This function allows you to reduce battery consumption by adjusting the brightness of the display. eco Mode can also be turned on according to the amount of remaining battery power.

■ECO NAVI ▶ P.40

ECO NAVI is a function that identifies waste and conserves energy. A notification icon will be displayed when the eco Mode is automatically set, or when the FOMA terminal has not been operated for a certain period of time and 1Seg has terminated.

Picture Jump ▶ P.69

Shot pictures, such as still images can be attached to an i-mode mail or posted on PicMate of Panasonic picture sharing site, mixi, and so on by operating the touch panel. By using Wi-Fi function, you can transfer the file to your personal computer for backup.

Wi-Fi ▶ P.85

You can access the Internet from your home or a public wireless access point. The FOMA terminal can be a device used as the access point to connect with the compatible Wi-Fi devices.

High-image-quality Camera ▶ P.67

The high-image-quality camera with 13,200,000 pixels is equipped with the optical image stabilizer. You can shoot still images clearly in a dark place and record stabilized moving picture of Full HD.

DIGA/DLNA Link ▶ P.87

You can use Client mode to display a still image shot with P-05C using external device or to play back a TV program recorded with DIGA device.

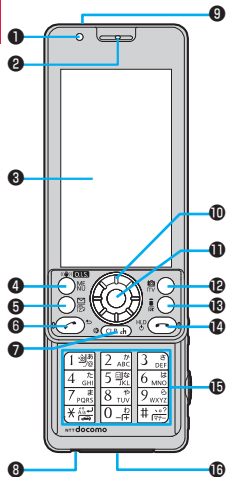

※When you open or close the FOMA terminal, ensure that you take hold of it with both hands and slide the display upward or downward. Be careful not to touch keys then. Otherwise erroneous operation of the keys might result.

- 1** Light sensor
For sensing brightness (Do not cover it with your hands or do not put a sticker on it. Doing so might disable detecting the brightness.)
- 2** Earpiece
For listening to the other party's voice
- 3** Display/Touch panel
- 4** Menu key
For showing the Main Menu
- 5** Mail key
For showing the Mail Menu
- 6** Start key
For starting to talk
- 7** CLR Clear key/i-Channel key
- 8** Microphone
For speaking to the other party
- 9** Infrared data port
For using infrared communication and the infrared remote control
- 10** Speed selector
For operating functions and menus
- 11** Call/Charging indicator
Lights while you are receiving a call or message, talking, or charging.
- 12** Camera key/1 Seg key

- 13** i-mode key/i-appli key
- 14** Power/End key
For turning on/off the power or ending a call
- 15** Numeric keys
For entering phone numbers and text
- 16** Connector terminal
Integrated terminal for connecting earphone or for charging, etc.

For using earphone

Connect an optional connector-terminal-compatible earphone. When using a connector-terminal-non-compatible earphone, use an optional plug adapter for connection.

Example for connecting the Stereo Earphone Set 01 (option) to external connector terminal

This mobile phone serves as the port where both the AC Adapter (charging) and Stereo Earphone Set 01 (Earphone/microphone terminal) are plugged in.

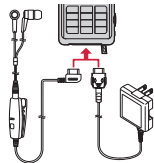

Stereo Earphone Set 01 AC Adapter

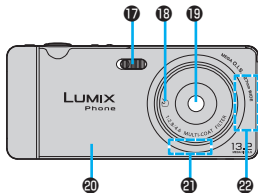

17 Flash

18 ↷ mark

An IC card is installed. Use it for Osaifu-Keitai or iC communications.

19 Camera

For shooting portraits and/or landscapes

20 LUMIX Phone panel

Remove this when attaching/removing the battery pack, UIM, and microSD card. Do not peel off the sticker on the rear surface of the LUMIX Phone panel. If you peel it off, IC card may not be written and read.

21 GPS antenna*

22 FOMA antenna*

23 1Seg antenna

For receiving 1Seg broadcasting

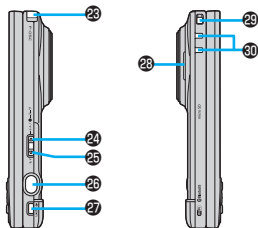

24 ▲ Side ▲ key

For turning up the earpiece volume during a call

25 ▼ Side ▼ key

For turning down the earpiece volume during a call

26 [Shutter] Shutter key

For shooting a subject by the camera

27 [Multi] Multi key

For showing the Task menu

28 Speaker

29 Strap hole

30 Charging terminal

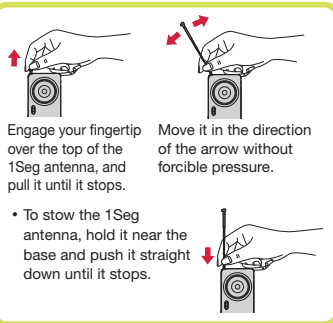



※The antenna is embedded in the handset. Covering the area near the antenna with your hand may adversely affect the quality of the communication.



Precautions

ALWAYS FOLLOW THESE DIRECTIONS

- Before using the FOMA terminal, read these safety precautions carefully so that you can use it correctly. After reading the precautions, keep them in a safe place.
- Be sure to observe these safety precautions to prevent you or those around you from inflicting injury and to avoid unnecessary damage to the property.
- The symbols below indicate the levels of danger or damage that can be caused if the particular precautions are not observed and equipments are not used properly.

	Danger	This symbol indicates that incorrect handling will almost certainly cause death or serious injury.
	Warning	This symbol indicates that incorrect handling poses a risk of causing death or serious injury.
	Caution	This symbol indicates that incorrect handling poses a risk of causing a slight injury or damage to the product or property.

- The following symbols show specific directions:

	Denotes actions prohibited to do.
Don't	
	Denotes not to disassemble the units.
Do not disassemble	



Not wet hands

Denotes not to touch with wet hands.



Avoid Water

Denotes not to use where the equipment may get wet, and avoid get it wet.



Do

Denotes mandatory instructions (matters that must be complied with).



Pull the power plug out

Denotes to pull the power plug out of an outlet.

- “Precautions” are divided into the following six sections:

General precautions for FOMA terminal, batteries, adapters, and UIM.....	P:7
Precautions for FOMA terminal	P:8
Precautions for batteries	P:10
Precautions for adapters	P:11
Precautions for UIM.....	P:12
Notes on using near electronic medical equipment	P:12

General precautions for FOMA terminal, batteries, adapters, and UIM



Danger



Don't

Do not use, store, or leave the mobile phone or its accessories in places with a high temperature (such as near fire, near heating appliances, inside a kotatsu or near other furniture with heating elements, in places exposed to direct sunlight, or in cars heated by the sun). Fire, burns, or injury may result.



Don't

Do not place the FOMA terminal or its accessories inside cooking appliances such as microwave ovens or high-pressure containers. Fire, burns, injury or electric shock may result.



Do not disassemble

Do not attempt to disassemble or remodel the FOMA terminal or its accessories. Fire, burns, injury or electric shock may result.



Avoid Water

Do not allow the FOMA terminal or its accessories to get wet either from water, drinking water or pet urine, etc. Fire, burns, injury or electric shock may result.



Do

With your FOMA terminal, use the batteries and adapters specified by NTT DOCOMO, INC. Fire, burns, injury or electric shock may result.



Warning



Don't

Do not throw the FOMA terminal or accessories, or subject them to severe shocks. Fire, burns, injury or electric shock may result.



Don't

Do not allow electrically conductive foreign objects (such as metal pieces or pencil leads) to come into contact with the FOMA terminal's charging terminal or connector terminal. Do not allow such objects to enter into the FOMA terminal. Fire, burns, injury or electric shock may result.



Don't

Do not cover or wrap the FOMA terminal or its accessories with a cushion, etc. while it is being used or recharged. Fire or burns may result.



Do

Before entering a gas station or other places where flammable gases are generated, be absolutely sure to turn off the FOMA terminal and stop charging if it is being charged. Otherwise, the flammable gases may ignite. Use the Osafu-Keitai with the FOMA terminal turned off when you are near a gas station. (When IC Card Lock is set, release the lock, and then turn off the power.)



Do

If odor, overheat, discoloration, or deformation is detected during use, battery charge, or storage, immediately follow the instructions below:

- Pull the power plug out of the outlet or cigarette lighter socket.
- Turn off the power of the FOMA terminal.
- Remove the battery pack from the FOMA terminal.

Fire, burns, injury or electric shock may result.



Caution



Don't

Do not place the FOMA terminal or accessories on unstable locations such as wobbly tables or slanted locations. They may fall off and cause injury.



Don't

Do not store in humid or dusty places, or in high temperature environments. Fire, burns or electric shock may result.



Do

If the FOMA terminal and its accessories are used by a child, a guardian should explain how to operate them correctly. During use, a guardian should also check that they are being used as instructed. Otherwise, injury may result.



Keep out of the reach of babies and infants.

Do

Take special care when you use the FOMA terminal for a long time with the adapter connected.

Do

If you use the i-appli programs, talk on the videophone, watch 1Seg programs and so on for a prolonged period of time while charging, the temperature of the FOMA terminal, battery pack or adapter may rise. If you keep direct contact with high-temperature parts, redness, itching, a rash or low-temperature skin burns may result depending on the state of your physical condition or constitution.

Precautions for FOMA terminal



Warning



Do not directly point the infrared data port at someone's eyes during transmission.

Don't

Doing so may harm the person's eyes.



While using infrared communication, do not point the FOMA terminal's infrared data port at a home electrical appliance which is equipped with an infrared device.

Don't

The infrared device may malfunction, and possibly cause an accident.



Do not light the flash close to eyes. It is particularly important that you hold the mobile phone at a distance of at least one meter away from babies and infants when shooting them.

Don't

Light the flash close to eyes may damage eyesight. Also, accidents such as injury might occur if someone is startled or dazzled by the light.



Do not allow liquids such as water, or foreign materials such as metal pieces or flammable materials to get into the UIM or microSD card slot of the FOMA terminal.

Don't

Fire, burns, injury or electric shock may result.



Do not turn on the flash toward car drivers.

Don't

It disturbs driving, and accidents may result.



Turn off the FOMA terminal in places where use is prohibited such as in airplanes and hospitals.

Do

Otherwise, the electronic devices and electronic medical equipment in those places may be adversely affected. If the Auto power ON function is set, deactivate the setting, then turn off the power. For use inside medical facilities, make sure that you comply with their regulations.

Engaging in any prohibited acts such as using the FOMA terminal in an airplane is punishable by law. However, it may be possible to use a mobile phone in an airplane, such as by setting radio wave emission to off. Comply with the instructions given by the airline company.



Do

When talking in Hands-free mode or when a ring tone is sounding, be absolutely sure to keep the FOMA terminal away from your ear. Further, when you play games or play back music with the earphone/microphone etc. connected, adjust the sound volume to moderate volume.

The excessive sound volume impairs your hearing.

Further, accidents may result due to the hardness of hearing of surrounding sound.



For those with weak heart conditions, the vibrator and ring volume must be adjusted carefully. Otherwise, the functions may adversely affect your heart.



If you are using an electronic medical device or other type of device, check with its manufacturer or vendor as to whether it will be affected by the signals from the FOMA terminal. The FOMA terminal may adversely affect the device.



Turn off the FOMA terminal when near electronic devices using high-precision control or weak signals.

The FOMA terminal may cause the electronic devices to malfunction and have other adverse effects.
※ Electronic devices that may be affected:

Hearing aids, implanted cardiac pacemakers, implanted defibrillators, other electronic medical equipment, fire alarms, automatic doors and other automatically controlled devices. If you use an implanted cardiac pacemaker, implanted defibrillator or any other electronic medical equipment, consult the manufacturer or retailer of the device for advice regarding possible effects from the radio waves.



If the display part or camera lens is broken, be careful about broken glasses or the exposed interior of the FOMA terminal.

A film is coated on the surface of the display area and the plastic panel is used for the surface of the camera lens, making it hard for the glass to break into pieces. However, if you touch the damaged or exposed parts by mistake, you may injure yourself.



Caution



Do not swing around the FOMA terminal by its strap, antenna or other parts.



You may hit yourself or others, possibly causing injury or other accidents.



Do not use the FOMA terminal if it has been damaged.



Fire, burns, injury or electric shock may result.



When using the motion sensor, ensure that you check around you for safety, securely take hold of your FOMA terminal, and do not swing more than necessitated.



Otherwise, injury or other accidents may result.



Don't

The surface of the display is coated by a film that prevents the surface from damage to ensure your safety when you accidentally drop or give shock to your FOMA terminal (for preventing the reinforced glass from scattering). Do not forcibly peel off or give damage to the film. If the display is damaged while you operate the FOMA terminal with the film peeled off, you might suffer an injury.



Don't

If you accidentally damage the display part and the substance inside leaks out, keep your face, hands and skin away from it. Otherwise, you may impair your eyesight or damage your skin. If this substance should get into your eyes or mouth, immediately rinse them with clean water, and then seek medical attention. If it should adhere to your skin or clothing, immediately wipe it off with alcohol or similar liquid, and then rinse the affected area with soap and water.



Do

Before using the FOMA terminal inside a car, check with its manufacturer or dealer whether the signals from the FOMA terminal will have any adverse effects.

In some vehicle models, the signals may adversely affect the electronic devices inside the vehicle. Such cases are rare. However, if this happens, stop using the FOMA terminal immediately.



Do

Itching, rash or eczema may be caused depending on your physical conditions or predisposition. If an abnormality occurs, stop using the FOMA terminal immediately, and then seek medical attention.

See "List of materials used" on page 13 for material of each part.



Do

Be careful not to get your finger or a strap caught in the parts when you close or open the FOMA terminal.

Otherwise, injury or other accidents may result.



Do

View the display in a sufficiently light place keeping a certain distance from your eyes.

Otherwise, your eyesight may become impaired.

Precautions for batteries

- Check the description on the label of the battery pack for the type of battery.

Description	Type
Li-ion 00	Lithium-ion battery



Danger



Don't

Do not let any metal object such as a wire come in contact with the battery terminals. Also do not carry or store the battery together with any metal objects like a necklace.

Otherwise, the battery pack may ignite, burst or overheat and its electrolyte may leak.



Don't

When installing the battery in the FOMA terminal, check that it is facing the right way, and if the battery cannot be installed easily, do not force it into place.

Otherwise, the battery pack may ignite, burst or overheat and its electrolyte may leak.



Don't

Do not throw the battery into fire. Otherwise, the battery pack may ignite, burst or overheat and its electrolyte may leak.



Don't

Do not pierce it with nails, hit it with a hammer, or step on it.

Otherwise, the battery pack may ignite, burst or overheat and its electrolyte may leak.



Do

If the battery fluid or other material gets into your eyes, do not rub them. Flush your eyes with clean water and seek medical attention immediately.

Otherwise, the loss of eyesight may result.



Warning



Don't

Never use the FOMA terminal if it has damages such as deformities or scratches as a result of dropping it.

Otherwise, the battery pack may ignite, burst or overheat and its electrolyte may leak.



Do

Immediately stop using the FOMA terminal and keep it away from fire if the battery leaks or emits an odor.

The leaked battery fluid may ignite, causing fire or burst.



Do

Be careful that your pets do not bite into the battery pack.

Otherwise, the battery pack may ignite, burst or overheat and its electrolyte may leak.



Caution



Don't

Do not dispose of the exhausted battery with other waste.

The battery may catch fire or damage the environment. After insulating the battery terminals with tape, take the unneeded battery to a handling counter such as a docomo Shop or dispose of it in accordance with local waste disposal regulations.



Don't

Do not use or attempt to charge a wet battery. Otherwise, the battery pack may ignite, burst or overheat and its electrolyte may leak.



Do

If the electrolyte fluid or other material inside the battery has leaked out, do not allow it to come into contact with the skin on your face, hands or any other part of your body.

Contact may result in loss of sight or skin problems.

If you get the fluid or other material in your eyes or mouth, or on skin or clothing, immediately wash the affected areas with clean water. If you get it in your eyes or mouth, immediately seek medical attention after rinsing.

Precautions for adapters



Warning



Don't

Do not use the adapter if its cord has been damaged.

Fire, burns or electric shock may result.



Don't

Do not use the AC adapter and desktop holder in humid places such as a bathroom.

Fire, burns or electric shock may result.



Don't

The DC adapter is for use only in a negative (-) grounded vehicle. Do not use it in a positive (+) grounded vehicle.

Fire, burns or electric shock may result.



Don't

If a thunderstorm is nearby, do not touch the adapter.

Otherwise, you may receive an electric shock.



Don't

Never short-circuit the charging terminal when the adapter is plugged into the power outlet or cigarette lighter socket. Also, never touch the charging terminal with fingers or other bare skin.

Fire, burns or electric shock may result.



Don't

Do not place heavy objects on the adapter cord.

Fire, burns or electric shock may result.



Don't

When plugging the AC adapter into the power outlet, or when unplugging it from the outlet, do not allow metal straps or other metal objects to come in contact with it.

Fire, burns or electric shock may result.



Not wet hands

Do not touch the adapter cord or power outlet with wet hands.

Fire, burns or electric shock may result.



Do

Use the adapter at the specified V AC.

When charging the FOMA terminal overseas, use the AC adapter available for use overseas to charge the FOMA terminal.

Supplying the wrong voltage to the AC adapter may result in a fire, burns or electric shocks.

AC adapter: 100 V AC

DC adapter: 12/24 V DC

[For negative (-) grounded vehicles only]

AC adapter available for use overseas: 100 V to 240 V AC

[Connect only to household AC outlet]



Do

If a fuse of the DC adapter has blown, replace it with a specified fuse.

Fire, burns or electric shock may result.

For the specified fuse, refer to each instruction manual.



Do

Keep the power plugs dust-free.

Fire, burns or electric shock may result.



Do

When plugging the AC adapter into the power outlet, plug it in securely.

Fire, burns or electric shock may result.



Do

When unplugging the power plug from the power outlet or cigarette lighter socket, do not yank the adapter cord, but take hold of the adapter to unplug it.

Fire, burns or electric shock may result.



Pull the power plug out

When you do not intend to use the adapter for a long period of time, disconnect the power plug from the power outlet or cigarette lighter socket.

Fire, burns or electric shock may result.



Pull the power plug out

If liquids such as water get in the adapter, unplug the power cord immediately from the outlet or cigarette lighter socket.

Fire, burns or electric shock may result.



Pull the power plug out

Before cleaning, pull the power plug out of the outlet or cigarette lighter socket.

Fire, burns or electric shock may result.

Precautions for UIM



Caution



Do

Be careful not to touch the cut surface of the UIM when removing it.

Otherwise, injury may result.

Notes on using near electronic medical equipment

- The description below meets "Guidelines on the Use of Radio-communication Equipment such as Cellular Telephones – Safeguards for Electronic Medical Equipment" by the Electromagnetic Compatibility Conference Japan.



Warning



Do

Comply with the following in hospitals or health care facilities:

- Do not carry the FOMA terminal into operating rooms, intensive care units (ICU) or coronary care units (CCU).
- Turn off the FOMA terminal in hospital wards.
- If there is any electronic medical equipment near you, turn off the FOMA terminal even when in a location such as a lobby.
- Comply with any regulations of hospital and health care facilities instructing you not to use or carry in a mobile phone.
- If the Auto power ON function is set, deactivate the setting, then turn off the power.



Do

Turn off the FOMA terminal in trains during the rush hour or other crowded areas as there may be someone near you with an implanted cardiac pacemaker or implanted defibrillator.

The FOMA terminal's signals may adversely affect the operation of implanted cardiac pacemakers and implanted defibrillators.



Do

If you use an implanted cardiac pacemaker or implanted defibrillator, use the FOMA terminal 22 cm or more away from an implanted cardiac pacemaker or implanted defibrillator.

The FOMA terminal's signals may adversely affect the operation of implanted cardiac pacemakers and implanted defibrillators.



Do

Patients using electronic medical equipment other than implanted cardiac pacemakers or implanted defibrillators (outside medical establishments for treatment at home, etc.) should check the influence of radio waves upon the equipment by consulting its manufacturer.

The FOMA terminal's signals may adversely affect the operation of electronic medical equipment.

■ List of materials used

Where it is used		Material/Finishing
Outer casing	Display surface	PC/UV coating
	Battery surface	ABS
	Numeric key side surface, Display side surface, Speed selector surface	ABS/UV coating
	Cap (Slide surface), Sheet area (Slide surface)	PET
	Metal part (Slide surface)	Magnesium
Connector terminal		Stainless steel/ nickel plating + tin plating
Connector terminal cover		PC, Elastomer/UV coating
Camera lens area		PMMA/surface hard coating + AR coating + water-repellent coating
Side ▲ key, Side ▼ key, Multi key		ABS/UV coating
Sheet (Battery compartment)		PC
Charging terminal		Beryllium copper/ nickel plating + gold plating
Speed selector, Start key, Clear key/ i-Channel key, Power/End key		PC/UV coating
Infrared data port area, Flash area		PMMA
Numeric key surface	Key area	PC/UV coating
	Sheet area	PET, Acrylic urethane
Display panel		Glass, PET/surface hard coating

Where it is used		Material/Finishing
Battery stopper (Inside LUMIX Phone panel), Lock claw for LUMIX Phone panel		POM
Battery terminal	Resin part	PPS
	Terminal area	Beryllium copper/ nickel plating + gold plating
Battery pack	Resin area	PC
	Label	PET
	Terminal area	Glass epoxy substrate/ nickel plating + gold plating
UIM slot surface		ABS
Screw (Inside LUMIX Phone panel), Screw (Holder area for 1Seg antenna inside LUMIX Phone panel)		Steel/nickel plating
Menu key, Mail key, Camera key/1Seg key, i-mode key/i-appli key, Shutter key, Call/Charging indicator		PC/aluminum vapor deposition + UV coating
Label (Battery compartment)		Polyester
Label (Battery surface)		PP

	Where it is used	Material/Finishing
LUMIX Phone panel	Body	ABS/aluminum foil + UV coating
	Camera ring area (Inside)	Aluminum/alumite treatment
	Camera ring area (Middle)	Acrylic urethane
	Camera ring area (Outside) ^{※1}	PC/UV coating
	Camera ring area (Outside) ^{※2}	PC/tin vapor deposition + UV coating
	Connector terminal side	ABS/UV coating
	Projection part of connector terminal side	PC/aluminum vapor deposition + UV coating
	Sheet of battery compartment surface (large/small)	PET
	Label	PP
1Seg antenna	Tip resin part	PC/UV coating
	Metal part (Pipe area), Hinge area at bottom part (Pin)	Stainless steel
	Metal part (Wire area)	Nickel-titanium alloy
	Hinge area at bottom part (Wire connection area)	Stainless steel/tin-cobalt plating
	Hinge area at bottom part (Lift up area)	Brass/tin-cobalt plating
	Holder area	Zinc alloy/nickel plating
	Compartment	POM
microSD card slot (inside LUMIX Phone panel)	Resin part	LCP
	Metal part	Stainless steel/nickel plating

• Materials may vary in some areas depending on the body color.

※1 Body color "WHITE" "MAGENTA"

※2 Body color "BLACK"

Handling Precautions

General notes

■ Do not wet the equipment.

The FOMA terminal, battery, adapter, and UIM are not waterproofed. Do not use them in environments, which are high in humidity such as in bathrooms, and do not allow them to get wet from rain. Furthermore, if carrying them against your body, they become moist due to perspiration and the internal parts may become corroded, causing malfunction. If the parts are found to have been damaged due to exposure to the liquids, any repairs will not be covered by warranty, or repairs may not be possible. This may be repaired at a cost if repairs are possible.

■ Use a dry soft cloth such as the one for cleaning glasses to clean the equipment.

- The display may be scratched if it is rubbed hard with a dry cloth.
- Stains may result from droplets of water or dirt if they are left on the display.
- Do not use alcohol, thinner, benzene, detergent or other solvents for cleaning, otherwise the printing may be removed or discoloration may result.

■ Occasionally clean the terminals of the equipment using a dry cotton swab, etc.

The soiled terminals deteriorate the connection and might cause power discontinuity or incomplete charging. Wipe the terminals with a cotton swab, etc.

Take care not to damage the terminals when cleaning them.

■ Do not place the FOMA terminal near an air conditioner outlets.

Condensation may form due to rapid changes in temperature, and this may corrode internal parts and cause malfunction.

■ Do not apply excessive force onto the FOMA terminal and battery pack.

If you put the FOMA terminal in a bag along with many other articles or sit with the FOMA terminal in a clothes pocket, the display, internal circuitry and the battery pack could be damaged or malfunction. Also, if an external device is left connected to the connector terminal (earphone/microphone terminal), the connector could be damaged, or malfunction.

- Do not rub or scratch the display part with metals. Doing so might cause damage to the part, resulting in trouble or malfunction.
- Carefully read each instruction manual attached to battery pack, adapter, or desktop holder.

Notes on handling the FOMA terminal

- Never forcibly press the surface of the touch panel, or operate it with something having a sharp point like a claw, ballpoint pen, or pin. Damage to the touch panel might result.
- Avoid using in extremely high or low temperatures. The FOMA terminal should be used within a temperature range of 5° C to 35° C and a humidity range of 45% to 85%.
- If the FOMA terminal is operated near a land-line phone, television set, radio or other devices in use, it may adversely affect the devices. Operate the FOMA terminal as far away from these devices as possible.
- It is recommended that you make separate notes of the information stored in the FOMA terminal and keep such notes in a safe place. We take no responsibility for any loss of the stored data items.
- Do not drop the FOMA terminal or subject it to strong impacts. Malfunction or damage may result.
- Do not insert an external device to the connector terminal (earphone/microphone terminal) at a slant when connecting, and do not pull it out when it is inserted. Malfunction or damage may result.
- Make sure that nothing, such as a strap, gets caught between the parts of the FOMA terminal when you close it. Otherwise, malfunction or damage may result.
- The FOMA terminal becomes warm during use or charging but this is not an abnormality. Use the FOMA terminal as it is.
- Do not leave the camera in places exposed to direct sunlight. Pixels may be discolored or burns may result.

- When using the FOMA terminal, ensure that you shut the cover for the connector terminal. Dust or water might enter into the FOMA terminal, causing malfunction.
- Do not use the FOMA terminal with the LUMIX Phone panel left removed. The battery pack might come out, or malfunction or damage may result.
- Do not apply an excessively thick sticker onto the surfaces of the keys. Otherwise, malfunctioning, damage or problems with operation may result.
- Do not put a label or sticker on the back of the display. When you open or close the FOMA terminal, the upper and lower units may stuck resulting in a malfunction or damage.
- While you are using the microSD card, never take it off or turn off the power of the FOMA terminal. Data may be erased or malfunction may result.
- Do not place magnetic cards or similar objects near the FOMA terminal or between phone parts. Magnetic data on cash cards, credit cards, telephone cards and floppy disks, etc. may be deleted.
- Do not bring magnetic substances close to your FOMA terminal. Problems with operation may result if items with strong magnetic fields are brought close to the FOMA terminal.

Notes on handling batteries

- Batteries have a limited life. Though it varies depending on the usage state, you are advised to replace the battery if its usable time is extremely short even when you fully charge it. Make sure that you buy the specified battery.
- Charge the battery in a place with an appropriate ambient temperature of 5° C to 35° C.
- The usable time of the battery differs depending on the usage environment or its remaining life.
- Depending on how the battery pack is used, it might swell as its operating life becomes short, but this is not a problem.

- Note the following points when you store a battery pack:
 - Storage in a fully charged state (the state immediately after charging is completed)
 - Storage with no battery power left (the state you cannot turn on the power of the handset due to battery drain)

These may lower the battery pack's performance and shorten its operating life.

Before storing a battery, check its remaining battery level: it is recommendable, as a general rule, for the battery icon to show two bars or for its remaining battery level to be about 40%.

Notes on handling adapters

- Charge the battery in a place with an appropriate ambient temperature of 5° C to 35° C.
- Charge the battery where:
 - There is very little humidity, vibration, and dust.
 - There are no land-line phones, television sets or radios nearby.
- While you are charging, the adapter may become warm. This is not a malfunction, so you can keep on using.
- Do not use the DC adapter for charging the battery when the car engine is not running. The car battery could go flat.
- When using the power outlet having the disengaging prevention mechanism, observe the instructions given in that instruction manual.
- Do not give a strong shock. Also, do not deform the charging terminal. Malfunction may result.

Notes on handling the UIM

- Do not apply more force than is necessary when installing or removing the UIM.
- The warranty does not cover damage caused by inserting the UIM into some other types of IC card reader/writer.
- Always keep the IC portion clean.
- Use a dry soft cloth such as the one for cleaning glasses to clean the equipment.

- It is recommended that you make separate notes of the information stored on the UIM and keep such notes in a safe place. We take no responsibility for any loss of the stored data items.
- For the environmental protection, bring any unneeded UIMs to a handling counter such as a docomo Shop.
- Do not damage, carelessly touch, or short-circuit the IC. Data might be lost or malfunction may result.
- Do not drop the UIM or subject it to strong impacts. Malfunction may result.
- Do not bend the UIM or place something heavy on it. Malfunction may result.
- Into the FOMA terminal, do not insert the UIM with a label or sticker pasted. Malfunction may result.

Notes on using Bluetooth function

- The FOMA terminal supports the security function that meets the Bluetooth Specification, to secure Bluetooth communication. However, the security may not be sufficient depending on the settings. Take care of the security for communication when using the Bluetooth function.
- Note that even if any leak of data or information occurs while making connection using the Bluetooth function, we take no responsibility.
- With the FOMA terminal, you can use the following: Headset, Hands-Free, Audio, Dial-up Communication, Object Push, and Serial Port. With Audio, you might be able to use Audio Video Remote Control. (Only with the compatible Bluetooth devices)

■ Radio frequencies

The radio frequencies for the Bluetooth function of the FOMA terminal are as follows:

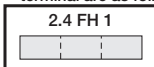

- 2.4 : Indicates radio facilities that use 2400 MHz frequencies.
- FH : Indicates modulation is the FH-SS system.
- 1 : Indicates that an estimated interference distance is 10 meters or less.
-  : Indicates that all radio frequencies 2400 MHz through 2483.5 MHz are used, and that the frequencies for mobile object identifiers shall not be avoided.

■ Cautions on Using Bluetooth Devices

Bluetooth operates at radio frequencies assigned to the in-house radio stations for mobile object identifiers that have to be licensed and are used in production lines of a factory, specific unlicensed low power radio stations, and amateur radio stations (hereafter, referred to “another radio station”) in addition to scientific, medical, industrial devices, or home electric appliances such as microwave ovens.

1. Before using this product, make sure that “another radio station” is not operating nearby.
2. If radio interference between this product and “another radio station” occurs, move immediately to another place or turn off power to avoid interference.
3. For further details, contact “docomo Information Center” on the back page of this manual.

Notes on handling Wireless LAN (WLAN)

■ **Wireless LAN** uses radio waves for exchange information, that has advantage of LAN connection in the range of radio waves. However, if you do not set security, the malicious third party might be able to intercept your communication or hack your network. It is recommended that you set security on your own decision and responsibility before using wireless LAN.

■ Wireless LAN

Do not use Wireless LAN in a place where magnetized by electric product, AV, OA equipment, etc. or where electromagnetic wave is generated.

- If magnetism or electrostatic noise affects your mobile phone, noise may be increased or communication may not be available (especially when using microwave oven, it may affect your mobile phone).
- Using near TV or radio may cause poor reception or TV screen may be disturbed.
- When multiple wireless LAN access points exist near your mobile phone and they use the same channel, search may not be performed correctly.

■ Radio frequencies

The radio frequencies for WLAN devices are written on battery pack compartment of your mobile phone. Label description are as follows:

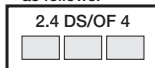

- 2.4 : Indicates radio facilities that use 2400 MHz frequencies.
- DS/OF : Indicates modulation is the DS-SS/OFDM system.
- 4 : Indicates that an estimated interference distance is 40 meters or less.
-  : Indicates that all radio frequencies 2400 MHz through 2483.5 MHz are used, and that the frequencies for mobile object identifiers shall be avoided.

To use on airplane, confirm with airline company in advance.

■ Cautions on Using 2.4 GHz Devices

The bandwidth of the WLAN devices is assigned to the in-plant radio stations for identification of mobile objects used in production lines of a factory (a license is required), specified low power radio stations (a license is not required), or amateur radio stations (a license is required), in addition to home electric appliances such as a microwave oven, industrial/scientific/medical devices.

1. Before using this device, confirm that in-plant radio stations for identification of mobile objects, specified low power radio stations or amateur radio stations are not in operation in your neighborhood.
2. If this device generates harmful radio wave interference against in-plant radio stations for identification of mobile objects, immediately change the radio frequency or stop using wireless LAN function, and contact “docomo Information Center” on the back page of this manual, then consult about treatment for prevention of the interference (for example, installation of partitions etc.).
3. If this device generates harmful radio wave interference against in-plant radio stations for identification of mobile objects or amateur radio stations, or if any trouble occurs, contact “docomo Information Center” on the back page of this manual.

Notes on handling the FeliCa reader/writer

- The FeliCa reader/writer function on the FOMA terminal uses very weak radio waves which do not require to be licensed as radio stations.
- The FeliCa reader/writer is operated on the 13.56 MHz frequencies. When you use another reader/writer nearby, take enough distance between your FOMA terminal and the reader/writer. Further, ensure that there are no radio stations that use the same frequencies.

Caution

- **Do not use the modified FOMA terminal. Using a modified FOMA terminal infringes the Radio Law.**
The FOMA terminals are granted technical regulations conformity certification as the specified radio equipment under the Radio Law and bear a “technical conformity mark ” on the nameplate as evidence of conformity. Unscrewing the FOMA terminal and modifying internal components void the technical regulations conformity certification. Do not use the FOMA terminal in this state, which infringes the Radio Law.
- **Take special care not to operate the FOMA terminal while driving.**
Holding a mobile phone in your hand while driving is subject to a fine or other penalties.
However, this does not apply in unavoidable circumstances when, for instance, responding to someone who is sick or injured or when maintaining public order.
- **Use the Bluetooth functions in Japan only.**
The Bluetooth functions on the FOMA terminal have been authorized in compliance with the radio transmission standards in Japan.
You might be imposed punishment if you use them overseas.
- **Use the Wireless LAN (WLAN) functions in Japan only.**
The Wireless LAN functions on the FOMA terminal have been authorized in compliance with the radio transmission standards in Japan.
You might be imposed punishment if you use them overseas.
- **Use the FeliCa reader/writer functions in Japan only.**
The FeliCa reader/writer functions on the FOMA terminal have been authorized in compliance with the radio transmission standards in Japan.
You might be imposed punishment if you use them overseas.

Before Using

Attaching UIM/Battery Pack

1 Remove the LUMIX Phone panel.

Close the FOMA terminal, and use both hands to slide the LUMIX Phone panel part as illustrated, in the direction of the arrow (by 2 mm or more) to unlock and remove.

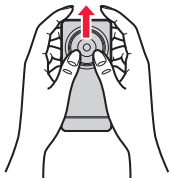

2 Insert the UIM.

With the golden IC surface downward, push the UIM slowly to the end while pressing surface.

- Take care not to damage the IC.

When you remove the UIM

Pull it out slowly while sliding.

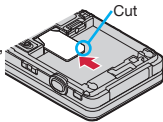

3 Attach the battery pack.

With the arrow mark facing up, fit the tab side of the battery pack to the FOMA terminal securely, and then push the battery pack in direction B while pressing it against direction A.

When you remove the battery pack

While pushing the battery stopper in direction A, lift the battery pack in direction B using the projection of it.

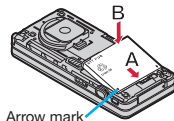

Arrow mark

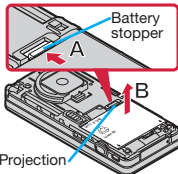

Projection

4 Attach the LUMIX Phone panel.

Open the FOMA terminal, and attach the LUMIX Phone panel to the FOMA terminal with the gap stayed open about 1 mm. Then while pushing the LUMIX Phone panel as illustrated, slide it in the direction of the arrow to install.

- Confirm there is no gap between the LUMIX Phone panel and the FOMA terminal.

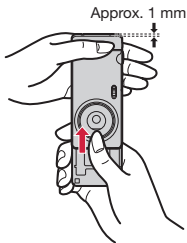

Approx. 1 mm

About UIM

The UIM is an IC card that holds your information such as phone numbers. You cannot use the FOMA terminal for communications such as voice/videophone calls, i-mode, or sending/receiving mail, unless the UIM is inserted.

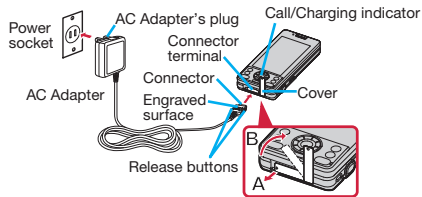

- Ensure that you turn off and take hold of the FOMA terminal when you install or remove the LUMIX Phone panel, UIM, or battery pack.
- You cannot use the UIM (blue) on your FOMA terminal. If you have that blue one, have it replaced at a docomo Shop.

Charging**Charging Using AC Adapter**

- 1 With the engraved surface of the connector of the AC Adapter (option) face up, plug the connector straight into the connector terminal until it clicks.**
 - To charge the battery, place the cover of the connector terminal as illustrated. Pull out the cover of the connector terminal to the direction A, and turn it to the direction B.
- 2 Pull out the AC Adapter's plug, and plug it into a household power socket of 100 V AC.**
- 3 When charging is completed, pull out the connector from the connector terminal while pressing the release buttons.**

Charging Using Desktop Holder

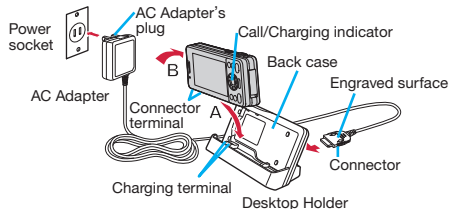

1 With the engraved surface of the connector of the AC Adapter (option) face up, plug the connector straight into the connector terminal of the desktop holder (option).

2 Pull out the AC Adapter's plug, and plug it into a household power socket of 100 V AC.

3 Hold the desktop holder with fingers, attach the FOMA terminal onto the back case (A), and then depress (B).

- Be sure to charge the FOMA terminal with the FOMA terminal closed.
- Be careful that a commercial strap is not caught between the FOMA terminal and desktop holder.

4 When charging is completed, hold the desktop holder with fingers, press down the FOMA terminal while holding the upper side of it (C), and tilt it forward to remove (D).

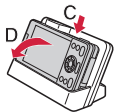

- For detaching, pull out the connector horizontally while pressing the release buttons at the both sides of the connector. Malfunction could result if you try to pull it forcibly.
- When charging starts, the Call/Charging indicator lights in red. When charging is completed, it turns off.

Turning Power ON

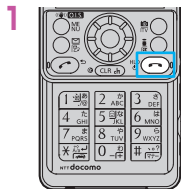

1 Press and hold  for at least one second.

After the Wake-up display is displayed, the Stand-by display appears.

To turn off the power

1. Press and hold  for at least two seconds ▶ Select "YES".
 - Depending on the display in operation, the confirmation display may not appear.

The Initial Setting display appears when any of Initial Setting items have not been set. In that case, follow on-screen instructions.



Configuring Initial Setting

The Initial Setting display appears when you turn on the power for the first time.

1 Set the date and time.

You can set the date and time. You can also correct the date and time automatically.

2 Set your Terminal Security Code.

You can set your Terminal Security Code required for setting functions.

- "0000" is set at purchase.

3 Set the size of fonts.

You can set the size of fonts on the display.

4 Set Location Request Set.

You can select whether to notify your current location for when a GPS location provision request arrives.

5 Set Keypad Sound.

You can select whether to play a keypad sound.

6 Set Speed Selector Sound.

You can set the sound for when you turn the speed selector.

Notifying Your Caller ID on the Other Party's Phone

- 1 (MENU) ▶ TEL function ▶ Dial/Receive setting ▶ Caller ID notification
- 2 Select “Activate/Deactivate”.
- 3 Select “ON”.

- If you hear the guidance requesting your caller ID, either set the Caller ID notification or add “186” first and then try calling again.

Checking Your Own Phone Number

You can check your own phone number (Own number), the model name, etc.

- 1 (MENU) ▶ Profile
 - From the display on the right, press (Edit) to store your name, mail address, etc.
 - Refer to “Mobile Phone User’s Guide [i-mode] FOMA version” for how to check or change your mail address.

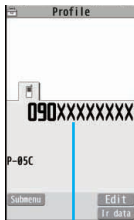

Own number

Switching to English Display

- 1 (MENU) ▶ 本体設定 (Setting)
 - ▶ 文字表示／入力 (Text display/input)
 - ▶ Select language
- 2 Select “English”.

- The “バイリンガル (Select language)” setting is saved on the UIM.

Battery level (estimate)









Full ← → Low

- When  is shown, charge the battery.
- Depending on the usage state, the battery level indication might significantly vary.

Radio waves reception level (estimate)









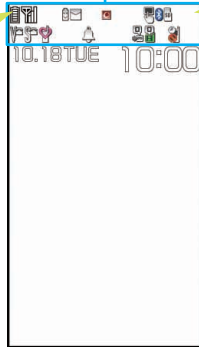

Strong ← → Weak

-  You are out of the FOMA service area or radio waves do not reach.
-  In eco Mode
-  (gray) eco Mode Autostart is set.
-  Unread i-mode mail or SMS messages exist.
-  New i-concier information exists.
-  Touch operation is available/unavailable.

Status icon









-  A Bluetooth device is connected.
-  A microSD card is inserted.
-  Vibrator is set.
-  Ring Volume is set to "Silent".
-  In Manner Mode
-  An alarm is set.
-  The number of record messages
-  The number of videophone record messages
-  Auto-key Lock is set.

Here are given descriptions of the main icons. For descriptions of other icons appearing on the display, you can get them following the procedures as shown below:









 ▶ Setting ▶ Screen/Display ▶ Icons



Notification icon

-  New i-mode mail or SMS
-  Missed call
-  Record message
-  Videophone record message
-  The mode has automatically changed to eco Mode (ECO NAVI).
-  1Seg has automatically terminated (ECO NAVI).

Desktop icon

-  i-concier
-  使いかたガイド (Guide)
-  Client mode
-  Access point mode
-  Shows the site of the URL
-  Start by voice
-  Quick search
-  Slideshow-Touch
-  Pedometer

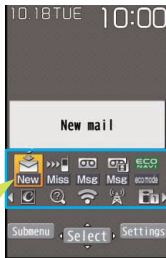
**Using Motion Control**

Motion Control enables to switch the display direction automatically by tilting the FOMA terminal.

- The major functions that support Motion Control are listed below:

- Picture Album^{※1※2}
- Music&Video Channel^{※3}
- i-motion Player^{※3}
- Movie Player^{※3}
- Playing moving picture of DIGA/DLNA Link^{※3}
- Full Browser^{※3}
- 1Seg^{※3}
- Video Player^{※3}

※1 When the mobile phone is tilted by 90 degrees to the left or right or when it is rotated by 180 degrees, the top and the bottom of the display follow the orientation of the mobile phone.

※2 When “Motion control setting” is set to “OFF”, the display appears horizontally.

※3 When the mobile phone is tilted by 90 degrees to the left, the display appears horizontally.



1  **▶ Setting ▶ Other setting**
▶ Motion control setting

2 **Select “All ON”.**

- If you tilt the FOMA terminal while a confirmation or submenu pop-up display appears, the pop-up display may be cleared.

Proceed to respective functions from icons, etc.

You can proceed to respective functions by selecting “Status icon”, “Notification icon”, “Desktop icon”, date and time.









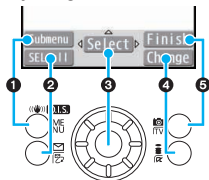











1.  ▶ Use  to highlight an icon, etc. ▶  (Select)

Navigation Displays and Key Operations

Key operations you can perform while you are operating a function are shown at the bottom of the display. (Navigation displays)

■ Key assignments and basic navigation displays



①	Operations you can perform with the  key.	 
②	Operations you can perform with the  key.	 
③	Operations you can perform with the  key.	 
	Directions in which you can scroll and select items with the  key.	   
④	Operations you can perform with the  key.	 
⑤	Operations you can perform with the  key.	 

Operating Speed Selector

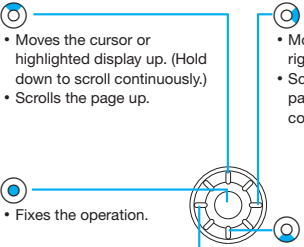
- 
- ① Moves the cursor or highlighted display up. (Hold down to scroll continuously.)
 - ② Moves the cursor to the right.
 - ③ Moves the cursor or highlighted display down. (Hold down to scroll continuously.)
 - ④ Moves the cursor to the left.
 - ⑤ Fixes the operation.
 - ⑤ Scrolls the page up.
 - ⑤ Scrolls forward page by page. (Hold down to scroll continuously.)
 - ⑤ Scrolls the page down.
 - ⑤ Scrolls back page by page. (Hold down to scroll continuously.)

Operating by Turning Speed Selector

In some displays, you can turn the speed selector to select items the same way as you press , and can move the cursor.

Turning direction

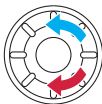

Operation example



Selecting items



Selecting pictograms, etc.



Scrolling pages

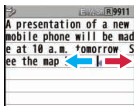

Moving the cursor

- The turning operation may not be valid depending on the function.

Menu Operation

Main Menu

Press  from the Stand-by display to show Main Menu.

- In this manual, the descriptions of operating procedures are given mainly starting with the Stand-by display.





Stand-by display





Main Menu

Menu icons

Menu icon name
In this manual, the item names shown here are described in operating procedures, etc.

Use  to highlight a menu icon and press  (**Select**). Functions categorized by the menu items are displayed. Repeat selecting items to call up the target function.

- You can press  to return to the previous display. When you press  from any display, the Stand-by display returns.
- See "Function List" for the menu items of each function. (See page 102)

Simple Menu

Simple Menu is a menu focusing on only basic functions for easy operation. By setting “シンプルメニュー (Simple menu)” using the Kisekai tool, you can show the Simple Menu by pressing  from the Stand-by display.

- Some operating procedures or items which appear on the display in Simple Menu differ from the ones described in this manual.

Submenu

When “Submenu” is displayed at the lower left of the display, you can use functions such as Store, Edit, and Delete by pressing .



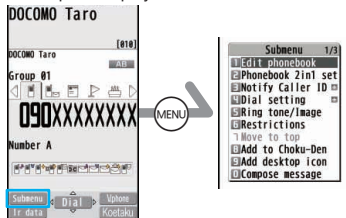











<Example> Display the submenu of a Phonebook entry



- The “” is displayed when there are further items under a particular menu item.



Functions Starting with Simple Operation

Depending on the function, you can start it either by selecting a menu item or by key operation from the Stand-by display. The following are the functions you can start by pressing keys for at least one second.

Key	Performance
	Sets/Releases Keypad Lock.
	Shows the Registration display for Phonebook entries.
	Starts 1Seg.
	Executes Check mail/message.
	Shows the Software list.
	Executes Start by voice.※
	Sets/Releases IC Card Lock.
	Sets/Releases eco Mode.
	Shows the Font setting display.
	Switches View Blind on/off.
	Activates/Deactivates Public mode (Drive mode).
	Activates/Deactivates Manner Mode.
	Starts Picture Album.
	Switches Client mode on/off.

※ This function is available in Japanese mode only.

Using Touch Panel

The touch panel can be used to perform actions such as selecting items and scrolling display. “” is displayed when the touch panel can be used, and “” is displayed when it cannot be used.





- Before use, peel off the stickers which is stuck on the touch panel at the time of purchase.

■ Notes on using Touch Panel

- The touch panel is designed to be touched lightly with a finger. Do not press the screen strongly with a finger or pointed objects such as fingernails, ballpoint pens, and pins.
- In the following cases, the touch panel may not work even if you touch it. Also, following operations may cause a malfunction.
 - Operation wearing gloves
 - Touching with a fingernail
 - Operation with foreign objects placed on the operation surface
 - Operation on the touch panel on which a protective sheet or a sticker is put

- You might not be able to operate the Touch Panel depending on the i-appli program.

Basic Touch Panel Operations

Operation	Main Operation
Touch Simply tap the touch panel. 	Select/OK <ul style="list-style-type: none">• Touch an item or control key on the touch panel.
Long touch Touch and keep your finger on the touch panel. 	Move the cursor or highlighted item on the touch panel <ul style="list-style-type: none">• Touch an item long on the list, etc.
	Continuous operation <ul style="list-style-type: none">• Touch a control key long for fast forward, etc.
Slide Touch and keep your finger on the touch panel and move it up, down, right or left. 	Scroll <ul style="list-style-type: none">• Slide an item on the list, etc.
	Display the previous or next data <ul style="list-style-type: none">• You can use the “Slide” operation to display the previous or next data/page, etc.
Quick slide Quickly slide your finger up, down, right or left and then lift it off from the touch panel. 	Scroll <ul style="list-style-type: none">• On some displays, scrolling continues for a while even after you lift your finger up. To stop scrolling, touch the panel while scrolling.
	Display the previous or next data <ul style="list-style-type: none">• You can use the “Quick slide” operation to display the previous or next data/page, etc.

Operation	Main Operation
<p>Pull apart/Pinch together Slide two fingers apart or pinch together.</p> 	<p>Magnification/Reduction</p> <ul style="list-style-type: none"> The image or display will zoom in or out.

Control key

For Speed selector operations, dial key operations, or Submenu operations, you can perform the equivalent operations by touching the control keys (long touch).

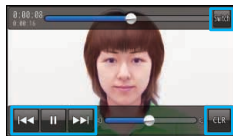

Slide lever

By adjusting the position of the slide lever, you can set the volume level, etc.



Magnification/Reduction

You can zoom in or out the pictures displayed in the Picture Album and sites displayed in the Full Browser.





- Position and type of control keys and slide levers depend on the functions.

Screen Lock

When the Power Saver Mode activates during the FOMA terminal is closed and a function that supports the touch panel is in use, Screen Lock activates and the touch panel operations are disabled.

In this way, you can prevent operations from being carried out in error while you are carrying the FOMA terminal around in a bag.

To release

- Deactivate Power Saver Mode by pressing .
 - Power Saver Mode will reactivate if you do not perform any operations for about 10 seconds.
- Slide "" to the right.
 - Screen Lock can also be deactivated by pressing and holding  for at least one second, or by opening the FOMA terminal.

Displaying Touch Menu

You can display the Touch Menu by touching the touch panel from the Stand-by display.

Home Menu

When “” is touched, the Home Menu is displayed.

On the Home Menu, you can register short-cut icons up to six and activate respective functions by touching the corresponding short-cut icon. i-Channel tickers are also shown on this menu.



Customize Menu

When “” is touched, the Customize Menu is displayed.

On the Customize Menu, you can register short-cut icons up to 27 and activate any of the functions by touching the corresponding short-cut icon.

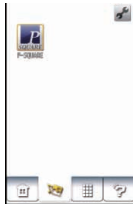

Normal Menu

When “” is touched, the Normal Menu is displayed.

You can operate any of the functions by touching the corresponding icon on this menu. The Normal Menu icons cannot be changed.



Touch Operation Guide

You can display the Touch Operation Guide by touching “”. You can check the operating methods on the touch panel.

This function is available in Japanese mode only.

Using Start by Voice

You can call up the function by voice.

This function is available in Japanese mode only.

- The first time you use this function, select “利用する (Use)” on the usage information display, or press  (開始).

1 Press and hold  for at least one second.

2 When “それではどうぞ ★★音声受付中 ★★ (Please ★★Voice is being accepted.★★)” is displayed, pronounce the function into the microphone within 10 seconds.

- When the function to be called up cannot be specified, you can look it up in “使いかたガイド (Guide)”.

- Speak as clearly as possible, in natural conversation speed.
- Speak in quiet, noise-free locations.
- Recognition result may differ depending on pronunciation and the surrounding environment.

Using Guide

You can search and check the operating methods of the functions you want to know and use. You can execute some functions from “使いかたガイド (Guide)”.

This function is available in Japanese mode only.

**1  便利ツール (Tool)
▶ 使いかたガイド (Guide)**

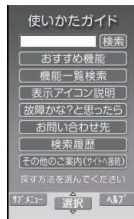

2 Enter a keyword or select a way of searching.

Highlight each item and press  (OK).
The detailed descriptions are displayed.



Character Entry



You can enter characters on the Registration display for Phonebook entries or the Composition display for mail messages, etc.

1 Select an input mode.

Press (Chrct) to select one of the input modes.



2 Enter characters.

By repeatedly pressing a numeric key, you can enter other characters assigned to the key.

<Example> When you press

Kanji/Hiragana input mode

“カ→き→ク→ク→ケ→こ”

Katakana input mode

“カ→キ→ク→ケ→コ→2”

Alphabet input mode (Uppercase)

“A→B→C→a→b→c→2”

Alphabet input mode (Lowercase)

“a→b→c→A→B→C→2”

Numeral input mode

“2”

3



Convert/fix characters.

1. Press to specify the area to be converted.
2. Press to move the cursor onto the candidate list.
3. Press to select a conversion candidate.
4. Press to fix the character.

Other key operations

(SB・SM): Enter symbols, smileys, or URLs.

(PI・PIC): Enter pictograms, Deco-mail pictograms, or Deco-mail pictures.

: Enter a line feed.
(You can switch between uppercase and lowercase or enter “” and “” by pressing this key after you enter a character.)

(for at least one second): Undo the fixed/erased characters.



: Clear text.

<Example> Entering “タダの菓子” in the text of an i-mode mail message

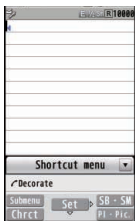

- 1   (New)
▶ Select the text field.



- 2 Enter hiragana characters in Kanji/Hiragana input mode.

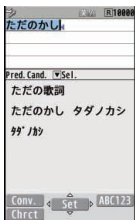

た → Press **4** once and  once.
だ → Press **4** once and  once.
の → Press **5** five times.
か → Press **2** once.
し → Press **3** twice.





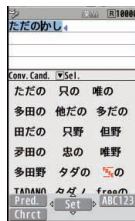

- When a character on the same key comes after a character such as “あ” and “し”, press  to move the cursor, and enter the next character.
- You can press  to select one of the prediction conversion candidates while you are entering the characters.

- 3 Use  to move the cursor to the right of “の”.

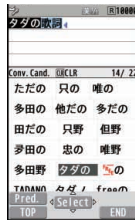

- 4 Use  to move the cursor onto the candidate list
▶ Use  to highlight “タダの” and press  (Select).





- 5 Use  to move the cursor onto the candidate list ▶ Use  to highlight “菓子” and press  (Select).

Sound/Screen Setting



Changing Ring Tone

<Example> Changing the ring tone for incoming voice calls

- 1  **Setting ▶ Sound/Vib./Manner ▶ Select ring tone**
- 2 **Select “Phone”.**
 - Press  (Play) to check the content actually played back or displayed.
 - To set a ring tone for mail messages, videophone calls, and so on, select the corresponding item.
- 3 **Select “Select ring tone”.**
- 4 **Select a type of ring tone.**
- 5 **Select a folder ▶ Select a ring tone.**

Adjusting Ring Volume

<Example> Adjusting the ring volume for incoming voice calls

- 1  **Setting ▶ Sound/Vib./Manner ▶ Ring volume**
- 2 **Select “Phone”.**
 - To adjust ring volume for mail messages, videophone calls, and so on, select the corresponding item.
- 3 **Use  to adjust the volume.**

Setting Vibrator

You can set the vibrator to notify you of incoming calls.

<Example> Setting the vibrator for incoming voice calls

- 1  **Setting ▶ Sound/Vib./Manner ▶ Vibrator setting**
- 2 **Select “Phone”.**
 - To set a vibrator for mail messages, videophone calls, and so on, select the corresponding item.
- 3 **Select a pattern.**

Using Manner Mode

With a single key press, you can set a tone from the FOMA terminal such as a ring tone, keypad sound, and alarm sound silent. When you start Manner Mode, not a sound but the vibration notifies you of incoming calls or messages.

- 1 Press and hold **#** for at least one second.



To release
Perform the same operation.



Using Original

You can use “Original” to tailor your FOMA terminal to how it works while Manner Mode is ON.

1. **MENU** ▶ **Setting** ▶ **Sound/Vib./Manner**
▶ **Manner mode setting** ▶ **Manner mode set** ▶ **Original**
2. Set each item.
3. Press **TV** (**Finish**).

- Even in Manner Mode, the shutter tone and focus lock tone of the camera, and the start/end tones of the voice recorder sound.

Setting Keypad Sound OFF

You can silence a Keypad sound for when you press a key.

1. **MENU** ▶ **Setting** ▶ **Sound/Vib./Manner**
▶ **Other sound setting** ▶ **Keypad sound**
2. Select “OFF”.



Changing Display Settings

Changing Stand-by display

1. **MENU** ▶ **Setting** ▶ **Screen/Display**
▶ **Stand-by display**
2. Select “Stand-by display”.
3. Select a type of image.
4. Select a folder ▶ Select an image.
 - You may be able to select a display format depending on the image.

Changing Display Brightness

You can adjust the brightness of the display. You can also set to automatically adjust the display brightness according to the ambient light.

- 1  **Setting** ▶ **Backlight/Illum.** ▶ **Backlight**
- 2 Select **"Brightness"** ▶ Select **"ON"**.
- 3 Press  to adjust the brightness.



Lighting off/Power Saver Mode

You can set the display brightness to OFF. You can also set the time that elapses before Power Saver Mode activates. Power Saver Mode activates when the time set for "Time to saver" has elapsed without any operations on the FOMA terminal. The display turns off to reduce battery consumption.

1.  **Setting** ▶ **Backlight/Illum.** ▶ **Backlight**
2. Select **"Lighting"**.
 - "Time to saver" setting for the FOMA terminal when closed can be set from "When slide closed".
3. Select **"OFF"** ▶ Enter the time (seconds) for "Time to saver".

Making Display Hard to See from People Around

You can set "View blind" to make it harder for the people around you to see the display from oblique angles.

- 1  Press and hold  for at least one second.
 "View blind" appears on the Stand-by display.
To release
Perform the same operation.



Changing Font Size

<Example> Changing the size of all the characters to “X-large”

- 1 Press and hold  for at least one second.
- 2 Select “Character size”.
- 3 Select “X-large”.
 - Select “Separate setting” when you want to set the character size of each function separately.



Changing Machi-chara Setting

You can change the Machi-chara image which appears to inform you of missed calls, new mail messages, new i-concier information and others.

- 1  ► **Setting** ► **Screen/Display**
► **Machi-chara setting**
- 2 Select “Display setting” ► Select “ON”
► Select a folder.
- 3 Highlight a Machi-chara image and press  (**Set**).

Using Kisekae Tool

You can set the ring tone, Stand-by display, menu icons and others at a time.

- 1  ► **Setting** ► **Screen/Display**
► **Kisekae Tool setting**
- 2 Select a folder.
- 3 Highlight a Kisekae Tool file and press  (**Set all**).
- 4 Select “YES”.
 - Some menu configurations change according to the usage frequency depending on the type of the menu.

Reset Menu Icons to Default

1.  ►  (**Submenu**) ► Reset menu screen
2. Enter your Terminal Security Code ► Select “YES”.

Changing Illumination When Receiving

<Example> Changing call illumination for voice calls

- 1  **Setting** ▶ **Backlight/Illum.**
▶ **Illumination setting**
- 2 Select **"Illumination in call"**
▶ Select **"Illumination"**.
- 3 Select **"Phone"**.
 - To set illumination such as for mail messages and videophone calls, select the corresponding menu.
- 4 Select an illumination.
 - If you select "Gradation", Color 1 to 12 light up in sequence.

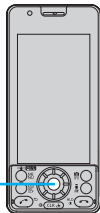

The indicator lights in the set color when a call comes in.

Switching to the eco Mode

With a single key press, you can set the eco Mode that reduces battery consumption. Changing to eco Mode affects items specified in "eco mode setting", e.g. dimming the display.

- 1 Press and hold **5** for at least one second.





Press and hold 5 for at least one second.

"" appears.

To release
Perform the same operation.

eco Mode Setting

You can set the items for reducing battery consumption for when the eco Mode activates.

- 1  **Setting** ▶ **Battery** ▶ **eco mode setting**
- 2 Put a check mark for items to be set.
- 3 Press  (**Finish**).

eco Mode Autostart



This setting ensures that the mode will be automatically set to the eco Mode when the remaining battery level has dropped to the set level or less.

“Battery level” of “eco mode autostart” is set to “40%” in default.

1  ► **Setting** ► **Battery**
► **eco mode autostart**

2 **Select “ON”.**

3 **Set each item** ►  **(Finish)**

When the “eco mode autostart” is set to “ON”,  (gray) will be displayed. When the mobile phone automatically switches to eco Mode,  will be displayed and  will be displayed on the desktop.



Lock/Security

Various Security Codes

■ Caution on security codes

- You should avoid using the numbers for security codes such as denoting your birth date, part of your phone number, local address number, room number, “1111” or “1234” that is easily decoded by a third party. Also make sure that you take a note of the security codes you have selected just in case you forget them.
- Take care not to let others know your security codes. Even if your security codes are known and used by a third party, we at DOCOMO take no responsibility in any event for the resultant loss.
- If you do not remember your respective security codes, you need to bring an identification card such as your driver’s license, the FOMA terminal and UIM to the handling counter of a docomo Shop. For details, contact “docomo Information Center” on the back page of this manual.
- The PIN unblocking key (PUK) is described on the application form (your copy) that is handed over to you at a docomo Shop at the time of contract. If your contract has been made at a shop other than a docomo Shop, you need to bring an identification card such as your driver’s license, and the UIM to the handling counter of a docomo Shop, or consult “docomo Information Center” on the back page of this manual.



Terminal Security Code “0000” at purchase

This is a four-to-eight digit number for deleting all files or changing settings. When the display for entering the Terminal Security Code appears, enter your four-to-eight digit code and press .

To change

1. ▶ Setting▶ Lock/Security▶ Change security code

Network Security Code Determining at the time of contract

This is a four-digit number required for your identification when you place an order at a docomo Shop, docomo Information Center, or “お客様サポート (User support)” site, or when you use respective network services.

- “お客様サポート (User support)” is available in Japanese only.

To change

From i-mode, you can change your Network Security Code by selecting “ Menu”→“お客様サポート (User support)”→“各種設定(確認・変更・利用) [Respective settings (Confirmation/Change/Use)]”→“ネットワーク暗証番号変更 (Change Network Security Code)”.

i-mode Password “0000” at the time of your contract

This is a four-digit number required for registering/deleting My Menu, applying for/canceling Message Services or i-mode pay services, etc.

To change

From i-mode, you can change your i-mode password by selecting “ Menu”→“English”→“Options”→“Change i-mode Password”.

PIN1 Code/PIN2 Code “0000” at the time of your contract

For the UIM, you can set two security codes, namely the PIN1 code and PIN2 code.

The PIN1 code is a four-to-eight digit number for checking the user each time the UIM is inserted into the FOMA terminal or each time the FOMA terminal is turned on, to prevent the unauthorized use by a third party.

The PIN2 code is a four-to-eight digit number for executing Reset Total Charge, using the user certificate or applying for the issue of it, etc.

When the PIN1 Code/PIN2 Code entry display appears, enter your four-to-eight digit PIN1 code/PIN2 code and press

.

- If you enter a wrong PIN1 code/PIN2 code three times in succession, the FOMA terminal locks and cannot be used.

To change

1. ▶ Setting▶ Lock/Security▶ UIM setting
2. Enter your Terminal Security Code
 - ▶ Select “Change PIN1 code” or “Change PIN2 code”.
- You need to set “PIN1 code entry set” to “ON” to change the PIN1 code in advance.

PIN Unblocking Key (PUK)

The PIN unblocking key (PUK) is the eight-digit number for releasing the blocked PIN1 code and PIN2 code.

You cannot change this code by yourself.

- If you enter a wrong PIN unblocking key (PUK) 10 times in succession, the UIM is locked. In that case contact one of docomo Shops.

PIN1 Code Entry Set



You can set the FOMA terminal not to work unless you enter your PIN1 code when turning on the power.



1.  **Setting ▶ Lock/Security ▶ UIM setting**
2. **Enter your Terminal Security Code ▶ Select “PIN1 code entry set”.**
3. **Select “ON” ▶ Enter the PIN1 code.**

To release
Select “OFF”.

Various Lock Functions

A variety of lock functions is installed on your FOMA terminal such as preventing illegal use of a third party, or protecting your private information.

Dial Lock	<p>You can set your FOMA terminal not to be used by a third party. You can do no operations other than answering calls and turning on/off the power.</p> <p>1.  Setting ▶ Lock/Security ▶ Lock ▶ Enter your Terminal Security Code ▶ Dial lock</p> <ul style="list-style-type: none"> • To release, enter your Terminal Security Code from the Stand-by display.
IC Card Lock	<p>You can lock the IC card function. You cannot use the Osaifu-Keitai, ToruCa download, iC Communication, etc.</p> <p>1. Press and hold  for at least one second.</p> <ul style="list-style-type: none"> • To release, perform the same operation and enter your Terminal Security Code.

Omakase Lock	<p>When you have lost your FOMA terminal or in other cases, you can lock your personal data (such as Phonebook entries) and the IC card function of Osaifu-Keitai by contacting DOCOMO.</p> <ul style="list-style-type: none"> For details on Omakase Lock, refer to “User’s Guide [Basic Usage]”. <p>■ Setting/Releasing Omakase Lock  0120-524-360 (In Japanese only) Business hours: 24 hours (open all year round) ※Unavailable from some IP phones.</p> <ul style="list-style-type: none"> You can set/release also from the My docomo site via your personal computer or other devices. (In Japanese only)
Original Lock	<p>You can lock functions which utilize personal information such as Phonebook entries or schedule events.</p> <p>1.  Setting ▶ Lock/Security ▶ Lock ▶ Enter your Terminal Security Code ▶ Select a level for Original Lock.</p> <ul style="list-style-type: none"> To release, select “OFF”.
Keypad Lock	<p>Keys and the touch panel operations are disabled.</p> <p>1. Press and hold  for at least one second.</p> <ul style="list-style-type: none"> To release, perform the same operation or open the FOMA terminal.

Setting Auto-key Lock

Keypad Lock can be activated when you close the FOMA terminal or the specified time elapses without any operations.

- 1  Setting ▶ Lock/Security ▶ Keypad lock
- 2 Enter your Terminal Security Code ▶ Auto-key lock
- 3 Select “Closed lock set.” or “Unoperated lock set.” ▶ Select an item.

- “Closed lock set.” is set to “ON” in default. When the FOMA terminal is closed and keypad locks, Power Saver Mode activates and the display disappears. Also, when Power Saver Mode activates with the FOMA terminal closed, display disappears and keypad locks. Pressing  will turn the display back on.

To prevent keypad from locking such as when the FOMA terminal is closed, follow the steps listed above and set “Closed lock set.” to “OFF”.

Setting Incoming Call Restriction

You can set whether to receive (accept) or not to receive (reject) incoming calls depending on the reason, such as from the parties which has not been registered in Phonebook or incoming calls from any parties who do not notify you of their phone numbers. There are three reasons for no caller ID; “User unset”, “Payphone”, and “Unknown”.

- 1  **Setting ▶ Lock/Security**
▶ **Call rejection set.**
- 2 **Enter your Terminal Security Code**
▶ **Select an item to be set.**
- 3 **Select “Accept” or “Reject”.**
 - If you select “Accept” for “User unset”, “Payphone” or “Unknown”, you can set a ring tone or call receiving display.

Resetting to Default

Resetting the Function Settings to Default

You can reset the items on “Function List”, which are indicated by . (See page 102)

- The items indicated by  might include the functions which do not return to their default settings or state.

- 1  **Setting ▶ Other setting**
▶ **Reset settings**
- 2 **Enter your Terminal Security Code**
▶ **Select “YES”.**

Deleting Stored Data at Once





You can delete all the stored files together and each function setting will return to the default.

- 1  **Setting ▶ Other setting ▶ Initialize**
- 2 **Enter your Terminal Security Code**
▶ **Select “YES”.**
- 3 **Select “YES”.**

Call Telephone

Making a Call/Videophone Call

Making a Call by Entering the Phone Number

- 1 Enter a phone number starting with a city code.
- 2 Press  to make a call.
 - Press  () to make a videophone call.
- 3 Press  to end the call.

- This FOMA terminal has no inward-facing camera. Therefore, the image sent to the other party is a Chara-den image, still image, or image being shot by the outward-facing camera.

You can put a call on hold by pressing

 during a call.

You can release held call by pressing .







Making a Call from Phonebook



<Example> Search a Phonebook entry by the name stored in Phonebook

- 1 Press .
- 2 Select “Search name”.



Enter the reading of the name from the first character.

 - You can use another search method such as “Search phone No.”, and “Search e-mail”.
- 3 Enter a part of the name 
 - If you enter nothing and press ; then you can display all Phonebook entries.
- 4 Select a Phonebook entry 

When an entry contains multiple phone numbers, press  to select a desired phone number.

 - Press  () to make a videophone call.

Making a Call with Redial/Received Calls

1 Press  (Redial) or  (Received calls).

2 Select a call record 

- Press  (Vphone) to make a videophone call.

Using Koe-no-Takuhaibin

This service keeps voice message on behalf of you.

- For details, refer to the DOCOMO website.

1 Enter a phone number.

- Koe-no-Takuhaibin message can be sent from a Phonebook entry, Redial, Dialed Calls, or Received Calls as well.

2  (Koetaku)

▶ Operate following the voice guidance.

Playing Back Messages

When Koe-no-Takuhaibin message has been received, an SMS message is given as notice of recording. Select “再生 (Play)” on the detailed display of the SMS message to play back the received message.

- You can also play back messages by following the operation below:

“ ▶ TEL function ▶ Koe-no-Takuhaibin
▶ Play messages”.

Making an International Call

You can use WORLD CALL to make an international call from Japan.

- Contact “docomo Information Center” on the back page of this manual for inquiries about details on WORLD CALL.
- When using international carriers other than DOCOMO, contact them.

1  (for at least one second)

▶ Enter numbers in order of country code

→ area code (city code)

→ destination phone number.

- You can enter “+” by pressing and holding  for at least one second.
- When the area code (city code) begins with “0”, enter the area code without “0”. However, include “0” when making a call to some countries or regions such as Italy.

2 Press 

- Press  (Vphone) to make a videophone call.

3 Select “Dial”.

- DOCOMO videophones conform to “3G-324M standardized by the international standard 3GPP”. You cannot connect to the videophone using a different format.

Receiving a Call/Videophone Call

1 A call comes in.

The ring tone sounds and the Call/Charging indicator lights.

2 Press to answer the call.

When a videophone call comes in

You can receive the videophone call the same way as with a voice call.

The substitute image is sent to the other party.

3 Press to end the call.

Adjusting Earpiece Volume

1 Press and hold for at least one second during a call.

- Press  during a videophone call.

2 Press to adjust the earpiece volume.

When You cannot Answer a Call

Activate Record Message

By activating Record Message, you can record a caller's voice/video message when you cannot answer the call.

- When a call comes in, an answer message is played back after the ring time elapses. Then, the caller's voice is recorded with audio or video.

1 ▶ TEL function

▶ Rec. msg./Voice memo





▶ Record message setting

2 Select "ON" ▶ Select "Phone".

- To activate Record Message for videophone calls, select "Videophone".

3 Select an answer message

▶ Enter a ring time (seconds).

When a voice or video message is recorded as Record Message, the notification icon like  or  appears in the Stand-by display. Select  or  icon to play either the voice or video message.



Using Public Mode (Drive Mode)

Once you activate Public mode (Drive mode), the guidance is played back telling that you cannot answer the call as you are currently driving or in a public place (such as a train, bus or movie theater) where you should refrain from speaking on the phone. Then, the call is disconnected automatically.

1



Press and hold  for at least one second.



"" appears on the Stand-by display.

To deactivate
Perform the same operation.



When a call comes in during Public mode (Drive mode), the ring tone does not sound and the record is stored in "Received calls". The alarm does not sound even when the specified alarm time comes.

Using Public Mode (Power Off)

Once you activate Public mode (Power off), when the FOMA terminal's power is OFF, the guidance is played back telling that you cannot answer the call as you are currently in a public place (such as a hospital, airplane or near a priority seat on a train) where you are required to turn off the power of the FOMA terminal. Then, the call is disconnected automatically.

1 Enter      .

2 Press .

To deactivate

1. Enter      .

2. Press .

Using Various Network Services

■ Network services available

The following are the DOCOMO network services available for the FOMA terminal.

Service	Application	Monthly fee
Voice Mail Service	Required	Charged
Turned Off or Out of Range Notification Call Service	Not required	Free
Call Waiting Service	Required	Charged
Call Forwarding Service	Required	Free
Nuisance Call Blocking Service	Not required	Free
Caller ID Notification Service	Not required	Free
Caller ID Display Request Service	Not required	Free
Dual Network Service	Required	Charged

Service	Application	Monthly fee
English Guidance	Not required	Free
Multi Number	Required	Charged
2in1	Required	Charged
Public mode (Drive mode)	Not required	Free
Public mode (Power off)	Not required	Free
OFFICEED	Required	Charged
Melody Call	Required	Charged
Koe-no-Takuhaibin	Not required	Free

- The network services are not available when you are out of the service area or out of reach of radio waves.
- “Deactivate” does not mean that the contract for Voice Mail Service, Call Forwarding Service or other services is canceled.
- For details on “OFFICEED”, refer to the DOCOMO corporate service website (in Japanese only).
<http://www.docomo.biz/html/service/officeed/>
- The outlines of the each network service in this manual are described along with the menus of the FOMA terminal. For details, refer to “Mobile Phone User’s Guide [Network Services]”.
- For subscriptions and inquiries, contact “docomo Information Center” on the back page of this manual.



Using Voice Mail Service

1 ▶ TEL function ▶ Voice mail service

To activate the service

1. Select "Activate" ▶ Select "YES".
 - You can also specify a ring time.

To play back the message

1. Select "Play messages"
 - ▶ Select "Play (voice call)" or "Play (videophone)"
 - ▶ Select "YES".
2. Operate following the voice guidance.



Using Call Waiting Service

1 ▶ TEL function ▶ Other network serv. ▶ Call waiting

To activate the service

1. Select "Activate" ▶ Select "YES".

Answer an Incoming Call during a Call

Press . Each time you press , you can switch the parties you can talk with.

Using Call Forwarding Service

1 ▶ TEL function ▶ Other network serv. ▶ Call forwarding

To activate the service

1. Select "Activate" ▶ Select "Activate" ▶ Select "YES".
 - You can set the phone number of forwarding destination or ring time as well.

Emergency Call

Emergency Calls	Phone number
Calls to police	110
Calls to fire station and ambulance	119
Calls for accidents at sea	118

- This FOMA terminal supports “Emergency Location Report”. When you make an emergency call such as at 110/119/118, information about the place where you are dialing from (location information) is automatically notified to emergency-response agencies such as police stations. It might happen that your correct location is not detected by emergency-response agencies depending on the location you dial from or radio wave conditions. When your location information is notified, the name of emergency-response agency is displayed on the Stand-by display. When you do not notify your phone number such as by adding “184” by every call, your location information and phone number are not notified. However, when an emergency-response agency has judged that the location information and phone number should be detected because of emergency priority such as for protection of human life, it might get location information and phone number regardless of your setting. Areas and timing “Emergency Location Report” introduced vary depending on the preparation of respective emergency-response agencies.
- When you make a call at 110/119/118 from the FOMA terminal, tell an operator that you are calling from a mobile phone and let them know your phone number, and then clearly tell where you are currently around, so that police/fire station can make a confirmation call to your mobile phone. In addition, stay at the current location while talking preventing the call from being disconnected. Do not turn off the power immediately, and make sure to place your phone standby for at least 10 minutes after the call.
- You might not be connected to regional police/fire station depending on the area where you are calling from.
- When using the videophone function of the FOMA terminal to place an emergency call to 110, 119 or 118, the call will automatically be made as a voice call.

Using Overseas

International Roaming (WORLD WING) is a service that allows you to use the FOMA terminal with the phone number and mail address you use in Japan, in a service area of the overseas carrier partnered with DOCOMO. It enables you to continue using the voice call, SMS and i-mode mail settings without having to make any changes.

- Concerning the areas where the service is supported: This FOMA terminal is available within the service area of 3G network and GSM/GPRS network, and in the countries/regions supporting 3G 850MHz. Check the areas where you can use the service.
- Refer to the following before you use this FOMA terminal overseas:
 - “Mobile Phone User’s Guide [International Services]”
 - DOCOMO International Services website
 - “海外ご利用ガイド (Overseas use guide)” pre-installed in “My document” in Data Box or displayed from  Map/Overseas ▶ Overseas use guide
 - ※ “海外ご利用ガイド (Overseas use guide)” is available in Japanese only.
- For the country codes, international call access codes, international prefix numbers for the universal number, and connectable countries, regions, and overseas carriers, refer to “Mobile Phone User’s Guide [International Services]” or the DOCOMO International Services website.
- A fee charged for overseas use (call fee, packet communication fee) differs from that of in Japan.



Available Service Overseas

Major Communication Service	3G	GSM/ GPRS	GSM
Voice call ^{※1}	○	○	○
Videophone call ^{※1}	○	—	—
SMS ^{※2}	○	○	○
i-mode ^{※3}	○	○	—
i-mode mail	○	○	—
i-Channel ^{※3※4}	○	○	—
i-concier ^{※5}	○	○	—
i-Widget ^{※6}	○	○	—
Packet communication by connecting with a personal computer	○	○	—
Position location of GPS ^{※7}	○	○	—

○: Available —: Not available

- ※1 When using 2in1, you cannot make calls using your B number. When using Multi Number, you cannot make calls using an additional number.
- ※2 If the destination is a FOMA terminal, enter the other party’s phone number as you do in Japan.
- ※3 You need to establish i-mode International Settings.
- ※4 You need to establish i-Channel International Settings. You are charged a packet communication fee for automatically updating the basic channel information as well (which, in Japan, is included in the i-Channel fee).
- ※5 You need to establish i-concier International Settings. You are charged a packet communication fee for each information you receive.
- ※6 You need to establish i-Widget International Settings. When you show an i-Widget display, multiple Widget Appli programs might start communication. In that case, you are charged a packet communication fee for each communication.
- ※7 No fee is charged for GPS measuring (checking current location). However, you are charged a packet communication fee for displaying maps from location information.
- Some services are not available depending on the overseas carrier or network.

Making a Call to Outside the Country You Stay in

1 (for at least one second)



▶ Enter numbers in order of country code

→ area code (city code)

→ destination phone number.

- You can enter “+” by pressing and holding  for at least one second.
- Enter “81” as a country code when you make an international call to Japan.
- When the area code (city code) begins with “0”, enter the area code without “0”. However, include “0” when making a call to some countries or regions such as Italy.



2 Press to make a call.

- Press  () to make a videophone call.

Making a Call in Country You Stay

1 Enter a phone number.

2 Press to make a call.

- Press  () to make a videophone call.

Making a Call to WORLD WING User Overseas

When you make a call to a person who is also internationally roaming, make the call the same way as to make international calls to Japan even if he/she is in the country you stay at.

Mail

Sending i-mode Mail

Once you subscribe to i-mode, you can exchange e-mail messages over the Internet. You can attach within 2 Mbytes of up to 10 files (photos, moving pictures, etc.) with body text added. For details on i-mode mail, refer to “Mobile Phone User’s Guide [i-mode] FOMA version”.

1 ▶ ()

2 Enter each item.

Enter a destination
(mail address).

Enter a subject.
Select a file such
as an image.

Enter text.
Operate Auto Deco-mail.



3 Press ().

Sending Deco-mail

You can change the color or size of characters or background color, or insert images or Deco-mail pictograms.



- You can also select "Decome-Template" to create Deco-mail.

2 Enter an address and subject.

3 Select the text field

▶ Select one of decorations from the palette ▶ Enter text

▶  (Set)

- When the text field is selected, the prediction conversion candidates appear. Press (CLR) to close the conversion candidate display, and then press  to display the palette. (In Japanese mode only)

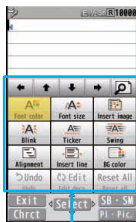

Palette

4 Press (Send).

Sending Decome-Anime

You can create impressive messages by inserting text or images into a Flash file.

1 ▶ Create new Deco-Anime

2 Enter an address and subject.

3 Select the text field

▶ Highlight a Decome-Anime template and press  (Set).

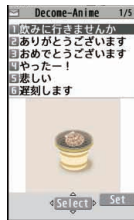



4 Edit characters and images (Finish)

5 Press (Send).

Displaying Received i-mode Mail

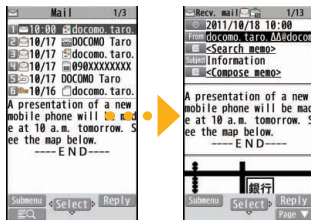

- 1  Inbox
- 2 Select a folder.
- 3 Select an i-mode mail message.





When you receive an i-mode mail message, “” appears on the upper area of the display.



Replying to i-mode Mail

- 1 Press  (Reply) while an i-mode mail is displayed.
- 2 Enter each item.
- 3 Press  (Send).

Forwarding i-mode Mail

1.  (Submenu) while an i-mode mail is displayed
▶ Reply/Forward ▶ Forward
2. Enter each item.
3. Press  (Send).

Checking New i-mode Mail

You can check the i-mode Center for a new mail message or Message R/F.

1



Press and hold  for at least one second.

When checking is completed, the following display appears.





Number of messages
Select an item to show the display for selecting a message.

Sorting i-mode Mail

You can use "Auto-sort" to sort received/sent i-mode mail messages into a folder such as "Business" or "Friend" which has been created in advance.

<Example> Sorting mail messages, which come from the address stored in the Phonebook, into a folder

- 1 Highlight a folder from Inbox Folder list and press  (Submenu)  Auto-sort
- 2 Select "Address sort".
- 3 Select "Look-up address"  Select "Phonebook".
- 4 Look up for Phonebook entries and select a target i-mode mail address.

Early Warning “Area Mail”

Receiving Area Mail

You can receive information such as about earthquake alerts that are issued from the Japan Meteorological Agency as an Area Mail message.

When an Area Mail message arrives, “

The received contents of some messages are automatically displayed. To erase the displayed content, select “OK”.

- You can receive Area Mail messages even when you are not contracted to use i-mode.

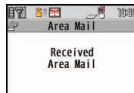

Setting Area Mail

1  ▶ Mail setting ▶ Area Mail setting

2 Select an item to be set

▶ Set each setting.

- You can also check “Check ring tone” for how your FOMA terminal works when you receive an Area Mail message.

Using SMS

You can send text messages to the mobile phone number at the other party.

Sending SMS

1  ▶ Compose new SMS

2 Enter each item.

Enter a phone number.

Enter text.



3 Press  (Send).

Displaying Received SMS Message

- 1  ► Inbox
- 2 Select a folder.
- 3 Select an SMS message.

When you receive an SMS message, “” appears on the upper area of the display.



Phonebook

Storing Phonebook Entries

Storing New Phone Numbers/Mail Addresses, etc.

You can store Phonebook entries in the FOMA terminal (Phone) or on the UIM.

- 1 Press and hold  for at least one second.
- 2 Select “Phone”.

The display for entering a name appears. Enter a name and proceed.

When storing entries onto the UIM Phonebook

Select “UIM”.

- 3 Enter each item.

Enter a name.

Enter a reading.





Enter a phone number.

Enter a mail address.



- 4 Press  (Finish).



Storing Phonebook Entries from Redial/Received Call

- 1 Press  (Redial) or  (Received calls).
- 2 Highlight a call record and press  (Submenu) ▶ Select “Add to phonebook”.
- 3 Select “Phone” ▶ Select “New”.
- 4 Enter each item.
- 5 Press  (Finish).



Stored birthdays are displayed also in your schedule. If you do not wish them to be displayed, select “Disp. in schedule” → “Not disp. in schedule” in the submenu on the birthday input display.



Editing Phonebook Entries

- 1  ▶ Search and select a Phonebook entry.
- 2  (Submenu) ▶ Edit phonebook
▶ Select an item to be edited
▶ Edit the contents.
- 3 Press  (Finish).
- 4 Select “YES”.

Deleting Phonebook Entries

- 1  ▶ Search and select a Phonebook entry.
- 2  (Submenu) ▶ Select “Delete data”.
- 3 Select “Delete this”.
- 4 Select “YES”.

Displaying i-mode Sites



i-mode is a service that enables you, by using the display of the mobile phone supporting i-mode, to use online services such as site access, Internet access, and i-mode mail.

- i-mode is a pay service that is available on a subscription basis.
- For details on i-mode, refer to “Mobile Phone User’s Guide [i-mode] FOMA version”.
- You can display SSL/TLS※-compatible pages via FOMA terminal.

※SSL/TLS are the safer data communication systems using authentication/encryption technology to protect your privacy.

1 Press .

You can access the  Menu. Repeat selecting items (links) to display the desired site.

- While you are online, “” blinks.
-  Menu is available in English. Select “English” from the display on the right.



Before using i-mode

- Content of sites or websites is in general protected by copyrights law. You can use data such as text and images for your entertainment, which you download to your mobile phone supporting i-mode, but you cannot use them, part or whole of it as is, or modify them for the purpose of sale or redistribution, without approval from copyright holders.
- If you replace the UIM with another one or turn on the power without UIM, you cannot display/play back files, such as still images/moving pictures/melodies you download from sites, attached files (still images/moving pictures/melodies and other files) sent/received by mail, Screen Memo, and Messages R/F.
- When the file has been set for the Stand-by display or for specified ring tone, of which display or playback is restricted by the UIM, the settings return to default if you replace it with new one or turn on the power without UIM.

Displaying Websites Designed for PC

You can browse Internet websites designed for PCs using the Full Browser function.

- Note that you are charged a high communication fee for the massive data communication such as browsing Internet websites having many images or downloading data. For details on the packet communication fee, refer to “Mobile Phone User’s Guide [i-mode] FOMA version”.
- You can browse Internet websites composed of frames. You can select a frame to display it as well.

1 mode/web ▶ Full Browser Home

- By default, a confirmation display appears asking whether you want to use Full Browser.

- You might not correctly display some Internet websites.
- You can use Full Browser via Wi-Fi communication. You are charged a packet communication fee to switch from Wi-Fi communication to the FOMA network. Note that the FOMA network does not return to Wi-Fi communication automatically.

Switching Browsers





You can switch to Full Browser to show the Internet websites incorrectly displayed by i-mode.

- The billing system differs between i-mode and Full Browser. With the latter, as packet communications fee will be a large sum, you are advised to use i-mode packet flat-rate service.

1 () while the website is displayed by i-mode ▶ Full Browser ▶ Switch to FB.

2 Select “YES”.

To switch from Full Browser to i-mode

1.  () while the website is displayed by Full Browser ▶  mode Browser ▶ Switch to  mode

Viewing and Operating Sites

Operations on site viewing display

Scroll display/Move highlighted/

Move the pointer: 

Select an item (link):  (Select)

Return to previous page:  (Back)

Forward to next page:  (Next)

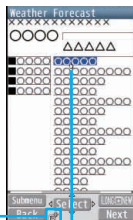

“” or “” appears while accessing by Full Browser.

Pointer

Storing Frequently Accessed Sites

Bookmark websites or i-mode sites you frequently visit to get them displayed easily.

1.  (Submenu) while the site is displayed
▶ Bookmark ▶ Add bookmark

2. Select “OK” ▶ Select a destination folder.

To access a site stored in Bookmark



1.  ▶  ▶ Bookmark
2. Select a folder ▶ Select a bookmark.

Saving Site Contents

If you save the page once you visited as a screen memo, you can easily refer to it without connecting to i-mode.

1.  (Submenu) while the site is displayed
▶ Screen Memo ▶ Save screen memo
2. Select “Phone” ▶ Select “YES”.

To display a saved screen memo

1.  ▶  ▶ Screen Memo
2. Select “Phone” or “microSD”.
3. Select a screen memo.

- Depending on the site, for instance, when saving of screen memos is disabled at the site, you may not be able to save screen memos properly.

This service distributes information such as news and weather forecast to i-Channel mobile phones. The automatically received latest information flows on the Stand-by display by tickers. You can read it on the i-Channel list by pressing **CLR**.

Further, two types of channels, "Basic channel" provided by DOCOMO and "Okonomi (Optional) channel" provided by IPs (Information Providers) are available. You are not charged a packet communication fee for auto-updates of "Basic channel" information.

You are charged a packet communication fee for auto-updates of "Okonomi (Optional) channel" information that will be available by registering your favorite channels. Note that you are charged separately a packet communication fee for browsing detailed information for both "Basic channel" and "Okonomi (Optional) channel". When you use the international roaming service, you are charged a packet communication fee for both auto-update and browsing detailed information.

- i-Channel is a pay service which is available on a subscription basis (You need to subscribe to i-mode to apply for i-Channel).
- For details on i-Channel, refer to "Mobile Phone User's Guide [i-mode] FOMA version".
- The i-Channel service is provided in Japanese only.



Displaying i-Channel

1 Press **CLR**.



Ticker

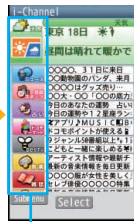

Select each channel to browse its detailed information.

※The display is for reference. The actual one may differ.

You can change font size for ticker by following the steps described below;

1. **MENU** ▶ **mode/web** ▶ **i-Channel** ▶ **Ticker display setting** ▶ **Ticker size setting**
2. Select an item.





- GPS is a function that receives radio waves from the GPS satellites and acquires location information of the FOMA terminal.
- This GPS function cannot be used as a navigation device for airplanes, vehicles or people or as a device for conducting high-accuracy survey. If it is used for these purposes or even if used for other purposes, we do not take any responsibility for a loss, such as pure economic loss resulting from the facts that you have missed the chance to check the positioning (communication) results, which have been caused by external factors such as malfunctions, erroneous operations, or power failure (including battery shortage) on the FOMA terminal.
- GPS is operated by the United States Department of Defense, so the GPS radio wave conditions might be controlled (accuracy deterioration or radio wave supply suspension, etc.) depending on the defense strategy of the United States Department of Defense. In addition, even when surveys have been conducted in the same location or environment, the radio wave status may differ depending on the positions of the satellites so that the same results may not be obtained.
- GPS uses the radio waves from satellites so note that in the environments listed below make impossible or difficult to receive radio waves, and as a result, the error in the position information may be greater than 300 meters.
 - In densely wooded areas, downtown high-rise areas, built-up residential areas
 - In a building or right under it
 - In the basement, tunnel, ground, water
 - Close to high-tension wires
 - In a car or train
 - In bad weather such as heavy rain and snow
 - In a bag or case
 - There are obstacles (persons and articles) around the FOMA terminal.
 - When you cover the displays, keys, microphone, or speakers of the FOMA terminal with your hand.
- When providing position information or notify your current location, check the information given from your GPS service provider or DOCOMO's website. In some cases, you may be charged for using these functions.
- When you are outside the service area, you cannot use the GPS function except to check your current position.
- In the following cases, you cannot use the GPS function except to provide your position.
 - During Dial Lock
 - During Keypad Lock
 - During Omakase Lock



Reading Map

You can start GPS compatible i-αppli, and you can read a map of current or specified location.

- At purchase, “地図アプリ (Map Application)” is set.

1 (MENU) ▶ Map/Overseas ▶ Map

To change GPS compatible i-αppli to be started

1. (MENU) ▶ Map/Overseas ▶ Map&GPS set./history
▶ Map setting ▶ Select Map
2. Select an i-αppli program ▶ Select “OK”.

Using Navi

You can activate a GPS compatible i-αppli to use the navigation functions.

- At purchase, “地図アプリ (Map Application)” is set.

1 (MENU) ▶ Map/Overseas ▶ Navigation

When you use a GPS compatible i-αppli, the location information is sent to the information provider of the i-αppli program you use.



Checking Current Location

You can locate your current location by GPS. You can also display a map using this location information and send this information as an i-mode mail.

- You are not charged a packet communication fee for checking your current location. However, a separate packet communication fee are charged in cases where, for instance, a map has been displayed from the location information.

1 (MENU) ▶ Map/Overseas ▶ Position/Notify ▶ Position location

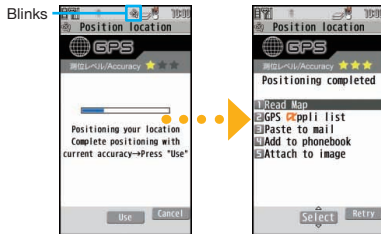

Positioning

Positioning location result

Your current position is located by GPS, and the positioning accuracy is displayed.

To display the map of the current location

1. Select “Read Map” from the Position Location Result display.
- GPS compatible i-αppli starts and shows the map.

Using AUTO-GPS



Your current location is automatically positioned, and by sending your location information periodically to your GPS service provider, you are enabled to receive a variety of services according to your location, such as weather forecast, shopping guide, or sightseeing information around.

- To use a service that supports the AUTO-GPS function, use the AUTO-GPS function compatible *i-appli* to establish the AUTO-GPS service information for respective services.
- The AUTO-GPS function enables you to automatically position your current location according to your movements, and to send your location information and pedometer information to your service provider. (Your location is positioned once every five minutes according to your movements.)
- When you start to use the AUTO-GPS function, check GPS service providers or the DOCOMO website for how you can use services. It might happen that you will be charged a fee for using them.
- You might separately be charged a packet communication fee for sending your location information.
- Note that depending on the way you use your FOMA terminal, the level of the power consumed by the FOMA terminal may be increased as a result of periodical communication.

Setting AUTO-GPS





You can set whether to use AUTO-GPS function. ("ON" is set at purchase.)

AUTO-GPS function uses your stride when determining your movements so you can set your stride as well.

- 1  **Map/Overseas**
 **Map&GPS set./history**  **AUTO-GPS**
 **AUTO-GPS setting**
- 2 Select "ON".
- 3 Enter a stride (cm).

Using Service provided by DOCOMO

Select whether you use the AUTO-GPS service that syncs with *i-concier* or respective services provided by DOCOMO.

- Set the service to "ON" to automatically and periodically send your location information from the FOMA terminal to DOCOMO.
 - To use *i-concier* or respective services, you need to separately subscribe for and establish the settings.
- 1  **Map/Overseas**
 **Map&GPS set./history**  **AUTO-GPS**
 **DOCOMO service set.**
 - 2 Select "ON" or "OFF".

Viewing and Touching Operation of Finder Display

You can use the camera to shoot still images or moving pictures. You can use the touch panel to operate the camera when shooting.

You can check the settings.

By touching, you can make the display brighter than usual.

By touching, you can display the still image or the moving picture you have shot in Picture Album.

By touching, you can display the submenu. You can change the settings.

Shows the remaining time of recordable moving pictures.

Stabilizer is set.

Shows the remaining number of recordable still images.

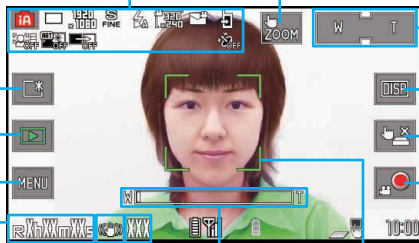

By touching, you can switch to Touch Zoom. Touch a point to be zoomed in.

You can adjust the magnification by touching W (Wide) or T (Tele).

By touching, icons or guidelines switches to display or nondisplay.

By touching, you can switch to Touch Shutter. You can shoot a still image by touching the touch panel.

By touching, you can record a moving picture.

When a subject is focused on, the frame becomes green.

The zooming status is displayed.

- Do not leave the FOMA terminal with the lens pointing to direct sunlight. Pixels may be discolored or burns may result.
- When the battery level is low, you may not be able to save still images/moving pictures you shoot.

Shooting Still Images/Moving Pictures

Shooting Still Images

1 Press  [Shutter].

2 Press  [Shutter].

The still image is automatically saved.

Shooting Moving Pictures

1 Press  [Shutter].

2 Start recording by touching “”
▶ End the recording by touching “”.

The moving picture is automatically saved.

- When you shoot a moving picture of Full HD (1920 x 1080) or HD (1280 x 720), you need Speed Class compatible microSD card.

Viewing Still Images/Moving Pictures after Shooting

You can display the still image or the moving picture you have shot in Picture Album. You can detect a person's face on the still image you have shot and expand it, or add corrective effects to the detected face. You can also play expressive slide shows with the effect function.

1 Press and hold  for at least one second.

- Picture Album is also activated by touching “” on the Finder display.

2 Touch a file.

By touching, you can open the still image and the moving picture list.

By touching, you can display the Operation Guide.

By touching, you can display the submenu.

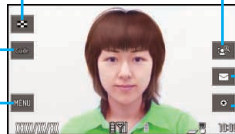

By touching, you can zoom detected face.

By touching, you can attach the displayed file to an i-mode mail message.

By touching, you can add to/remove from Favorite.

Using Picture Jump

Shot pictures, such as still images can be attached to an i-mode mail or posted on PicMate of Panasonic picture sharing site, mixi, and so on by operating the touch panel. By using Wi-Fi function, you can transfer the file to your personal computer for backup or display the file on the large-screen TV. You can set the following functions to Picture Jump.

- | | | |
|---------------|----------------|---------------|
| ·Att. to mail | ·PostPicMate | ·Post mixi |
| ·Post GREE | ·Post blog | ·Photo panel |
| ·PC backup | ·Transfer pic. | ·Display pic. |
| ·Favorite | ·Delete | ·SEL always |

- When you use Wi-Fi function, you need to connect P-05C with access point device and set in advance.

1 Touch a file long on the file list.

Function icons appear on the left, right, top and bottom of the display.

2 Slide a file onto icons.

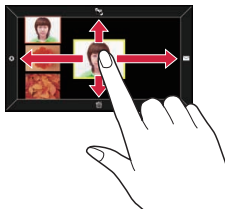

Shooting in Various Ways

Shooting Still Images Using Omakase Choice

You can shoot 8 still images one after the other. The FOMA terminal automatically displays the successfully-shot still images judging from the focus and composition.

1 [Shutter] ► MENU ► Burst Shoot ► Omakase choice

2 Select a burst shooting speed.



- The best-shot still image is enlarged.
- “” is added to three superior images.
- Slide left or right to enlarge the next or the previous image.



3 Touch a still image to be saved and then, touch “Save”.

- You can save all the still images by touching “STO all”.

Shooting Still Images Using Auto Shutter

The camera automatically shoots identifying the number of faces and detecting the distance between faces by the face detection.

<Example> Using “Group shutter” to shoot a group of three persons

1  [Shutter] ► MENU ► AutoShutter

2 Touch “Group shutter”.

3 Touch “Three”.

When the faces of three persons are detected, the self timer works, and about three seconds later an image of the group is shot.



The still image is automatically saved.

Optical Image Stabilizer (O.I.S.)

You can shoot less blurring still images and moving pictures by using optical image stabilizer. When the sensor detects hand vibration, camera unit moves to defuse the motion. This lessens deterioration of the image quality caused by hand vibration more than before.

- P-05C adopts Optical image stabilizer with movable lens system. Therefore, the center of the camera lens area might not stay in the center of the outer frame. It has no impact on performance.
- The mode is set to “Auto” at purchase.

1 Press  from the finder display.

- Each time  is pressed, the mode is switched between “OFF” and “Auto”. “” appears when the mode is set to “OFF”, “” appears when the mode is set to “Auto”.

You can shoot less blurring moving pictures while walking and checking it on the display.





Using 1Seg

■Using 1Seg

1Seg is a service provided by television entrepreneurs (broadcasting stations). You are not charged a communication fee for receiving video and audio. For about fee charged by NHK, contact NHK.

※You are charged a packet communication fee for browsing “Data broadcasting site” and “i-mode site”. You might be charged an information fee for using some sites (i-mode pay sites).

※For details on the 1Seg service, browse the following websites:

The Association for Promotion of Digital Broadcasting

From personal computer: <http://www.dpa.or.jp/english/> From i-mode: <http://www.dpa.or.jp/1seg/k/> (In Japanese only)

■Broadcasting waves

1Seg is one of the broadcasting services receiving radio waves (broadcasting waves) different from that used for the FOMA services.

Reception condition might be deteriorated or you might not be able to receive 1Seg broadcast in places as follows:

- Places far away from radio towers that transmit broadcasting waves
- Mountain-ringed regions or behind buildings
- In tunnels, underground, or recesses of buildings

To improve reception conditions, fully extend the 1Seg antenna. Also the reception conditions might be improved by changing the direction of the antenna, or by moving yourself to another place.

■Battery level

If you try to start 1Seg when the battery is low, the battery alert tone sounds, and a confirmation display appears asking whether to start it. When you do nothing on the confirmation display for about one minute, 1Seg automatically terminates.

■Messages on the display when you use 1Seg for the first time

When you use 1Seg for the first time after purchase, the Exemption Clause Confirmation display appears.

If you select “NO” on a confirmation display which appears after pressing , the same confirmation display does not appear afterward.



Setting Channels

When you activate 1Seg for the first time or change the area you are in, you need to operate “Channel setting”. Select “Auto channel setting” to enable you to search automatically for broadcast stations you can watch.

- You need to set this function with the 1Seg antenna extended when you are in a terrestrial digital TV broadcasting service area.

1 (MENU) ▶ CAMERA/TV/MUSIC ▶ 1Seg
▶ Channel setting ▶ Auto channel setting

2 Select “YES”.

3 Select “YES” ▶ Enter a title.

To execute Channel Setting by selecting an area

- (MENU) ▶ CAMERA/TV/MUSIC ▶ 1Seg ▶ Channel setting
▶ Select area
- Select an area ▶ Select a prefecture.
- Select “YES”.

Watching 1Seg

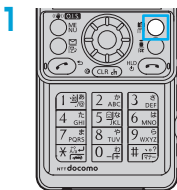

Press and hold  for at least one second.

1Seg starts and the viewer display appears.

Each time (CLR) is pressed while viewing, the mode is switched between mute and unmute.



Viewing and Operating Viewer Display

Video — Points to the video content area.

Caption — Points to the Japanese text overlay: カモメは波の音を聞いていた。

Data Broadcasting — Points to the program information area: Welcome to ○○ワンセグ, ○○ニュース, 放課後、□□□で遊ぼう, 今週の占い, おすすめ たべもの横丁.

Operation Mode — Points to the mode indicator icons:

- : Video Mode
- : Data Broadcasting Mode

Displayed while setting 1Seg Op-free Auto Off — Points to the flashing '13ch' indicator.

Channel (Remote-control number) — Points to the '13ch' indicator.

When a broadcasting station is broadcasting multiple services (programs), "Viewing service number/Number of all services" is also displayed. — Points to the '13ch/3' indicator.

Sound Volume — Points to the volume icon.

Displayed while receiving caption information — Points to the 'EPC' indicator.

Displayed while you are watching a 1Seg program — Points to the '10:00' time indicator.

Video being recorded — Points to the 'REC' indicator.

Program's name — Points to the program title 'カモメと海'.

Switch Visual Image/Caption — Points to the 'ON V. img ON Caption' indicator.

Airwave Reception Level (estimate) — Points to the signal strength indicator with a scale from Strong to Weak. A note states: "“” appears out of the broadcasting area."

The operation on the viewer display

Channel switch:

Sound volume adjustment: or





Switch TV/data BC:

Video recording: (for at least one second) or (for at least one second)

- The recorded video is saved on the microSD card.

Setting Timer Watching or Recording 1Seg

Set the date and time, a channel, and program name, and enter them to the TV Timer List or Timer Recording List. When the set time arrives, watching or recording starts.

- 1  ► CAMERA/TV/MUSIC ► 1Seg
- 2 Select “TV timer list” or “Timer recording list”.
- 3 Press  ().
- 4 Enter each item.
- 5 Press  ().

Playing Recorded Video

- 1  ► Data box ► 1Seg
- 2 Select “Video” ► Select a file.

Each time  is pressed while playing, the mode is switched between mute and unmute.



Music&Video Channel

Music&Video Channel is a service which automatically delivers up to about two-hour sound programs at night just by selecting your favorite music programs etc. in advance. Further, you can enjoy high-quality video program of up to about one-hour. Programs are updated periodically and you can enjoy the delivered programs at any time such as on commuting.

■ Before using Music&Video Channel

- Music&Video Channel is a pay service that is available on a subscription basis. (To apply for Music&Video Channel, you need to subscribe to i-mode and i-mode packet flat-rate service.)
- In addition to the service fee for using Music&Video Channel, you might be charged separately an information fee depending on the program.
- If you insert the UIM to the Music&Video Channel incompatible FOMA terminal after you subscribe to Music&Video Channel, you cannot use Music&Video Channel Service. Note that the service fee applies unless you cancel the Music&Video Channel subscription.
- You cannot set or download programs during international roaming*. Take procedures to halt the distribution of programs before going abroad. Then, after homecoming, resume the reception of distribution.
- *When you try to set or download programs during international roaming, note that you are charged a packet communication fee for i-mode communication.
- For details on Music&Video Channel, refer to "Mobile Phone User's Guide [i-mode] FOMA version".
- The Music&Video Channel service is provided in Japanese only.

Setting Programs

- 1  CAMERA/TV/MUSIC
▶ Music&Video Channel ▶ Program set.
- 2 Follow the instructions on the display to set a program.

The program automatically downloads at night.

Playing Programs

- 1  CAMERA/TV/MUSIC
▶ Music&Video Channel
- 2 Select a program.

Operation while playing back a Music&Video Channel program

Halt:  ()

Pause:  or  [Shutter]

Sound volume adjustment:  or 

Search (fast forward): Press and hold 

Search (fast rewind): Press and hold 



Downloading Chaku-uta Full® Music Files

You can download Chaku-uta Full® music files from sites.

- 1 Select a Chaku-uta Full® music file from a downloadable site.
- 2 Select “Save” ▶ Select “YES”.
- 3 Select a destination folder.

- “Chaku-uta Full” is a registered trademark of Sony Music Entertainment Inc.

■ Handling music files

You can use music files saved on the microSD card for personal use only. Before using, give enough consideration not to infringe on the third party’s intellectual property rights or other rights such as copyright.

Playing Music Files

MUSIC Player enables you to play Chaku-uta Full® music files you have downloaded from sites, or to play Windows Media® Audio (WMA) files you saved on the microSD card using your personal computer.

- 1  ▶ CAMERA/TV/MUSIC
▶ MUSIC Player
- 2 Select “All music”
▶ Select a music file.

Operations of MUSIC Player display

Halt:  ()



Pause:  () or  [Shutter]

Search (fast forward): Press and hold 

Search (fast rewind): Press and hold 

Sound volume adjustment:  or 

Replay next file:  or  (for at least one second)

Replay previous file:  or  (for at least one second)
(When playback time is over three seconds, you go back to the beginning of the file.)



i-appli is a software program for mobile phone supporting i-mode. By downloading various software programs from the i-mode site, you can use your FOMA terminal more conveniently. You can automatically update the stock price information or weather information, and enjoy games without accessing network.

i-Widget is a useful function for gaining easy access to frequently used contents and tools (Widget Appli programs) such as the calculator, clock, memo pad and stock market information. Widget Appli programs can be added by downloading them from the web site.

- Depending on the i-appli program, you might be charged a communication fee for using.
- The packet communication fee for overseas use differs from the one for domestic use.
- A multiple number of Widget Appli programs may start communicating when you open the i-Widget display. If you browse detailed information, you are charged separately a packet communication fee.
- For details on i-appli/i-Widget, refer to "Mobile Phone User's Guide [i-mode] FOMA version".



Starting i-appli

- 1 Press and hold  for at least one second.
- 2 Select a software program.



Starting Widget Appli

- 1 Press .
 - 2 Select a Widget Appli program.
- You can operate Widget Appli program separately.

Downloading i-αppli from Sites

1 Select a software program from a downloadable site.

2 Select “OK” when downloading ends.

- When the software program is storable in “Customize Menu”, the confirmation display appears asking whether to store it.

3 Select “YES”.

- You can delete the pre-installed i-αppli programs. You can re-download deleted programs from the “P-SQUARE” site. You can download not only i-αppli programs but also the pre-installed Deco-mail pictograms, Kisekae Tool files, Machi-chara images, Chara-den images, templates, dictionaries, and Content packages from the “P-SQUARE” site (in Japanese only).
☰ Menu→メニューリスト (Menu List)→ケータイ電話メーカー (Mobile Phone Maker)→P-SQUARE
- Deadlines for re-download services
 - ・“リバーシ (REVERSI)”: the end of March, 2015
 - ・“ハイパー四川省 (Hyper Sichuan)”: the end of March, 2015
 - ・“モバイルGoogleマップ (Google Map for Mobile)”: the end of May, 2014
- The re-download services may be halted or closed without notice even in the service period.

i-motion/Movie

i-motion is a file consisting from video, audio, and music which you can download to your FOMA terminal from i-motion sites that support i-motion. You can also set it for a ring tone.

Also, by using high speed communication, you can play back smooth and high-quality movie files provided by portal sites, movie specialty sites and other sites on the Internet.

- When downloading or streaming an i-motion/movie file, you might receive a bulky file. When data size required for sending or receiving is bulky, packet communications fees will be a large sum. You are advised to use i-mode packet flat-rate service.
- Two types of i-motion/movie files, streaming type and normal/download type are available.

Categories	Description
Streaming type (cannot be saved)	Plays data while receiving.
Normal/Download type (can be saved)	When download is completed, the Download Completion display appears. You can then play or save data.

Downloading i-motion/Movie

- 1 Select an i-motion/movie file from a downloadable site.
- 2 Select “Save” ▶ Select “YES”.
- 3 Select a destination folder.

Playing i-motion/Movie

- 1  ▶ Data box ▶  i-motion/Movie
- 2 Select a folder ▶ Select a file.

Osaifu-Keitai is equipped with the IC card which enables you to make payments, use coupons, enjoy stamp rallies and so on by placing the FOMA terminal over the scanning device in the stores or other locations. Furthermore, by placing the FOMA terminal over a scanning device, you can access sites and web pages, obtain the latest coupons by communication, and check the deposits of electronic money and the status of its use. Security of the card is well established so that you can use it carefree.

ToruCa is an electronic card that you can receive with FOMA terminal for use as fliers, restaurant cards, and coupon tickets. You can download ToruCa files from scanning devices, sites, or data broadcasting, and can easily exchange them using mail, infrared communication, iC communication, or a microSD card. The downloaded ToruCa files are saved to "ToruCa" on "Osaifu-Keitai".

For details on Osaifu-Keitai and ToruCa, refer to "Mobile Phone User's Guide [i-mode] FOMA version".

- Data on the IC card (including electronic money, reward points, etc.) might be lost or deformed owing to the malfunction of the FOMA terminal. (You cannot deposit your FOMA terminal at our hand for repair, remaining data files on it. You are asked, as a rule, to delete them by yourself.) As to the support such as reissue, restoration, temporal storage, and transfer of data, consult the provider of your Osaifu-Keitai compatible service, except for the transfer by the iC transfer service. For your important data, be sure to use Osaifu-Keitai compatible service with backup support.
- In any case including malfunction or model change, we cannot be held responsible for the loss or deformation of data on the IC card or other losses caused regarding Osaifu-Keitai compatible services.
- When your FOMA terminal is stolen or lost, immediately inquire of the provider of your Osaifu-Keitai compatible service about the countermeasures.
- Even when the power is turned off or the battery runs out, the "Osaifu-Keitai" function is available by holding the  mark over the scanning device. The function may not be available, however, if you do not use the battery pack for a long time or leave the battery uncharged after the low battery alert activates.

1 Place the mark over a scanning device.

The Call/Charging indicator lights when you bring your FOMA terminal close to the scanning device and communication becomes ready.

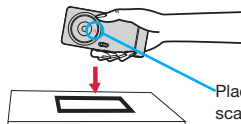

Place the  mark over a scanning device.

i-concier works to serve you with a pleasant life just like a clerk or concierge does. The service holds your data (area information about your neighborhood, Memo, Schedule, ToruCa, Phonebook, etc.) and sends you information, with good timing, about a variety of things according to the contents of your memo and your schedule event, your living area, your current location, or your preference or taste. This service provides related information about Memos, schedule events, or ToDo items, and automatically updates schedule events or ToruCa files to the latest, and also automatically adds useful information such as about the opening hours of various shops to your Phonebook. It also allows you to share the schedules or images held by the DOCOMO's Data Storage Center with friends, family members or other groups. It also enables you to easily print out the images held. i-concier information is notified by a Machi-chara image (cartoon character that appears on the Stand-by display).

- For details on i-concier, refer to "Mobile Phone User's Guide [i-mode] FOMA version".
- i-concier is a pay service which is available on a subscription basis (You need to subscribe to i-mode to apply for i-concier).
- If you have not subscribed to Data Security Service but will newly subscribe to i-concier, you are to subscribe to Data Security Service as well as i-concier.
- Depending on the content (information, i-schedule, and others), you might be charged separately an information fee other than the i-concier monthly fee.
- You are charged a packet communication fee separately for receiving information except some.
- You are charged separately a packet communication fee for using detailed information.
- You are charged separately a packet communication fee for auto-updates of i-schedule, Memo, ToruCa, and Phonebook, etc.
- i-concier is available in Japanese only.



Receiving Information

- 1 When information arrives,  blinks and the content is displayed on the Stand-by display.



- 2 Select a message
 - ▶ Select a piece of information.

Displaying i-concier

- 1  i-concier ▶  インフォメーション一覧 (Information list)
- 2 Select a piece of information.

Convenient Tools

Using Schedule

1 Tool ▶ Schedule

Select a date to show a schedule event of the selected date. Select the schedule event to confirm its details.



2 (Submenu) ▶ Select "New".

3 Enter each item.



4 Press (Finish).

Using Alarm

1 Tool ▶ Alarm

2 Highlight an alarm and press (Edit).

3 Enter each item.

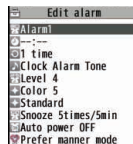

4 Press (Finish).

- The alarm does not sound in Public mode (Drive mode), Dial Lock, "Alarm" locked in Original Lock or Omakase Lock.

Using Bar Code Reader

You can use the camera to scan QR codes and others, and store them as files.

From the scanned data, you can make calls, compose i-mode mail messages, access Internet websites, and so on.

■When scanning with Bar Code Reader

- Scan the code as large as possible within the guide frame.
- Autofocus works when you scan the code about 10 cm or more away from it. When you scan the code in the out-of-focus state, the recognition rate lowers.
- Hold the camera in parallel with the code when you scan.



■QR code

QR code is one of the two-dimensional codes that denotes data in the vertical and horizontal directions.

- “株式会社NTTドコモ (NTT DOCOMO, INC.)” is displayed when you scan the QR code with the FOMA terminal.



Scan a Code

<Example> Access P-SQUARE by using QR code on the right



QR code for accessing the site

- 1 (MENU) ► Tool ► Bar code reader
- 2 Select “Scan code”.
- 3 Fit a code to the guide frame and press (O).
The subject is focused on by autofocus function.
- 4 Press (O) (Start) to scan the code.
A URL is displayed as a scanned result.
- 5 Select the URL ► Select “i-mode Browser”.

Bluetooth Function

You can connect your FOMA terminal to a Bluetooth device such as Wireless Earphone Set 02 (option), and can talk on the phone or play music files.

Registering a Bluetooth Device to FOMA Terminal

You can search and register a Bluetooth device to the FOMA terminal. You need to place the Bluetooth device to be registered standby for registration beforehand.

<Example> Register Wireless Earphone Set 02 and connect using the Hands-free service

1  ► Tool ► Bluetooth
► Register New Devices

2 Select "OK".

3 Select Wireless Earphone Set 02
► Select "YES".

- When you register a Bluetooth device other than Wireless Earphone Set 02, you need to enter "Bluetooth passkey".

4 Select "Hands-free".

Select "Headset" or "Hands-free" for talking, and select "Audio streaming" for playing music.

Connecting with Bluetooth Devices

1  ► Tool ► Bluetooth ► Device list

2 Select a Bluetooth device
► Select a service to be connected.

Wi-Fi

This FOMA terminal is compatible with Wi-Fi. You can access the Internet from your home access point or a public wireless LAN service using Full Browser. You can enjoy on-line communication by using Wi-Fi compatible devices such as portable game machine, personal computer, etc. in Access point mode.

- When you use Access point mode, you need to connect to the provider, such as mopera U.
- Connection is set to “mopera U 128k” at purchase.



Using Access Point Mode

1 Tool ▶ Wi-Fi ▶ Access point mode ▶ Start connecting

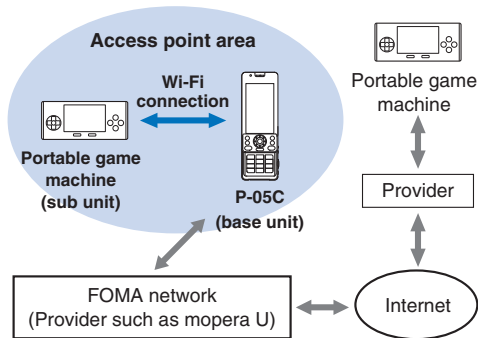
- When you use Access point mode for the first time, you are required to agree to the notes.



Using Client Mode

- 1  ► Tool ► Wi-Fi ► Client mode
- 2 Store profile ► Access point search
- 3 Select an Access point ►  (CNCT)
► Select "YES" ► Select "YES".

To activate or deactivate Client mode

Press and hold  for at least one second from the Stand-by display.

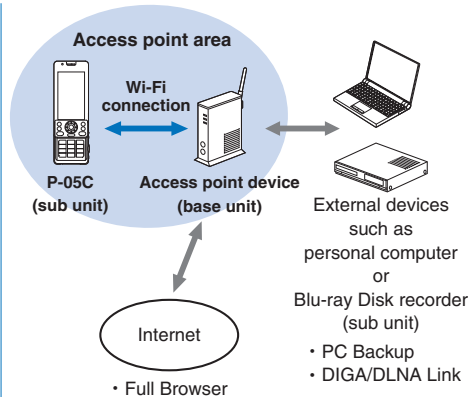

PC Backup

You can use Client mode to transfer uncopyrighted still images and moving pictures on your microSD card to your personal computer for backup.

DIGA/DLNA Link

You can use Client mode to display a still image shot with P-05C using external device or to play back a TV program recorded with DIGA device.

- If you do not insert a microSD card, this function is unavailable.



Playing Moving Pictures

You can play back a file in DIGA device by P-05C.

- 1  ▶ Tool ▶ DIGA/DLNA Link
- 2 Reference prog. of ext.
▶ Select a DIGA device.
- 3 Select a folder ▶ Select a file.

Downloading Still Images

You can download a still image from external device to microSD card in P-05C .

- 1  ▶ Tool ▶ DIGA/DLNA Link
- 2 Download pic. of ext.
▶ Select an external device.
- 3 Check a file to be downloaded
▶  (Finish)

Displaying Still Images

You can display a still image on microSD card in P-05C by external device.



- You can also operate this function using “Display pic.” on Picture Jump.

- 1  ▶ Tool ▶ DIGA/DLNA Link
- 2 Display pic. to ext.
▶ Select an external device.
- 3 Picture ▶ Select an item ▶ Select a file.

Uploading Still Images

You can upload a still image from microSD card in P-05C to external device.

- You can also operate this function using “Transfer pic.” on Picture Jump.

- 1  ▶ Tool ▶ DIGA/DLNA Link
- 2 Transfer pic. to ext.
▶ Select an external device.
- 3 Picture ▶ Select an item
▶ Check a file to be uploaded
▶  (Finish)

Using Pedometer

As you walk with your FOMA terminal in hand or in your pocket, your pace is measured, and then depending on the measured results, your distance, calories consumed, and body fat burned are displayed.

■ Caution when using Pedometer

- If you have not yet set Set Main Time, you cannot use this function.
- When you use Carry Case L 01/Carry Case 02 (option) to house it, fasten it to your waist belt.
- When you put Pedometer into your bag, store it in a pocket or partition that holds it securely.

■ About measurement

- Note that measurement results are just for reference.
- When the power is not turned on or while software is being updated, no measurement is carried out.
- Your pace might not be correctly measured depending on the usage conditions.

1 Tool ▶ Pedometer

The measurement records of your pace are displayed.

- From the submenu, you can switch between ON/OFF of Pedometer, or set user information.

Creating Handwriting Photo/Memo

On the touch panel, you can draw pictures or write characters by hand onto the images or you can add decoration. The Handwriting photos/memos you have created are saved as JPEG images.

1 Normal Menu ▶ Tool ▶ Handwriting photo/memo

2 Set background ▶ Edit Handwriting photo/ memo ▶ Touch “Finish”.

- You can draw pictures, write characters and position stamps.



3 Touch “Save in portrait” or “Save in landscape”.

4 Touch “Save to pictures”.

Using microSD Card

If you do not have a microSD card, you need to purchase it.

- P-05C supports a commercial microSD card of up to 2 Gbytes and microSDHC card of up to 32 Gbytes (As of May 2011).

For the latest operation, check information such as the memory capacity and manufacturers of microSD cards, access the following sites (in Japanese only). Note that the microSD cards other than published in the sites may not work correctly.

- From i-mode to P-SQUARE (As of May 2011)
 - ☎ Menu→メニューリスト (Menu List)
 - ケータイ電話メーカー (Mobile Phone Maker)
 - P-SQUARE
- From personal computers
 - <http://panasonic.jp/mobile/>

Note that the published information is the result obtained from the operation check, which does not necessarily guarantee all performances of those microSD cards.

- When you shoot a moving picture of Full HD (1920 x 1080) or HD (1280 x 720), you need Speed Class compatible microSD card.
- Make sure that you turn off the power, and then insert/remove the microSD card.



Inserting/Removing microSD Card

- 1 With the metal terminal surface facing downward, make sure that the cut edge is positioned at right and then insert.

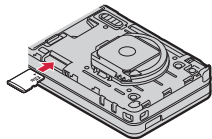

- Push it until it clicks.

When you remove the microSD card

Push the microSD card until it stops and remove it.





- Note that the microSD card may pop out when you insert or remove it.

The inserting slot of the microSD card is in the inside of the LUMIX Phone panel.



Icons on the Display



-  : A microSD card is inserted.
-  : Data is being read/written.
(Do not remove the microSD card nor turn off the FOMA terminal.)
-  : The microSD card is write-protected.
-  : The microSD card cannot be used.
(Insert the microSD card again. If “” is still displayed, execute “Check microSD” or “microSD format”.)

Formatting microSD Card

When you use the microSD card for the first time, you need to format (initialize) it.

- Be sure to use P-05C for formatting. The microSD card formatted using other devices such as personal computers may not work properly.
- Note that formatting deletes all content on the microSD card.

1



▶ Tool ▶ microSD

▶ Refer microSD data ▶  (Submenu)

▶ microSD format



2

Enter your Terminal Security Code

▶ Select “YES”.





Copying Data to microSD Card

<Example> Copying a still image

- 1  ▶ Data box ▶ My picture
▶ Select a folder.
- 2 Highlight a still image to be copied and press  ()
▶ Select “Copy to microSD”
▶ Select “Copy this”.

Copying Data to FOMA Terminal

<Example> Copying a still image

- 1  ▶ Data box ▶ My picture ▶  ()
▶ Select a folder.
- 2 Highlight a still image to be copied and press  ()
▶ Select “Copy to phone”
▶ Select “Copy this”.

Displaying Data Stored on microSD Card

<Example> Displaying a still image

- 1  ▶ Data box ▶ My picture ▶  ()
- 2 Select a folder ▶ Select an image.

Check Capacity of microSD Card

The total memory and used memory (estimated) in the microSD card can be displayed.

1.  ▶ Tool ▶ microSD ▶ Refer microSD data
2.  () ▶ Select “microSD info”.

Backing up Data to microSD Card

You can back up Phonebook entries, schedule events, mail messages, memos, bookmarks, and the settings on and information about your FOMA terminal collectively onto the microSD card. When restoring the backup data onto your FOMA terminal, they are collectively restored.

- Backing up data from the FOMA terminal onto the microSD card is collectively applied to all data, so emptied files in the FOMA terminal are also backed up on the microSD card. When you restore such data onto your FOMA terminal, emptied files on the microSD card overwrite the data in the FOMA terminal created later.

1 (MENU) ▶ Tool ▶ microSD ▶ Backup/Restore ▶ Backup to microSD

2 Enter your Terminal Security Code ▶ Select "YES".

To restore backup data to FOMA terminal

1. (MENU) ▶ Tool ▶ microSD ▶ Backup/Restore
▶ Restore to phone
2. Enter your Terminal Security Code ▶ Select "YES".

Sending/Receiving Data by Infrared Communication/iC Communication

You can send or receive data such as Phonebook entries to or from a device supporting infrared communication function or iC communication function.

- You cannot exchange data depending on the other party's device or FOMA terminal.

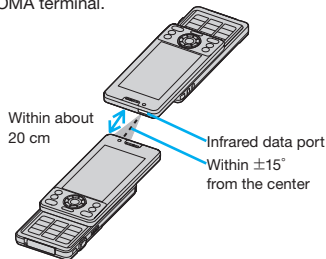

<Infrared communication>

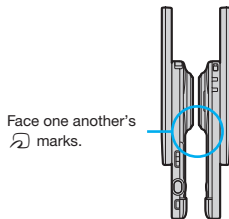

<iC communication>

Sending Data

- For infrared communications, set the receiving end terminal first, and then start sending data within 30 seconds.

1 Submenu of the data to be sent

▶ Select “Send Ir data” or “iC transmission”.

- Procedure for sending data might differ depending on the data.



2 Select “YES”.

Receiving Data by Infrared Communication

1  ▶ Tool ▶ Receive Ir data ▶ Receive

2 Select “YES”.

Receiving Data by iC Communication

1 Face the  mark of the receiving end terminal which shows the Stand-by display, to the  mark of the sending end terminal.

2 Select “YES”.

Connecting to a PC

You can connect the FOMA terminal to a personal computer to exchange WMA files, images or other files stored on microSD card.

You can also access the Internet to perform data communication.

※ You need the FOMA USB Cable with Charge Function 02 (option) or FOMA USB Cable (option).

※ To perform data communication, you need to install the “FOMA communication configuration file” (driver).

For details, refer to “Manual for PC Connection”.

You can download the “FOMA communication configuration file” and “Manual for PC Connection” from the DOCOMO website.

<http://www.nttdocomo.co.jp/english/support/>

DOCOMO Connection Manager

“DOCOMO Connection Manager” is a software which comes in handy for DOCOMO’s data communication.

It enables easy PC settings according with the terms and conditions of the user’s agreement.

It also makes it possible to check the amount of the data communication and provides a rough estimate of the charges using the charge counter function.

For details, refer to the DOCOMO website.

http://www.nttdocomo.co.jp/support/utilization/application/service/connection_manager/ (In Japanese only)



Troubleshooting

- First of all, check to see if you need to update the software program and then update it if necessary. See page 98 for how to update software programs.
- When symptom persists even after you check the countermeasures for the problem you suffer, contact the “Repairs” counter listed on the back page of this manual or a repair counter specified by DOCOMO.
The “Repairs” counter is available in Japanese only.

Power source

The FOMA terminal does not turn on.

- … Make sure the battery pack is attached to the FOMA terminal correctly. (See page 19)
- … Make sure the battery is fully charged. (See page 20)

Charging

Cannot charge.

(The Call/Charging indicator does not light, or it flickers.)

- … Make sure the battery pack is attached to the FOMA terminal correctly. (See page 19)
- … Make sure the power plug of the adapter is securely inserted into the outlet or cigarette lighter socket.
- … Make sure the adapter and the FOMA terminal are connected correctly. (See page 20)
- … When you use an AC adapter (option), make sure its connector is firmly connected to the FOMA terminal or a desktop holder (option). (See page 20, page 21)
- … When you use the desktop holder, make sure the connector terminal of the FOMA terminal is not stained. If it is stained, wipe the terminal part with a dry cotton swab, etc.
- … If you talk on the phone, have communications, or operate other functions for a long time during battery charge, the temperature of the FOMA terminal may rise to flicker the Call/Charging indicator. In that case, charge the battery after the FOMA terminal cools down. (See page 20)

Operation of terminal

While you operate the FOMA terminal or charge the battery, they get hot.

- … While operating or charging, or when you operate i-appli programs, talk on the videophone, or watch 1Seg programs for a long time during battery charge, the FOMA terminal, battery pack, or adapter may become warm, but this is not a safety hazard, so you can continue to use them.

The usable time of the battery is short.

- …Make sure not to leave the FOMA terminal out-of-service-area for a long time. If your FOMA terminal is left out-of-service area, it searches for radio waves to establish communications, consuming more power.
- …The usable time of the battery pack varies depending on the usage environment or its remaining life.
- …Battery packs are consumables. The usable time slightly shortens each time you charge the battery. If the usable time becomes extremely short as compared with the default state even if fully charged, purchase the specified battery pack.

The power of the FOMA terminal shuts down and restarts.

- …If the terminal of the battery pack is stained, the connection might deteriorate to shut down the power. Wipe the battery terminal with a dry cotton swab, etc.

Pressing keys is disabled.

- …Make sure Dial Lock is deactivated. (See page 42)
- …Make sure Keypad Lock is deactivated. (See page 43)

The UIM is not recognized.

- …Make sure you insert the UIM in the correct direction. (See page 19)

The clock does not show the correct time.

- …The clock may not show the correct time when the power has been kept on for a prolonged period of time. Check whether “Auto time adjust” and “Auto time difference” of “Set main time” have been set to “Auto” and then, move to a location with good signal reception, turn off the power of FOMA terminal and then back on.

Call

Cannot make a call by pressing numeric keys.

- …Make sure Restrict Dialing is deactivated.
- …Make sure the lock for “Keypad dial” in Original Lock is released. (See page 43)
- …Make sure Dial Lock is deactivated. (See page 42)
- …Make sure Self Mode is deactivated.

Cannot talk.

(“” does not disappear even if you move to another place. You cannot make or receive a call, though the radio wave conditions are not bad.)

- …Turn off and on the FOMA terminal, or remove and attach/insert the battery pack or UIM. (See page 19, page 22)
- …Depending on the characteristics of the radio waves, you may not be able to make or receive a call even if the FOMA terminal is “within service area” or “” is displayed for a radio wave condition. Move to another place and redial.
- …Make sure the call restrictions such as Call Rejection, Call Acceptation, etc. are deactivated.
- …Depending on the radio wave congestion state, calls and mail messages may be congested and hard to be connected in crowded places. In that case, the message “Please wait” or “Please wait for a while” is displayed and a busy tone sounds. Move to another place or wait for a while, and then redial.

Osaifu-Keitai

Cannot use Osaifu-Keitai function.

- …If you remove the battery pack or activate Omakase Lock, the Osaifu-Keitai function becomes unavailable regardless of the setting of IC Card Lock. (See page 19, page 43)
- …Make sure IC Card Lock is deactivated. (See page 42)
- …Make sure you place the  mark on the FOMA terminal over the scanning device. (See page 80)

Warranty and After-sales Service

Warranty

- Make sure that you have received a warranty card provided at purchase. After checking the contents of the warranty card as well as “Shop name and date of purchase”, keep the warranty card in a safe place. If you notice that necessary items of the warranty card are not filled in, immediately contact the shop where you purchased the FOMA terminal from. The term of the warranty is one year from the date of purchase.
- All or part of this product including the accessories may be modified for improvement without notice.

After-sales Services

◎When there is a problem with the FOMA terminal

Before asking repairs, check “Troubleshooting” in this manual or in “使いかたガイド (Guide)” mounted on the FOMA terminal. (“使いかたガイド (Guide)” is available in Japanese mode only.) If the problem remains unsolved, contact the “Repairs” counter listed on the back page of this manual for malfunction and consult them. The “Repairs” counter is available in Japanese only.

◎When repairs are necessitated as a result of consultation

Bring your FOMA terminal to a repair counter specified by DOCOMO. Note that your FOMA terminal is accepted for repair during the repair counter’s business hours. Further, note that you may need to wait for fixing depending on the malfunction state.

■In warranty period

- Your FOMA terminal is repaired charge free in accordance with the terms of warranty.
- Make sure that you bring the warranty card to the counter for repair. If you do not show the warranty card, or when troubles or malfunctions are regarded to be caused by your mishandling (the damages of liquid crystal, connector, etc.), the repair cost is charged even within the warranty period.
- The cost for troubles caused by the use of devices and consumables other than those specified by DOCOMO is charged even within the warranty period.

■Repairs may not be carried out in the following cases:

- When exposure to water is found at our repair counter (Example: When the moisture detection sticker has reacted)
- When, as a result of inspection at our repair center, corrosion is found due to exposure to water, dew condensation, or sweat, or when damage or deformation is found in the circuit board [Repairs might not be carried out when damage to the connector terminal (earphone/microphone terminal) or liquid crystal, or cracks in the body are found.]

※Even if repair is feasible, the repair cost is charged when the trouble you suffer matches one of the symptoms listed above, which is not supported by the warranty.

■After the warranty period

We will repair your FOMA terminal on request (charges will apply).

■Spare parts availability period

The minimum storage period of the performance spare parts (parts required for maintaining performance) for the FOMA terminal is basically six years after the closure of its production. Note, however, that your FOMA terminal might not be repaired depending on the troubled portions because of the shortage of spare parts.

◎Other points to note

- Make sure not to modify the FOMA terminal or its accessories.
 - We might reject to repair depending on the degrees of your modification.
The following might be regarded as modifications:
 - To put stickers, etc. onto the liquid crystal or keys
 - To decorate the FOMA terminal using adhesives
 - To replace the coverings etc. with those of other than DOCOMO genuine products
 - Repairs of troubles or malfunctions resulting from the modifications are charged even within the warranty period.
- Do not peel the nameplate off the FOMA terminal.
Note that when we cannot ensure the contents described on the nameplate and therefore cannot verify the product conformity to the technical standard, it might happen that we at DOCOMO reject to repair the malfunction.
- The information such as about function settings, etc. might be reset depending on the troubles or repairs, or the way you handle the FOMA terminal. Set the settings again.
- If the FOMA terminal is repaired, the Wi-Fi MAC Address and the Bluetooth Address may change, regardless of the area that was originally damaged.
- The parts generating magnetism are used in the following portions of the FOMA terminal. Note that if you place a magnetism-sensitive object such as a cash card near the FOMA terminal, the card might become unusable.
Portions: speaker, earpiece
- If the FOMA terminal gets wet or becomes moist, immediately turn off the power and remove the battery pack; then visit a repair counter. The FOMA terminal may not be repaired depending on the condition.

i-mode Fault Diagnosis Site

You can check on your FOMA terminal whether sending/receiving mail messages, downloading images/melodies, and others are normally working. When you think your FOMA terminal is in trouble as a result of your check, contact the “Repairs” counter listed on the back page of this manual. The “Repairs” counter is available in Japanese only.

- To connect to “i モード故障診断サイト (i-mode Fault Diagnosis Site)” [in Japanese only]
i-mode site: ☎ Menu → お知らせ (News)
 - サポート情報 (Support information)
 - お問い合わせ (Inquiries)
 - 故障・電波状況お問い合わせ先 (Failures & Radio wave condition)
 - i モード故障診断 (i-mode Fault Diagnosis)



QR code for
accessing the site

- When you use overseas, you are charged a fee.

Updating Software

This function is to check whether you need to update software programs in the FOMA terminal by connecting to the network, and if necessary, you can download some parts of software programs using packet communication, and can update the software programs.

If you need to update the software programs, the DOCOMO website and “お客様サポート (User support)” in Japanese ☎ Menu lets you know information about updating software programs. There are three kinds for updating software programs; “Auto-update”, “Update Now” and “Reserve Update”.

- You can update software programs, with data retained, such as Phonebook entries, images shot by the camera, or downloaded data in the FOMA terminal; however note that data may not be protected depending on the conditions (such as malfunction, damage, or drench) your FOMA terminal is placed in. You are advised to back up important data. Note that data such as downloaded ones might not be backed up.

■ Before using Software Update

- Do not remove the battery pack while updating software programs. You may fail to update.
- Fully charge the battery before updating software programs.
- It may take time to update (download or rewrite) software programs.
- You cannot make/receive calls, use communication functions, and other functions while updating software programs. (You can receive voice calls during download.)
- You are advised to update software programs when radio wave is strong enough with the three antennas displayed and while you are not moving. If radio wave conditions get worse while downloading software programs, or download is suspended, move to a place with better radio wave conditions and try again to update software programs.
- When updating software programs, the proprietary information about your FOMA terminal (model name or serial number, etc.) is automatically sent to the server (DOCOMO-managed server for Software Update). We at DOCOMO never use the sent information for purposes other than to update software programs.
- If you fail to update software programs, “Rewrite failed” is displayed and you cannot do all operations. In that case, you are kindly requested to come to a repair counter specified by DOCOMO.



Start Software Update from Icon

- 1 Select “Update notification icon” on the Stand-by display.

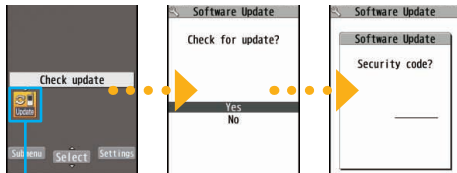

Update notification icon

Check whether you need to update software programs.

- 2 When update is necessary, “Update is needed” is displayed. And you can select either “Now update” or “Reserve”.

- When you select “Now update”, update immediately starts.
- When rewriting is completed, your FOMA terminal automatically restarts and the Update Completion Confirmation display appears.
- When you select “Reserve”, you can select the date and time you want.

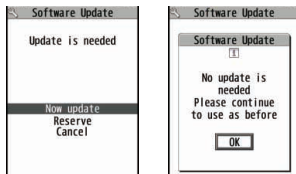

Start Software Update from Menu

- 1  Setting ▶ Other setting
▶ Software Update
- 2 Enter your Terminal Security Code
▶ Select “Update”.

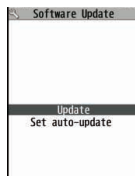

- 3 Go to step 2 of “Start Software Update from Icon” on page 99.

Scanning Function

You can detect data or application programs, which might cause troubles, from among those downloaded to your FOMA terminal, and then can delete the data or stop starting the application programs.

- This scan function provides a certain protective measure to filter out data that might cause troubles with your FOMA terminal at the time when you browse websites or receive messages. Note that when the virus pattern data supporting respective troubles is not yet downloaded to your FOMA terminal, or when no virus pattern data supporting them is found, this function does not prevent troubles from occurring.

Updating pattern data

First of all, update the pattern data to obtain the latest.

-  Setting ▶ Lock/Security ▶ Scanning function ▶ Update ▶ YES
▶ YES

Displays for scanning results

- About the display for scanned problem elements

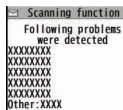









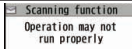

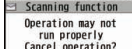
Scanning function
Following problems
were detected
XXXXXXXXXX
XXXXXXXXXX
XXXXXXXXXX
XXXXXXXXXX
XXXXXXXXXX
XXXXXXXXXX
Other:XXXX

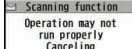
A warning display appears when problematic data is found. Press  (Detail) from the warning display to show the name of the problem element.

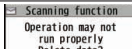
- When six or more problem elements are found, the sixth and later problem element names are omitted.
- "Detail" might not appear depending on the detected problem element.

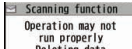
- The displays for scanning result

Alert level 0		Press  (OK) to continue the operation.
Alert level 1		Press  (YES) to stop and end the operation. Press  (NO) to continue the operation.
Alert level 2		Press  (OK) to stop and end the operation.
Alert level 3		Press  (YES) to delete the data and end the operation. Press  (NO) to stop and end the operation.
Alert level 4		Press  (OK) to delete the data and end the operation.

- The alert displays differ from shown above may appear.

Options and Related Devices

Combining various options with the FOMA terminal, you can realize more versatile use from personal purpose to business purposes. Some products may not be dealt in depending on the area. For details, consult a handling counter such as a docomo Shop. For details on options, refer to the user's manuals of respective options and related devices.

- Battery Pack P20
- LUMIX Phone Panel P50
- Desktop Holder P46
- FOMA AC Adapter 01/02^{※1}
- FOMA AC Adapter 01 for Global use^{※1}
- FOMA DC Adapter 01/02
- FOMA Portable Charging Adapter 01/02/03
- FOMA Dry Battery Adapter 01
- FOMA eco Solar Panel 01
- FOMA USB Cable with Charge Function 02^{※2}
- FOMA USB Cable^{※2}
- FOMA Indoor Booster Antenna^{※3}
- FOMA Indoor Booster Antenna (Stand Type)^{※3}
- Carry Case L 01
- Carry Case 02
- In-Car Holder 01
- Earphone/Microphone 01
- Stereo Earphone Set 01
- Earphone/Microphone with Switch P001/P002^{※4}
- Flat-plug Earphone/Microphone with Switch P01/P02^{※5}
- Flat-plug Stereo Earphone Set P01^{※5}
- Earphone Plug Adapter P001^{※5}
- Earphone Plug Adapter for External connector terminal 01
- Earphone Plug Adapter 01
- Flat-plug Connector/Stereo Mini-jack Conversion Adapter P01^{※5}
- Bluetooth Headset F01^{※6}
- AC Adapter for Bluetooth Headset F01
- Wireless Earphone Set P01/02
- Bone conduction microphone/receiver 01^{※5/02}
- In-Car Hands-Free Kit 01^{※7}
- FOMA In-Car Hands-Free Cable 01

※1 See page 20, page 21 for charging batteries using AC adapter.

※2 If you use a USB hub, outer devices may not work correctly.

※3 Use it in Japan only.

※4 Earphone Plug Adapter P001 and Earphone Plug Adapter for External connector terminal 01 are required.

※5 Earphone Plug Adapter for External connector terminal 01 is required.

※6 AC Adapter for Bluetooth Headset F01 is required.

※7 To charge the P-05C, FOMA In-Car Hands-Free Cable 01 is required.

Function List

Execute “Resetting the Function Settings to Default” on page 44 for the items indicated by to return to the respective defaults.

Mail	Inbox		
	Outbox		
	Draft		
	Mail history box		
	Compose new message		
	Create new Deco-Anime		
	Decome-Template	Deco-mail	
		Decome-Anime	
	Compose new SMS		
	Check mail/message		
	Check new SMS		
	Receive option		
	Mail setting	Receive setting	
		Display setting	
		Text predict	
Signature setting			
Phrases/Store word			
Mail box lock			
Set check mail/message			
Address/Spam Mail Set.			
Auto save setting			
SMS setting			

Mail	Mail setting	Area Mail setting	
		Auto Deco-mail setting	
		Check settings	
		Reset	

mode/web	Menu/Search		
	Bookmark		
	Screen Memo		
	Browsing history		
	Enter URL	Enter URL	
		URL enter history	
	i-Channel	i-Channel list	
		Ticker display setting	
		Reset i-Channel	
	mode/web setting	mode Browser Set.	
Full Browser Settings			
Common Settings			
Confirm mode setting			
	Reset mode setting		
Full Browser Home			

αppli	Software list (phone)		
	αppli (microSD)	Software list	
		αppli data	
	αppli call logs		
	αppli run info	End stand-by info	
		End Widget appli info	
Security error history			
Auto start info			

αappli	αappli run info	Trace info
	αappli setting	Auto-start setting
		Disp. software info
		i-Widget overseas use
		i-Widget sound effect
		AUTO-GPS preferred set
		i-αappli call settings
		αappli volume
		Preferred tone
		αBacklight
		αVibrator
	Check settings	

CAMERA/TV/MUSIC	Camera	Digicam mode
		Photo mode
		Movie mode
		Picture album
		Activate 1Seg
	1Seg	Program guide
		TV timer list
		Timer recording list
		Recording result
		TVlink
		Channel list
		Channel setting
		User setting
	MUSIC Player	
	Music&Video Channel	

Data box	My picture	
	MUSIC	
	Music&Video Channel	
	motion/Movie	
	Melody	
	Content package	
	My document	
	Kisekai Tool	
	Machi-chara	
	Chara-den	
	1Seg	Image
		Video
		Position memory
	Document viewer	
	Font	
SD other files		
Search all history		

Tool	Bar code reader	Scan code
		Saved data
	Calculator	
	Alarm	
	Receive Ir data	Receive
		Receive all
	Schedule	
	Memo	
	Pedometer	

Tool	Data Security Service	Data check/Download
		Update phonebooks etc.
		Update images
		Update setting info
		Setting/History
	microSD	Refer microSD data
		Backup/Restore
	Guide	
	Voice recorder	
	Bluetooth	Device list
		Register New Devices
		Bluetooth ON/Bluetooth OFF
		Accept registered
		Accept dialup devices
		Bluetooth settings
	Wi-Fi	Client mode
		Access point mode
	mixi setting	
	PicMate setting	
	GREE setting	
PC backup	Backup	
	Store AP for backup	
	AP list for backup	
	Backup history	
	Auto notice for backup	
DIGA/DLNA Link		
DIGA remote controller		
Voice announce		

Tool	Dictionary	Enter word
		Reference history
	Phrases/Store word	Common phrases
		Store word
	Download dictionary	
Contact DOCOMO		

TEL function	Phonebook	Search phonebook
		Add to phonebook
		UIM operation
		Phonebook set./Check
		Forwarding image
	Choku-Den	
	Rec. msg./Voice memo	Play/Delete msg.
		Play/Delete VP msg.
		Record voice memo
		Record message setting
	Dialed/Received call	Dialed calls
		Received calls
		Redial
	Dial/Receive setting	Nuis. call blocking
		Caller ID request
		Caller ID notification
		Arrival call act
		Dial call setting
		Receive call setting
		In-call setting
Headset function set.		
Call rejection set.		

TEL function	Dial/Receive setting	Missed call notice
	Videophone setting	Visual preference
		Select image
		Auto redial as voice
		Ntfy switch-mode
		Reject videophone
		Hands-free switch
		V.phone while packet
	Call duration/charge	Call duration/charge
		Notify cost limit
		Reset total
		Auto reset
	Koe-no-Takuhaibin	Play messages
		Settings
	2in1	
	Melody call	
	Voice mail service	Play messages
		Activate
		Deactivate
		Set ring time
		Check setting
		Voice mail setting
		Check messages
Message notification		
Delete icon		
Setting for videophone		

TEL function	Other network serv.	Call forwarding
		Call waiting
		English guidance
		Remote access
		Multi Number
		Dual network
		Additional service
		OFFICEED

Setting	Screen/Display	Kisekae Tool setting
		Stand-by display
		Color theme setting
		Each display setting
		Machi-chara setting
		Soft key
		Private menu setting
		Menu Theme
		Viewer settings
		Icons
		Icons setting
		View blind
		Image display mode
		LCD AI
		Mail ticker display
Information display		

Setting	Sound/Vib./Manner	Ring volume
		Select ring tone
		Other sound setting
		Vibrator setting
		Manner mode setting
		Stereo&3D sound
		Machi-chara chat set.
	Backlight/Illum.	Backlight
		Illumination setting
	Text display/input	Font
		Character input set
		パイリンガル
	Time	Set main time
		Sub clock setting
		Clock display
		Auto power ON
		Auto power OFF
	Lock/Security	Lock
		Keypad lock
		Secret mode
		Secret data only mode
		Call rejection set.
		Change security code
		UIM setting
Scanning function		
Timer lock ON at close		
IC card lock setting		

Setting	Battery	eco mode
		eco mode setting
		eco mode autostart
		Use history
		Battery level
	External connection	USB mode
		Bluetooth
		Headset microphone
		Femtocell
	Other setting	Wi-Fi
		Touch menu open set.
		Speed selector setting
		Motion control setting
		Camera-button setting
		Alarm setting
		Self mode
		Reset settings
		Initialize
		Software Update
		Quick search URL

Map/Overseas	Map	
	Navigation	
	imadoco search	imadoco kantan search
		imadoco search
	i-area	
	GPS appli list	
	Position/Notify	Position location
	Location notification	

Map/Overseas	Map&GPS set./history	Location history
		Map setting
		GPS button setting
		Location request set.
		AUTO-GPS
		Positioning mode set.
		Register LCS client
		Service setting
		Serv. host URL set.
		Illum./Tone settings
		Overseas NW search
		Network search setting
		PLMN setting
		Display operator name
		Display area status
		Re-search icon set.
	Overseas setting	Inquiries (overseas)
		Sub clock setting
		Bar incoming when roam
		Missed call notice
		Roaming guidance
		Int'l dial assistance
		mode service set.
		Mail/Message usage set
	Network service	
	Overseas use guide	
	i-concier	

Profile		
Osafu-Keital	IC card content	
	DCMX	
	ToruCa	
	IC card lock setting	IC card lock
		IC lock (power-off)
	Setting	ToruCa settings
		Receive ToruCa
		IC card notice set
	Check IC owner	
	Change IC owner	
Search by mode		
Others	Character input	
	Home Menu	
	Customize Menu	

Main Specifications

■ Handset

Model		P-05C	
Dimensions (when closed)		Height: Approx. 116 mm Width: Approx. 52 mm Depth: Approx. 17.7 mm (at thickest point: Approx. 24 mm)	
Weight (with the battery pack attached)		Approx. 149 g	
Continuous standby time	FOMA/3G	3G/GSM setting [3G]	In motion: Approx. 350 hours
		3G/GSM setting [Auto]	Standstill: Approx. 530 hours In motion: Approx. 330 hours
	GSM	3G/GSM setting [Auto]	Standstill: Approx. 230 hours
Continuous talk time	FOMA/3G		Voice call : Approx. 210 minutes Videophone call : Approx. 100 minutes
	GSM		Voice call: Approx. 220 minutes
1Seg watching time		Approx. 310 minutes (in 1Seg eco Mode: Approx. 350 minutes)	
Charging time		AC adapter: Approx. 120 minutes DC adapter: Approx. 120 minutes	
Display	Type	TFT 262,144 colors	
	Size	Approx. 3.3 inches	
	Number of pixels	409,920 pixels (480 dots x 854 dots)	
Image pickup device	Type	CMOS	
	Size	1/2.4 inches	
Camera	Number of effective pixels	Approx. 13,200,000 pixels	
	Number of recording pixels (maximum)	Approx. 13,000,000 pixels	

Recording	Number of recordable still images**1	Approx. 1,400 max. (default)
	Number of still images for continuous shooting	For Digicam Mode in Continuous setting 3M: 8 2M Wide: 8 2M: 8 Stand-by: 8 For Continuous Mode VGA: 4 QVGA: 5 to 10 QCIF: 5 to 20 Sub-QCIF: 5 to 20
Music playback	Continuous playback time**2	SD-Audio file (supports Play Background): Approx. 6,500 minutes**3 Chaku-uta Full® music file (supports Play Background): Approx. 6,000 minutes**3 i-motion file (including Chaku-uta® music file): Approx. 420 minutes**3 WMA file (supports Play Background): Approx. 4,600 minutes Music&Video Channel program (supports Play Background) Sound : Approx. 6,000 minutes Moving picture: Approx. 270 minutes
Memory capacity	Chaku-uta®	Approx. 201 Mbytes (default)**4
	Chaku-uta Full®	
Wireless LAN		Compliant with IEEE802.11b/g/n (2.4GHz)

“Chaku-uta” is a registered trademark of Sony Music Entertainment Inc.

※1 Picture size: QVGA (320 x 240), Quality: Standard, File size: 25 Kbytes

※2 The continuous playback time is the estimated duration that you can play back using the Stereo Earphone Set 01 (option) with the FOMA terminal closed.

※3 File format: AAC

※4 Shares with still images, i-motion files, melodies, PDF files, Music&Video Channel programs, Kisekae Tool files, Machi-chara images, Content packages, Font, Screen memos, ToruCa files, and i-αpli programs.

■ Battery pack

Name of product	Battery Pack P20
Battery type	Li-ion (lithium ion) battery
Voltage	3.7 V
Capacity	800 mAh

■ Specifications of shooting

<Still image (Photo mode)>

File format (Extension)	JPEG (jpg)
The number of files that can be saved to P-05C	Approx. 1,400 max. ※1※2
The number of files that can be saved to the microSD card (2 Gbytes)	Approx. 61,466 max. ※2

<Moving picture (Movie mode)>

File format (Extension)	MP4, ASF (3gp, asf)
Recordable time to P-05C	Approx. 30 seconds max. ※1※3
Recordable time to the microSD card (2 Gbytes)	Approx. 180 minutes max. ※4

<Zoom>

Still image (Photo mode)	Level of zoom	21 levels
	The maximum magnifications	Approx. 16.2 times
Moving picture (Movie mode)	Level of zoom	21 levels
	The maximum magnifications	Approx. 10.8 times

※1 Default setting

※2 The number of files that can be saved under the conditions of "Picture size: QVGA (320 x 240), Quality: Standard, File size: 25 Kbytes".

※3 Maximum recording duration per shot that can be saved to the main unit under the conditions of "Movie size: VGA (640 x 480), File size: Mail restriction (L), Quality: Standard, Movie type set: Normal".

※4 Maximum recording duration per shot that can be saved to the microSD card (2 Gbytes) under the conditions of "Movie size: VGA (640 x 480), File size: Long time, Quality: Standard, Movie type set: Normal".

■ Recordable time of 1Seg

Maximum (total) recordable time to the microSD card (2 Gbytes)	Approx. 640 minutes
Maximum (total) recordable time to the microSDHC card (32 Gbytes)	Approx. 10,240 minutes

- The maximum recordable time is the estimate for 224 kbps of video, 48 kbps of audio, and 52 kbps of data (including captions). The recordable time varies depending on the broadcasting station or program.
- The maximum file size for continuous recording is up to 2 Gbytes under SD-VIDEO specifications.

■ Number of savable/registerable items in FOMA terminal

Function		Number of savable/registerable items
Phonebook		1,000
Schedule		2,500
Mail	Received mail	2,500 max. ※1※2
	Sent mail	1,000 max. ※2
Still image		3,500 max. ※2
i-motion file		3,500 max. ※2
Music&Video Channel	Downloaded program	2
	Saved program	10 max. ※2
Kisekai Tool		3,500 max. ※2
i-appli		100 max. ※2

※1 Includes pre-installed data.

※2 The number of savable/registerable items may decrease depending on the data volume.

Specific Absorption Rate (SAR) of Mobile Phone

SAR Certification Information

This model P-05C mobile phone complies with Japanese technical regulations and international guidelines regarding exposure to radio waves.

This mobile phone was designed in observance of Japanese technical regulations regarding exposure to radio waves* and limits to exposure to radio waves recommended by a set of equivalent international guidelines. This set of international guidelines was set out by the International Commission on Non-Ionizing Radiation Protection (ICNIRP), which is in collaboration with the World Health Organization (WHO), and the permissible limits include a substantial safety margin designed to assure the safety of all persons, regardless of age and health condition.

The technical regulations and international guidelines set out limits for radio waves as the Specific Absorption Rate, or SAR, which is the value of absorbed energy in any 10 grams of tissue over a 6-minute period. The SAR limit for mobile phones is 2.0 W/kg. The highest SAR value for this mobile phone when tested for use at the ear is 0.482 W/kg. There may be slight differences between the SAR levels for each product, but they all satisfy the limit.

The actual SAR of this mobile phone while operating can be well below that indicated above. This is due to automatic changes to the power level of the device to ensure it only uses the minimum required to reach the network. Therefore in general, the closer you are to a base station, the lower the power output of the device.

This mobile phone can be used in positions other than against your ear. This mobile phone satisfies the international guidelines when used with a carrying case or a wearable accessory approved by NTT DOCOMO, INC.** In case you are not using the approved accessory, please use a product that does not contain any metals, and one that positions the mobile phone at least 1.5 cm away from your body.

The World Health Organization has stated that present scientific information does not indicate that there are harmful effects attributed to the use of mobile devices. They recommend that if you are worried about your exposure then you can limit your usage or simply use a hands-free kit to keep the mobile device away from the head and body. Please refer to the WHO website if you would like more detailed information.

http://www.who.int/docstore/peh-emf/publications/facts_press/fact_english.htm

Please refer to the websites listed below if you would like more detailed information regarding SAR.

Ministry of Internal Affairs and Communications Website:

<http://www.tele.soumu.go.jp/e/sys/ele/index.htm>

Association of Radio Industries and Businesses Website:

<http://www.arib-emf.org/index02.html> (In Japanese only)

NTT DOCOMO, INC. Website:

<http://www.nttdocomo.co.jp/english/product/sar/>

Panasonic Mobile Communications Co., Ltd. Website:

<http://panasonic.jp/mobile/> (In Japanese only)

- * Technical regulations are defined by the Ministerial Ordinance Related to Radio Law (Article 14-2 of Radio Equipment Regulations).
- ** Regarding the method of measuring SAR when using mobile phones in positions other than against the ear, international standards (IEC62209-2) were set in March of 2010. On the other hand, technical regulation is currently being deliberated on by national council. (As of May, 2011)

European RF Exposure Information

This mobile phone complies with the EU requirements for exposure to radio waves.

Your mobile phone is a radio transceiver, designed and manufactured not to exceed the SAR* limits** for exposure to radio-frequency (RF) energy, which SAR* value, when tested for compliance against the standard was 0.496 W/kg.

While there may be differences between the SAR* levels of various phones and at various positions, they all meet*** the EU requirements for RF exposure.

- * The exposure standard for mobile phones employs a unit of measurement known as the Specific Absorption Rate, or SAR.
- ** The SAR limit for mobile phones used by the public is 2.0 watts/kilogram (W/kg) averaged over ten grams of tissue, recommended by The Council of the European Union. The limit incorporates a substantial margin of safety to give additional protection for the public and to account for any variations in measurements.
- *** Tests for SAR have been conducted using standard operating positions with the phone transmitting at its highest certified power level in all tested frequency bands. Although the SAR is determined at the highest certified power level, the actual SAR level of the phone while operating can be well below the maximum value. This is because the phone is designed to operate at multiple power levels so as to use only the power required to reach the network. In general, the closer you are to a base station antenna, the lower the power output.

Declaration of Conformity

CE 0168

The product "P-05C" is declared to conform with the essential requirements of European Union Directive 1999/5/EC Radio and Telecommunications Terminal Equipment Directive 3.1(a), 3.1(b) and 3.2. The Declaration of Conformity can be found on <http://panasonic.net/pmc/support/index.html>.

※ The European RTTE approval of this product is limited to the use of the P-05C handset, Battery Pack and FOMA AC Adapter for Global use (100 to 240 V AC) only. Other accessories are not part of the approval.

FCC Notice

- This device complies with part 15 of the FCC Rules. Operation is subject to the following two conditions:
 - (1) This device may not cause harmful interference, and
 - (2) This device must accept any interference received, including interference that may cause undesired operation.
- Changes or modifications not expressly approved by the manufacturer responsible for compliance could void the user's authority to operate the equipment.

FCC RF Exposure Information

This model phone meets the U.S. government's requirements for exposure to radio waves.

Your wireless phone contains a radio transmitter and receiver. Your phone is designed and manufactured not to exceed the emission limits for exposure to radio frequency (RF) energy set by the Federal Communications Commission of the U.S. Government. These limits are part of comprehensive guidelines and establish permitted levels of RF energy for the general population. The guidelines are based on standards that were developed by independent scientific organizations through periodic and thorough evaluation of scientific studies. The exposure standard for wireless mobile phones employs a unit of measurement known as the Specific Absorption Rate (SAR). The SAR limit set by the FCC is 1.6 W/kg.* Tests for SAR are conducted using standard operating positions accepted by the FCC with the phone transmitting at its highest certified power level in all tested frequency bands. Although the SAR is determined at the highest certified power level, the actual SAR level of the phone while operating can be well below the maximum value. This is because the phone is designed to operate at multiple power levels so as to use only the power required to reach the network. In general, the closer you are to a wireless base

station antenna, the lower the output.

Before a phone model is available for sale to the public, it must be tested and certified to the FCC that it does not exceed the limit established by the U.S. government-adopted requirement for safe exposure. The tests are performed in various positions and locations (for example, at the ear and worn on the body) as required by FCC for each model. The highest SAR value for this model phone as reported to the FCC when tested for use at the ear is 1.010 W/kg, and when worn on the body in a holster or carry case, is 0.412 W/kg. (Body-worn measurements differ among phone models, depending upon available accessories and FCC requirements). While there may be differences between the SAR levels of various phones and at various positions, they all meet the U.S. government requirement.

The FCC has granted an Equipment Authorization for this model phone with all reported SAR levels evaluated as in compliance with the FCC RF exposure guidelines. SAR information on this model phone is on file with the FCC and can be found under the Display Grant section at <http://www.fcc.gov/oet/ea/fccid/> after search on FCC ID UCE211039A. For body worn operation, this phone has been tested and meets the FCC RF exposure guidelines when used with an accessory designated for this product or when used with an accessory that contains no metal and that positions the handset a minimum of 1.5 cm from the body.

* In the United States, the SAR limit for wireless mobile phones used by the public is 1.6 watts/kg (W/kg) averaged over one gram of tissue. SAR values may vary depending upon national reporting requirements and the network band.

Important Safety Information

AIRCRAFT

Switch off your wireless device when boarding an aircraft or whenever you are instructed to do so by airline staff. If your device offers a 'flight mode' or similar feature consult airline staff as to whether it can be used on board.

DRIVING

Full attention should be given to driving at all times and local laws and regulations restricting the use of wireless devices while driving must be observed.

HOSPITALS

Mobile phones should be switched off wherever you are requested to do so in hospitals, clinics or health care facilities. These requests are designed to prevent possible interference with sensitive medical equipment.

PETROL STATIONS

Obey all posted signs with respect to the use of wireless devices or other radio equipment in locations with flammable material and chemicals. Switch off your wireless device whenever you are instructed to do so by authorized staff.

INTERFERENCE

Care must be taken when using the phone in close proximity to personal medical devices, such as pacemakers and hearing aids.

Pacemakers

Pacemaker manufacturers recommend that a minimum separation of 15 cm be maintained between a mobile phone and a pacemaker to avoid potential interference with the pacemaker. To achieve this use the phone on the opposite ear to your pacemaker and do not carry it in a breast pocket.

Hearing Aids

Some digital wireless phones may interfere with some hearing aids. In the event of such interference, you may want to consult your hearing aid manufacturer to discuss alternatives.

For other Medical Devices:

Please consult your physician and the device manufacturer to determine if operation of your phone may interfere with the operation of your medical device.

Export Administration Regulations

This product and its accessories might be covered by the Japan Export Administration Regulations ("Foreign Exchange and Foreign Trade Law" and its related laws). To export this product and its accessories, take the required measures on your responsibility and at your expenses. For details on the procedures, contact the Ministry of Economy, Trade and Industry.

Intellectual Property Right

Copyrights and Portrait Rights

You have no right to copy, modify, or distribute the contents such as text, images, music, or software programs downloaded from websites on the Internet, or images shot by the cameras of this product without permission from the copyright holder except for when the copy or quote is for personal use that is allowed by the copyright law.

Note that it may be prohibited to shoot or record live performances or exhibitions even for personal use. Make sure that you refrain from shooting portraits of other persons and distributing such portraits over the Internet without consent, as this violates portrait rights.

Trademarks

- “FOMA”, “i-mode”, “i-αppli”, “i-motion”, “Deco-mail”, “Chara-den”, “ToruCa”, “mopera”, “mopera U”, “WORLD CALL”, “DCMX”, “i-area”, “WORLD WING”, “OFFICEED”, “2in1”, “docomo PRIME series”, and the logos of “i-mode”, “i-αppli”, and “Music&Video Channel” are trademarks or registered trademarks of NTT DOCOMO, INC.
- “Catch Phone (Call waiting service)” is a registered trademark of Nippon Telegraph and Telephone Corporation.
- McAfee® is registered trademarks or trademarks of McAfee, Inc. and/or its affiliates in the US and/or other countries.
- Rovi, G-GUIDE, G-GUIDE MOBILE and G-Guide related logos are trademarks or registered trademarks of Rovi Corporation and/or its subsidiaries in Japan.
- QuickTime is a registered trademark of Apple Inc., in the US and other countries.
- Microsoft®, Windows®, Windows Media® and Windows Vista® are trademarks or registered trademarks of Microsoft Corporation in the United States and/or other countries.



- Powered by JBlend™ Copyright 2002-2011 Aplix Corporation. All rights reserved.
JBlend and JBlend-related trademarks are trademarks or registered trademarks of Aplix Corporation in Japan and other countries.
-  is a registered trademark of FeliCa Networks, Inc.
- microSDHC Logo is a trademark of SD-3C, LLC.





- “Multitask” is a registered trademark of NEC Corporation.
- “AXIS Font” is a trademark of AXIS Inc., and the “AXIS” font is a font developed by Type Project Inc.
- This product contains NetFront Browser, NetFront Document Viewer and NetFront Sync Client of ACCESS CO., LTD.
ACCESS, the ACCESS logo, and NetFront are registered trademarks or trademarks of ACCESS CO., LTD. in the United States, Japan and/or other countries.
Copyright © 2011 ACCESS CO., LTD. All rights reserved.

ACCESS™

NetFront™

- QR code is a registered trademark of Denso Wave Inc.
- Google and Google Map for Mobile are trademarks of Google Inc.
- Powered by Mascot Capsule®/Micro3D Edition™
Mascot Capsule® is a trademark of HI CORPORATION.
- “Blu-ray Disc” and “Blu-ray” are trademarks of the Blu-ray Disc Association.
- Wi-Fi and Wi-Fi CERTIFIED Logo are registered marks of the Wi-Fi Alliance.
- AirStation™ and AOSS™ are the trademark of BUFFALO INC.
- DLNA® is a trademark, a service mark, or a certification mark of the Digital Living Network Alliance.
- Other company names and product names described in the text are trademarks or registered trademarks of those companies.

Others

- This software is based in part on the work of the Independent JPEG Group.
- This product contains IrFront of ACCESS CO., LTD. IrFront is a registered trademark or trademark of ACCESS CO., LTD. in the United States, Japan and/or other countries.
- The IrDA® Feature Trademark is owned by the Infrared Data Association and used under license therefrom.
- Contains Adobe® Flash® Player, Adobe® Flash® Lite® and Adobe Reader®
 **Powered by ADOBE® FLASH®**
Mobile technology by Adobe Systems Incorporated.
Adobe Flash Player Copyright © 1996-2011 Adobe Systems Incorporated. All rights reserved.
Adobe Flash Lite Copyright © 2003-2011 Adobe Systems Incorporated. All rights reserved.
Adobe Reader Mobile Copyright © 1993-2011 Adobe Systems Incorporated. All rights reserved.
Adobe, Adobe Reader, Flash and Flash Lite are either registered trademarks or trademarks of Adobe Systems Incorporated in the United States and/or other countries.
- FeliCa is a contactless IC card technology developed by Sony Corporation. FeliCa is a registered trademark of Sony Corporation.
- “CROSS YOU” is a trademark of Sony Corporation.
- This product contains software licensed complying with GNU General Public License (GPL), GNU Lesser General Public License (LGPL), etc. For more details, see “GPL/LGPLライセンス説明” in “ mode” of “My document” under “Data box” from the Main Menu.
(The first part of “GPL/LGPLライセンス説明” is only available in Japanese.)
- iWnn of OMRON SOFTWARE Co., Ltd. is used for conversion methods for Japanese language.
- iWnn © OMRON SOFTWARE Co., Ltd. 2008-2011 All Rights Reserved.
- “Text Profiler” is trademark of OMRON Corporation.

- The Bluetooth® word mark and logos are owned by the Bluetooth SIG, INC. and any use of such marks by NTT DOCOMO, Inc. is under license. Other trademarks and trade names are those of their respective owners.
- MPEG Layer-3 audio coding technology licensed from Fraunhofer IIS and Thomson.
- This product is licensed under the MPEG-4 patent portfolio license, AVC patent portfolio license and VC-1 patent portfolio license for the personal use of a consumer or other uses in which it does not receive remuneration to
 - (i) encode video in compliance with the MPEG-4 Visual Standard, AVC Standard and VC-1 Standard (“MPEG-4/AVC/VC-1 Video”) and/or
 - (ii) decode MPEG-4/AVC/VC-1 Video that was encoded by a consumer engaged in a personal activity and/or was obtained from a video provider licensed to provide MPEG-4/AVC/VC-1 Video.No license is granted or shall be implied for any other use. Additional information may be obtained from MPEG LA, L.L.C. See <http://www.mpegla.com>.
- This product is manufactured or sold under license from InterDigital Technology Corporation.
- The abbreviations of operating systems (Japanese versions) below are used in this manual.
Windows 7 stands for Microsoft® Windows® 7 (Starter, Home Basic, Home Premium, Professional, Enterprise and Ultimate).
Windows Vista stands for Windows Vista® (Home Basic, Home Premium, Business, Enterprise and Ultimate).
Windows XP indicates the Microsoft® Windows® XP Professional operating system or Microsoft® Windows® XP Home Edition operating system.
- This product is protected by certain intellectual property rights of Microsoft Corporation and third parties. Use or distribution of such technology outside of this product is prohibited without a license from Microsoft or an authorized Microsoft subsidiary and third parties.
- This product is protected by certain intellectual property rights of Microsoft Corporation. Use or distribution of such technology outside of this product is prohibited without a license from Microsoft or an authorized Microsoft subsidiary.

- Content providers are using the digital rights management technology for Windows Media contained in this device (“WM-DRM”) to protect the integrity of their content (“Secure Content”) so that their intellectual property, including copyright, in such content is not misappropriated. This device uses WM-DRM Software to play Secure Content (“WM-DRM Software”). If the security of the WM-DRM Software in this device has been compromised, owners of Secure Content (“Secure Content Owners”) may request that Microsoft revoke the WM-DRM Software’s right to acquire new licenses to copy, display and/or play Secure Content. Revocation does not alter the WM-DRM Software’s ability to play unprotected content. A list of Revoked WM-DRM Software is sent to your device whenever you download a license for Secure Content from the Internet or from a PC. Microsoft may, in conjunction with such license, also download revocation lists onto your device on behalf of Secure Content Owners.
- The HMM-Based Speech Synthesis Engine embedded in this product uses the Simplified BSD License.

The HMM-Based Speech Synthesis System (HTS)
hts_engine API developed by HTS Working Group
<http://hts-engine.sourceforge.net/>

Copyright ©
2001-2010 Nagoya Institute of Technology, Department of Computer
Science
2001-2008 Tokyo Institute of Technology, Interdisciplinary Graduate
School of Science and Engineering
All rights reserved.

Redistribution and use in source and binary forms, with or without
modification, are permitted provided that the following conditions are met:

- Redistributions of source code must retain the above copyright notice, this list of conditions and the following disclaimer.
- Redistributions in binary form must reproduce the above copyright notice, this list of conditions and the following disclaimer in the documentation and/or other materials provided with the distribution.

- Neither the name of the HTS working group nor the names of its contributors may be used to endorse or promote products derived from this software without specific prior written permission.

THIS SOFTWARE IS PROVIDED BY THE COPYRIGHT HOLDERS AND CONTRIBUTORS “AS IS” AND ANY EXPRESS OR IMPLIED WARRANTIES, INCLUDING, BUT NOT LIMITED TO, THE IMPLIED WARRANTIES OF MERCHANTABILITY AND FITNESS FOR A PARTICULAR PURPOSE ARE DISCLAIMED. IN NO EVENT SHALL THE COPYRIGHT OWNER OR CONTRIBUTORS BE LIABLE FOR ANY DIRECT, INDIRECT, INCIDENTAL, SPECIAL, EXEMPLARY, OR CONSEQUENTIAL DAMAGES (INCLUDING, BUT NOT LIMITED TO, PROCUREMENT OF SUBSTITUTE GOODS OR SERVICES; LOSS OF USE, DATA, OR PROFITS; OR BUSINESS INTERRUPTION) HOWEVER CAUSED AND ON ANY THEORY OF LIABILITY, WHETHER IN CONTRACT, STRICT LIABILITY, OR TORT (INCLUDING NEGLIGENCE OR OTHERWISE) ARISING IN ANY WAY OUT OF THE USE OF THIS SOFTWARE, EVEN IF ADVISED OF THE POSSIBILITY OF SUCH DAMAGE.



A

AC adapter.....	20
Access point mode.....	85
After-sales service.....	96
Alarm.....	82
Antenna.....	5
Area mail.....	57
AUTO-GPS.....	66
Auto-key lock.....	43
Auto shutter.....	70
Auto-sort.....	56

B

Backlight.....	37
Bar code reader.....	83
Battery level.....	24
Battery pack	
Attaching/removing.....	19
Charging.....	20
Bluetooth function.....	84
Bookmark.....	62

C

Calendar.....	82
Call/charging indicator.....	4
Caller ID notification.....	23
Call forwarding service.....	50
Call rejection setting.....	44
Call waiting service.....	50

Camera.....	5, 67
Channel setting.....	72
Character entry.....	33
Line feed.....	33
Pictograms.....	33
Smiley.....	33
Symbols.....	33
Character size.....	38
Charging.....	20
Charging terminal.....	5
Check mail/message.....	56
Client mode.....	86
Closed lock setting.....	43
Connector terminal.....	4
Control key.....	30
Copyrights.....	113
Customize menu.....	31

D

Deco-mail.....	54
Decome-Anime.....	54
Desktop holder.....	21
Desktop icon.....	25
Dial lock.....	42
DIGA/DLNA link.....	87
Display.....	4, 24
DOCOMO connection manager.....	93

E

Early warning "Area Mail".....	57
Earphone.....	4
Earpiece.....	4
Earpiece volume.....	47
eco mode.....	39
eco mode autostart.....	40
eco mode setting.....	39
ECO NAVI.....	3, 25
Emergency call.....	51
English display.....	23
Export administration regulations.....	112

F

FeliCa.....	5, 80, 92
OsaiFu-Keitai.....	80
Finder display.....	67
Flash.....	5
FOMA antenna.....	5
Full browser.....	61
Function list.....	102

G

GPS.....	64
GPS antenna.....	5
GPS compatible i-appli.....	65
Guide.....	32

H	
Handwriting photo/memo	88
Holding.....	45
Home menu	31

I	
i- α ppli.....	77
IC card lock.....	42
iC communication	92
i-Channel.....	63
i-concier.....	81
Illumination setting	39
i-mode.....	60
i-mode fault diagnosis site.....	97
i-mode mail	53
Compose	53
Forward.....	55
Receive	55
Reply	55
Send.....	53
i-mode password.....	41
i-motion.....	79
Infrared communication	92
Infrared data port.....	4, 92
Initialize	44
Initial setting	22
Intellectual property right.....	113
International call	46
International roaming	52
i-Widget	77

K	
Keypad lock	43
Keypad sound.....	36
Kisekae tool	38
Koe-no-takuhaibin.....	46

L	
Light sensor	4
List of materials used	13
Location information	64
LUMIX Phone panel.....	5

M	
Machi-chara setting	38
Mail.....	53
Main menu	27
Main specifications	108
Making a call.....	45
Making a videophone call	45
Manner mode.....	36
Map application.....	65
Map/GPS	64
Menu icon	27
Microphone.....	4
microSD card	89
Back up/restore	92
Copy	91
Format.....	90
Inserting/removing.....	89
Motion control setting.....	25
Movie	79

MUSIC player.....	76
MUSIC player display	76
Music&Video channel.....	75

N	
Navi	65
Navigation displays	26
Network security code	41
Network services.....	49
Normal menu	31
Notification icon	25
Numeric keys	4

O	
Omakase choice.....	69
Omakase lock	43
Optical image stabilizer (O.I.S.).....	70
Options	101
Original.....	36
Original lock	43
Osaifu-Keitai	80
Out-of-service-area indication.....	24
Overseas use	52
Own number	23

P	
Part names and functions	4
PC backup	86
PC connection	93
Pedometer	88
Phonebook	58
Add to phonebook.....	58

Delete data.....	59	S	Timer recording	74
Edit phonebook	59	SAR	ToruCa.....	80
Search phonebook	45	Scanning function.....	Touch menu	31
Picture album.....	68	Schedule	Touch operation guide	31
Picture jump.....	69	Screen lock	Touch panel	4, 29
PIN1 code	41	Screen memo.....	Trademarks	113
PIN1 code entry set.....	42	Security codes.....	Troubleshooting.....	94
PIN2 code	41	Security codes.....	TV timer.....	74
PIN unblocking key (PUK).....	42	Security scan function (Scanning function).....	U	
Playing moving picture.....	68, 79, 87	Select language	UIM.....	20
Portrait rights.....	113	Select ring tone	Unoperated lock setting.....	43
Position location.....	65	Shooting moving pictures	Update (Pattern data).....	100
Power on/off	22	Shooting still images	V	
Power saver mode	37	Simple menu.....	Vibrator setting	35
Profile.....	23	Site access	Video	74
Public mode (Drive mode).....	48	Slide lever	Video recording	73
Public mode (Power off).....	48	SMS.....	View blind	37
Q		Compose	Viewer display.....	73
QR code	83	Receive	Viewing still images.....	68
R		Software update	Voice mail service.....	50
Radio waves reception level	24	Speaker	W	
Received calls	46	Specific absorption rate.....	Warranty.....	96
Receiving a call	47	Speed selector	Wi-Fi.....	85
Receiving a videophone call	47	Stand-by display	WORLD CALL	46
Record message	47	Start by voice.....	WORLD WING.....	52
Redial	46	Status icon.....	Numerics	
Reset settings.....	44	Strap hole	1Seg	71
Ring volume.....	35	Submenu.....	1Seg antenna.....	5
T		T		
Terminal security code	41	Terminal security code		41

Access the following for checking or changing the contents of your contract, or for applying to respective services, and asking for related documents:

From i-mode

i Menu ▶ お客様サポート (User support) ▶ お申込・お手続き (Applications/Procedures)

▶ 各種お申込・お手続き (Respective applications/procedures)

Packet communication charges free

From PC

My docomo (<http://www.mydocomo.com/>) ▶ 各種お申込・お手続き

- “お客様サポート (User support)” and My docomo are available in Japanese only.
- You will need your “Network Security Code” for the access from i-mode.
- No packet communication charges are incurred for the access from i-mode. Accessing from overseas will incur charges.
- You will need your “docomo ID/password” for the access from a PC.
- If you do not have or you have forgotten your “Network Security Code” or “docomo ID/password”, contact “General Inquiries” listed on the back page of this manual.
- You may not be able to access the site depending on the details of your subscription.
- You may not be able to access the site due to system maintenance, etc.



Using mobile phone with your manners!

When using your mobile phone in a public place, don't forget to show common courtesy and consideration for others around you.

In the following cases, be certain to turn off the power.

■ Where use is prohibited

- Be sure to turn off the power of your mobile phone in airplanes, in hospitals and around priority seat in a train, etc.

In the following cases, be certain to set Public mode.

■ While driving

- Using the mobile phone in your hand while driving is subject to punishment. This does not apply in unavoidable circumstances when, for instance, responding to someone who is sick, injured or when maintaining public order.

■ When in theaters, movie theaters, museums, and similar venues

Respect the privacy.



Please be considerate of the privacy of individuals around you when shooting and sending photos using camera-equipped mobile phones.



An Environment Protection Program by DOCOMO

Simplified Version of the Manual

We have edited the traditional instruction manual to simplify the descriptions of basic operational procedures for respective functions. As a result, we have succeeded to reduce the consumption of paper used.

For the functions frequently used and more detailed descriptions, you can refer to “使いかたガイド (Guide)” (in Japanese only) that comes with the FOMA terminal and the DOCOMO website.

Collection and Recycling of Mobile Phones



モバイルリサイクルネットワーク
携帯電話の回収/リサイクル

To carry out the protection of environment and the reuse of precious resources, we at mobile phone and PHS carriers collect your disused mobile phones, batteries, or chargers for recycling to a shop having this mark, regardless of brand names or makers.

Kindly take your disused ones to a docomo Shop nearby.

**Loss or theft of FOMA terminal or
payment of cumulative cost overseas**
<docomo Information Center>

(available 24 hours a day)

■ **From DOCOMO mobile phones**

International call access code
for the country you stay at **-81-3-6832-6600*** (toll free)

*You are charged a call fee to Japan when calling from a land-line phone, etc.

※ If you use P-05C, you should dial the number +81-3-6832-6600
(to enter "+", press and hold the "0" key for at least one second).

■ **From land-line phones**

<Universal number>

Universal number
international prefix **-8000120-0151***

*You might be charged a domestic call fee according to the call rate for the country you stay at.

※ For international call access codes for major countries and universal number international prefix, refer to the DOCOMO International Services website.

- If you lose your FOMA terminal or have it stolen, immediately take the steps necessary for suspending the use of the FOMA terminal.
- If the FOMA terminal you purchased is damaged, bring your FOMA terminal to a repair counter specified by DOCOMO after returning to Japan.

Failures encountered overseas
<Network Support and Operation Center>

(available 24 hours a day)

■ **From DOCOMO mobile phones**

International call access code
for the country you stay at **-81-3-6718-1414*** (toll free)

*You are charged a call fee to Japan when calling from a land-line phone, etc.

※ If you use P-05C, you should dial the number +81-3-6718-1414
(to enter "+", press and hold the "0" key for at least one second).

■ **From land-line phones**

<Universal number>

Universal number
international prefix **-8005931-8600***

*You might be charged a domestic call fee according to the call rate for the country you stay at.

※ For international call access codes for major countries and universal number international prefix, refer to the DOCOMO International Services website.

General Inquiries <docomo Information Center>

 **0120-005-250 (toll free)**

* Service available in English, Portuguese, Chinese, Spanish, and Korean.
* Unavailable from part of IP phones.
(Business hours: 9:00 a.m. to 8:00 p.m.)

■ **From DOCOMO mobile phones** ■ **From land-line phones**
(In Japanese only) (In Japanese only)

 **(No prefix) 151 (toll free)**  **0120-800-000 (toll free)**

* Unavailable from land-line phones, etc. * Unavailable from part of IP phones.

(Business hours: 9:00 a.m. to 8:00 p.m. (open all year round))

● Please confirm the phone number before you dial.

● For Applications or Repairs and After-Sales Service, please contact the above-mentioned information center or the docomo Shop etc. near you on the NTT DOCOMO website or the i-mode site.

NTT DOCOMO website <http://www.nttdocomo.co.jp/english/>

i-mode site i Menu ▶ **お客様サポート (User support)** ▶ **ドコモショップ (docomo Shop)** (In Japanese only)

Repairs

■ **From DOCOMO mobile phones** ■ **From land-line phones**
(In Japanese only) (In Japanese only)

 **(No prefix) 113 (toll free)**  **0120-800-000 (toll free)**

* Unavailable from land-line phones, etc. * Unavailable from part of IP phones.

(Business hours: 24 hours (open all year round))



Don't forget your mobile phone ... or your manners!

When using your mobile phone in a public place, don't forget to show common courtesy and consideration for others around you.

Sales: NTT DOCOMO, INC.

Manufacturer: Panasonic Mobile Communications Co., Ltd.



Li-ion 00

To prevent damage to the environment,
bring used battery packs to a docomo
service counter, a docomo agent or a
recycle center.

July '11 (Edition 1.1)

3TR100373AAA

F0511-1

P-05C

Manual for PC Connection

Data Communication Available from FOMA Terminal	1
Before Using Data Communication	2
Setup Flow for Data Transfer (OBEX™ Communication)	4
Setup Flow for Data Communication	4
Installing FOMA Communication Configuration File (Driver)	6
Preparing Bluetooth Communication	10
Preparing Wi-Fi Communication	12
DOCOMO Connection Manager	14
Before Installing DOCOMO Connection Manager	15
Installing DOCOMO Connection Manager	16
Starting DOCOMO Connection Manager	18
Setting Dial-up Network	19
Making Dial-up Connection	33
AT Command	37
AT Command List	38

About Manual for PC Connection

This manual gives you the explanations of details required for having data communication with your P-05C, and installing "FOMA communication configuration file"/"DOCOMO Connection Manager" on your personal computer assuming that you are using the one that comes with Windows 7.

Some procedures and displays may differ depending on your operating environment.

Data Communication Available from FOMA Terminal

The data communication services you can use by connecting the FOMA terminal to a personal computer are classified as data transfer (OBEX™ communication), packet communication, and 64K data communication. The FOMA terminal is equipped with the adapter function for packet communication.

- To perform the packet communication overseas, perform it via the IP connection. (You cannot perform the packet communication via the PPP connection.)
- 64K data communication is not available overseas.

Data Transfer (OBEX™ Communication)

You can exchange data files such as images, melody files, Phonebook entries and mail messages with another FOMA terminal or a personal computer.

- The data files you can exchange vary depending on the transfer methods. For details, confirm each transfer method.

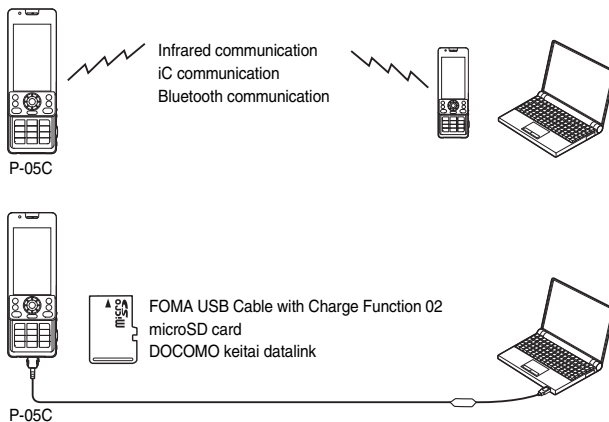

Packet Communication

This communication system requires a communication fee according to the amount of data you sent and received. (Best effort system with 7.2 Mbps of maximum download speed and 2.0 Mbps of maximum upload speed)※ It uses an access point which supports FOMA packet communication such as DOCOMO Internet access service “mopera U”.

Packet communication is available by configuring various settings after connecting the FOMA terminal to a personal computer via the FOMA USB Cable with Charge Function 02 (option), Bluetooth communication or Wi-Fi communication, and is suitable for using applications which require the high-speed communication.

To carry out the settings and connection, see page 4 and after.

※ The maximum speed is based on the technical specification. The actual communication speed varies depending on the network congestion state and the communication environment. The communication speed might be lowered when you connect the FOMA terminal to an access point which does not support HIGH-SPEED or the terminal is outside the FOMA High-Speed Area, or when you use the device which does not support High-Speed such as DOCOMO's PDA “sigmarion III”.

- The packet communication is charged according to the amount of data you sent and received. Note that you are charged a high communication fee for the massive data communication such as browsing Internet websites having many images or downloading data files.

64K Data Communication

This communication system requires a communication fee according to the duration of connection. By connecting the FOMA terminal to a personal computer via the FOMA USB Cable with Charge Function 02 (option) or Bluetooth communication, you can execute communication.

It uses an access point which supports FOMA 64K data communication such as DOCOMO Internet access service “mopera U”, or an ISDN-synchronous 64K access point. To carry out the settings and connection, see page 4 and after.

- The 64K data communication is charged according to the duration of connection. Note that a communication fee becomes expensive if you use this service for a long time.

Information

- The FOMA terminal does not support Remote Wakeup.
- The FOMA terminal does not support the FAX communication.
- You can perform data communications by connecting the FOMA terminal with DOCOMO's PDA "sigmarion III".
- When you perform data communication by using Bluetooth function, the high speed communication is applied to the FOMA terminal. However, you may not be able to communicate at the maximum speed, because of the limit of communication speed of Bluetooth function.

Before Using Data Communication

Charge of Internet service provider

To use the Internet, you need to pay the charge for the Internet service provider you use. Besides the FOMA service fee, you need to directly pay this charge to the Internet service provider. For details on the charge, contact the Internet service provider you use.

You can use the DOCOMO Internet access service, "mopera U". To use "mopera U", subscription (charged) is required.

Setting access point (Internet service provider, etc.)

The access points for the packet communication and 64K data communication differ. To use the packet communication, connect to an access point which supports packet communication. To use the 64K data communication, connect to an access point which supports FOMA 64K data communication or ISDN-synchronous 64K.

- You cannot connect to the DoPa access point.
- For the service contents and connection method of "mopera", refer to the "mopera" website (in Japanese only):
<http://www.mopera.net/mopera/index.html>

About user authentication for accessing network

User authentication (ID and password) may be required at connection to some access points. In that case, enter your ID and password on the communication software (dial-up network). ID and password are specified by the Internet service provider or network administrator of the access point. For details, contact the provider or network administrator.

About access authentication for using browser

To use the FirstPass supporting site from a browser on your personal computer, you need to have FirstPass (user certificate) for access to authentication. Download the FirstPass PC software from the DOCOMO website, and then install it and establish the settings on your personal computer. For details, refer to the DOCOMO website.

Conditions of packet communication and 64K data communication

To carry out the communication using the FOMA terminal in Japan, the following conditions are required:

- The personal computer to be used can use the FOMA USB Cable with Charge Function 02 (option).
- When connecting using Bluetooth communication, the personal computer should support Dial-up Networking Profile of Bluetooth Specification Ver. 1.1, Ver. 1.2 or Ver. 2.0+EDR.
- When using Wi-Fi communication, the personal computer should support Wireless LAN Specification IEEE802.11b/g.
- The PDA to be used should support FOMA packet communication and 64K data communication.
- Within the FOMA service area
- For packet communication, the access point should support packet communication of the FOMA.
- For 64K data communication, the access point should support the FOMA 64K data communication or ISDN-synchronous 64K.

Even when these conditions are satisfied, if the base station is congested or the radio wave conditions are bad, you may not carry out the communication.

Operating Environment

For the data communication, the following operating environment is required for your personal computer:

Item	Necessary Environment
PC main unit	PC/AT compatible model When using the FOMA USB Cable with Charge Function 02 (option): USB port (Universal Serial Bus Specification Rev1.1/2.0 compliant) When using Bluetooth communication: Bluetooth Specification Ver. 1.1, Ver. 1.2 or Ver. 2.0+EDR compliant (Dial-up Networking Profile) When using Wi-Fi communication: Wireless LAN Specification IEEE802.11b/g compliant Display resolution 800 x 600 dots, high color 16 bits or more recommended. ●For DOCOMO Connection Manager, display resolution 1024 x 600 dots or more (1024 x 768 dots or more recommended)
OS	Windows 7 32-bit version/64-bit version (Japanese version) Windows Vista 32-bit version/64-bit version (Japanese version) Windows XP (Japanese version)
Memory requirements	Windows 7 32-bit version: 1 Gbyte or more Windows 7 64-bit version: 2 Gbytes or more Windows Vista: 512 Mbytes or more Windows XP: 128 Mbytes or more (Japanese version in each)
Hard disk space size	Unused memory space of 5 Mbytes or more ●Unused memory space of 10 Mbytes or more for DOCOMO Connection Manager

- The following operating environment is required for DOCOMO Connection Manager:
 Web-browsing software: Internet Explorer 6.0 or later
 E-mail software: Windows Mail or Outlook Express 6.0
- For the latest information about the operating environment, refer to the DOCOMO website.
- The operation in the added/changed operating environment and on the upgraded OS is not guaranteed.
- The memory requirements and hard disk space size may vary depending on the system environment.

Necessary Devices

The following hardware and software are required besides the FOMA terminal and personal computer:

- FOMA USB Cable with Charge Function 02 (option) or FOMA USB Cable (option)^{※1}
- “FOMA communication configuration file” (driver)^{※2}

^{※1} For USB connection

^{※2} Download the FOMA communication configuration file from the DOCOMO website.

Information

- Use a dedicated FOMA USB Cable with Charge Function 02 or FOMA USB Cable. The USB cable for personal computers cannot be used because the shape of the connector differs.
- If you use a USB hub, the devices may not work correctly.

Setup Flow for Data Transfer (OBEX™ Communication)

When you use the FOMA USB Cable with Charge Function 02 (option), install the FOMA communication configuration file.

Install the "FOMA communication configuration file" (driver). (See page 6)

- Download the FOMA communication configuration file from the DOCOMO website and install.

Data transfer

Setup Flow for Data Communication

The following outline shows a setup flow for packet communication or 64K data communication.

For USB connection

Install the "FOMA communication configuration file" (driver). (P.6)

- Download the FOMA communication configuration file from the DOCOMO website and install.

Connect a personal computer to the FOMA terminal using the FOMA USB Cable with Charge Function 02 (option).

Check the setting after installation. (P.7)

Download "DOCOMO Connection Manager" from the DOCOMO website and install. (P.15)

For Bluetooth connection

Connect a personal computer wirelessly to the FOMA terminal using Bluetooth communication. (P.10)

Check the modem. (P.11)

Carry out the setting manually without using "DOCOMO Connection Manager". (P.19, P.36)

Connect. (P.18, P.33)

For Wi-Fi connection (Packet communication only)

Set the FOMA terminal to Access point mode. (P.12)

Set up the connection. (P.12)

Connect.

Connecting PC and the FOMA Terminal

The following steps explain how to connect the FOMA USB Cable with Charge Function 02 (option).

- 1 Check the direction of the connector terminal of the FOMA terminal, then straight insert the external connector of the FOMA USB Cable with Charge Function 02 until it clicks.

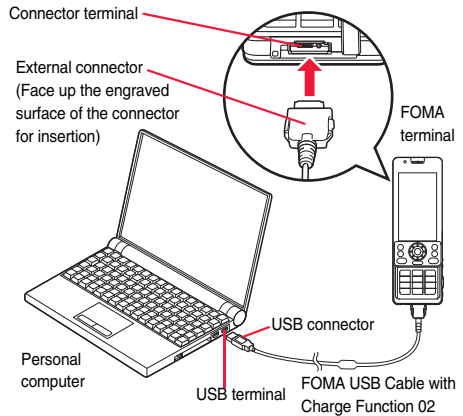

- 2 Connect the USB connector of the FOMA USB Cable with Charge Function 02 to the USB terminal of the personal computer.

Information

- Set "USB mode" to "Communication mode" for data communication.
Operate **[MENU]** ▶ **Setting** ▶ **External connection** ▶ **USB mode** ▶ **Communication mode**.
- Do not forcibly insert the FOMA USB Cable with Charge Function 02. Malfunction may result. Insert each connector in the correct direction at the correct angle; otherwise, you will fail connection. When the direction and angle are correct, you can insert a connector smoothly without the strong force. If you fail to insert a connector, check its shape and direction once more without inserting a connector forcibly.
- Use a dedicated FOMA USB Cable with Charge Function 02. (The USB cable for personal computers cannot be used because the shape of the connector differs.)
- Symbol "Ⓜ" appears on the FOMA terminal when the FOMA terminal recognizes the connection with the personal computer after you install the FOMA communication configuration file (driver) for packet communication or 64K data communication. Before you install the FOMA communication configuration file (driver), the FOMA terminal does not recognize the connection with the personal computer, and symbol "Ⓜ" does not appear.

Removing

1. While holding down the release buttons of the external connector of the FOMA USB Cable with Charge Function 02, straight pull out the connector.
2. Pull out the FOMA USB Cable with Charge Function 02 from the USB terminal of the personal computer.

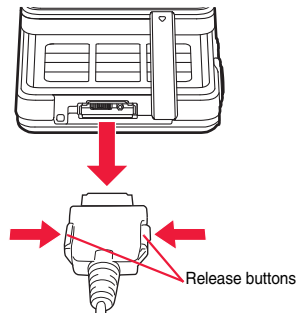

Information

- Do not disconnect the FOMA USB Cable with Charge Function 02 forcibly. Malfunction may result.
- Do not disconnect the FOMA USB Cable with Charge Function 02 during data communication. Erroneous operation or malfunction of the personal computer or FOMA terminal, or loss of data could result.
- Do not connect/disconnect the FOMA USB Cable with Charge Function 02 in succession. Once you connect the cable, wait for a while, then disconnect it and vice versa.

Installing FOMA Communication Configuration File (Driver)

Installing the FOMA communication configuration file (driver) is required when you connect the FOMA terminal to your personal computer via the FOMA USB Cable with Charge Function 02 (option) for the first time.

- When connecting wirelessly using Bluetooth communication or Wi-Fi communication, you do not need to install the FOMA communication configuration file (driver).
- Operate as the user who has the PC administrator right.
- End all the programs resident on your personal computer before installing the FOMA communication configuration file (driver).

- 1** Download the FOMA communication configuration file (driver) from the DOCOMO website.
- 2** Double-click “exe” file of the downloaded FOMA communication configuration file (driver) to execute. Decompress it into the desired folder.
- 3** Double-click “P05C_ins.exe” in the decompressed folder, and click “はい (Yes)”.
 - For Windows Vista, click “続行 (Continue)” instead of “はい (Yes)”.
 - For Windows XP, the user account control display does not appear.
- 4** Click “OK”.

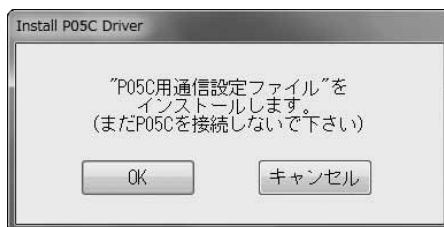

- 5** Turn on the FOMA terminal’s power, then connect the FOMA terminal to the personal computer using the FOMA USB Cable with Charge Function 02. (See page 5)

Installation starts.

- 6** Click “OK”.

After the installation of all the “FOMA communication configuration files” (driver) is completed, a pop-up message “デバイスを使用する準備ができました。デバイス ドライバソフトウェアが正しくインストールされました。(The system is ready to use the device. The device driver software was installed correctly.)” appears for a few seconds from the indicator on the task bar.

Confirm Installed FOMA Communication Configuration File (Driver)

Confirm that the “FOMA communication configuration file” (driver) is installed correctly.

For Windows 7

- 1 “ [スタート (Start)]”
▶ Open “デバイスとプリンター (Devices and printers)”.
- 2 Open “docomo PRIME series P-05C”
▶ Click the “ハードウェア (Hardware)” tab.
- 3 Confirm the installed driver names.

Confirm that all driver names are displayed.

- The COM port number varies depending on the personal computer you use.

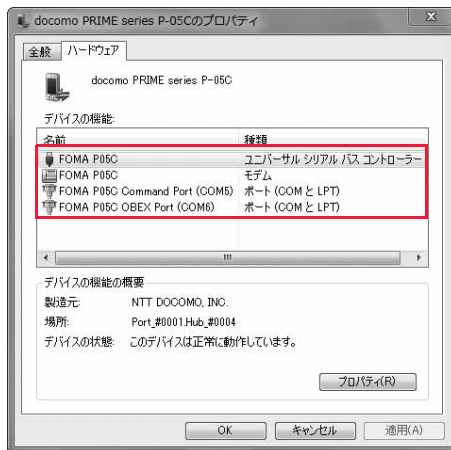

For Windows Vista, Windows XP

- 1 “ [スタート (Start)]” ▶ Open “コントロールパネル (Control panel)”
▶ Open “システムとメンテナンス (System and maintenance)”.

<For Windows XP>

“スタート (Start)” → Open “コントロールパネル (Control panel)”

→ “パフォーマンスとメンテナンス (Performance and maintenance)” → Open “システム (System)”.

- 2 Open “ハードウェアとデバイスを表示 (Show hardware and devices)”
▶ Click “続行 (Continue)”.

<For Windows XP>

Click the “ハードウェア (Hardware)” tab → Click “デバイスマネージャ (Device manager)”.

3 Click each device, then confirm the installed FOMA communication configuration file (driver) names.

Confirm that all FOMA communication configuration file (driver) names are displayed under “ポート (COMとLPT)” [Port (COM/LPT)], “モデム (Modem)”, and “ユニバーサル シリアル バス コントローラ (Universal serial bus controller)”.

- The COM port number varies depending on your personal computer.

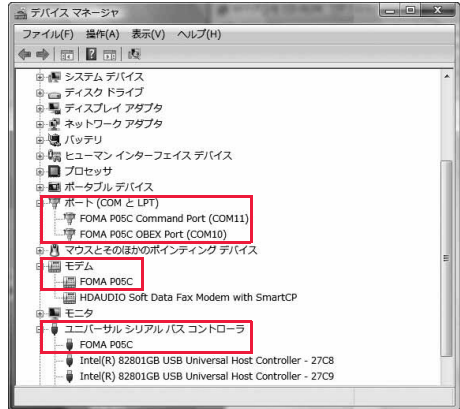

The following drivers are installed by installation of the “FOMA communication configuration file” (driver):

Device name	FOMA communication configuration file (driver) name
ポート (COMとLPT) [Port (COM/LPT)]	<ul style="list-style-type: none"> ・ FOMA P05C Command Port ・ FOMA P05C OBEX Port
モデム (Modem)	<ul style="list-style-type: none"> ・ FOMA P05C
<For Windows 7, Windows Vista> ユニバーサル シリアル バス コントローラ (Universal serial bus controller) <For Windows XP> USB (Universal Serial Bus) コントローラ [USB (Universal Serial Bus) controller]	<ul style="list-style-type: none"> ・ FOMA P05C

Uninstall FOMA Communication Configuration File (Driver)

When uninstalling the “FOMA communication configuration file” (driver) is necessary (such as when upgrading the version), perform the operation below.

● Operate as the user who has the PC administrator right.

1 If the FOMA terminal is connected to a personal computer via the FOMA USB Cable with Charge Function 02 (option), disconnect the FOMA USB Cable with Charge Function 02.

2 “ [スタート (Start)]” ▶ Open “コントロールパネル (Control panel)”
▶ Open “プログラムのアンインストール (Uninstall programs)”.

<For Windows XP>

“スタート (Start)” → Open “コントロールパネル (Control panel)” → Open “プログラムの追加と削除 (Add and delete programs)”.

3 Select “FOMA P05C USB” and click “アンインストールと変更 (Uninstall and change)”.

<For Windows Vista>

When the user account control display appears after step 3, click “続行 (Continue)”.

<For Windows XP>

Select “FOMA P05C USB” and click “変更と削除 (Change and delete)”.

4 Click “OK”.

5 Click “はい (Yes)” to restart Windows.

The uninstallation is then completed.

● If you click “いいえ (No)”, restart Windows manually.

Information

- If you remove the FOMA USB Cable with Charge Function 02 from the personal computer or click the “キャンセル (Cancel)” button to stop installation while installing the “FOMA communication configuration file” (driver), the “FOMA communication configuration file” (driver) may not be installed correctly. In that case, execute “P05C_un.exe” in the folder decompressed in step 2 on page 6 to delete the “FOMA communication configuration file” (driver), and then install the files again.

Preparing Bluetooth Communication

You can make data communication by connecting a Bluetooth communication compatible personal computer wirelessly to your FOMA terminal.

Connect to Personal Computer for the First Time

To connect a personal computer to the FOMA terminal for the first time, register the personal computer to the FOMA terminal.

1 (MENU) ▶ Tool ▶ Bluetooth ▶ Accept dialup devices

- You can set "Accept dialup devices" also by (MENU) ▶ Setting ▶ External connection ▶ Bluetooth ▶ Accept dialup devices.
- To cancel, press (C) (Cancel) in standby. When no connection is made for five minutes in standby, the connection is automatically released.
- During standby, "Ⓜ (blue)" lights.

2 Search and register the Bluetooth device from the personal computer.

- Register the device from the personal computer while the FOMA terminal is in standby.
- Refer to the operating manual of your personal computer for the details of how to operate it. (Depending on your personal computer, "探索 (search)" or "サーチ (search)" is used instead of "検索 (search)", and "ペアリング (pairing)" is used instead of "機器登録 (register devices)".

3 When the display for connection request appears, select "YES".

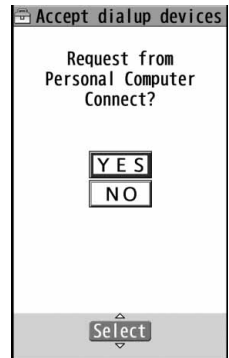

4 Enter the Bluetooth pass key.

- You can enter 4 through 16 half-pitch alphanumeric characters for the Bluetooth pass key.
- Enter the same Bluetooth pass key for both the FOMA terminal and personal computer.

5 The personal computer is registered and a wireless connection starts.

When the connection is completed, "Ⓜ (blue)" blinks.

Information

- You cannot place the devices using the Headset service or Hands-free service in the state of "Accept registered" while the FOMA terminal is in the state of "Accept dialup devices".
- When the personal computer found multiple devices for registering the FOMA terminal on the personal computer, identify the FOMA terminal by the device name. When the personal computer found multiple devices having the same device names, identify the FOMA terminal by the device address.
- In the state of "Accept dialup devices", searches are made from all the Bluetooth devices around, however, you cannot connect to any service other than the Dial-up Communication service.

■ To connect to the registered personal computer

When you connect to the FOMA terminal from a registered personal computer, place "Dial-up" in the state of "Accept registered". Then you can make a connection from the personal computer to the FOMA terminal by operating from the personal computer. You can connect even in the state of "Accept dialup devices".

Confirm the Modem

Before setting communication, confirm the name and COM port number of the modem used for connecting the dial-up service.

For Windows 7



- 1 “ [スタート (Start)]”
▶ Open “デバイスとプリンター (Devices and printers)”.
- 2 Open “P05C” ▶ Click the “ハードウェア (Hardware)” tab.
- 3 Confirm the modem name or COM port number.

For Windows Vista, Windows XP

- 1 “ [スタート (Start)]” ▶ Open “コントロールパネル (Control panel)”
▶ Open “システムとメンテナンス (System and maintenance)”.
<For Windows XP>
“スタート (Start)” → Open “コントロールパネル (Control panel)”
→ “パフォーマンスとメンテナンス (Performance and maintenance)” → Open “システム (System)”.
- 2 Open “ハードウェアとデバイスを表示 (Show hardwares and devices)”
▶ Click “続行 (Continue)”.
<For Windows XP>
Click the “ハードウェア (Hardware)” tab → Click “デバイスマネージャ (Device manager)”.
- 3 Click each device, then confirm the modem name or COM port number.
The modem name or COM port number is displayed under “ポート (COMとLPT) [Port (COM/LPT)]” and “モデム (Modem)”.

Have Dial-up Communication Service Closed



You can close the Dial-up Communication service that is connected.

- 1  ▶ Tool ▶ Bluetooth ▶ Device list
• You can display the Device list also by  ▶ Setting ▶ External connection ▶ Bluetooth ▶ Device list.
- 2 Select the Bluetooth device that is connected.
- 3 Dial-up ▶ YES
The Dial-up Communication service is closed.

Preparing Wi-Fi Communication

You can make packet communication by connecting a Wi-Fi compatible personal computer to your FOMA terminal via Wi-Fi.

Set the FOMA Terminal to Access Point Mode

- 1 **(MENU) ▶ Tool ▶ Wi-Fi ▶ Access point mode ▶ Start connecting**
 - You can start Access point mode also by **(MENU) ▶ Setting ▶ External connection ▶ Wi-Fi ▶ Access point mode ▶ Start connecting.**
 - When Access point mode starts, “).
- 2 Press **( TV) (Check)** to confirm the settings in Access point mode for the FOMA terminal.

Connection Setting for Personal Computer

For Windows 7

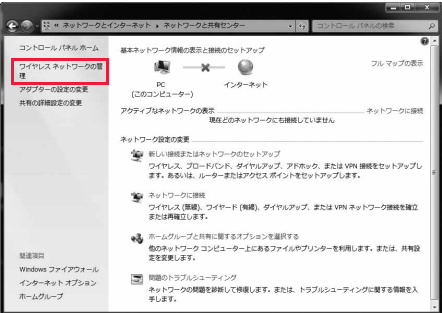
- 1 “ [スタート (Start)]”
 - ▶ Open “**コントロールパネル (Control panel)**”
 - ▶ Click “**ネットワークとインターネット (Network and internet)**”.
 - 2 Click “**ネットワークと共有センター (Network and sharing center)**”.
 - 3 Click “**ワイヤレスネットワークの管理 (Wireless network management)**”.
- 
- The screenshot shows the Windows 7 Network and Sharing Center window. The left sidebar has a red box around 'ワイヤレスネットワークの管理' (Wireless network management). The main content area shows 'ネットワークと共有センター' (Network and Sharing Center) with a status bar indicating '現在のネットワークに接続していません' (Not connected to the current network). Below this, there are sections for 'ネットワーク設定の変更' (Change network settings) and 'ネットワークの接続' (Network connections), with 'ワイヤレス (無線)' (Wireless) selected.
- 4 Click “**追加 (Add)**”.
 - 5 Click “**ネットワークプロファイルを手動で作成します (Set up the network profile manually)**”.

6 Enter ESSID for the FOMA terminal in the “ネットワーク名 (Network name)” column, set the security type for the FOMA terminal in the “セキュリティの種類 (Security type)” column, and click “次へ (Next)”.

- “WPA2-パーソナル (WPA2-personal)” under “セキュリティの種類 (Security type)” has the same meaning of “WPA2-PSK”.
- If the security is set to the FOMA terminal, set “暗号化の種類 (Encryption type)” and “セキュリティキー (Security key)” options to the same settings as the FOMA terminal.

7 Click “閉じる (Close)”.

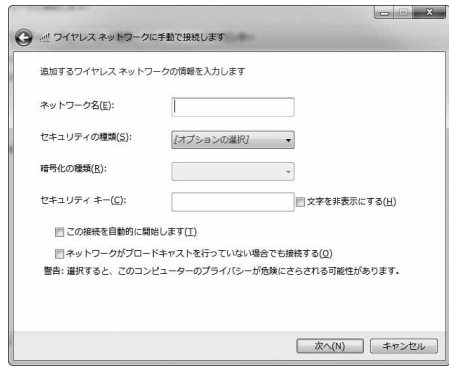

DOCOMO Connection Manager

“DOCOMO Connection Manager” is a convenient software program to perform flat-rate data communication and volume charging data communication. It enables you to sign up for “mopera U” and easily make PC settings according to your contract situation. It also enables you to check the estimate data traffic and usage amount with the charge counter function.

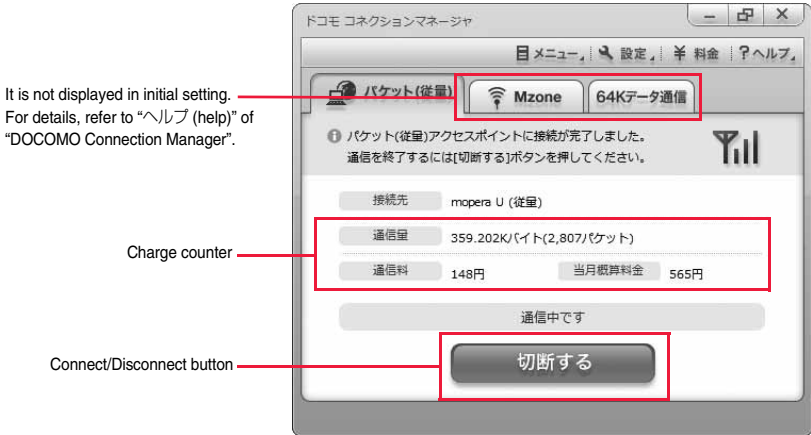

This manual explains how to install “DOCOMO Connection Manager”.

To access the Internet by using a terminal, you need to contract with a Internet service provider (such as “mopera U”) which supports the service and data communication.

For details, refer to the DOCOMO website.

■When Using Volume Charging Data Communication (including i-mode packet flat-rate service, etc.)

Note that a communication fee might become expensive when you transfer a large amount of data such as by browsing websites having many images, or by downloading data (such as application, music/movie data, updating of OS/Anti-virus software). When you perform data communication by connecting this FOMA terminal to your personal computer via the USB cable, note that the communication is not covered by the flat-rate service of “Pake-hodai” and “Pake-hodai full”.

■When Using Flat-Rate Data Plan

To use the flat-rate data plan, you need to apply for a billing plan which supports flat-rate data communication and sign a contract with the Internet service provider. For details, refer to the DOCOMO website.

■When Using “mopera”

For details on method of connection and setting, refer to the “mopera” website (in Japanese only):

<http://www.mopera.net/mopera/support/index.html>

Before Installing DOCOMO Connection Manager

Installation Flow

STEP

1 Prepare the FOMA terminal and the FOMA USB Cable with Charge Function 02 (option) or the FOMA USB Cable (option).

STEP

2 Check the service contents and the contract contents with Internet service provider.

STEP

3 When a connection software program other than “DOCOMO Connection Manager” is installed, set it not to start automatically.

• See page 15 for using communication software other than “DOCOMO Connection Manager”.

■About Internet Explorer Settings

Before using this software program, make the setting on the “接続 (Connection)” tab of “インターネットオプション (Internet option)” of Internet Explorer to “ダイヤルしない (Not to dial)”.

1. Start Internet Explorer, and select “ツール (Tool)”
→ “インターネットオプション (Internet option)”.
2. Select the “接続 (Connection)” tab and select “ダイヤルしない (Not to dial)”.
3. Click “OK”.



Information

<Use of connection software other than “DOCOMO Connection Manager”>

• You do not simultaneously need following software programs as this software program includes the functions equivalent to them.

Uninstall or set them not to start depending on your needs.

※ Software programs you do not need to use simultaneously

- ・mopera Uかんたんスタート (mopera U start up tool)
- ・Uかんたん接続設定ソフト (mopera U connection & setting tool)
- ・FOMA PC設定ソフト (FOMA PC configuration software)
- ・FOMAバイトカウンタ (FOMA byte counter)

When you use Mzone (DOCOMO public wireless LAN service) with this software program, uninstall the following public wireless LAN connection software programs.

※ You cannot use Mzone when they are simultaneously installed:

- ・U公衆無線LANユーティリティソフト (U public wireless LAN utility software)
- ・ドコモ公衆無線LANユーティリティソフト (DOCOMO public wireless LAN utility software)
- ・ドコモ公衆無線LANユーティリティプログラム (DOCOMO public wireless LAN utility program)

Installing DOCOMO Connection Manager

To connect the FOMA terminal to a personal computer and perform the packet communication or 64K data communication, you need to configure various settings related to the communication.

Using “DOCOMO Connection Manager”, you can easily set up dial-up, communication setup optimization, and access point name (APN).

- Operate as the user who has the PC administrator right.
- End all the running application programs.

End the programs resident on Windows including anti-virus software.

(Example) Right click the icon appears on the task tray, and select “閉じる (Close)” or “終了 (Exit)”

1 Download “DOCOMO Connection Manager” from the DOCOMO website.

http://www.nttdocomo.co.jp/support/utilization/application/service/connection_manager/ (In Japanese only)

2 Double-click downloaded “dcm_connect_mng_setup.exe” to execute, and click “はい (Yes)”.

- For Windows Vista, you click “続行 (Continue)” instead of “はい (Yes)”.
- For Windows XP, the user account control display does not appear.

When MSXML6 and Wireless LAN API are not installed on the Windows XP environment, you need to install them before installing “DOCOMO Connection Manager”. When a confirmation display appears, click “Install” and install MSXML6/Wireless LAN API. When you restart Windows after installation of MSXML6/Wireless LAN API is completed, installation of “DOCOMO Connection Manager” automatically starts.

3 Click “次へ (Next)”.

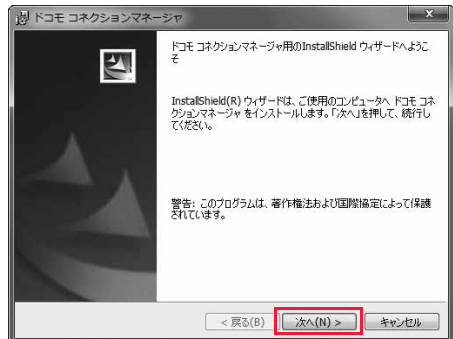

4 Confirm the display precautions and click “次へ (Next)”.

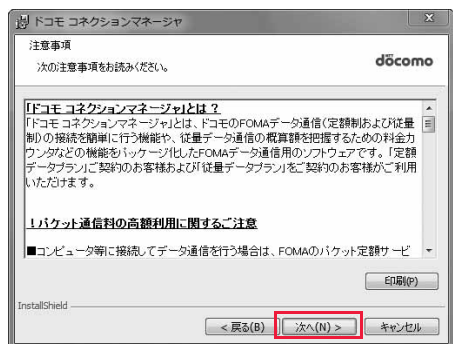

- 5** Confirm the licensing contract contents. If you agree with the contents, select “使用許諾契約の条項に同意します (Agree with the licensing contract contents)” and click “次へ (Next)”.

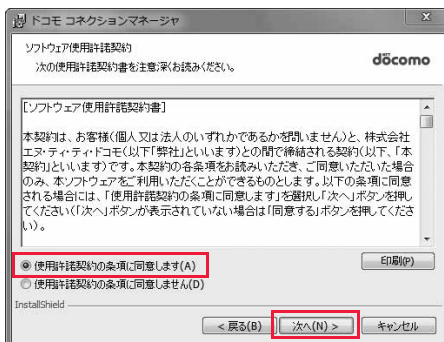

- 6** Confirm the installation destination folder, then click “次へ (Next)”.

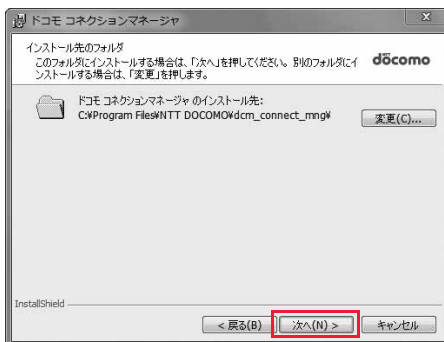

- 7** Click “インストール (Install)”.
Installation starts.



- 8** Click “完了 (Finish)”.
Installation is completed.



Starting DOCOMO Connection Manager

- 1 “ [スタート (Start)]” ▶ “すべてのプログラム (All programs)”
 - ▶ “NTT DOCOMO”
 - ▶ “ドコモ コネクションマネージャ (DOCOMO Connection Manager)”
 - ▶ “ドコモ コネクションマネージャ (DOCOMO Connection Manager)”

“DOCOMO Connection Manager” starts.

2 When this is the first start-up, the setting wizard appears automatically.

Hereafter, proceed operation/settings following the instruction of software to complete the preparation to access the Internet. For details, refer to “ドコモ コネクションマネージャ操作マニュアル (DOCOMO Connection Manager operation manual)”.



■When you disconnect the communication line

You cannot disconnect the communication line only by exiting a browser software or e-mail software.

When you do not use the communication line, be sure to click “切断する (Disconnect)” to disconnect the communication line.

When you have set the auto-update for OS and others, note that you may be charged a high packet communication fee for when they are automatically updated.

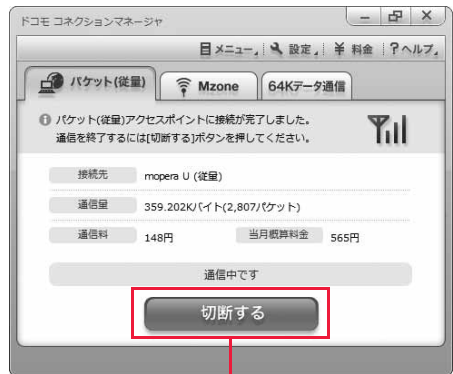

Connect/Disconnect button

Setting Dial-up Network

Set Packet Communication

This section explains how to set up a connection for packet communication without using “DOCOMO Connection Manager”.

The packet communication uses AT commands to carry out the settings from a personal computer. To specify settings, communication software to enter AT command is required. “Hyper Terminal”, which is attached to Windows as the standard software, is used here for explanation.

When using DOCOMO Internet access service “mopera U” or “mopera”, you do not need to set an access point name (APN) (see page 22).

You can set “caller ID notified/not notified” (see page 25) as required. (You need to set “caller ID notified” when using “mopera U” or “mopera”.)

•Windows 7 and Windows Vista do not support “Hyper Terminal”. For these operating systems, use a software program which supports Windows 7 or Windows Vista for setting up the connection. (Follow the settings of the software program used.)

<Packet communication setting flow using AT commands>

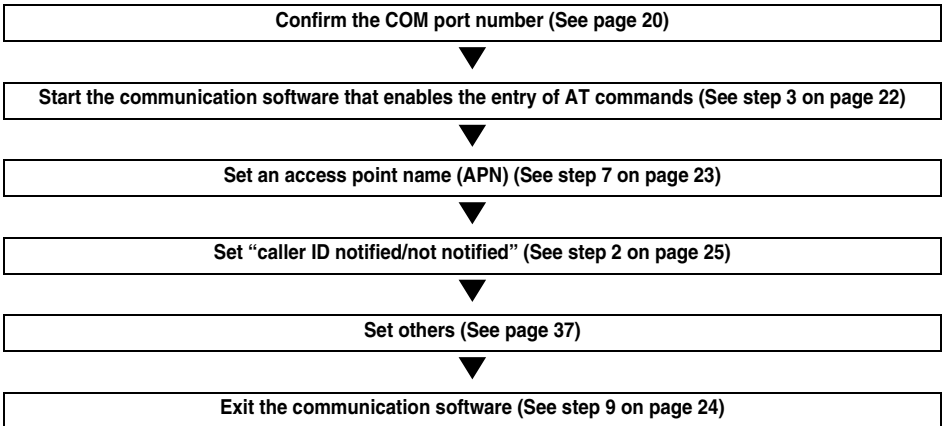

■AT commands

- The AT commands are used to control a modem. The FOMA terminal, which conforms to the AT commands, supports some extended commands and unique AT commands.
- By entering AT commands, you can carry out detailed setting for packet communication and FOMA terminal, and confirm (display) the setting contents.
- If the entered AT command is not displayed, enter “ATE1 ”.

Confirm COM Port Number

To manually carry out the communication setting, you need to specify a COM port number, which is assigned to “FOMA P05C” (modem) embedded after you install the “FOMA communication configuration file” (driver). The confirmation method varies depending on the operating system of your personal computer.

- When using DOCOMO Internet access service “mopera U” or “mopera”, you do not need to set an access point name (APN); therefore, you do not need to confirm the modem.

For Windows 7

1 “ [スタート (Start)]” ▶ Open “コントロールパネル (Control panel)”.

- The “表示方法 (Display method)” changes to “大きいアイコン (Large icon)” or “小さいアイコン (Small icon)” for “カテゴリ (Category)”.

2 Open “電話とモデム (Phone and modem)”.

3 If the “所在地情報 (Address information)” display appears, enter “市外局番/エリアコード (City code/Area code)”, then click “OK”.

4 Open the “モデム (Modem)” tab, confirm the COM port number in the “接続先 (Access point)” field of “FOMA P05C”, then click “OK”.

- When connecting wirelessly using Bluetooth communication, confirm the COM port number of the in-use Bluetooth linked standard modem or Bluetooth modem provided by a Bluetooth device maker in the “接続先 (Access point)” field.
- The COM port number you confirmed is used to set an access point name (APN) (see page 22).
- The contents on the property display and COM port number vary depending on your personal computer.



For Windows Vista

1 “ [スタート (Start)]” ▶ Open “コントロールパネル (Control panel)”.

2 From “ハードウェアとサウンド (Hardware and sound)” in “コントロールパネル (Control panel)”, open “電話とモデムのオプション (Phone and modem options)”.

3 If the “所在地情報 (Address information)” display appears, enter “市外局番/エリアコード (City code/Area code)”, then click “OK”.

4 Open the “モデム (Modem)” tab, confirm the COM port number in the “接続先 (Access point)” field of “FOMA P05C”, then click “OK”.

- When connecting wirelessly using Bluetooth communication, confirm the COM port number of the in-use Bluetooth linked standard modem or Bluetooth modem provided by a Bluetooth device maker in the “接続先 (Access point)” field.
- The COM port number you confirmed is used to set an access point name (APN) (see page 22).
- The contents on the property display and COM port number vary depending on your personal computer.



For Windows XP

1 “スタート (Start)” ▶ Open “コントロールパネル (Control panel)”.

2 From “プリンタとその他のハードウェア (Printer and the other hardware)” in “コントロールパネル (Control panel)”, open “電話とモデムのオプション (Phone and modem options)”.

3 If the “所在地情報 (Address information)” display appears, enter “市外局番/エリアコード (City code/Area code)”, then click “OK”.

4 Open the “モデム (Modem)” tab, confirm the COM port number in the “接続先 (Access point)” field of “FOMA P05C”, then click “OK”.

- When connecting wirelessly using Bluetooth communication, confirm the COM port number of the in-use Bluetooth linked standard modem or Bluetooth modem provided by a Bluetooth device maker in the “接続先 (Access point)” field.
- The COM port number you confirmed is used to set an access point name (APN) (see page 22).
- The contents on the property display and COM port number vary depending on your personal computer.



Set an Access Point Name (APN)

This section explains how to set an access point name (APN) for packet communication. You can register up to 10 access point names (APNs), which are managed with cid1 to cid10 (see page 24).

When using “mopera U” or “mopera”, you do not need to set the access point name (APN).

The explained here is an example when you use “XXX.abc” as the access point name (APN) and use the FOMA USB Cable with Charge Function 02 (option). For the actual access point name (APN), contact your Internet service provider or network administrator.

The setting here will be the access point number for dial-up network setting (see page 26).

For Windows XP

- 1 Connect the FOMA USB Cable with Charge Function 02 to the FOMA terminal.
- 2 Turn the power to the FOMA terminal on, then connect the FOMA USB Cable with Charge Function 02 connected to the FOMA terminal to the personal computer.

- 3 Start Hyper Terminal.

“スタート (Start)”→“すべてのプログラム (All programs)”→“アクセサリ (Accessories)”→“通信 (Communications)”→Open “ハイパーターミナル (Hyper Terminal)”.

After starting Hyper Terminal, when the message “『既定のTelnet』プログラムにしますか? (Select the specified Telnet program?)” is displayed, set as desired. Contact the maker of your personal computer and Microsoft Corporation for the setting contents.

- 4 Enter any name in the “名前 (Name)” field, then click “OK”.

Here, “Sample” is entered as an example.



5 Select a connection method.

<When you can select the COM port number of "FOMA P05C">

Select the COM port number with which you install the "FOMA P05C" in the "接続方法 (Connection method)" field, then click "OK".

Then, go to step 6.

- Here, "COM3" is selected as an example. See page 20 for the COM port number of "FOMA P05C" you should actually select in the "接続方法 (Connection method)" field.



<When you cannot select the COM port number of "FOMA P05C">

Click "キャンセル (Cancel)" to close the "接続の設定 (Set a connection)" display, then perform the following operations:

- (1) "ファイル (File)" menu → Select "プロパティ (Properties)".
- (2) Select "FOMA P05C" in the "接続方法 (Connection method)" field of the "接続の設定 (Set a connection)" tab on the "Sampleのプロパティ (Sample properties)" display.
- (3) Uncheck "国/地域番号と市外局番を使う (Use country/region code and city code)".
- (4) Click "OK".

Then, go to step 7.



6 The properties of the COM port number appear on the display, then click "OK".

- This display appears when you select a COM port number in step 5.

7 Set an access point name (APN).

Enter an access point name (APN) in the following format:

AT+CGDCONT = cid, "PDP_type", "APN"

cid: Enter any number from 5 through 10.

※ If you have already specified cid, be careful that its contents are overwritten by the access point name you enter here.

"PDP_type": Enter "PPP" or "IP".

"APN": Enclose an access point name (APN) in double quotation marks ("").

(Example: When specifying APN "XXX.abc" in cid5)

AT+CGDCONT=5,"PPP","XXX.abc"

Enter this character string, then press [Enter]. If "OK" appears, the APN setting is completed.

- To confirm the current APN setting, enter "AT+CGDCONT?" [Enter]. The set APNs are listed on the display.



8 Confirm that “OK” appears on the display.



9 “ファイル (File)” menu ▶ Select “ハイパーターミナルの終了 (Exit Hyper Terminal)” to exit Hyper Terminal.

- If the message “現在、接続されています。切断してもよろしいですか? (Currently connected. Do you want to disconnect this line?)” appears, select “はい (Yes)”.
- The message “セッションXXXを保存しますか? (Do you want to save session XXX?)” then appears. You do not need to especially save that session.

Information

- The access point name (APN) is information to be registered in the FOMA terminal, so if you connect another FOMA terminal, you need to register the access point name (APN) again.
- To continue using the access point name (APN) of the personal computer, register the same access point name (APN) for the same cid number in the FOMA terminal.
- If the entered AT command is not displayed, enter “ATE1 ”.

■cid (Registration number)

The FOMA terminal has registration numbers cid1 through cid10. cid1 contains “mopera.ne.jp”, cid2 and cid3 contain “mopera.net”, and cid4 contains “mpr.ex-pkt.net” as the default access point names (APN). To connect to a provider other than “mopera U” or “mopera”, the access point name (APN) must be set to the number from cid5 to cid10 specified by the provider or network administrator.

Default cid contents

Registration No. (cid)	Access point name (APN)
1	mopera.ne.jp (PPP)
2	mopera.net (PPP)
3	mopera.net (IP)
4	mpr.ex-pkt.net (PPP)
5 to 10	Not set

■“Phone number” for connecting to an access point name (APN) you register in cid

“*99**<cid No.>#”

(Example) When connecting to the access point name (APN) you register in cid5, enter the following:

*99**5#

■Resetting/Confirming the access point name (APN) settings

You can use AT commands to reset/confirm the access point name (APN) settings.

Resetting access point name (APN)

The access point name (APN) for cid1 returns to “mopera.ne.jp” (default), the names for cid2 and cid3 return to “mopera.net” (default), and the name for cid4 returns to “mpr.ex-pkt.net” (default). The settings for cid5 through cid10 will be reset to the unregistered status if you proceed with resetting.

(Entry method)

AT+CGDCONT= (When resetting all the cid contents)

AT+CGDCONT=<cid> (When resetting only a specific cid)

Confirming access point name (APN)

The currently specified access point name appears on the display.

(Entry method)

AT+CGDCONT?

Set Caller ID Notified/Not Notified

For packet communication, you can specify whether to notify your caller ID (caller ID notified/not notified). The caller ID is your important information; so, take a great care to notify your caller ID. You can use AT commands (*DGPIR command) to specify “caller ID notified/not notified” before dial-up connection.

1 Start the communication software such as “Hyper Terminal”.

- See page 22 for details on how to operate “Hyper Terminal”.

2 Use the *DGPIR command (see page 39) to specify “caller ID notified/not notified”.

- To automatically add “184 (not notify)” for outgoing or incoming call, enter the following:
AT*DGPIR=1
- To automatically add “186 (notify)” for outgoing or incoming call, enter the following:
AT*DGPIR=2



3 Confirm that “OK” appears on the display.



Information

- When using DOCOMO Internet access service “mopera U” or “mopera”, you need to set your caller ID to be “notified”.
- If the entered AT command is not displayed, enter “ATE1 ”.

■ Specifying “caller ID notified/not notified” in dial-up network

Also by dial-up network setting (see page 26), you can add “186 (notify)” or “184 (not notify)” to each access point number.

When you specify “186 (notify)” or “184 (not notify)” using both the *DGPIR command and dial-up network setting, the caller ID is set as follows:

Dial-up network setting (cid = 3)	Caller ID notification setting by *DGPIR command	Notify/Not notify caller ID
*99***3#	Not set	Notify
	Not notify	Not notify
	Notify	Notify
184*99***3#	Not set	Not notify
	Not notify	(“184” specified in the dial-up network has a priority)
	Notify	
186*99***3#	Not set	Notify
	Not notify	(“186” specified in the dial-up network has a priority)
	Notify	

- To connect to “mopera U” or “mopera”, you need to notify your caller ID.

Set Dial-up Network for Windows 7

1

- “ [スタート (Start)]”
- ▶ Open “コントロールパネル (Control panel)”
 - ▶ “インターネットへの接続 (Connection to Internet)”
 - ▶ Click “ダイヤルアップ接続 (Dial-up connection)”.

•After the access point has been set, the confirmation display appears asking whether the existing connection is to be used. In response, check “いいえ、新しい接続を作成します (No, I will create a new connection)”, then click “次へ (Next)”.

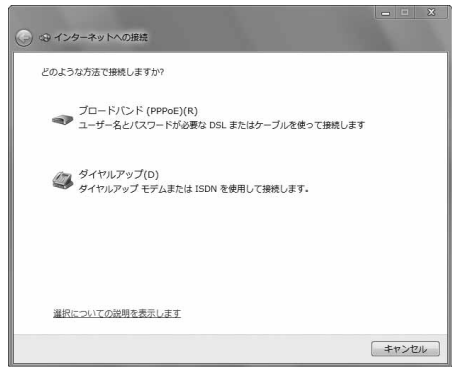

2

If the display for selecting a modem appears, click “FOMA P05C”.

- When connecting wirelessly using Bluetooth communication, put a check mark for only the in-use Bluetooth linked standard modem or Bluetooth modem provided by a Bluetooth device maker.
- The display for selecting a modem appears only when you have registered two or more modems.

3

Enter an access point number in the “ダイヤルアップの電話番号 (Phone number for dial-up)” field.

- When connecting to “mopera U”, enter “*99**:*3#” as the access point number.
See page 24 for access point numbers other than “mopera U”.

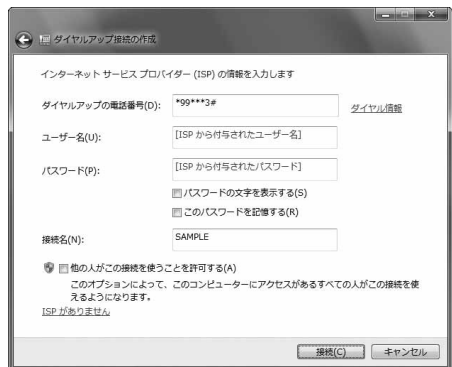

4

Enter the user name and password supplied from your Internet service provider or network administrator in the “ユーザー名 (User name)” and “パスワード (Password)” fields.

- When connecting to “mopera U” or “mopera”, you can leave the user name and password fields blank.

5

Enter any name in the “接続名 (Connection name)” field. Then click “接続 (Connect)” ▶ Click “スキップ (Skip)”.

- Here, “SAMPLE” is entered as an example.
- Only confirm the setting contents without connecting here.

6

Click “閉じる (Close)”.

7

- “ [スタート (Start)]”
- ▶ Open “コントロールパネル (Control panel)”
 - ▶ “ネットワークの状態とタスクの表示 (View network status and tasks)”
 - ▶ Click “アダプターの設定の変更 (Change the adapter settings)”.

8 Highlight the access point which is finished with setting, and select “プロパティ (Property)” after the right click

▶ Click the “全般 (General)” tab to confirm the setting contents.

When two or more modems are connected to your personal computer, confirm that “モデム (Modem) - FOMA P05C (COM5)” or “モデム (Modem) - the name of the in-use Bluetooth linked standard modem or Bluetooth modem provided by a Bluetooth device maker” is checked in the “接続の方法 (Connection method)” field. If it is not checked, check it. If two or more modems are checked, click the  button to position the priority level of “モデム (Modem) - FOMA P05C” or “モデム (Modem) - the name of the in-use Bluetooth linked standard modem or Bluetooth modem provided by a Bluetooth device maker” to the top or uncheck modems other than “モデム (Modem) - FOMA P05C” or “モデム (Modem) - the name of the in-use Bluetooth linked standard modem or Bluetooth modem provided by a Bluetooth device maker”.

When “ダイヤル情報を使う (Use dial information)” is checked, uncheck it.

•The COM port number allocated to “FOMA P05C” or “the in-use Bluetooth linked standard modem or Bluetooth modem provided by a Bluetooth device maker” varies depending on your personal computer.

•When connecting to “mopera U”, enter “*99**3#” as the access point number.

See page 24 for access point numbers other than “mopera U”.



9 Click the “ネットワーク (Network)” tab, then carry out respective settings.

In the “この接続は次の項目を使用します (Use the following items for this connection)” field, select “インターネットプロトコルバージョン4 (TCP/IPv4) [Internet protocol version 4 (TCP/IPv4)]”.

Contact your ISP (Internet service provider) or network administrator for how to set up TCP/IP to connect to a general ISP and so on.

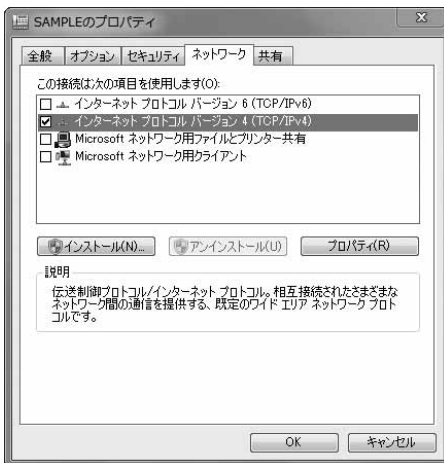

10 Click the “オプション (Option)” tab, then click “PPP設定 (PPP settings)”.

11 Uncheck all the items, then click “OK”.

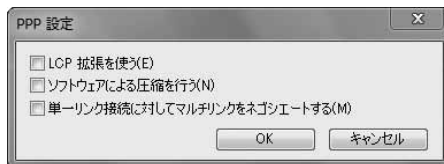

12 Return to the display in step 9, then click “OK”.

Set Dial-up Network for Windows Vista

1 “ [スタート (Start)]” ▶ “**接続先 (Access point)**” ▶ Click “**接続またはネットワークをセットアップします (Setup the connection or network)**”.

2 Select “**ダイヤルアップ接続をセットアップします (Setup the dial-up connection)**”, then click “**次へ (Next)**”.



3 If the display for selecting a modem appears, click “**FOMA P05C**”.

- When connecting wirelessly using Bluetooth communication, put a check mark for only the in-use Bluetooth linked standard modem or Bluetooth modem provided by a Bluetooth device maker.
- The display for selecting a modem appears only when you have registered two or more modems.

4 Enter an access point number in the “**ダイヤルアップの電話番号 (Phone number for dial-up)**” field.

- When connecting to “mopera U”, enter “*99**3#” as the access point number.
See page 24 for access point numbers other than “mopera U”.

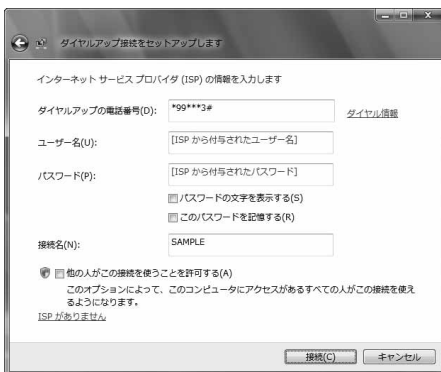

5 Enter the user name and password supplied from your Internet service provider or network administrator in the “**ユーザー名 (User name)**” and “**パスワード (Password)**” fields.

- When connecting to “mopera U” or “mopera”, you can leave the user name and password fields blank.

6 Enter any name in the “**接続名 (Connection name)**” field. Then click “**接続 (Connect)**” ▶ Click “**スキップ (Skip)**”.

- Here, “SAMPLE” is entered as an example.
- Only confirm the setting contents without connecting here.

7 Click “**接続をセットアップします (Setup the connection)**” ▶ Click “**閉じる (Close)**”.

8 “ [スタート (Start)]” ▶ “**接続先 (Access point)**”

▶ Highlight the access point which is finished with connection, and select “**プロパティ (Property)**” after the right click.

9 Click the “全般 (General)” tab to confirm the setting contents.

When two or more modems are connected to your personal computer, confirm that “モデム (Modem) - FOMA P05C” or “モデム (Modem) - the name of the in-use Bluetooth linked standard modem or Bluetooth modem provided by a Bluetooth device maker” is checked in the “接続の方法 (Connection method)” field. If it is not checked, check it. If two or more modems are checked, click the  button to position the priority level of “モデム (Modem) - FOMA P05C” or “モデム (Modem) - the name of the in-use Bluetooth linked standard modem or Bluetooth modem provided by a Bluetooth device maker” to the top or uncheck modems other than “モデム (Modem) - FOMA P05C” or “モデム (Modem) - the name of the in-use Bluetooth linked standard modem or Bluetooth modem provided by a Bluetooth device maker”.

When “ダイヤル情報を使う (Use dial information)” is checked, uncheck it.

- The COM port number allocated to “FOMA P05C” or “the in-use Bluetooth linked standard modem or Bluetooth modem provided by a Bluetooth device maker” varies depending on your personal computer.
- When connecting to “mopera U”, enter “*99***3#” as the access point number.
See page 24 for access point numbers other than “mopera U”.

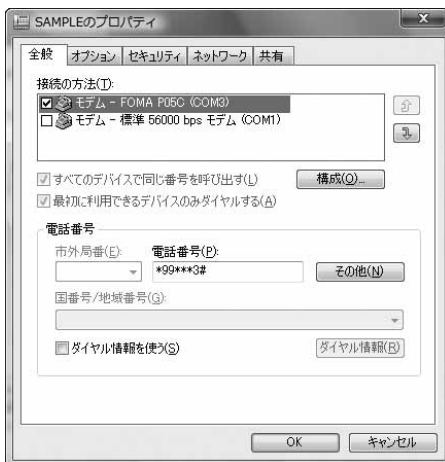

10 Click the “ネットワーク (Network)” tab, then carry out respective settings.

In the “この接続は次の項目を使用します (Use the following items for this connection)” field, select “インターネットプロトコルバージョン4 (TCP/IPv4) [Internet protocol version 4 (TCP/IPv4)]”.

You can set the “QoS パケットスケジューラ (QoS packet scheduler)” if necessary.

Contact your ISP (Internet service provider) or network administrator for how to set up TCP/IP to connect to a general ISP and so on.



11 Click the “オプション (Option)” tab, then click “PPP設定 (PPP settings)”.

12 Uncheck all the items, then click “OK”.

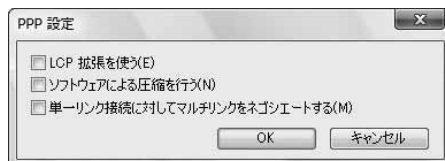

13 Return to the display in step 10, then click “OK”.

Set Dial-up Network for Windows XP

- 1 “スタート (Start)” ▶ “すべてのプログラム (All programs)”
▶ “アクセサリ (Accessories)” ▶ “通信 (Communications)”
▶ Open “新しい接続ウィザード (New connection wizard)”.

- 2 When the “新しい接続ウィザード (New connection wizard)” display appears, click “次へ (Next)”.

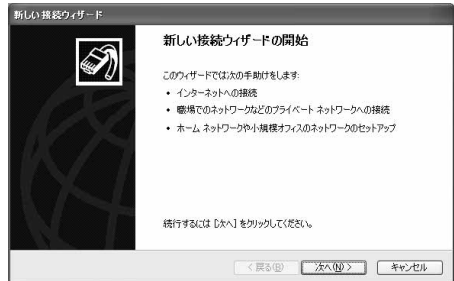

- 3 Select “インターネットに接続する (Connect to the Internet)”, then click “次へ (Next)”.
- 4 Select “接続を手動でセットアップする (Manually set up the connection)”, then click “次へ (Next)”.
- 5 Select “ダイヤルアップモデムを使用して接続する (Use a dial-up modem for connection)”, then click “次へ (Next)”.
- 6 If the “デバイスの選択 (Select a device)” display appears, check “FOMA P05C” only, then click “次へ (Next)”.

- When connecting wirelessly using Bluetooth communication, put a check mark for only the in-use Bluetooth linked standard modem or Bluetooth modem provided by a Bluetooth device maker.
- The “デバイスの選択 (Select a device)” display appears only when you have registered two or more modems.

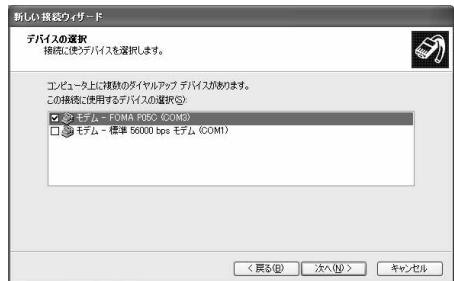

- 7 Enter any name in the “ISP 名 (ISP name)” field, then click “次へ (Next)”.

- Here, “SAMPLE” is entered as an example.



8 Enter an access point number in the “電話番号 (Phone number)” field, then click “次へ (Next)”.

- When connecting to “mopera U”, enter “*99**3#” as the access point number.

See page 24 for access point numbers other than “mopera U”.

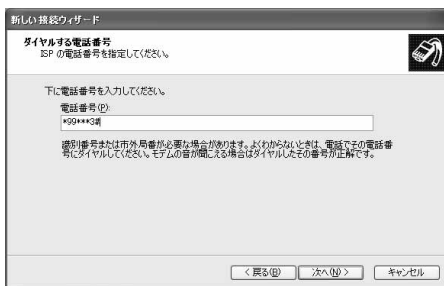

9 Enter the user name and password supplied from your Internet service provider or network administrator in the “ユーザー名 (User name)”, “パスワード (Password)” and “パスワードの確認入力 (Confirm the password)” fields. Then click “次へ (Next)”.

- When connecting to “mopera U” or “mopera”, you can leave the user name and password fields blank.

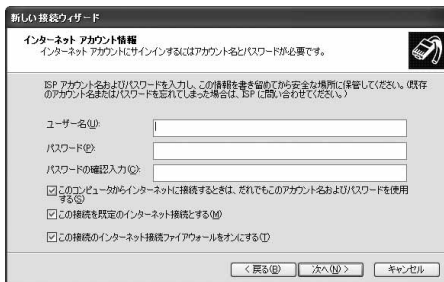

10 Click “完了 (Complete)”.

11 スタート (Start)” ▶ “すべてのプログラム (All programs)” ▶ “アクセサリ (Accessories)” ▶ “通信 (Communications)” ▶ Open “ネットワーク接続 (Connect to network)”.

12 Select the dial-up icon, then select “ネットワークタスク (Network task)”

- ▶ “この接続の設定を変更する (Modify this connection setting)”.

Here, click the icon of the name you entered in step 7.



13 Click the “全般 (General)” tab to confirm the setting contents.

When two or more modems are connected to your personal computer, confirm that “モデム (Modem) - FOMA P05C” or “モデム (Modem) - the name of the in-use Bluetooth linked standard modem or Bluetooth modem provided by a Bluetooth device maker” is checked in the “接続方法 (Connection method)” field. If it is not checked, check it. If two or more modems are checked, click the  button to position the priority level of

“モデム (Modem) - FOMA P05C” or “モデム (Modem) - the name of the in-use Bluetooth linked standard modem or Bluetooth modem provided by a Bluetooth device maker” to the top or uncheck modems other than “モデム (Modem) - FOMA P05C” or “モデム (Modem) - the name of the in-use Bluetooth linked standard modem or Bluetooth modem provided by a Bluetooth device maker”.

When “ダイヤル情報を使う (Use dial information)” is checked, uncheck it.

- The COM port number allocated to “FOMA P05C” or “the in-use Bluetooth linked standard modem or Bluetooth modem provided by a Bluetooth device maker” varies depending on your personal computer.
- When connecting to “mopera U”, enter “*99**3#” as the access point number.

See page 24 for access point numbers other than “mopera U”.



14 Click the “ネットワーク (Network)” tab, then carry out respective settings.

In the “呼び出すダイヤルアップサーバーの種類 (Type of calling dial-up server)” field, select “PPP: Windows 95/98/NT4/2000, Internet”.

In the “この接続は次の項目を使用します (Use the following items for this connection)” field, select “インターネットプロトコル (TCP/IP) [Internet protocol (TCP/IP)]”.

You cannot modify the setting of the “QoS パケットスケジューラ (QoS packet scheduler)” field; so use the default setting as it is. Next, click “設定 (Setting)”.

Contact your ISP (Internet service provider) or network administrator for how to set up TCP/IP to connect to a general ISP and so on.



15 Uncheck all the items, then click “OK”.

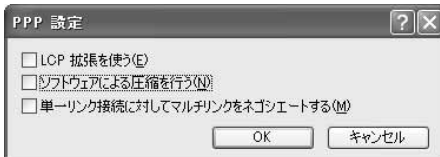

16 Return to the display in step 14, then click “OK”.

Making Dial-up Connection

Making Dial-up Connection for Windows 7

Perform the operation on page 5 to connect the FOMA terminal to your personal computer.

1 “ [スタート (Start)]”▶ Open “コントロールパネル (Control panel)”
▶ Click “インターネットへの接続 (Connection to Internet)”.

2 Check “はい、既存の接続を選びます (Yes, I choose the existing connection)”, then select the access point, and click “次へ (Next)”.



3 Confirm the contents and click “ダイヤル (Dial)”.

•When connecting to “mopera U” or “mopera”, you can leave the user name and password fields blank.

4 The display appears to indicate the connecting state.

In this period, the system performs logon processing to confirm the user name and password.



5 After the connection is completed, click “閉じる (Close)”.

•You can start the browser software to browse websites, use e-mail and so on.

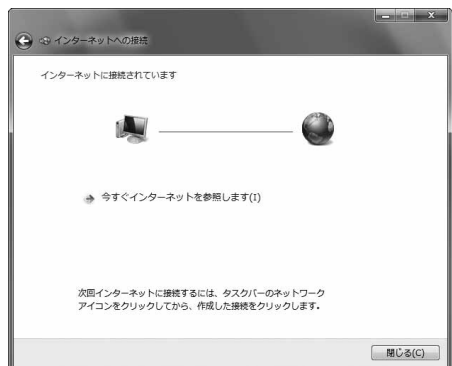

Making Dial-up Connection for Windows Vista

Perform the operation on page 5 to connect the FOMA terminal to your personal computer.

1 “ [スタート (Start)]” ▶ Open “接続先 (Access point)”.

2 Select access point and click “接続 (Connect)”.



3 Confirm the contents and click “ダイヤル (Dial)”.

•When connecting to “mopera U” or “mopera”, you can leave the user name and password fields blank.

4 The display appears to indicate the connecting state.

In this period, the system performs logon processing to confirm the user name and password.



5 After the connection is completed, click “閉じる (Close)”.

•You can start the browser software to browse websites, use e-mail and so on.

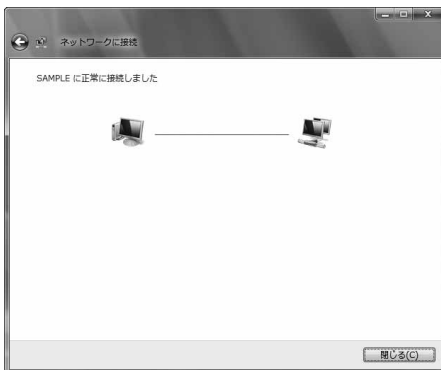

Making Dial-up Connection for Windows XP

Perform the operation on page 5 to connect the FOMA terminal to your personal computer.

- 1 “スタート (Start)” ▶ “すべてのプログラム (All programs)”
▶ “アクセサリ (Accessories)” ▶ “通信 (Communications)”
▶ Open “ネットワーク接続 (Network connection)”.

- 2 Open the access point to be used.

Select the access point icon of the ISP name (see page 30) you specified in “Set Dial-up Network”, then “ネットワークタスク (Network task)”→“この接続を開始する (Start this connection)”.

Otherwise, double-click the access point icon.



- 3 Confirm the contents and click “ダイヤル (Dial)”.

•When connecting to “mopera U” or “mopera”, you can leave the user name and password fields blank.

- 4 The display appears to indicate the connecting state.

In this period, the system performs logon processing to confirm the user name and password.



- 5 The connection is completed.

After the connection is completed, the message appears from the indicator on the task bar for a few seconds.

- You can start the browser software to browse websites, use e-mail and so on.
- If this message does not appear, confirm the setting of the access point again.



Information

- For dial-up connection, use the FOMA terminal with the dial-up setting completed. To connect another FOMA terminal, you may need to reinstall the FOMA communication configuration file (driver).
- The power consumption of the FOMA terminal increases during communication.
- During packet communication, the communication state appears on the FOMA terminal.

“ ” (Communicating, data sending)	“ ” (Communicating, data receiving)
“ ” (Communicating, no data sending/receiving)	“ ” (Outgoing or being disconnected)
“ ” (Incoming or being disconnected)	
- During 64K data communication, “ ” appears on the FOMA terminal.

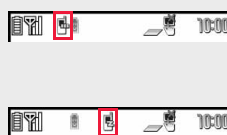

Disconnecting Communication Line

- 1 Click the dial-up icon on the task tray.

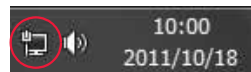

- 2 Select the access point with which the connection is to be terminated, and click “切断 (Disconnect)”.

<For Windows Vista>

Select “接続または切断 (Connect or disconnect)” and click “切断 (Disconnect)”, then click “閉じる (Close)”.

<For Windows XP>

Click “切断 (Disconnect)”.

Information

- The communication line may not be disconnected just by exiting the browser software. To surely disconnect the communication line, perform this operation.
- The baud rate displayed on your personal computer may be different from the actual one.

When you cannot connect to network

If you cannot connect to network (if you fail a dial-up connection), confirm the following items:

If this error occurs	Confirm those:
Your personal computer cannot recognize "P-05C"	<ul style="list-style-type: none">· Confirm whether your personal computer satisfies the operating environment (see page 3).· Confirm whether "FOMA communication configuration file" (driver) is installed in your personal computer.· Confirm whether the FOMA terminal is connected to your personal computer and powered on.· Confirm whether the FOMA USB Cable with Charge Function 02 (option) is securely connected.· Confirm whether the Bluetooth device is connected using the Dial-up service.
You cannot connect to the access point	<ul style="list-style-type: none">· Confirm whether the ID (user name) and password are correct.· When you need to notify your caller ID such as when using "mopera U" or "mopera", make sure "184" is not prefixed to the phone number.· Confirm that "フロー制御を使う (Use the flow control)" is checked in the modem properties.· If you cannot connect to the access point even after confirming above, contact your Internet service provider or network administrator for the setting method, and so on.

Set 64K Data Communication

This section explains how to set up a connection for the 64K data communication without using "DOCOMO Connection Manager".

Setting dial-up connection and TCP/IP

The setting of dial-up connection and TCP/IP for the 64K data communication is the same as for the packet communication (see page 19).

Take care of the following points:

- In the 64K data communication, you do not need to set an access point name (APN). For the access point of the dial-up connection, enter the phone number of the access point specified by your Internet service provider or network administrator. (To connect to "mopera U", enter "*8701" in the phone number field, and to connect to "mopera", enter "*9601".)
- Set "caller ID notified/not notified" and "others" as required.
(When connecting to "mopera U" or "mopera", you need to notify your caller ID.)
- Contact your Internet service provider or network administrator for details on the setting contents.

Connecting and Disconnecting

You can operate in the same way as for the packet communication. Perform the operations on page 18, page 33 or page 35.

AT Command

AT commands are used to specify and modify the functions of the FOMA terminal through the personal computer.

※The following abbreviations are used in the AT command list:

[AT]: Commands which are available at the FOMA P05C Command Port.

[M]: Commands which are available in the FOMA P05C (modem).

[&F]: Commands whose settings are initialized by the AT&F command.

[&W]: Commands whose settings are saved by the AT&W command. The set value can be recalled by the ATZ command.

Information

- When you make a call from an external device or make an AT command call, the call is made from Number A in A Mode or Dual Mode of 2in1, and the call is made from Number B in B Mode of 2in1.

Entry Format of AT Command

To enter an AT command, use the terminal mode display of the communication software. Be sure to enter half-pitch alphanumeric characters.

- Entry example

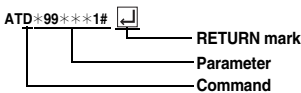

- You need to enter an AT command on one line, including a parameter (digits and symbols) which follows the command.

Information

- The terminal mode enables you to operate a personal computer as one communication terminal. Using this mode, you can send characters you have entered from the keyboard to a line connected to the communication port.

Switch between Online Data Mode and Online Command Mode

There are following two methods of switching the FOMA terminal between the online data mode and online command mode:

· Enter the “+++” command or enter the code specified in the “S2” register.

· Set the ER signal of the RS-232C※ off when “AT&D1” is set.

•To switch the online command mode to the online data mode, enter “ATO”.

※The RS-232C signal line, which is emulated via the USB interface, is controlled by a communication application.

■Saving the setting contents

Please be careful that the setting contents with AT commands are initialized when the FOMA terminal is turned off and on or the external device is removed, except for the access point name (APN) setting with the AT+CGDCONT command, QoS setting with the AT+CGEQMIN or AT+CGEQREQ command, incoming call acceptance/rejection setting with the AT*DGAPL, AT*DGARL, or AT*DGANSM command, phone number notification/no notification setting (for packet communication) with the AT*DGPIR command and caller ID notification restriction setting with the AT+CLIR command. For commands with [&W], you can enter “AT&W” (after setting) to save the setting contents and other set values with [&W] at the same time. If necessary, you can restore these set values by entering in “ATZ” even after the power is turned off and on.

AT Command List

AT command	Outline	Parameter/Explanation	Command execution example
A/ [M]	Re-executes the last executed command. No carriage return is required.	—	A/ OK
AT%V [M]	Displays the version of the FOMA terminal.	—	AT%V Ver1.00 OK
AT&Cn [M] [&F]&[W]	Selects the operating conditions of the circuit CD signal sent to the DTE.	n=0: CD is always ON. n=1: CD varies according to the carrier of the other party's modem. (default)	AT&C1 OK
AT&Dn [M] [&F]&[W]	Selects an operation to be performed when the circuit ER signal received from the DTE transits from ON to OFF.	n=0: Ignores the ER status. (Always assumed to be ON.) n=1: Sets the online command state when the ER changes from ON to OFF. n=2: Sets the offline command state when the ER changes from ON to OFF. (default)	AT&D1 OK
AT&En [M] [&F]&[W]	Selects the speed display specification for connection.	n=0: Displays communication speed between radio wave blocks. n=1: Displays DTE serial communication speed. (default)	AT&E0 OK
AT&Fn [AT][M]	Returns all registers to the default. Performs line disconnection processing if you enter this command during communication.	Only n=0 is specifiable. (Can be omitted)	—
AT&Sn [M] [&F]&[W]	Specifies the control of the data set ready signal to be output to the DTE.	n=0: DR is always ON. (default) n=1: DR is set to ON at connection of the line (at establishment of a communication call).	AT&S0 OK
AT&Wn [M]	Stores the current set values.	Only n=0 is specifiable. (Can be omitted)	—
AT* DANTE [AT][M]	Shows the number of antenna bars. (0 to 3)	0: Antenna shows the out of the service area 1: Zero antenna bars or a single antenna bar 2: Two antenna bars 3: Three antenna bars	AT* DANTE * DANTE:3 OK AT* DANTE=? * DANTE:(0-3) OK
AT* DGANSM=n [M]	Sets the reject/accept setting mode for the packet incoming call. The setting with this command is valid for incoming calls in packet communication after you enter the setting command.	n=0: Invalidates the incoming call reject/accept setting. (default) n=1: Validates the incoming call reject setting (AT* DGARL). n=2: Validates the incoming call accept setting (AT* DGAPL). AT* DGANSM?: Displays the current setting.	AT* DGANSM=0 OK AT* DGANSM? * DGANSM:0 OK
AT* DGAPL=n [,cid] [M]	Sets the APN of which packet incoming call is to be accepted. To specify the APN, use the <cid> parameter defined in AT+CGDCONT.	n=0: Adds the APN defined by <cid> to the incoming call accept list. n=1: Deletes the APN defined by <cid> from the incoming call accept list. Applied to all the cid contents if <cid> is omitted. AT* DGAPL?: Displays the incoming call accept list.	AT* DGAPL=0,1 OK AT* DGAPL? * DGAPL:1 OK AT* DGAPL=1 OK AT* DGAPL? OK
AT* DGARL=n [,cid] [M]	Sets the APN of which packet incoming call is to be rejected. To specify the APN, use the <cid> parameter defined in +CGDCONT.	n=0: Adds the APN defined by <cid> to the incoming call reject list. n=1: Deletes the APN defined by <cid> from the incoming call reject list. Applied to all the cid contents if <cid> is omitted. AT* DGARL?: Displays the incoming call reject list.	AT* DGARL=0,1 OK AT* DGARL? * DGARL:1 OK AT* DGARL=1 OK AT* DGARL? OK

AT command	Outline	Parameter/Explanation	Command execution example
AT+DGPIR=n [M]	This command is valid at dialing/receiving calls. In the dial-up network setting, you can add "186" (notify) or "184" (not notify) to the phone number of the access point. (See page 25)	n=0: Uses the APN as it is. (default) n=1: Adds "184" to the APN. (always not notify) n=2: Adds "186" to the APN. (always notify) AT+DGPIR?: Displays the current setting.	AT+DGPIR=0 OK AT+DGPIR? +DGPIR:0 OK
AT+DRPW [AT][M]	Displays the output power index for receiving. (0: minimum value to 75: maximum value)	—	AT+DRPW +DRPW:0 OK
+++ [M]	Changes to the online command state without disconnecting the line when the escape sequence is executed in the online mode.	—	—
AT+CAOC [M]	Displays the charging information for now or latest call.	Result: +CAOC:"n" n: Displays the charging information in a hexadecimal number.	AT+CAOC +CAOC:"00001E" OK
AT+CBC [M]	Displays the battery level.	Result: +CBC:n,m n=0: FOMA terminal is powered by the battery. n=1: During charging n=2: The battery is not connected. n=3: Power-supply error m=0~100: Battery level	AT+CBC +CBC:0,80 OK
AT+CBST=n,1,0 [M] [&W][&F]	Sets the bearer service to be used.	n=116: 64000 bps (bit transparent) (default) n=134: 64000 bps (multimedia)	AT+CBST=116,1,0 OK AT+CBST? +CBST:116,1,0 OK
AT+CDIP=n [M][AT] [&F][&W]	Sets whether to display "Received sub-address" on your personal computer when you receive a call.	n=0: Does not display "Received sub-address" when you receive a call. (default) n=1: Displays "Received sub-address" when you receive a call. Result: +CDIP:<n>,<m> m=0: Not signed up for Multi Number m=1: Signed up for Multi Number m=2: Unknown	AT+CDIP=0 OK AT+CDIP? +CDIP:0,1 OK
AT+CEER [AT][M]	Displays the reason why the preceding call was disconnected.	<report> Disconnection reason list (See page 46)	AT+CEER +CEER:36 OK
AT+CGDCONT [M]	Sets the access point name (APN) for when dialing for packet communication.	See page 44.	See page 44.
AT+CGEQMIN [M]	Registers the reference value to judge whether the system permits QoS (Quality of service) reported from the network at establishment of the packet communication.	AT+CGEQMIN=[parameter] See page 45. AT+CGEQMIN=? Lists the settable values. AT+CGEQMIN? Displays the current setting.	See page 45.
AT+CGEQREQ [M]	Sets QoS (Quality of service) to be requested to the network at dialing of the packet communication.	AT+CGEQREQ=[parameter] See page 45. AT+CGEQREQ=? Lists the settable values. AT+CGEQREQ? Displays the current setting.	See page 45.
AT+CGMR [M]	Displays the version of the FOMA terminal.	—	AT+CGMR 1234512345123456 OK

AT command	Outline	Parameter/Explanation	Command execution example
AT+CGREG=n [M] [&F]&W	Sets whether the network registration state is notified. Displays whether you are inside or outside the service area according to the returned notification.	n=0: Not notified. (default) n=1: Notified at switching between the inside and outside of the service area. (Inquiry) AT+CGREG? +CGREG: <n>,<stat> n: Set value stat: 0: Outside packet area 1: Inside packet area 4: Unknown 5: Inside packet area (during roaming)	AT+CGREG=1 OK (set to "Notified") AT+CGREG? +CGREG:1,0 OK (means the outside of the service area) (when moved from the outside to the inside of the service area) +CGREG: 1
AT+CGSN [M]	Displays the serial number of the FOMA terminal.	—	AT+CGSN 123456789012345 OK
AT+CLIP=n [AT][M] [&F]&W	Enables to display the other party's caller ID on the personal computer at reception of 64K data communication or videophone calls.	n=0: Does not notify. (default) n=1: Notifies. Result: +CLIP: <n>,<m> m=0: NW setting not to notify caller ID at calling m=1: NW setting to notify caller ID at calling m=2: Unknown	AT+CLIP=0 OK AT+CLIP? +CLIP:0,1 OK
AT+CLIR=n [M]	Sets whether to notify your phone number to do 64K data communication or to make videophone calls.	n=0: Notifies (does not notify) caller ID according to CLIR service. n=1: Does not notify the other party of your caller ID. n=2: Notifies the other party of your caller ID. (default) Result: +CLIR: <n>,<m> m=0: CLIR is not launched. (always notify) m=1: CLIR is launched. (always not notify) m=2: Unknown m=3: CLIR temporary mode (not notify, default) m=4: CLIR temporary mode (notify, default)	AT+CLIR=0 OK AT+CLIR? +CLIR:0,1 OK AT+CLIR=? +CLIR:(0-2) OK
AT+CMEE=n [M] [&F]&W	Sets how the FOMA terminal shows an error report.	n=0: Uses the ordinary ERROR result. (default) n=1: +CME ERROR: Uses the <err> result code. <err> indicates a numeric value. n=2: +CME ERROR: Uses the <err> result code. <err> indicates characters. AT+CMEE?: Displays the current setting. Command execution examples on the right are for when the FOMA terminal or connection has abnormality. Below listed are the +CME ERROR result codes. 1: no connection to phone 10: SIM not inserted 15: SIM wrong 16: incorrect password 100: unknown	AT+CMEE=0 OK AT+CNUM ERROR AT+CMEE=1 OK AT+CNUM +CME ERROR: 10 AT+CMEE=2 OK AT+CNUM +CME ERROR: SIM not inserted
AT+CNUM [AT][M]	Displays the own phone number of the FOMA terminal.	number: Phone number (In B Mode of 2in1, Number B is displayed.) type: 129 or 145 129: Does not include the IDD prefix code (+). 145: Includes the IDD prefix code (+). Result: +CNUM:,<number>,<type>	AT+CNUM +CNUM:,"+8190123 45678",145 OK

AT command	Outline	Parameter/Explanation	Command execution example
AT+COPS=n,2,m [M]	Selects the carrier to be connected.	n=0: Automatic (searches the network and switches the network operator automatically) (default) n=1: Manual (connects to the network operator specified in "m") n=2: Disconnects the connection to the network operator n=3: Mapping is not performed. n=4: Manual/Automatic (if the connection to the network operator specified in "m" fails, works as automatic mode.) m: Country code (MCC) and operator code (MNC) are displayed in a hexadecimal number. The format is as follows: Digit 1 of MCC octet 1 bits 1 to 4. Digit 2 of MCC octet 1 bits 5 to 8. Digit 3 of MCC octet 2 bits 1 to 4. Digit 3 of MNC octet 2 bits 5 to 8. Digit 2 of MNC octet 3 bits 5 to 8. Digit 1 of MNC octet 3 bits 1 to 4.	AT+COPS=1,2,"44F001" OK
AT+CPAS [M]	Displays whether to send the control signals to the FOMA terminal.	Result: +CPAS:n n=0: Can send/receive control signals to/from the FOMA terminal. n=1: Cannot send/receive control signals to/from the FOMA terminal. n=2: Unknown (control signal sending/receiving is not assured), n=3: Can send/receive control signals to/from the FOMA terminal, and currently receiving. n=4: Can send/receive control signals to/from the FOMA terminal, and currently communicating.	AT+CPAS +CPAS:0 OK
AT+CPIN=n,m [M][AT]	Enters the UIM password (PIN1 or PIN2).	When the UIM is in a state waiting for the entry of PIN1 or PIN2 code n: PIN1/PIN2 When the UIM is in a state waiting for the entry of PUK due to failure in unblocking PIN1 or PIN2 code n: PUK m: New PIN1 or PIN2 AT+CPIN?: Displays the state of code entry requested about current SIM. Result: +CPIN: <state> <state>=READY: Code entry not requested <state>=SIM PIN: PIN1 code entry waited <state>=SIM PIN2: PIN2 code entry waited <state>=SIM PUK: PUK entry waited due to failure in unblocking PIN1 code <state>=SIM PUK2: PUK entry waited due to failure in unblocking PIN2 code	AT+CPIN="1234" OK AT+CPIN="12345678","1234" OK AT+CPIN? +CPIN:SIM PIN OK
AT+CR=n [M] [&F][&W]	Displays the bearer service type before the CONNECT result code appears at connection of the line.	n=0: Does not display. (default) n=1: Displays. <serv>: Displays only "GPRS" that means packet communication. (Displays "SYNC" or "AV64K", depending on the line type.) AT+CR?: Displays the current set value.	AT+CR=1 OK ATD*99**1# +CR: GPRS CONNECT
AT+CRC=n [AT][M] [&F][&W]	Sets whether the extended result code is used at reception.	n=0: Does not use +CRING. (default) n=1: Uses +CRING.<type>. AT+CRC?: Displays the current setting. The +CRING format is as follows: +CRING: <type> During PPP packet ringing +CRING: GPRS "PPP",,<APN>	AT+CRC=0 OK AT+CRC? +CRC: 0 OK

AT command	Outline	Parameter/Explanation	Command execution example
AT+CREG=n [AT][M] [&F][&W]	Sets whether the result is displayed about the inside and outside of the service area.	n=0: Not notified. (default) n=1: Notified at switching between the inside and outside of the service area. (Inquiry) AT+CREG? +CREG: <n>,<stat> n: Set value stat: 0: Outside voice call area 1: Inside voice call area 4: Unknown 5: Inside voice call area (during roaming)	AT+CREG=1 OK (set to "Notified") AT+CREG? +CREG: 1,0 OK (means the outside of the service area) (when moved from the outside to the inside of the service area) +CREG: 1
AT+CUSD=n,"<str>",0 [M] [&F][&W]	Sets or checks the additional service for network.	n=0: Does not display mid result. (default) n=1: Displays mid result. <str>: Service code Mid result: m,"<str>",0 m=0: Shows the setting is completed. m=1: Shows the network requires the information.	AT+CUSD=0, OK AT+CUSD=1,"*148*1*0000#",0 +CUSD:0,*148*7#,0 OK
AT+FCLASS=n [M] [&F][&W]	Sets communication class in the FOMA terminal.	n=0: Data communication (default)	AT+FCLASS=0 OK
AT+GCAP [M]	Displays the AT command supported by FOMA terminal.	Result +GCAP: n n=+CGSM: Some or all GSM commands are supported. n=+FCLASS: +FCLASS command is supported. n=+W: +W command is supported.	AT+GCAP +GCAP:+CGSM,+FCLASS,+W OK
AT+GMI [M]	Displays the manufacturer name (Panasonic).	—	AT+GMI Panasonic OK
AT+GMM [M]	Displays the product name (FOMA P-05C) of the FOMA terminal.	—	AT+GMM FOMA P05C OK
AT+GMR [M]	Displays the version of the FOMA terminal.	—	AT+GMR Ver1.00 OK
AT+IFC=n,m [M] [&F][&W]	Selects the flow control method.	n: DCE by DTE m: DTE by DCE 0: No flow control 1: XON/XOFF flow control 2: RS/CS (RTS/CTS) flow control Default: n, m = 2,2 AT+IFC?: Inquires the set value.	AT+IFC=2,2 OK
AT+WS46=n [M]	Selects the wireless communication network of the FOMA terminal.	Returns "ERROR" for the mode setting because the wireless communication network is not selected on the FOMA terminal by this command. n=12: GSM/GPRS n=22: W-CDMA (Wideband CDMA) n=25: Automatic	AT+WS46=22 ERROR AT+WS46? 25 OK
ATA [AT][M]	Performs the receiving process in the mode when the FOMA terminal received the incoming call.	—	RING ATA CONNECT
ATD [AT][M]	Performs the automatic outgoing process to the FOMA terminal according to the contents specified in the parameter and dial parameter.	<cid>: 1 to 10. Displays the APN defined by +CGDCONT. When calling cid1, you can omit the phone number like "ATD:*99*.*#."	ATD:*99*.*#1# CONNECT
ATEn [AT][M] [&F][&W]	Sets whether echo-back is issued to the DTE in the command mode.	n=0: Issues no echo-back. n=1: Issues echo-back. (default)	ATE1 OK
ATHn [AT][M]	Places the FOMA terminal into the on-hook state.	n=0: Disconnects the line. (can be omitted)	(During packet communication) +++ ATH NO CARRIER

AT command	Outline	Parameter/Explanation	Command execution example
ATIn [AT][M]	Displays the ID code.	n=0: Displays "NTT DoCoMo". n=1: Displays the product name. (same as +GMM) n=2: Displays the version of the FOMA terminal. (same as +GMR) n=3: Displays ACMP information element. n=4: Displays the details of the function available for communication on the FOMA terminal.	ATI0 NTT DoCoMo OK ATI1 FOMA P05C OK
ATOn [M]	Returns from the online command mode to the online data mode during communication.	n=0: Returns from the online command mode to the online data mode. (can be omitted)	ATO CONNECT
ATQn [M] [&F]&W]	Sets whether the result code is to be displayed for the DTE.	n=0: Displays the result code. (default) n=1: Does not display the result code.	ATQ0 OK ATQ1 ("OK" is not returned at this time.)
ATS0=n [M] [&F]&W]	Sets the number of rings required until the FOMA terminal automatically receives an incoming call.	n=0: Does not automatically receive an incoming call. (default) n=1 to 255: Automatically receives an incoming call with the specified number of rings. (when $n \geq 10$, does not automatically receive a packet (PPP) incoming call, then the line is disconnected after about 30 seconds.) ATS0?: Inquires the set value.	ATS0=0 OK ATS0? 000 OK
ATS2=n [M] [&F]	Sets the escape character.	n=43: Default n=127: Makes escape processing invalid. ATS2?: Inquires the set value.	ATS2=43 OK ATS2? 043 OK
ATS3=n [M] [&F]	Sets the carriage return (CR) character.	n=13: Default (n=13 only specifiable) ATS3?: Inquires the set value.	ATS3=13 OK ATS3? 013 OK
ATS4=n [M] [&F]	Sets the line feed (LF) character.	n=10: Default (n=10 only specifiable) ATS4?: Inquires the set value.	ATS4=10 OK ATS4? 010 OK
ATS5=n [M] [&F]	Sets the back space (BS) character.	n=8: Default (n=8 only specifiable) ATS5?: Inquires the set value.	ATS5=8 OK ATS5? 008 OK
ATS30=n [M][&F]	Sets the inactive timer (minute). When no user data is sent or received, the connection is cut after the set time has elapsed. This command is for only 64K data communication. When 0 is set, the inactive timer turns OFF.	n=0 to 255 (default=0) (unit: minute)	ATS30=0 OK
ATS103=n [M][&F]	Selects characters to pause for incoming sub-address.	n=0: *(asterisk) n=1: / (slash) (default) n=2: ¥ or back slash	ATS103=0 OK
ATS104=n [M][&F]	Selects characters to pause for outgoing sub-address.	n=0: # (sharp) n=1: % (percentage) (default) n=2: & (and)	ATS104=0 OK
ATVn [M] [&F]&W]	Sets all the result codes in the numeric or alphabetical notation.	n=0: Returns the result code in a numeric value. n=1: Returns the result code in alphabetical characters. (default)	ATV1 OK
ATXn [M] [&F]&W]	Sets whether to display the speed in the CONNECT display at connection. Detects busy tone and dial tone.	n=0: Dial tone not detected; busy tone not detected; speed not displayed. n=1: Dial tone not detected; busy tone not detected; speed displayed. n=2: Dial tone detected; busy tone not detected; speed displayed. n=3: Dial tone not detected; busy tone detected; speed displayed. n=4: Dial tone detected; busy tone detected; speed displayed. (default)	ATX1 OK

AT command	Outline	Parameter/Explanation	Command execution example
ATZn [M]	Resets the setting to the contents of the nonvolatile memory. If this command is entered during communication, the line is disconnected.	Only n=0 is specifiable. (Can be omitted)	(In online) ATZ NO CARRIER (In offline) ATZ OK
AT+Sn [M]	Displays the contents of the each command and S register currently set.	Only n=0 is specifiable. (Can be omitted)	AT+Sn E1 Q0 V1 X4 &C1 &D2 &S0 &E1 ¶V0 S000=000 S002=043 S003=013 S004=010 S005=008 S006=005 S007=060 S008=003 S010=001 S030=000 S103=000 S104=000 OK
AT+Vn [M] [&F]&W]	Selects the response code specifications at connection.	n=0: Does not use the extended result code. (default) n=1: Uses the extended result code.	AT+Vn OK

※The following commands do not result in an error even if specified; however, they do not function as commands.

- AT (AT only entered.)
- ATP (Pulse setting)
- ATS8 (Setting the pause time by comma dialing)
- ATT (Tone setting)
- ATS6 (Setting the pause time taken for dialing)
- ATS10 (Setting the automatic disconnection delay time)

Supplementary Explanation of AT Commands

- Command name: +CGDCONT=[parameter] [M]
 - Outline

This command sets an access point name (APN) for when dialing for packet communication.
 - Format

+CGDCONT=[<cid>[,<PDP_type>[*],<APN>]]
 - Explanation of parameters

You set an access point name (APN) for when dialing for packet communication. See the example below for command instructions.

<cid>※: 1 to 10
<PDP_type>: PPP or IP
<APN>※: Arbitrary

※The <cid> numbers are used to manage access point name (APN) for packet communication, and they are registered in the FOMA terminal. Although it is possible to register numbers cid1 to cid10 in the FOMA terminal, "mopera.ne.jp" (PPP) was already registered for <cid>=1, "mopera.net" (PPP) for <cid>=2, "mopera.net" (IP) for <cid>=3 and "mpr.ex-pkt.net" (PPP) for <cid>=4 prior to purchase. Use numbers 5 to 10 to register other access point names.

<APN> indicates any character string for each access point name.
 - Operation at omission of parameters

+CGDCONT= : Sets all the <cid> contents to the default.
+CGDCONT=<cid> : Sets the specified <cid> to the default.
+CGDCONT=? : Lists the specifiable values.
+CGDCONT? : Displays the current setting.
 - Command execution example

AT+CGDCONT=5,"PPP","abc"
OK

※The command used to register an APN name, abc (cid=5)
※This command, which is a setting command, is not stored in the nonvolatile memory written by [&W], and is not reset by [&F] and [Z], either.

- **Command name:** +CGEQMIN=[parameter] [M]
 - **Outline**

This command registers the reference value to judge whether the system permits QoS (Quality of service) reported from the network at establishment of the packet communication.

You can specify four setting patterns described in the command execution example below.
 - **Format**

+CGEQMIN=[<cid>[,<Maximum bitrate UL>[,<Maximum bitrate DL>]]]
 - **Explanation of parameters**

<cid>※ : 1 to 10

<Maximum bitrate UL>※ : None (default), 2048

<Maximum bitrate DL>※ : None (default), 7232

※ <cid> is a number used to manage an access point name (APN) for packet communication, which is registered in the FOMA terminal.

<Maximum bitrate UL> and <Maximum bitrate DL> are used to specify the maximum baud rates (kbps) for upload and download between the FOMA terminal and base station. "None" (default) accepts all baud rates, however, you may not be able to establish packet communication if you specify 2048 and 7232 because the baud rate less than these values are not accepted.
 - **Operation at omission of parameters**

+CGEQMIN= : Sets all the <cid> contents to the default.

+CGEQMIN=<cid> : Sets the specified <cid> to the default.
 - **Command execution example**

You can specify only the following four setting patterns:
(The setting in (1) is defined in each cid as the default.)

(1)Command that accepts all the baud rates for both upload and download (cid=5)

```
AT+CGEQMIN=5
OK
```

(2)Command that accepts 2048 kbps for upload and 7232 kbps for download (cid=6)

```
AT+CGEQMIN=6,,2048,7232
OK
```

(3)Command that accepts 2048 kbps for upload and all baud rates for download (cid=7)

```
AT+CGEQMIN=7,,2048
OK
```

(4)Command that accepts all baud rates for upload and 7232 kbps for download (cid=8)

```
AT+CGEQMIN=8,,,7232
OK
```

※ This command, which is a setting command, is not stored in the nonvolatile memory written by [∧W], and is not reset by [∧F] and [Z], either.
- **Command name:** +CGEQREQ=[parameter] [M]
 - **Outline**

This command sets QoS (Quality of service) to be requested to the network at dialing of the packet communication.

You can specify only one setting pattern described in the command execution example below, which is set as the default.
 - **Format**

+CGEQREQ=[<cid>]
 - **Explanation of parameter**

<cid>※: 1 to 10

※ <cid> is a number used to manage an access point name (APN) for packet communication, which is registered in the FOMA terminal.
 - **Operation at omission of parameter**

+CGEQREQ= : Sets all the <cid> contents to the default.

+CGEQREQ=<cid> : Sets the specified <cid> to the default.
 - **Command execution example**

You can specify only the following one pattern:
(This setting is defined in each cid as the default.)

(1)Command that requests a connection at arbitrary speed NW sets (cid=5)

```
AT+CGEQREQ=5
OK
```

※ This command, which is a setting command, is not stored in the nonvolatile memory written by [∧W], and is not reset by [∧F] and [Z], either.
- **Command name:** +CLIP
 - **Outline**

The result for "AT+CLIP=1" is displayed in the following format:

+CLIP: <number> <type>
 - **Command execution example**

```
AT+CLIP=1
OK
RING
+CLIP: "09012345678",49
```

Disconnection Reason List

■ 64K Data Communication

Value	Reason
1	The specified number does not exist.
16	The line was normally disconnected.
17	Cannot communicate because the other party is communicating.
18	Dialed but no response has come in within the specified duration.
19	Cannot communicate because the other party is dialing.
21	The other party rejected to receive the call.
63	The network service and options are not valid.
65	The specified transmission performance is not provided.
88	Dialed to or received the call from the phone with different properties.

■ Packet Communication

Value	Reason
27	No APN was found; or an invalid APN was specified.
30	The line was disconnected from the network.
33	You have not applied for the service option you requested.
36	The line was normally disconnected.

Result Codes

■ Result Code List

Numeric notation	Character notation	Meaning
0	OK	Processing has been executed normally.
1	CONNECT	The line has been connected to the other party.
2	RING	An incoming call has arrived.
3	NO CARRIER	The line has been disconnected.
4	ERROR	The system can receive no command.
6	NO DIALTONE	The system can detect no dial tone.
7	BUSY	The system is detecting the busy tone.
8	NO ANSWER	The connection completed; timeout
100	RESTRICTION	The network is restricted.
101	DELAYED	Within restricted redialing time

■ Extended Result Code List

For &E0

Connection speed between the FOMA terminal and the base station is displayed.

Numeric notation	Character notation	Connection speed
121	CONNECT 32000	32,000bps
122	CONNECT 64000	64,000bps
125	CONNECT 384000	384,000bps
133	CONNECT 3648000	3,648,000bps
135	CONNECT 7232000	7,232,000bps

Numeric notation	Character notation	Connection speed
5	CONNECT 1200	1,200bps
10	CONNECT 2400	2,400bps
11	CONNECT 4800	4,800bps
13	CONNECT 7200	7,200bps
12	CONNECT 9600	9,600bps
15	CONNECT 14400	14,400bps
16	CONNECT 19200	19,200bps
17	CONNECT 38400	38,400bps
18	CONNECT 57600	57,600bps
19	CONNECT 115200	115,200bps
20	CONNECT 230400	230,400bps
21	CONNECT 460800	460,800bps

Information

- Result codes are displayed in the character notation (default) when the ATVn command (see page 43) is set to n=1 and displayed in the numeric notation when it is set to n=0.
- The baud rate is displayed to keep the compatibility with a conventional modem connected via RS-232C. However, the FOMA terminal and personal computer are connected via the FOMA USB Cable with Charge Function 02 (option) or Bluetooth communication; so, the baud rate is different from the actual connection speed.
- "RESTRICTION" (numeric notation: 100) means that the communication network is congested. If this result code appears, wait for a while, then connect the line again.

Communication Protocol Result Code List

Numeric notation	Character notation	Meaning
1	PPPOverUD	Connected by 64K data communication
3	AV64K	Connected by 64K videophone
5	PACKET	Connected by packet communication

Result Code Display Examples

- When ATX0 is set:

CONNECT only appears at completion of the connection, regardless of the contents specified in the AT#V command (see page 44).

Example in character notation: ATD*99***1#
CONNECT

Example in numeric notation: ATD*99***1#
1

- When ATX1 is set*1:

· If ATX1 and AT#V0 are set (default):

A result code appears in the following format at completion of the connection: CONNECT<baud rate between the FOMA terminal and PC>

Example in character notation: ATD*99***1#
CONNECT 460800

Example in numeric notation: ATD*99***1#
1 21

· If ATX1 and AT#V1 are set*1:

A result code appears in the following format at completion of the connection:

CONNECT<baud rate between the FOMA terminal and PC>PACKET<access point name (APN)>/<maximum baud rate for upload (the FOMA terminal → wireless base station)>/<maximum baud rate for download (the FOMA terminal ← wireless base station)>*2

Example in character notation: ATD*99***1#
CONNECT 460800 PACKET
mopera.ne.jp /2048/7232

Example in numeric notation: ATD*99***1#
1215

*1 If you specify ATX1 and AT#V1 at the same time, you may not be able to correctly carry out the dial-up connection.

You are advised to use only AT#V0.

*2 The displayed maximum band rate is the one reported from the wireless base station and does not guarantee the actual communication speed.

Kuten Code List

