

# FOMA<sup>®</sup> P706iμ

ISSUE DATE:

'08.7

NAME:

PHONE NUMBER:

MAIL ADDRESS:

INSTRUCTION MANUAL

<sup>NTT</sup>  
docomo

Easy Search/Contents/Precautions	■
Before Using the Handset	■
Voice/Videophone Calls	■
Phonebook	■
Sound/Screen/Light Settings	■
Security Settings	■
Camera	■
i-mode/i-motion/i-Channel	■
Mail	■
i-appli	■
Osaifu-Keitai/ToruCa	■
1Seg	■
Full Browser/PC Movie	■
Data Display/Edit/Management	■
Music&Video Channel/Music Playback	■
Convenient Functions	■
Character Entry	■
Network Services	■
PC Connection	■
Overseas Use	■
Appendix/External Devices	■
Troubleshooting	■
Index/Quick Manual	■

# DOCOMO W-CDMA system

## Thank you for selecting the “FOMA P706ijp”.

Before or during use of the FOMA P706ijp, make sure that you read this manual and the separate manuals for other optional devices thoroughly so that you can use the FOMA P706ijp correctly.

If you feel any inconvenience in reading the manual, contact the DOCOMO Information Center listed on the back page of this manual.

The FOMA P706ijp is designed to be your close partner. Treat it carefully at all times to ensure long-term performance.

### Before using your FOMA phone

- Because the FOMA phones use radio waves, they cannot be used in places where radio waves do not reach, such as inside tunnels, underground, or in buildings; or the outside where radio waves are weak or out of the FOMA service area. They may not be used in the high-rise buildings even when the antennas are unobstructed. You may also experience interruption of calls even when using without moving while the radio waves are strong enough for the three antennas to appear on the display.
- Use the FOMA phone carefully to avoid disturbing other people when in public, or in crowded or quiet places.
- Since the FOMA phones use radio waves as the medium of telecommunication, calls may be tapped by the third party. However, the W-CDMA system automatically supports tapping prevention, so your conversation will be incomprehensible to the third party.
- The FOMA phones change your voice into digital signals and send them to the other party. In places where the radio waves are weak, the digital signals may not be converted correctly, and in such a case, the voice may sound different from the actual original voice.
- The user hereby agrees that the user shall be solely responsible for the result of the use of SSL. Neither DOCOMO nor the certifiers as listed herein make any representation and warranty as for the security in the use of SSL. In the event that the user shall sustain damage or loss due to the use of SSL, neither DOCOMO nor the certifiers shall be responsible for any such damage or loss.  
Certifiers: VeriSign Japan K.K., Cybertrust, Inc., GlobalSign K.K., RSA Security Inc., and SECOM Trust Systems Co., Ltd.
- This FOMA phone supports FOMA Plus-Area and FOMA High-Speed Area.
- The FOMA terminal can be used only via the FOMA network provided by DOCOMO and in DOCOMO's roaming area.

- It is recommended that you make separate notes of the information (such as Phonebook entries, schedule events, text memos, record messages, voice memos, movie memos) stored in the FOMA phone and keep them in a safe place. Note that we cannot be held responsible for the unlikely event of loss of the stored contents due to a malfunction, repair, change of your model, or other mishandling of the FOMA phone.
- You are advised to save your important data files to the microSD card. If you have a personal computer, you can transfer and save the information such as Phonebook entries, mail messages, schedule events, and others to the personal computer by using DOCOMO keitai datalink.

### For Using This Manual

**This FOMA phone supports Kisekae Tool (page 103). If you use Kisekae Tool to change the design of the Menu display, some menu configurations change according to the usage frequency depending on the type of the menu. Further, some menu numbers that are assigned to the menu items do not apply. In that case, you cannot operate as described in this manual, so you are advised to switch to the basic structure menu (page 104), or reset menu settings (page 104).**

**You can download the latest information about this manual from the following DOCOMO web site:**

- User's Manual (PDF file) Download  
(<http://www.nttdocomo.co.jp/english/support/manual/index.html>)
- ※ The URL and the content of the web site might be modified without notice.

## How to Read/Refer to This Manual

In this manual, illustrations and symbols are used in the explanations so that you can correctly and easily use the FOMA phone.

- The operating procedures and displays in this manual are described with the default settings (see page 425 and page 426) of the "BLUE BLACK" handset mainly. However, the following settings are changed.
  - "Display setting" → "Stand-by display": OFF
  - "Display setting" → "Clock" → "Position": Pattern 2
  - "Color theme setting": Yellow
  - "Menu icon setting": Normal (for operation wordings)
- Displays and illustrations described in this manual are for reference. The actual ones might differ.
- In this manual, "Osai-fu-Keitai compatible i-appli which supports the IC card function" is described as "Osai-fu-Keitai compatible i-appli".
- Note that "FOMA P706ju" is referred to as "FOMA phone" in this manual.
- In the operating procedures of this manual, key operations are described with simplified key icons.
- The functions which use a microSD card are described in this manual; however, you need to obtain a microSD card separately to make these functions available. See page 305 for the microSD card.

## How to Refer to This Manual

By the following search methods, you can find pages where your desired functions and services are described:

### From the Index

Search from the index when you know the names of functions or services.

### From Easy Search

Search from keywords for the functions you frequently use or the functions that are convenient if you can know any.

### From the Tabs on the Cover

Search from the tabs printed on the cover.

See the next page for details.

### From the Contents

▶▶ P.6

Search from the contents that categorize functions.

### From the Main Functions

▶▶ P.8

Search from here to use the main functions.

### From the Function List

▶▶ P.422

Search from the function list.

### From Quick Manual

▶▶ P.486

Quick Manual gives you a clear, brief description about basic functions. You can take it when you go out. Further, Quick Manual "For Overseas Use" is attached, so refer to it when you use the FOMA phone overseas.

It is prohibited to copy all or part of this manual without permission.  
The instructions contained in this manual may be changed without notice.

How to search for “Alarm” is explained here as an example of search method.

## From the Index

▶▶ P.478

Search for a function or a service name as shown on the right.

Alarm		1/2
Alarm clock1	OFF	
Alarm clock2	OFF	
Alarm clock3	OFF	
Alarm clock4	OFF	
Alarm clock5	OFF	

Additional service	402
Additional guidance	403
Address link function	165
Alarm	356
Alarm setting	364
Answer setting	63
Antenna	27

## From Easy Search

▶▶ P.4

Search for the function you frequently use or that is convenient if you know any as shown on the right.

Other things you can do	
To reduce the battery consumption	<Power Saver Mode> 101
To scan QR codes or bar codes	<Bar Code Reader> 143
To use the microSD card	<microSD Card> 305
To exchange information using infrared rays	<Infrared Data Exchange> 317
To listen to music	<MUSIC Player> 340
To use the FOMA phone as an alarm clock	<Alarm> 356
To use the FOMA phone as a calculator	<Calculator> 369
To use the FOMA phone overseas	<International Roaming> 412
To update programs	<Software Update> 465
To update security	<Scanning Function> 471

Go to page 356 where “Alarm” is explained.

## From the Tabs on the Cover

▶▶ Cover page

Search for the function you want to set in the order of “Cover” → “First page of Chapter” → “Description page” as shown on the right.

i-oppli	■
Osafu-Kaitai/TouCa	■
1Seg	■
Full Browser/PC Movie	■
Data Display/Edit/Management	■
Music&Video Channel/Music Playback	■
Convenient Functions	■
Character Entry	■
Network Services	■
PC Connection	■
Overseas Use	■
Appendix/External Devices	■
Troubleshooting	■
Index/Quick Manual	■

Multitask	<Multitask>	353
Informing You of an Incoming Call/Mail Message by Voice	<Reading Aloud>	354
Turning Power On/Off Automatically at a Specified Time	<Auto Power ON/OFF>	356
Using Alarm	<Alarm>	356
Using Calendar to Manage Schedule	<Schedule>	359
Using ToDo to Manage Schedule	<ToDo>	363
Setting Operating Conditions of Alarm	<Alarm Setting>	364



Function name  
You can find this in  
Index.

Menu number  
(See page 33)

Items shown on the  
display  
(Some items cannot  
be executed.)

Operating  
procedure  
(See page 31)

Reference display  
(Characters and settings  
are for reference.)

Operation and  
supplementary  
explanation for each  
item

Lower sub-menu item  
of the Function menu

Cautions or  
references for using  
each function

Operations related to  
the function and  
explanations for  
supplementary  
operations

Chapter title

You can  
search by  
chapter.

Options and their  
explanations

Convenient Functions

## <Alarm> Using Alarm

You can set Alarm to alert you at the specified time with an alarm tone, animation and illumination. You can store up to twelve alarms.

- 1 Press **[MENU]** **[Stationery]** **[Alarm]**  
**[Highlight an alarm and press [Edit]]**

to the following operations.

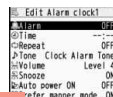

Function name	Operation/Explanation
Alarm	You can set whether to validate or invalidate the alarm. ▶ ON or OFF
Time	▶ Enter the time for sounding the alarm. ● You cannot set the same time as the time set for the stored alarm.
Tone	▶ Select a type of alarm tone ▶ Select a folder ▶ Select an alarm tone.
Volume	▶ Use <b>[Use ]</b> to adjust the volume. ● If you set "Step", the alarm tone is silent for about three seconds, and then the volume steps up every about three seconds, from Level 1 through Level 6.
Prefer manner mode	You can set the alarm tone which sounds at the specified time during Manner Mode. ▶ ON or OFF ON: ... Sounds at the same volume as set for "Alarm volume". OFF: ... Sounds at the volume set for this function.

- 2 Press **[Finish]**.

356

### Function Menu while Alarm is Displayed

Function menu	Operation/Explanation
Edit	Go to step 1 of "Using Alarm" on page 356.
Detail	You can display the stored alarm contents.
Set this	You can validate the stored alarm. ▶ YES ● You can validate also by pressing <b>[ON]</b> .
Set all	You can validate all the stored alarm. ▶ YES
Delete	▶ Delete this ▶ YES
Delete (Delete this)	▶ Delete all ▶ Enter your Terminal Security Code ▶ YES
Delete (Delete all)	

#### Information

- During a call, the alarm tone sounds at the level set for "Volume" (earpiece volume).
- When you set the power to automatically turn on and an alarm to sound, the default alarm tone sounds if the alarm with the UIM security is selected.
- Turn off the FOMA phone after setting "Auto power ON" to "OFF" when you are near electronic devices using high-precision control or weak signals, or where the use is prohibited such as in airplanes and hospitals.

#### When you set an alarm for "Alarm", "Schedule", and "ToDo"

- ▶ The icon appears on the desktop.
- ▶ ... Displayed when an alarm is set for today (except the setting for past time).
- ▶ ... Displayed when an alarm is set for tomorrow or onward only.
- If you set "Alarm" of the stored schedule event/ToDo item to "OFF", the icons are not displayed.

Note: The page above is a sample.

# Easy Search

To retrieve a desired function with simple words, refer to the following:

## To know convenient functions for making calls

To/Not to notify your phone number to the other party .....<Caller ID Notification>	45
To switch to a videophone call during a voice call .....<Switch to Videophone Call>	51
To change a volume level of the other party's voice ..... <Volume>	64
To put a call on hold during a call..... <Holding>	65

## To do the following when you cannot answer calls

To put an incoming call on hold before answering..... <On Hold>	65
To convey the message that you need to refrain from talking on the phone .....<Public Mode (Drive Mode)>	66
..... <Public Mode (Power Off)>	67
To record voice/video messages..... <Record Message Setting>	68

## To change melody or illumination

To adjust the ring volume..... <Ring Volume>	65
To change ring tones according to callers..... <Add to Phonebook>	78
To change ring tones..... <Select Ring Tone>	92
To know incoming calls by vibrator..... <Vibrator>	93
To silence the keypad sound..... <Keypad Sound>	94
To activate Manner Mode..... <Manner Mode>	96
To change colors/lighting patterns of Call indicator for incoming calls ..... <Illumination>	105

## To change/know display settings

To know the meaning of marks (icons) on the display .....<Display>	29
To change the menu display ..... <Simple Menu>	35
To change the Stand-by display (Wallpaper) ..... <Display Setting>	98
To display a calendar on the Stand-by display..... <Calendar>	98
To change the character size .....<Character Size>	111

## To make full use of mail

To send Deco-mail ..... <Deco-mail>	178
To send images ..... <Attachments>	182
To sort and save mail automatically ..... <Auto-sort>	201

## To make full use of camera

To change the shooting size..... <Image Size>	140
To save to the microSD card.....<Storage Setting (Store In)>	140
To display shot images..... <Picture Viewer>	282

### To use the FOMA phone with a sense of security

To lock the FOMA phone from away when it gets lost ....	<Omakase Lock>*1	117
To keep Phonebook entries from prying eyes .....	<Secret Mode>	120
To reject calls without a caller ID .....	<Call Setting without ID>	123
To reject calls from the phone numbers that are not in the Phonebook .....	<Reject Unknown>	124
To separately store Phonebook and other data files in preparation for their erasure .....	<Data Security Service>*2	125

\*1 This is a pay service.

\*2 This is a pay service which is available on a subscription basis.

### To make full use of 1Seg

To watch 1Seg programs .....	<Activate 1Seg>	251
To record 1Seg programs.....	<Record Video> <Record Still Images>	257
To book/To set timer recording for 1Seg programs .....	<Book Program> <Timer Recording>	259
To change settings of video and audio .....	<User Settings>	263

### Other things you can do

To reduce the battery consumption .....	<Power Saver Mode>	101
To scan QR codes or bar codes .....	<Bar Code Reader>	143
To use the microSD card .....	<microSD Card>	305
To exchange information using infrared rays.....	<Infrared Data Exchange>	317
To listen to music.....	<MUSIC Player>	340
To use the FOMA phone as an alarm clock .....	<Alarm>	356
To use the FOMA phone as a calculator .....	<Calculator>	369
To use the FOMA phone overseas.....	<International Roaming>	412
To update programs .....	<Software Update>	465
To update security .....	<Scanning Function>	471

- The operating procedures for frequently used functions are summarized in Quick Manual. (See page 486)

# Contents

How to Read/Refer to This Manual ... 1	Safety Precautions ..... 12
Easy Search.....4	Notes on Handling..... 18
Contents .....6	Intellectual Property Rights..... 21
Main Functions of FOMA P706iμ .....8	Accessories and Main Options ..... 23
Making Full Use of FOMA P706iμ!..10	

<b>Before Using the Handset</b> 25	Phone Parts and Functions, Display, Method for Selecting Menu, Simple Menu, Guide, UIM (FOMA Card), Battery, Charging, Power ON/OFF, Select Language, Initial Setting, Set Time, Caller ID Notification, Own Number, etc.
<b>Voice/Videophone Calls</b> 47	Making a Call/Videophone Call, Call Records, Chaku-moji, WORLD CALL, Hands-free, Receiving a Call/Videophone Call, Volume, Ring Volume, Public Mode (Drive Mode), Public Mode (Power Off), Record Message Setting, Chara-den, etc.
<b>Phonebook</b> 77	Available Phonebooks, Add to Phonebook (FOMA phone/UIM), Group Setting, Search Phonebook, No. of Phonebook, 2-touch Dial, Voice Dial, Data Security Service, etc.
<b>Sound/Screen/ Light Settings</b> 91	Select Ring Tone, Vibrator, Manner Mode, Display Setting, Backlight, Menu Icon Setting, Kisekai Tool, Feel * Mail, Illumination, Desktop Icon, Font, Character Size, etc.
<b>Security Settings</b> 113	Passwords, Change Security Code, Releasing PIN Lock, Lock All, Omakase Lock, Self Mode, Personal Data Lock, Keypad Dial Lock, Secret Mode, Mail Security, Call Setting without ID, Reject Unknown, etc.

<b>Camera</b> 127	Before Using Cameras, Still Image Shoot, Moving Image Shoot, Settings for Shooting Images, Setting Image Size/Image Quality, Bar Code Reader, Text Reader
<b>i-mode/i-motion/ i-Channel</b> 149	What is i-mode?, ☺ Menu, My Menu, Change i-mode Password, Enter URL, Bookmark, Screen Memo, Download, i-mode Settings, SSL Certificate, Client Certificate, What is i-motion?, What is i-Channel?, etc.
<b>Mail</b> 173	i-mode Mail, Deco-mail, Template, Attachments, Photo-sending, Mail Auto-receive, Receive Option, Check New Message, Message R/F, What is Early Warning "Area Mail"?, Chat Mail, SMS, Web Mail, etc.
<b>i-ϕpli</b> 219	What is i-ϕpli?, i-ϕpli Download, i-ϕpli Run, ☺ ϕpli Settings, Starting i-ϕpli Automatically, i-ϕpli Stand-by Display, ☺ ϕpli(microSD)
<b>OsaiFu-Keitai/ ToruCa</b> 237	What is OsaiFu-Keitai?, What is iC Transfer Service?, IC Card Content, What is ToruCa?, Obtain ToruCa Files, ToruCa Viewer, ToruCa File List/Detailed ToruCa File Display, ToruCa Settings, IC Card Lock
<b>1Seg</b> 247	What is 1Seg?, Before Using 1Seg, Channel Setting, Activate 1Seg, Program Guide i-ϕpli, Data Broadcasting, TVlink, Recording 1Seg, Book Program/Timer Recording, User Settings

<p><b>Full Browser/ PC Movie</b> 265</p>	<p>Full Browser, Full Browser Settings, What is PC Movie?, Downloading PC Movies, PC Movie Player</p>	<p><b>PC Connection</b> 405</p>	<p>Available Data Communication, Before Using Data Communication, Preparation Flow for Data Transfer (OBEX™ Communication), Preparation Flow for Data Communication, AT Command, CD-ROM, DOCOMO Keitai Datalink</p>
<p><b>Data Display/Edit/ Management</b> 279</p>	<p>Data Box, Picture Viewer, i-motion Player, Video Player, Chara-den, Melody Player, Kisekae Tool, microSD Card, Voice Recorder, PDF Viewer, Document Viewer, etc.</p>	<p><b>Overseas Use</b> 411</p>	<p>Outline of International Roaming (WORLD WING), Available Services, Confirmation for Using, Making a Call at the Country You Stay, Receiving a Call, Set Roaming Guidance, Network Services, etc.</p>
<p><b>Music&amp;Video Channel/ Music Playback</b> 331</p>	<p>What is Music&amp;Video Channel?, Set Program, Playing Back/Operating Programs, Playing Back Music, Saving Music Files, MUSIC Player, Playlist</p>	<p><b>Appendix/ External Devices/ Troubleshooting</b> 421</p>	<p>Function List, Options and Related Equipment, Troubleshooting, Error Messages, Warranty and Maintenance Services, i-mode Trouble Diagnosis Site, Software Update, Scanning Function, Specifications, SAR, Export Administration Regulations, etc.</p>
<p><b>Convenient Functions</b> 351</p>	<p>Multiaccess, Multitask, Reading Aloud, Alarm, Schedule, ToDo, Own Number, Voice Memo, Movie Memo, Call Data, Calculator, Text Memo, UIM Operation, Reset Settings, Initialize, etc.</p>	<p><b>Index/ Quick Manual</b> 477</p>	<p>Index, Quick Manual, Quick Manual "For Overseas Use"</p>
<p><b>Character Entry</b> 375</p>	<p>Character Entry, Mode 1 (5-touch), Common Phrases, Cut/Copy/Paste, Own Dictionary, Learned Words, Download Dictionary, Mode 2 (2-touch), Mode 3 (NIKO-touch)</p>		
<p><b>Network Services</b> 385</p>	<p>Check New Messages, Voice Mail, Call Waiting, Call Forwarding, Nuisance Call Blocking, Caller ID Request, Dual Network, Service Numbers, Remote Control, Multi Number, 2in1, OFFICEED, etc.</p>		

## Main Functions of FOMA P706iμ

**FOMA (Freedom Of Mobile multimedia Access) is the name of the DOCOMO service based on the W-CDMA format, authorized as one of the world's standards for third-generation mobile telecommunication systems (IMT-2000).**

### ◆ Remarkable i-mode! ▶▶ P.150

i-mode is an online service that enables you to get useful information from i-mode menu sites (programs) or i-mode web pages. This service also enables you to send or receive mail messages with ease.

### ◆ i-mode mail/Deco-mail/Deco-mail pictogram ▶▶ P.174, P.178, P.280

Besides mail text, you can attach photos or movie files, etc. The FOMA phone supports Deco-mail/Deco-mail pictograms, so you can change the character color, character size, and background color of mail text, and insert images and moving pictographs.

### ◆ International Roaming ▶▶ P.412

You can use your FOMA phone, phone number, and mail address overseas as they are. (Supported only in 3G area)  
Voice calls, videophone calls, i-mode, i-mode mail, SMS, and network services are available.

### ◆ High-Speed Area Supported ▶▶ P.406

FOMA High-Speed Area is supported so that high speed communication is available with download speed of up to 3.6 Mbps and upload speed of up to 384 kbps.

※The maximum speeds of 3.6 Mbps and 384 kbps denote the maximum speeds specified by the technical standards. The actual speeds differ depending on the extent how networks are congested or communication environment. Your communication is enabled at the maximum 384 kbps of both upload and download speeds when you are out of the FOMA High-Speed area, or are connecting to an access point that does not support HIGH-SPEED such as mopera.

### ◆ Mega i-ϕpli ▶▶ P.220

You can enjoy playing games or update stock price information or weather forecasts automatically. As the large capacity mega i-ϕpli is supported, you can enjoy playing high-resolution 3D games and full-length role playing games.

### ◆ Chaku-uta Full®/Uta-hodai/Music&Video Channel®/Video Clips ▶▶ P.170, P.332, P.338, P.340

This FOMA phone supports Chaku-uta Full® that enables you to download a whole music file and Uta-hodai that enables you to enjoy listening music as much as you like at a flat rate.

This FOMA phone also supports Music&Video Channel that, just by setting up beforehand, automatically downloads music programs and programs containing moving images in the night. Further, this FOMA phone supports up to 10 Mbytes of i-motion movies, so it also supports Video Clip that enables you to enjoy a whole music clip file.

- "Chaku-uta Full" is a registered trademark of Sony Music Entertainment Inc.
- ※ This is a pay service which is available on a subscription basis.

### ◆ Osaifu-Keitai/ToruCa ▶▶ P.238, P.240

By downloading Osaifu-Keitai compatible i-ϕpli, you can replenish electronic money from a site into the IC card in the FOMA phone and check your account for the balance and usage details. In addition, the "DCMX" i-ϕpli program that provides the DOCOMO credit service is pre-installed. Further, "iC transfer service" is supported so that you can easily move data from the existing IC card to a new one when you replace your FOMA phone such as at the time of phone model change.  
ToruCa is an electronic card that you can obtain from scanning devices or sites and can easily exchange using mail or infrared data exchange.

### ◆ Kisekae Tool ▶▶ P.103, P.304

You can change the Stand-by display or Menu display to your favorite one at a time. You can change the order of displayed menus on P706iμ according to the frequency of use to customize the Menu display as you like.

### ◆ Image Stabilizer ▶▶ P.141

You can shoot still images with less blur.

**◆Feel \* Mail ▶▶P.104**

Animation of 45 characters and illumination reproduce the atmosphere of mail messages. Pleasant animation appears or illumination lights according to the contents of mail message.

**◆Wide QVGA Display**

You can display still or moving images in the Wide QVGA (240 dots x 427 dots) display of approx. 3.0 inches, and you can enjoy watching 1Seg programs on the impressive display. Also, the light sensor automatically adjusts the backlight in accordance with the ambient brightness, and the LCD AI compensates the image quality in accordance with the brightness.

**◆One-push Open ▶▶P.42****■One-push Answer ▶▶P.64**

When a call comes in, just press the one-push open button, and you can open the FOMA phone to answer the call.

**■Recv. Mail/Call at Open ▶▶P.101**

When a missed call or new mail message is found, just press the one-push open button, and you can open the FOMA phone to display the detailed Missed Call display or the Inbox list.

**◆View Blind ▶▶P.102**

You can make the display hard to see from an angle. You can use the FOMA phone without being gazed at by others.

**◆Document Viewer ▶▶P.327**

On your FOMA phone, you can display Microsoft Word files, Microsoft Excel files, and Microsoft PowerPoint files created by personal computers.

**◆Voice Recorder ▶▶P.322**

You can record your voice as a substitute for taking notes. You can repeatedly play it back, so it is convenient to record the proceedings at a meeting, etc.

**◆Security Settings ▶▶P.113**

Various settings such as the lock functions and security settings for "safety" are available.

**■Omakase Lock ▶▶P.117**

When you have lost the FOMA phone, you can lock the FOMA phone and release it by contacting DOCOMO.

For inquiries, see the back page of this manual.

Omakase Lock is a pay service<sup>※</sup>.

※ You are not charged if you apply for this service at the same time as applying for the suspension of the use or during the suspension.

● Note that Omakase Lock might be activated by an offer from the contractor of the FOMA phone when the contractor and the user of the FOMA phone differ.

**■Data Security Service ▶▶P.125**

This service enables you to save Phonebook entries, images, and mail messages from your FOMA phone to the Data Storage Center, and restore the saved data, when you lost your FOMA phone or in other cases, to your FOMA phone from the Data Storage Center. Further, you can edit or manage data held at the Data Storage Center using your personal computer and can reflect the edited data to your FOMA phone. For details on Data Security Service, refer to "Mobile Phone User's Guide [i-mode] FOMA version". For inquiries, see the back page of this manual.

Data Security Service is a pay service that is available on a subscription basis.

**◆Network Services ▶▶P.385**

- Voice Mail Service (Charged)
- Call Forwarding Service (Free)
- Dual Network Service (Charged)
- 2in1 (Charged)
- Call Waiting Service (Charged)
- Nuisance Call Blocking Service (Free)
- Multi Number (Charged)

※ These services are available on a subscription basis except for Nuisance Call Blocking Service.

## Making Full Use of FOMA P706i!

### ◆Videophone ▶▶ P.48

You can talk with a person who is away from you, seeing each other's images. By the default setting, the substitute image is sent to the other party. You can switch from the substitute image to the image through your camera to send the surrounding scenery. You can switch, without disconnecting, from an ordinary voice call to a videophone call.

### ◆i-Channel ▶▶ P.171

i-Channel distributes graphical information such as news and weather forecast. By selecting your favorite channel from the Channel list, you can obtain detailed expressive information with Flash movies (see page 152).

- This is a pay service which is available on a subscription basis.
- The service is provided only in Japanese.

Before contract

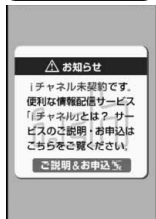

After contract

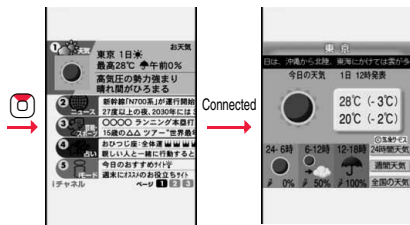
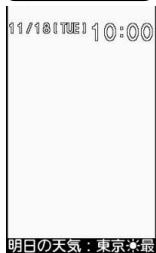

### ◆1Seg ▶▶ P.248

You can watch 1Seg (terrestrial digital TV broadcasting service for mobile objects) programs. You can display captions and data broadcasting, and record a program while watching it. Use Book Program or Timer Recording not to miss an opportunity to watch or record programs.

While watching a 1Seg program, you can compose i-mode mail messages or check the sent/received i-mode mail messages by using multiple windows as well.



### ◆Chaku-moji ▶▶ P.54

While calling up the other party, you can have your message displayed on his/her Call Receiving display. The receiving end can know your subject/feeling by reading the message before answering the call.

### ◆Kisekai Tool/Direct Menu ▶▶ P.103, P.304

This FOMA phone comes with "Direct Menu" that enables you to easily access the functions and services you frequently use.

The menus are categorized into four that are arranged at top, bottom, left, and right. The "LAST 10" button is located at the center, which automatically displays 10 items of the functions and services you used most recently. Five categorized arrangements link with the command navigation keys, so it is easy to remember the arrangements and operate the menus.

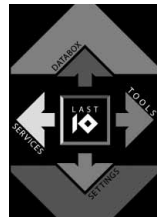

- ☐ SERVICES [メール (Mail), i モード (i -mode), i アプリ (i -appli), MUSIC, ワンセグ (1Seg), おサイフケータイ (Osaifu-Keitai), etc.]
  - ☐ TOOLS [アラーム (Alarm), 電卓 (Calculator), テキストメモ (Text memo), スケジュール (Schedule), 赤外線受信 (Receive Ir data), etc.]
  - ☐ SETTINGS [設定 (Settings), サービス (Services), 自局番号表示 (Own number)]
  - ☐ DATABOX [マイピクチャ (My picture), etc.]
  - ☐ LAST10 (automatically displays 10 items of the menus you used most recently.)
- ※ Functions are pre-installed by default.



◆2in1 ▶▶ P.396

This service enables you to have two numbers/two mail addresses on your single FOMA phone and to use your FOMA phone as if you were using two sets, by using the dedicated mode function. You can sort Phonebook entries, mail boxes, dialed/received call records, and Stand-by displays into "A mode" and "B mode" to manage them separately. You can also use "Dual mode" to simultaneously manage both A and B modes.

- This is a pay service which is available on a subscription basis.

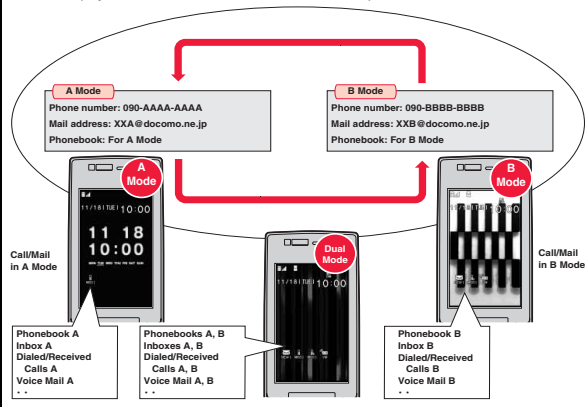

◆MUSIC Player ▶▶ P.340

On a single player, you can play back and enjoy Chaku-uta Full® music files, Windows Media® Audio (WMA) files, and SD-Audio files.

You can download Chaku-uta Full® music files from sites and may be able to display their images and lyrics while playing them back.

In the case of SD-Audio or WMA files, you can obtain your favorite music files from music CDs or Internet web pages and save them on the microSD card by using your personal computer.

You can save music files also by using the Napster® application program.



◆The Stand-by and Menu displays by TGB-design ▶▶ P.98, P.103

The Stand-by Flash movies/Menu displays by TGB-design, the designer team that plays an active role in various fields, are pre-installed. Enjoy a new motion by the graphic design which smoothly shifts from the Stand-by display to the Menu display with the sense of unity.

Each setting can be changed from "Stand-by display" of "Display setting" or "Menu icon setting".

■Examples of the contents by TGB-design

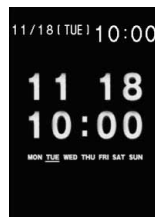

Stand-by display



Main Menu display



Mail Menu display

■Combination example of "Stand-by display" and "Menu icon setting"



Stand-by display	Menu icon setting
TGB-flash01	TGB-menu01
TGB-flash02	TGB-menu02
TGB-flash03	TGB-menu03
TGB-flash04	TGB-menu04

Further, "TGB-interface" that can collectively set "Stand-by display", "Menu icon setting", and ring melodies is pre-installed in Kisekai Tool.





※ The contents by TGB-design such as ring tones and an i-motion movie are pre-installed as well.

## Safety Precautions Always follow the safety precautions.

- Before using the FOMA phone, read these safety precautions carefully so that you can use it correctly.  
After reading the precautions, keep them in a safe place.
- Be sure to observe these safety precautions because they are designed to protect you or those around you from causing injury and to avoid unnecessary damage to the property.
- The symbols below indicate the levels of danger or damage that can be caused if the particular precautions are not observed.

	<b>Danger</b>	This symbol indicates that incorrect handling will almost certainly cause death or serious injury.
	<b>Warning</b>	This symbol indicates that incorrect handling poses a risk of causing death or serious injury.
	<b>Caution</b>	This symbol indicates that incorrect handling poses a risk of causing injury or damage to the product or property.

### ■ The following symbols show specific directions:

	Denotes things not to do. (Prohibition)
Don't	
	Denotes not to disassemble.
Do not disassemble	
	Denotes not to touch with wet hands.
Not wet hands	
	Denotes not to use where it could get wet or not to wet it.
Avoid Water	
	Denotes mandatory instructions (matters that must be complied with).
Do	
	Denotes to pull the power plug out of the outlet.
Pull the power plug out	

### ■ "Safety Precautions" are divided into the following six sections:

General precautions for FOMA phone, batteries, adapters/chargers, and UIM .....	P.13
Precautions for FOMA phone .....	P.14
Precautions for batteries .....	P.16
Precautions for adapters/chargers.....	P.16
Precautions for UIM.....	P.17
Notes on using near electronic medical equipment .....	P.18

## General precautions for FOMA phone, batteries, adapters/chargers, and UIM



### Danger



Don't

**Do not use, store or leave the FOMA phone and its accessories in places with a high temperature such as near fire or places exposed to direct sunlight, or in cars under the blazing sun.**

The devices could be deformed or malfunction, or the battery may leak, overheat, burst, or catch fire, thus resulting in the deterioration of performance and shortening of the life of devices.

Also, part of the case could get heated, causing bare skin burns.



Do not disassemble

**Do not disassemble, modify or solder the FOMA phone or accessories.**

Accidents such as fire, injury, or electric shock, or malfunction may result. The battery may leak, overheat, burst or catch fire.



Avoid Water

**Do not wet the FOMA phone or accessories.**

If liquids such as water or pet urine get onto them, overheating, electric shock, fire, malfunction, injury or others may result. Pay attention to the place of use and the way of handling.



Do

**With your FOMA phone, use the batteries and adapters/chargers specified by NTT DOCOMO, INC.**

If you use any type of battery, adapter or charger other than the specified one, your FOMA phone, battery or other accessories may leak, overheat, burst, catch fire or malfunction.

Battery Pack P17

FOMA AC Adapter 01/02

FOMA AC Adapter 01 for Global use

FOMA DC Adapter 01/02

Desktop Holder P26

FOMA Dry Battery Adapter 01

FOMA Portable Charging Adapter 01

FOMA USB Cable with Charge Function 01/02

※For other compatible products, contact a handling counter such as a DOCOMO shop.



### Warning



Don't

**Do not place the batteries, the FOMA phone, adapters/chargers, or UIM in cooking appliances such as microwave ovens or high-pressure containers.**

The battery may leak, overheat, burst, or catch fire. The FOMA phone or the adapter/charger may overheat, smoke, or catch fire, or its circuit parts may become damaged.



Don't

**Do not throw the FOMA phone or accessories, or subject them to severe shocks.**

The battery may leak, overheat, burst, or catch fire. Also, malfunction or fire may result.



Don't

**Be careful not to let electroconductive materials (metal pieces, pencil leads etc.) contact with the charging terminal or connector terminal. Also, make sure that those are not entered into the inside of the FOMA phone.**

Short-circuit could cause fire or malfunction of the FOMA phone.



Do

**When you are in a place such as a gas station where flammable gas is generated, turn off the FOMA phone, and never do charging. Otherwise, catching fire may result.**

Ensure that you use Osaifu-Keitai with the FOMA phone turned off when you are in the vicinity of the gas station. (When IC Card Lock is set, turn off the power with the lock released.)



Do

**If odor, overheat, discoloration, or deformation is detected during use, battery charge, or storage, immediately observe the following:**

- 1. Pull the power plug out of the outlet or cigarette lighter socket.**
- 2. Turn off the power to the FOMA phone.**
- 3. Remove the battery pack from the FOMA phone.**

If you use the FOMA phone and its accessories as they are, overheat, burst, or catching fire could result or the battery could leak.



## Caution



Don't

**Do not place the FOMA phone or accessories on unstable locations such as wobbly tables or slanted locations.**

The FOMA phone or accessories may fall, resulting in injury or malfunction.



Don't

**Do not store in humid or dusty places, or in high temperature environments.**

Malfunction may result.



Do

**If children use the FOMA phone or accessories, a guardian should explain the safety precautions and correct operations. The guardian should also make sure that the instructions are followed during use.**

Otherwise, injury may result.



Do

**Keep out of the reach of babies and infants.**

Accidental swallowing or injury may result.



Do

**Be especially careful when you use the FOMA phone for a long time with the adapter/charger connected.**

If you use i-oppli programs, talk on the videophone, watch 1Seg programs and so on for a long time during charging, the temperature of the FOMA phone, battery pack, or adapter/charger might rise.

If you directly touch the part of high temperature continuously, redness, itching, rash, or low-temperature bare skin burns may result depending on your physical conditions or predisposition.

## Precautions for FOMA phone



## Warning



Don't

**Do not directly point the infrared data port at someone's eyes during transmission.**

His/her eyes may possibly be affected. Other infrared devices may operate erroneously if the infrared data port is pointed at them during transmission.



Don't

**Do not put the FOMA phone in the place where it could be affected by an expanded airbag, e.g., on the dashboard.**

If the airbag expands, the FOMA phone could hit you and others, causing accidents such as injury and the FOMA phone could malfunction and become damaged.



Don't

**If you have any implanted electronic medical equipment, do not place your FOMA phone in a chest pocket or inner pocket.**

If the FOMA phone is positioned close to electronic medical equipment, it may cause that equipment to malfunction.



Don't

**Do not allow liquids such as water, or foreign materials such as metal pieces or flammable materials to get into the UIM or microSD card slot of the FOMA phone.**

Fire, electric shock or malfunction may result.



Do

**Turn off the FOMA phone in places where use is prohibited such as in airplanes and hospitals.**

Otherwise, electronic devices and electronic medical appliances may be adversely affected. If the Auto Power ON function is set, deactivate the setting, then turn the power off. For use inside medical facilities, make sure that you comply with their regulations. You may be punished for using the FOMA phone in airplanes, which is prohibited by law.



Do

**When talking with the FOMA phone set to Hands-free, be sure to keep the FOMA phone away from your ear.**

**Further, when you play games or play back music with the earphone/microphone connected, adjust the sound volume to moderate volume.**

The excessive sound volume impairs your hearing.

Further, accidents may result due to the hardness of hearing of surrounding sound.



Do

**For those with weak heart conditions, the vibrator and ring volume must be adjusted carefully.**

Those functions may cause an effect on the heart.



Do

**If thunder starts to rumble while you are using the FOMA phone outdoors, turn off the power and move to a safe place.**

Otherwise, you could be struck by lightning or suffer an electric shock.



Do

**Turn off the FOMA phone when near electronic devices using high-precision control or weak signals.**

The FOMA phone may possibly cause these devices to malfunction.

※ Electronic devices that may be affected:

Hearing aids, implanted cardiac pacemakers, implanted defibrillators, other medical electronic devices, fire alarms, automatic doors and other automatically controlled devices. If you use an implanted cardiac pacemaker, implanted defibrillator or any other electronic medical device, consult the manufacturer or retailer of the device for advice regarding possible effects from the radio waves.



Do

**If the display part or camera lens is broken, be careful about broken glasses or the exposed interior of the FOMA phone.**

Plastic panels are used for the surfaces of the display part and camera lens so that glasses do not easily get scattered, however, pay attention not to erroneously touch the broken part or interior. Otherwise, injury may result.



## Caution



Don't

**Do not swing the FOMA phone by its strap.**

The FOMA phone may hit you or persons around you, and accidents such as injury or malfunction and damage may result.



Don't

**Do not place magnetic cards or similar objects near the FOMA phone or between phone parts.**

Magnetic data on cash cards, credit cards, telephone cards and floppy disks, etc. may be deleted.



Don't

**Do not bring magnetic substances close to your FOMA phone.**

Strong magnetic items might cause in erroneous operation.



Don't

**If you erroneously break the display part and then crystal liquid gets leaked, never take or suck the liquid to or into your mouth, or apply to skin.**

**If the crystal liquid gets into the eyes or mouth, immediately rinse it out with clean water and then seek medical attention. When it adheres to your skin or clothes, immediately wipe it away with alcohol etc., and then rinse it out with water and soap.**

Otherwise, the loss of eyesight or injury to your skin may result.



Don't

**Do not bring your ears close to the speakers while a ring tone sounds or a melody is played back from the FOMA phone.**

Otherwise, your hearing could be impaired.



Don't

**Do not open the FOMA phone by pressing the one-push open button near persons around you or your face.**

The FOMA phone may hit you or persons around you, causing accidents and injuries.



Do

**Electronic devices in some types of cars can be affected by use of the FOMA phone.**

For safety's sake, make sure not to use the FOMA phone inside such cars.



Do

**Itching, rash or eczema may be caused depending on your physical conditions or predisposition. If an abnormality occurs, stop using the FOMA phone immediately, and then seek medical attention.**

Metals are used for the following parts:

Where it is used	Material	Finishing
Topside case Back cover	Stainless	Baking finish
Side ▲ key Side ▼ key Metal part of the one-push open button	ABS	Chrome-plated finish with nickel-plated ground
Charging terminal	Copper alloy	Gold-plated finish with nickel-plated ground



Do

**Be careful not to get your finger or a strap caught in the parts when you close or open the FOMA phone.**

Accidents such as injury or damage may result.



Do

**When you watch a 1Seg program, watch in a place bright enough taking a certain distance from the display.**

Otherwise, your visual acuity could be reduced.



Do

The back cover is made of metal, so handle it with care.

You may hurt your hand or fingers.

### Precautions for batteries

- Check the description on the label of the battery pack for the type of battery.

Description	Type
Li-ion	Lithium-ion battery



### Danger



Don't

Do not let any metal object such as a wire come in contact the battery terminals. Also do not carry or store the battery together with any metal objects like a necklace.

The battery may leak, overheat, burst or catch fire.



Don't

Do not use excessive force to attach the battery to the FOMA phone even when you cannot attach it successfully. Also, check that the battery is the right way round when you attach it.

The battery may leak, overheat, burst or catch fire.



Don't

Do not throw the battery into fire.

The battery may leak, overheat, burst or catch fire.



Don't

Do not pierce it with nails, hit it with a hammer, or step on it.

The battery may leak, overheat, burst or catch fire.



Do

If the battery fluid gets into your eyes, do not rub them. Flush your eyes with clean water and seek medical attention immediately.

Otherwise, the loss of eyesight may result.



### Warning



Don't

When any abnormality due to external shock such as the deformation or scratches by dropping is found on the battery pack, immediately stop using it.

The battery may leak, overheat, burst, or catch fire. Also, malfunction or fire may result.



Do

If charging is not completed at the end of the specified charging time, stop charging.

Otherwise, the battery may leak, overheat, become damaged or catch fire.



Do

Immediately stop using the FOMA phone and keep it away from fire if the battery leaks or emits an odor.

The leaked battery fluid may ignite, causing fire or burst.



Do

Be careful that your pets do not bite into the battery pack.

The battery may leak, overheat, burst, or catch fire. Also, malfunction or fire may result.



### Caution



Don't

An exhausted battery should not be disposed of with other waste.

The battery may catch fire or damage the environment. After insulating the battery terminals with tape, take the unneeded battery to a handling counter such as a DOCOMO shop or dispose of it in accordance with local waste disposal regulations.



Don't

Do not charge the wet battery.

The battery pack may overheat, catch fire, or burst.



Do

If the battery fluid comes in contact with skin or clothes, immediately stop using, then rinse it out thoroughly with clean water.

Skin injury may result.

### Precautions for adapters/chargers



### Warning



Don't

Do not use a damaged adapter/charger cord or power cord.

Electric shock, overheating or fire may result.



Don't

Do not use the AC adapter and desktop holder in steamy places such as a bathroom.

Electric shock may occur.



Don't

**The DC adapter is for use only in a negative (-) grounded vehicle. Do not use it in a positive (+) grounded vehicle.**  
Fire may result.



Don't

**If it starts to thunder, do not touch the FOMA phone and adapter/charger.**  
You might be struck by lightning or suffer an electric shock.



Don't

**Never short-circuit the charging terminal when the adapter is plugged into the power outlet or cigarette lighter socket. Also, never touch the charging terminal with fingers or other bare skin.**  
Fire, malfunction, electric shock or injury may result.



Don't

**Place the charger and desktop holder on a stable location during charging. Do not cover or wrap the charger and desktop holder in cloth or bedding.**  
The FOMA phone may drop off, or the charger and desktop holder may overheat, causing fire or malfunction.



Don't

**Do not place something heavy on the adapter/charger cord and power cord.**  
Electric shock or fire may result.



Not wet hands

**Do not touch the power cord of the adapter/charger, or power outlet with wet hands.**  
Electric shock may result.



Do

**Use the adapter/charger at the specified V AC.**  
If you use it at a wrong voltage, fire or malfunction may result. When using the FOMA phone overseas, use FOMA AC adapter available overseas.  
AC adapter: 100 V AC  
DC adapter: 12/24 V DC  
[For negative (-) grounded vehicles only]  
AC adapter available overseas: 100 V to 240 V AC  
[Connect only to household AC outlet]



Do

**If a fuse of the DC adapter has blown, replace it with a specified fuse.**  
If you use an unspecified fuse, fire or malfunction may result. For the specified fuse, refer to each instruction manual.



Do

**Keep the power plugs dust-free.**  
Otherwise, fire may result.



Do

**When pulling the AC adapter into the power outlet, firmly plug it in, taking care not to contact with metal straps or the like.**  
Otherwise, electric shock, short-circuit or fire may result.



Do

**When removing the adapter/charger out of the outlet or cigarette lighter socket, do not forcibly pull the adapter/charger cord or power cord, instead take hold of the power plug and then pull.**  
If you pull the plug out by the cord, the cord may be damaged, which could result in electric shock or fire.



Pull the power plug out

**When the adapter/charger is not to be used for a long period of time, unplug the power cord from the outlet.**  
Otherwise, electric shock, fire, or malfunction may result.



Pull the power plug out

**If liquids such as water get in the charger, unplug the power cord immediately from the outlet or cigarette lighter socket.**  
Otherwise, electric shock, smoke or fire may result.



Pull the power plug out

**Before cleaning, pull the power plug out of the outlet or cigarette lighter socket.**  
Otherwise, electric shock may result.

## Precautions for UIM



## Caution



Do

**Be careful not to touch the cut surface of the UIM (IC portion) when removing it.**  
You may hurt your hand or fingers.

## Notes on using near electronic medical equipment

- The description below meets “Guidelines on the Use of Radio-communication Equipment such as Cellular Telephones – Safeguards for Electronic Medical Equipment” by the Electromagnetic Compatibility Conference Japan.



### Warning



Do

#### Comply with the following in hospitals or health care facilities:

- Do not carry the FOMA phone into operating rooms, intensive care units (ICU) or coronary care units (CCU).
- Turn off the FOMA phone in hospital wards.
- If there is any electronic medical equipment near you, turn off the FOMA phone even when in a location such as a lobby.
- Comply with any regulations of hospital and health care facilities instructing you not to use or carry in a mobile phone.
- If the Auto Power ON function is set, deactivate the setting, then turn the power off.



Do

#### Turn off the FOMA phone in crowded areas such as inside trains during rush hour, as someone with an implanted cardiac pacemaker or implanted defibrillator may be near you.

Operation of an implanted cardiac pacemaker or implanted defibrillator can be affected by radio waves.



Do

#### If you use an implanted cardiac pacemaker or implanted defibrillator, use the mobile phone 22 cm or more away from an implanted cardiac pacemaker or implanted defibrillator.

Operation of an implanted cardiac pacemaker or implanted defibrillator can be affected by radio waves.



Do

#### Patients using electronic medical equipment other than implanted cardiac pacemakers or implanted defibrillators (outside medical establishments for treatment at home, etc.) should check the influence of radio waves upon the equipment by consulting its manufacturer.

Operation of electronic medical equipment can be affected by radio waves.

## Notes on Handling

### General notes

#### ■ Do not wet the equipment.

The FOMA phone, battery, adapter/charger, and UIM are not waterproofed. Do not use them in environments, which are high in humidity such as in bathrooms, and do not allow them to get wet from rain. Furthermore, if carrying them against your body, they become moist due to perspiration and the internal parts may become corroded, causing malfunction. If the parts are found to have been damaged due to exposure to the liquids, any repairs will not be covered by warranty, or repairs may not be possible. This may be repaired at a cost if repairs are possible.

#### ■ Use a dry soft cloth such as the one for cleaning glasses to clean the equipment.

- The screen of the FOMA phone sometimes has a special coating so that they are easier to see. If you rub it roughly with a dry cloth, it might be scratched. Take care of the way of handling, and use only a dry, soft cloth such as the one for cleaning glasses. If the screen is left with water drop or stain adhered, smear may be generated or the coating might peel off.
- Do not use alcohol, thinner, benzene, detergent or other solvents for cleaning, otherwise the printing may be removed or discoloration may result.

#### ■ Occasionally clean the terminals of the equipment using a dry cotton swab.

If the terminals become soiled, the connection might deteriorate so that the power turns off or the battery does not charge fully. Wipe the terminals with a dry cloth or cotton swab.



**■ Do not place the FOMA phone near an air conditioner outlets.**

Condensation may form due to rapid changes in temperature, and this may corrode internal parts and cause malfunction.

**■ Do not apply excessive force onto the FOMA phone and battery pack.**

If you put the FOMA phone in a bag along with many other articles or sit with the FOMA phone in a clothes pocket, the display, internal circuitry and the battery pack could be damaged or malfunction. Also, if an external device is left connected to the connector terminal, the connector could be damaged, or malfunction.

**■ Carefully read each instruction manual attached to the FOMA phone, adapter/charger, or desktop holder.**

**■ Do not rub or scratch the display part with metals.**  
Doing so might cause damage to the part, resulting in trouble or malfunction.

**Notes on handling the FOMA phone**

**■ Avoid using in extremely high or low temperatures.**

The FOMA phone should be used within a temperature range of 5°C to 35°C and a humidity range of 45% to 85%.

**■ The FOMA phone, if operated near landline phones, television sets, radios or other devices that are in use, may affect them. You should operate your FOMA phone as far away from such equipment as possible.**

**■ It is recommended that you make separate notes of the information stored in the FOMA phone and keep such notes in a safe place.**  
We take no responsibility for any loss of the stored data items.

**■ Do not insert an external device to the connector terminal (Earphone-Microphone terminal) at a slant when connecting, and do not pull it out when it is inserted.**  
Malfunction or damage may result.

**■ Make sure that nothing, such as a strap, gets caught between the parts of the FOMA phone when you close it.**

Otherwise, malfunction or damage may result.

**■ The FOMA phone becomes warm during use or charging but this is not an abnormality. Use the FOMA phone as it is.**

**■ Do not leave the camera in places exposed to direct sunlight.**

Pixels may be discolored or burns may result.

**■ Usually, put the cover of the connector terminal and microSD card slot to use the FOMA phone.**

Dust or water might enter into the FOMA phone, causing malfunction.

**■ Do not use the FOMA phone with the back cover left removed.**

The battery pack might come out, or malfunction or damage may result.

**■ Do not apply an excessively thick sticker onto the surfaces of the display, keys, or buttons.**  
Malfunction may result.

**■ While you are using the microSD card, never take it off or turn off the power to the FOMA phone.**

Data may be erased or malfunction may result.

**Notes on handling batteries**

**■ Batteries have a limited life.**

Though it varies depending on the usage state, you are advised to replace the battery if its usable time is extremely short even when you fully charge it. Make sure that you buy the specified battery.

**■ Charge the battery in a place with an appropriate ambient temperature of 5°C to 35°C.**

**■ Make sure that the battery is charged when you use the FOMA phone for the first time or have not used it for a long period of time.**

**■ The usable time of the battery differs depending on the usage environment or its remaining life.**

**■ Depending on how the battery pack is used, it might swell as its operating life becomes short, but this is not a problem.**

**■ Do not store or leave the empty battery pack.**  
The performance and operating life of the battery pack might be lowered or shortened.

**Notes on handling chargers/adapters**

**■ Charge the battery in a place with an appropriate ambient temperature of 5°C to 35°C.**

**■ Charge the battery where:**

- There is very little humidity, vibration, and dust.
- There are no landline phones, television sets or radios nearby.

**■ During charging, the adapter/charger may become warm. This is not an abnormality, so continue charging.**

**■ Do not use the DC adapter for charging the battery when the car engine is not running.**  
The car battery could go flat.

**■ When using the power outlet having the disengaging prevention mechanism, observe the instructions given in that instruction manual.**

**■ Do not give a strong shock. Also, do not deform the charging terminal.**  
Malfunction may result.

## Notes on handling the UIM

- Never use more force than necessary when inserting/removing the UIM.
- The UIM may become warm during use, but this is not a sign of a malfunction. Continue using it as it is.
- The warranty does not cover damage caused by inserting the UIM into some other types of IC card reader/writer.
- Always keep the IC portion clean.
- Use a dry soft cloth such as the one for cleaning glasses to clean the equipment.
- It is recommended that you make separate notes of the information stored on the UIM and keep such notes in a safe place.  
We take no responsibility for any loss of the stored data items.
- For the environmental protection, bring any unneeded UIMs to a handling counter such as a DOCOMO shop.
- Avoid using in extremely high or low temperatures.
- Do not damage, carelessly touch, or short-circuit the IC.  
Data might be lost or malfunction may result.
- Do not drop the UIM or subject it to strong impacts.  
Malfunction may result.
- Do not bend the UIM or place something heavy on it.  
Malfunction may result.

- Into the FOMA phone, do not insert the UIM with a label or sticker pasted.

Malfunction may result.

## Notes on handling the FeliCa reader/writer

- The FeliCa reader/writer function on the FOMA phone uses very weak radio waves which do not require to be licensed as radio stations.
- The FeliCa reader/writer is operated on the 13.56 MHz frequencies. When you use another reader/writer nearby, take enough distance between your FOMA phone and the reader/writer. Further, ensure that there are no radio stations that use the same frequencies.

## Caution

- Do not use the modified FOMA phone. Using a modified FOMA phone infringes the Radio Law.

The FOMA phones are granted technical regulations conformity certification as the specified radio equipment under the Radio Law and bear a "technical conformity mark" (㊞) on the nameplate as evidence of conformity. Unscrewing the FOMA phone and modifying internal components void the technical regulations conformity certification. Do not use the FOMA phone in this state, which infringes the Radio Law.

- Be especially careful not to operate the FOMA phone while driving.

You will be imposed punishment if you use the mobile phone in your hand while driving. If you answer a call out of necessity, tell the caller with Hands-free that you will call him/her back, park your car to somewhere safe, and then dial.

- Use the FeliCa reader/writer functions in Japan only.

The FeliCa reader/writer functions on the FOMA phone have been authorized in compliance with the radio transmission standards in Japan.

You might be imposed punishment if you use them overseas.

# Intellectual Property Rights

## Copyrights and Portrait Rights

You have no right to copy, modify, or distribute the contents such as text, images, music, or software programs downloaded from web pages on the Internet, or images shot by the cameras of this product without permission from the copyright holder except for when the copy or quote is for personal use that is allowed by the copyright law.

Note that it may be prohibited to shoot or record live performances or exhibitions even for personal use. Make sure that you refrain from shooting portraits of other persons and distributing such portraits over the Internet without consent, as this violates portrait rights.

## Trademarks

- "FOMA", "mova", "i-mode", "i-opppli", "i-opppliDX", "i-motion", "Deco-mail", "Chaku-motion", "Chara-den", "ToruCa", "mopera", "mopera U", "WORLD CALL", "Dual Network", "FirstPass", "visualnet", "V-live", "i-Channel", "DCMX", "iD", "Security Scan", "i-motion mail", "i-area", "Short Mail", "WORLD WING", "Public mode", "DoPa", "sigmarion", "musea", "IMCS", "OFFICEED", "2in1", and the logos of "FOMA", "i-mode", "i-opppli", "DCMX", "iC", "iD", "Music&Video Channel", and "HIGH-SPEED" are trademarks or registered trademarks of NTT DOCOMO, INC.
- "Catch Phone (Call waiting service)" is a registered trademark of Nippon Telegraph and Telephone Corporation.
- Free Dial logo mark is a registered trademark of NTT Communications Corporation.
- McAfee® is registered trademarks or trademarks of McAfee, Inc. and/or its affiliates in the US and/or other countries.
- G-GUIDE, G-GUIDE MOBILE and their logos are registered trademarks in Japan of U.S. Gemstar-TV Guide International, Inc. and/or its affiliates.
- QuickTime is a registered trademark of Apple Inc., in the US and other countries.
- NAVIDIAL and NAVIDIAL logo mark are trademarks of NTT Communications Corporation.
- Microsoft®, Windows®, and Windows Vista® are trademarks or registered trademarks of Microsoft Corporation in the United States and other countries.
- Windows Media® is either a registered trademark or trademark of Microsoft Corporation in the United States and/or other countries.



- Powered by JBlend™ Copyright 2002-2008 Aplix Corporation. All rights reserved. JBlend and JBlend-related trademarks are trademarks or registered trademarks of Aplix Corporation in Japan and other countries.
-  is a registered trademark of FeliCa Networks, Inc.
- microSDHC logo is a trademark.



- "Multitask" is a registered trademark of NEC Corporation.

- QR code is a registered trademark of Denso Wave Inc.
- 使いかたナビ® is a registered trademark of CANNAC, Inc.
- "One-push Open™" is a trademark of Matsushita Electric Industrial Co., Ltd.
- Java and Java related trademarks and logos are trademarks or registered trademarks of Sun Microsystems, Inc. in the United States and other countries.
- Powered by Mascot Capsule®/Micro3D Edition™ Mascot Capsule® is a trademark of HI CORPORATION.
- The image stabilization technology utilized is PhotoSolid®, a product of Morpho, Inc. PhotoSolid® is the registered trademark of Morpho, Inc. in Japan and other countries.
- Napster is a registered trademark of Napster, LLC. and/or its affiliates in the US and/or other countries.

- Other company names and product names described in the text are trademarks or registered trademarks of those companies.

## Others

- This product contains NetFront Browser and NetFront Sync Client of **NetFront ACCESS CO., LTD.** ACCESS and NetFront are trademarks or registered trademarks of ACCESS CO., LTD. in the United States, Japan and other countries. Copyright © 2008 ACCESS CO., LTD. All rights reserved.
- IrFront is a trademark or registered trademark of ACCESS CO., LTD. in Japan and other countries. The IrDA Feature Trademark is owned by the Infrared Data Association and used under license therefrom.
- Contains Adobe® Flash® Lite™ and Adobe Reader® LE technology by Adobe Systems Incorporated.  ADOBE FLASH ENABLED Adobe Flash Lite Copyright © 2003-2007 Adobe System Incorporated. All rights reserved. Adobe Reader LE Copyright © 1993-2007 Adobe Systems Incorporated. All rights reserved. Adobe, Adobe Reader, Flash, and Flash Lite are either registered trademarks or trademarks of Adobe Systems Incorporated in the United States and/or other countries.
- FeliCa is a contactless IC card technology developed by Sony Corporation.
- FeliCa is a registered trademark of Sony Corporation.



- Licensed by QUALCOMM Incorporated under one or more of the following United States Patents and/or their counterparts in other nations:
 

4,901,307	5,504,773	5,109,390	5,535,239	5,267,262	5,600,754
5,416,797	5,490,165	5,101,501	5,511,073	5,267,261	5,568,483
5,414,796	5,659,569	5,056,109	5,506,865	5,228,054	5,544,196
5,337,338	5,657,420	5,710,784	5,778,338		
- This product contains software licensed complying with GNU General Public License (GPL), GNU Lesser General Public License (LGPL), etc.  
For more details, see "readme.txt" in the "GPL・LGPL等について" folder on the bundled CD-ROM. ("readme.txt" is only available in Japanese version.)
- Advanced Wnn V2 of OMRON SOFTWARE Co., Ltd. is used for conversion methods for Japanese language.  
"Advanced Wnn V2" © OMRON SOFTWARE Co., LTD. 1999-2008 All Right Reserved.
- This product is licensed under the MPEG-4 patent portfolio license, AVC patent portfolio license and VC-1 patent portfolio license for the personal and non-commercial use of a consumer to
  - encode video in compliance with the MPEG-4 Visual Standard, AVC Standard and VC-1 Standard ("MPEG-4/AVC/VC-1 Video") and/or
  - decode MPEG-4/AVC/VC-1 Video that was encoded by a consumer engaged in a personal and non-commercial activity and/or was obtained from a licensed video provider licensed to provide MPEG-4/AVC/VC-1 Video.
 No license is granted or implied for any other use.  
Additional information may be obtained from MPEG LA, L.L.C.  
See <http://www.mpegla.com>.
- Copyright 2001 Seiko Epson Corporation.  
All Rights Reserved. PRINT Image Matching is a trademark of Seiko Epson Corporation.  
The PRINT Image Matching logo is a trademark of Seiko Epson Corporation.
- This product is manufactured or sold under license from InterDigital Technology Corporation.
- The abbreviations used for respective operating systems (Japanese version) in this manual are as shown below:  
Windows Vista is the abbreviation of Windows Vista® (Home Basic, Home Premium, Business, Enterprise, and Ultimate).  
Windows XP is the abbreviation of Microsoft® Windows® XP Professional operating system or Microsoft® Windows® XP Home Edition operating system.  
Windows 2000 is the abbreviation of Microsoft® Windows® 2000 Professional operating system.
- This product is protected by certain intellectual property rights of Microsoft Corporation and third parties. Use or distribution of such technology outside of this product is prohibited without a license from Microsoft or an authorized Microsoft subsidiary and third parties.

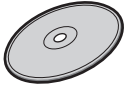
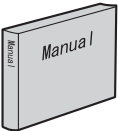

- This product is protected by certain intellectual property rights of Microsoft Corporation. Use or distribution of such technology outside of this product is prohibited without a license from Microsoft or an authorized Microsoft subsidiary.
- Content providers are using the digital rights management technology for Windows Media contained in this device ("WM-DRM") to protect the integrity of their content ("Secure Content") so that their intellectual property, including copyright, in such content is not misappropriated. This device uses WM-DRM Software to play Secure Content ("WM-DRM Software"). If the security of the WM-DRM Software in this device has been compromised, owners of Secure Content ("Secure Content Owners") may request that Microsoft revoke the WM-DRM Software's right to acquire new licenses to copy, display and/or play Secure Content. Revocation does not alter the WM-DRM Software's ability to play unprotected content. A list of Revoked WM-DRM Software is sent to your device whenever you download a license for Secure Content from the Internet or from a PC. Microsoft may, in conjunction with such license, also download revocation lists onto your device on behalf of Secure Content Owners.
- The copyrights on the designs described below are owned by TGB-design and NTT DOCOMO, INC.
  - Pre-installed files below:
    - Images that take the file name of "TGB-xxxx"
    - Melodies that take the file names of "RING-xxxx" and "SE-xxxx"
    - Images or i-motion movies on the Dialing/Call Receiving display, Videophone Dialing/ Videophone Call Receiving display, Mail Sending/Receiving display, Check New Message display, and Mail/Message Reception Result display
    - Power ON/OFF display
    - Wake-up display
    - Images during infrared data exchange
    - Processing display (while operating i-mode etc.)
    - Images displayed during dialing/during talk/during multi-connections/during answer-hold (On Hold)/during data communication
    - MUSIC Player Playback display (for when no image is stored on music)
    - Fonts below:
      - "Pattern 1" of "Disp. call/receive No.", the date and time, and the calendar
      - Coloring by "Color theme setting" (except "Black")
      - Icons for battery level, for radio wave level, during a voice call, during a video-phone call, and for Public Mode (Drive Mode)
      - Navigation icons
      - Notification icons
      - Paste icons (except the ones for Alarm and MUSIC Player)
      - Icons for the i-appli Stand-by display being set

## Accessories and Main Options

<Accessories>	
<ul style="list-style-type: none"><li>• <b>FOMA P706iμ Handset</b> (With Warranty and Back Cover P28)</li></ul> 	<ul style="list-style-type: none"><li>• <b>FOMA P706iμ CD-ROM</b> The PDF versions of "Manual for PC Connection" and "Kuten Code List" are included.</li></ul> 
<ul style="list-style-type: none"><li>• <b>Instruction Manual</b> Quick Manual included (See page 486)</li></ul> 	<ul style="list-style-type: none"><li>• <b>Battery Pack P17</b></li></ul> 

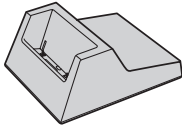
<Main Options>
<ul style="list-style-type: none"><li>• <b>FOMA AC Adapter 01/02</b> (With Warranty and Instruction Manual)</li></ul> 
<ul style="list-style-type: none"><li>• <b>Desktop Holder P26</b> (With Instruction Manual)</li></ul> 

Other Options → See page 452

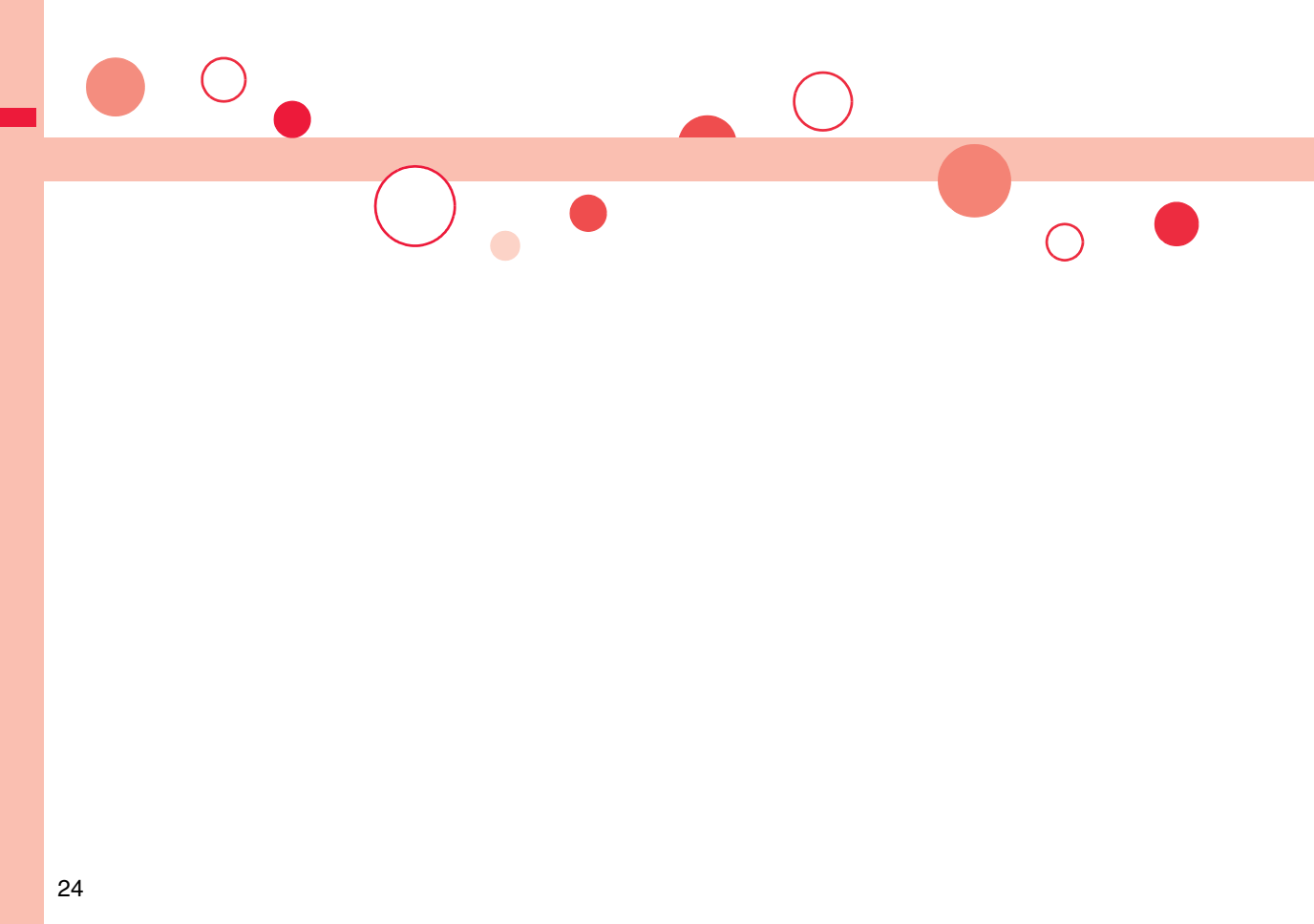

# Before Using the Handset

Phone Parts and Functions .....	26
Navigation Displays and Key Operations .....	28
Display .....	29
Displaying Description of Icons .....	<Icons> 31
Method for Selecting Menu .....	31
Using Simple Menu .....	35
When You do not Remember Key Operation .....	<Guide> 36
Using UIM (FOMA Card) .....	37
Attaching/Removing Batteries .....	39
Charging .....	40
Opening FOMA Phone by Using a Button .....	<One-push Open> 42
Checking Battery Level .....	<Battery Level> 42
Turning Power On/Off .....	<Power ON/OFF> 43
Switching to English .....	<Select Language> 43
Executing Initial Settings .....	<Initial Setting> 44
Setting Date and Time .....	<Set Time> 44
Displaying World Time .....	<World Time Watch> 45
Notifying the Other Party of Your Phone Number .....	<Caller ID Notification> 45
Checking Your Own Number .....	<Own Number> 46

# Phone Parts and Functions

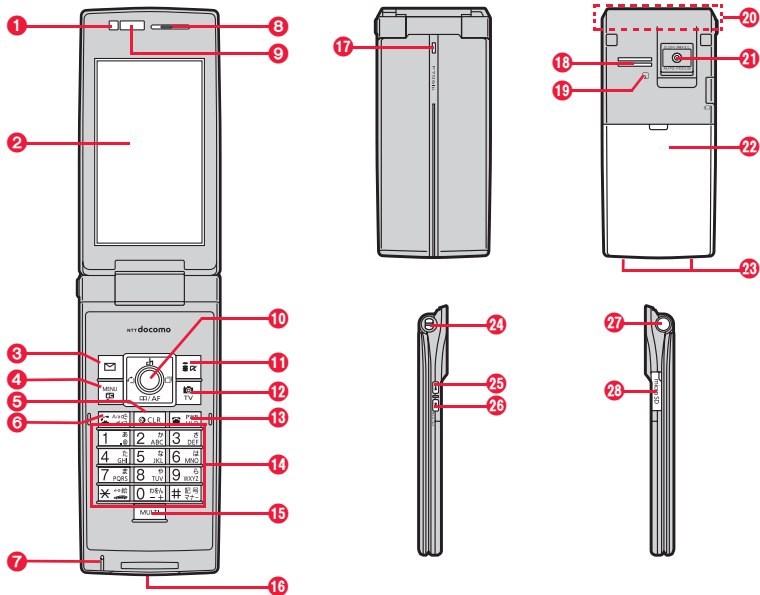

## 1 Light sensor

- For sensing brightness (See page 101)

- Do not cover the light sensor with your hands or do not put a sticker on it. Doing so might disable you to detect the brightness.

## 2 Display

- (See page 29)

## 3 Mail key

- For showing the Mail menu (See page 191)
- For operating the function corresponding to the navigation displays (See page 28)

**<Press and hold for at least one second>**

- For checking new messages (See page 187)

## 4 Menu key/IC Card Lock key

- For showing Main Menu (See page 31)

- For operating the function corresponding to the navigation displays (See page 28)

**<Press and hold for at least one second>**

- For locking the IC card (See page 246)

## 5 CLR Clear key

- For returning to the previous operation
- For clearing entered text or a phone number

**<Press and hold for at least one second>**

- For resetting Main Menu (See page 104)

## 6 Send/Answer key, Hands-free key

- For making/receiving calls (See page 48 and page 62)

- For talking with Hands-free (See page 61)

**<Press and hold for at least one second>**

- For accessing a voice dial entry (See page 89)

## 7 Microphone

- For speaking to the other party

### ■ For using the Flat-plug Earphone/Microphone with Switch (option)

Connect the Flat-plug Earphone/Microphone with Switch (option) to the Earphone Plug Adapter for External connector terminal (option).

1. Insert the flat plug for the Flat-plug Earphone/Microphone with Switch into the earphone terminal (flat-plug). (①)

2. Open the cover of the connector terminal for the FOMA phone. (See page 41)

3. Insert the plug for handset side into the connector of the FOMA phone. (②)

Take hold of the plug and insert or pull it straight into or out. Be careful not to take hold of the cover and plug together when you pull it out.

Flat plug for the Flat-plug Earphone/Microphone with Switch

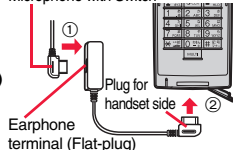



**8 Earpiece**

- For listening to the other party's voice

**9 Infrared data port**

- Used for infrared data exchange and the infrared remote-controller. (See page 317 and page 321)

**10 Command navigation key**

- For operating functions and menus (See page 28)

**11 i-mode key/i-appli key**

- For showing the i-mode menu (See page 150)
- For operating the function corresponding to the navigation displays (See page 28)

**<Press and hold for at least one second>**

- For showing the i-appli Software list (See page 221)

**12 Camera key/1Seg key**

- For activating the camera in "Photo mode" (See page 135)
- For switching the camera mode while the camera is activated (See page 129)
- For operating the function corresponding to the navigation displays (See page 28)

**<Press and hold for at least one second>**

- For starting 1Seg (See page 251)

**13 Power/End key**

- For ending calls    · For ending respective functions
- For turning on the power (for at least one second)/
- For turning off the power (for at least two seconds) (See page 43)

**14 Numeric keys**

- For entering phone numbers and text

-  (for at least one second)

For activating Manner Mode (See page 96)

-  (for at least one second)

For activating Public Mode (Drive Mode) (See page 66)

-  (for at least one second)

For switching the backlight on/off (See page 101)

-  (for at least one second)

For switching View Blind on/off (See page 102)

**15 Multi key**

- For showing the Multitask Menu (See page 354)

**<Press and hold for at least one second>**

- For switching functions when multiple functions are running (See page 354)

**16 Connector terminal**

- For connecting the AC adapter (option), DC adapter (option), FOMA USB Cable with Charge Function 01/02 (option), or Earphone Plug Adapter for External connector terminal 01 (option), etc.

**17 Call/Charging indicator**

- Flickers for incoming calls/mail and during a call. (See page 105)
- Lights in red during charging.
- Lights/Flickers when you shoot with the camera.

**18 Speakers**

- For sounding ring tones
- For listening to the other party's voice when Hands-free is activated (See page 61)

**19 FeliCa mark**

- The IC card is mounted.
- Use the IC card function placing this mark over the scanning device. You cannot dismount the IC card. (See page 239)

**20 FOMA antenna/1Seg antenna**

- The antenna is embedded in the FOMA phone. Do not cover the antenna with your hand for better communication/receiving.

**21 Camera**

- For shooting portraits and/or landscapes (See page 128)
- For catching sight of persons and/or landscapes during a videophone call

**22 Back cover**

- Remove this when attaching/removing the battery pack and UIM. (See page 37 and page 39)

**23 Charging terminal****24 Strap hole****25 Side ▲ key**

- For scrolling up page by page

**<Press and hold for at least one second with the FOMA phone opened>**

- For activating 2in1 (See page 396)

**26 Side ▼ key**

- For scrolling down page by page

- For using Record Message (See page 69)

- For checking for missed calls and new mail (See page 106)

**<Press and hold for at least one second with the FOMA phone closed>**

- For activating Manner Mode (See page 96)

**27 One-push open button**

- (See page 42)

**28 microSD card slot**

- For inserting microSD card (See page 305)

## Navigation Displays and Key Operations

When you want to execute the operation shown on the display, press the corresponding key as below.

### Basic display examples and key assignments

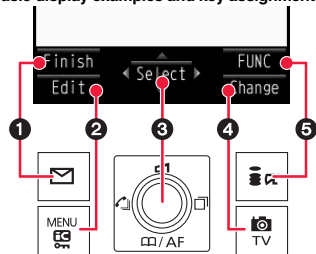

1	Indicates the operation you can perform with the  key.	
2	Indicates the operation you can perform with the  key.	
3	Indicates the operation you can perform with the  key.	
	Indicates the direction in which you can scroll and select items with the  key.	
4	Indicates the operation you can perform with the  key.	
5	Indicates the operation you can perform with the  key.	

### Operating command navigation key

#### Up

- Moves the cursor or highlighted display up. (Press and hold to scroll continuously.)
- Scrolls the display while a site or mail text is displayed.
- Press from the Stand-by display to bring up the Channel list. (See page 172)
- Converts entered characters to katakana, kanji or other characters. (See page 377)

#### Right/Redial

- Moves the cursor to the right.
- Press from the Stand-by display to bring up the Redial list. Press and hold for at least one second to bring up the Sent Address list. (See page 52 and page 200)
- Scrolls forward page by page. (Press and hold to scroll continuously.)
- Moves to the next page while displaying a site.

#### Left/Received Calls

- Moves the cursor to the left.
- Press from the Stand-by display to bring up the Received Call list. Press and hold for at least one second to bring up the Received Address list. (See page 53 and page 200)
- Scrolls back page by page. (Press and hold to scroll continuously.)
- Returns to the previous page while displaying a site.

#### Down

- Moves the cursor or highlighted display down. (Press and hold to scroll continuously.)
- Scrolls the display while a site or mail text is displayed.
- Press from the Stand-by display to bring up the Search Phonebook display. Press and hold for at least one second to store a Phonebook entry. (See page 78 and page 83)
- Converts entered characters to kanji, katakana or other characters. (See page 377)
- Adjusts the camera focus for shooting. (See page 139)

#### OK key

- Fixes the operation.

# Display

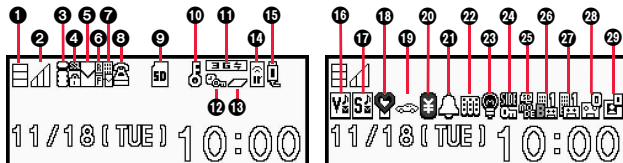

1		Battery level (estimate) (See page 42)
2		Radio waves reception level (estimate) Strong ← → Weak
		You are out of the FOMA service area or radio waves do not reach.
3		During Self Mode (See page 117)
		During i-mode (See page 150)
4		During i-mode communication (See page 150)
		During packet communication (The icon differs depending on the communication status.)
		You get out of the service area while Network Search Mode is set to "Manual". (See page 417)
5		During SSL communication (See page 150)
		Unread i-mode mail or an SMS message exists. (See page 185 and page 215)
6		The area for i-mode mail and SMS messages in the FOMA phone is full. (See page 186 and page 215)
		The area for SMS messages on the UIM (FOMA card) is full.
		Unread mail exists, and the area for SMS messages on the UIM (FOMA card) is full.
		Both the FOMA phone and UIM (FOMA card) are full.
7		Area Mail exists. (See page 208)
		Unread Messages R/F exist. (See page 206)
8		The area for Messages R/F in the FOMA phone is full. (See page 206)
		i-mode mail is held at the i-mode Center. (See page 187)
9		The box for i-mode mail at the i-mode Center is full. (See page 186)
		Messages R/F are held at the i-mode Center. (See page 206)
10		The box for Messages R/F at the i-mode Center is full. (See page 206)
		i-mode mail is held at the i-mode Center while Receive Option Setting is set to "ON". (See page 186)
11		During a voice call
		During a videophone call (64K)
		During a videophone call (32K)
12		During 64K data communication
		A microSD card is inserted. (See page 306)
13		Data is being read to/written from the microSD card.
		A write-protected microSD card is inserted. (See page 306)
14		The inserted microSD card cannot be used. (See page 306)
		A microSD card is inserted, and the FOMA USB Cable with Charge Function 01/02 (option) is connected in microSD Mode. (See page 313)
15		A microSD card is inserted, and the FOMA USB Cable with Charge Function 01/02 (option) is connected in MTP Mode. (See page 313)
		A microSD card is inserted, and the FOMA USB Cable with Charge Function 01/02 (option) is connected in MTP Mode. (See page 313)

16		Unread Messages R/F exist. (See page 206)
17		The area for Messages R/F in the FOMA phone is full. (See page 206)
		i-mode mail is held at the i-mode Center. (See page 187)
18		The box for i-mode mail at the i-mode Center is full. (See page 186)
		Messages R/F are held at the i-mode Center. (See page 206)
19		The box for Messages R/F at the i-mode Center is full. (See page 206)
		i-mode mail is held at the i-mode Center while Receive Option Setting is set to "ON". (See page 186)
20		During a voice call
		During a videophone call (64K)
		During a videophone call (32K)
21		During 64K data communication
		A microSD card is inserted. (See page 306)
22		Data is being read to/written from the microSD card.
		A write-protected microSD card is inserted. (See page 306)
23		The inserted microSD card cannot be used. (See page 306)
		A microSD card is inserted, and the FOMA USB Cable with Charge Function 01/02 (option) is connected in microSD Mode. (See page 313)
24		A microSD card is inserted, and the FOMA USB Cable with Charge Function 01/02 (option) is connected in MTP Mode. (See page 313)
		A microSD card is inserted, and the FOMA USB Cable with Charge Function 01/02 (option) is connected in MTP Mode. (See page 313)

25		A microSD card is inserted. (See page 306)
26		Data is being read to/written from the microSD card.
		A write-protected microSD card is inserted. (See page 306)
27		The inserted microSD card cannot be used. (See page 306)
		A microSD card is inserted, and the FOMA USB Cable with Charge Function 01/02 (option) is connected in microSD Mode. (See page 313)
28		A microSD card is inserted, and the FOMA USB Cable with Charge Function 01/02 (option) is connected in microSD Mode. (See page 313)
		A microSD card is inserted, and the FOMA USB Cable with Charge Function 01/02 (option) is connected in MTP Mode. (See page 313)

10		During Lock All (See page 116)
		During Personal Data Lock (See page 118)
		During Keypad Dial Lock (See page 119)
		During Secret Mode or Secret Data Only (See page 120)
		During IC Card Lock (See page 246)
		Both Keypad Dial Lock and Personal Data Lock are set.
		Both Keypad Dial Lock and Secret Mode/Secret Data Only are set.
		Both IC Card Lock and Lock All are set.
		Both IC Card Lock and Personal Data Lock are set.
		Both IC Card Lock and Keypad Dial Lock are set.
11		Both IC Card Lock and Secret Mode/Secret Data Only are set.
		IC Card Lock, Keypad Dial Lock, and Personal Data Lock are simultaneously set.
		IC Card Lock, Keypad Dial Lock, and Secret Mode/Secret Data Only are simultaneously set.
		Type of in-use network (See page 413)
12		You are in the OFFICEED area. (See page 402)
		Timer Lock ON At Close is set. (See page 119)
13		During Multitask (See page 353)
		Multiple functions are activated. (See page 353)
		While watching a 1Seg program (See page 251)
		During music playback (See page 341)
		During music pause (See page 341)

14		During infrared data exchange (See page 317 and page 321)
		The FOMA USB Cable with Charge Function 01/02 (option) is connected in Communication Mode.
15		The FOMA USB Cable with Charge Function 01/02 (option) is connected in microSD Mode. (See page 313)
		During talk or communication through a USB Hands-free compatible device (See page 61)
		A USB Hands-free compatible device is connected. (See page 61)
		A USB Hands-free compatible device is connected in microSD Mode. (See page 61)
		Vibrator is set. (See page 93)
16		Ring Volume is set to "Silent" or Mail/Msg. Ring Time is set to "OFF". (See page 65 and page 95)
		Ring Volume is set to "Silent" or Mail/Msg. Ring Time is set to "OFF". (See page 65 and page 95)
17		During Manner Mode (See page 96)
18		During Public Mode (Drive Mode) (See page 66)
19		The call cost has exceeded the specified limit. (See page 368)
20		An alarm is set. (See page 261 and page 357)
21		A Music&Video Channel program is booked. (See page 332)
22		Backlight is set to "OFF". (See page 101)
23		Side Keys Guard is set to "ON". (See page 120)
24		USB Mode Setting is set to "microSD mode". (See page 313)
		USB Mode Setting is set to "MTP mode". (See page 313)
25		Voice mail messages for Number B are held at the Voice Mail Center in Dual Mode of 2in1. (See page 401)
		Voice mail messages for Number B are held at the Voice Mail Center in Dual Mode of 2in1. (See page 401)

27		Voice mail messages are held at the Voice Mail Center. (See page 386)
28		The number of record messages (See page 68)
29		The number of videophone record messages (See page 68)

- For the icons of **5** through **7**, "white" icons change to "pink" or "yellow", and "black" icons change to "dark blue" when "Icon color" (see page 100) is set to "Color".
- The clock at the upper right of the display does not appear when the icon **14** or **15** is displayed.
- When the Stand-by display is shown, the notification icon or desktop icon appears. (See page 107)

### Information

- Some characters and symbols on the display might be modified or abbreviated.
- The color liquid crystal display uses high-precision production technology. The slightest change in the environment or other factors may result in unlit or permanently lit pixels, but this is not a manufacturing defect.

&lt;Icons&gt;

MENU 3 6

## Displaying Description of Icons

The symbols on the display (such as , , and ) are called icons. You can check the meanings of them on the display.

- 1  ► Settings ► Display ► Icons  
► Use  to highlight an icon.

## Method for Selecting Menu

Press  of the FOMA phone to bring up Main Menu so that you can execute, set, or check respective functions.

- Some functions can be selected also by the operation other than pressing . In this manual, the operation by the easier way is described.
- You can also switch to Simple Menu focusing on only basic functions for easy operation. (See page 35)
- This FOMA phone supports Kisekae Tool (see page 103). If you use Kisekae Tool to change the design of the Menu display, some menu configurations change according to the usage frequency depending on the type of the menu. Further, some menu numbers that are assigned to the menu items do not apply. In that case, you cannot operate as described in this manual, so you are advised to switch to the basic structure menu (see page 104), or reset menu settings (see page 104).

### ■ Scroll Selection

Main Menu is composed of 12 main menu icons indicating each function.

- If you select a main menu icon, the Sub-menu Item Selection display appears. If you further select a sub-menu item, the Lower Sub-menu Item Selection display appears.
- By repeating selecting, you can set and check the function.

### ■ Menu Number Selection

You can display some functions by pressing  + menu number (see page 422).

### ■ Multitask is Supported

- You can simultaneously use some functions in Main Menu. (See page 353)

## Scroll Selection

In this manual, the description of the command navigation key operation (selection of top/bottom/left/right, and press of  after selecting/entering a function item) is omitted. Scroll selection is explained below using the example of selecting the function “Quality alarm”:

### Description Example of Steps

Main menu icon    Sub-menu item    Function name of lower sub-menu item

1  ► Settings ► Talk ► Quality alarm ► Select an alarm.  
No tone . . . . . Does not sound.  
High tone . . . . . High alarm sounds.  
Low tone . . . . . Low alarm sounds.

Items which appear on the display



## STEP

1

Select a main menu icon from the menu function

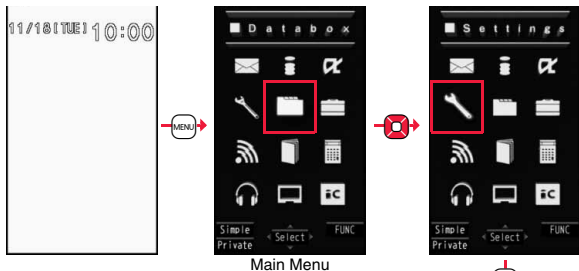
Select "Settings" from Main Menu. Main Menu at purchase differs depending on the body color. (See page 426)



- Press  to highlight the icon. Press and hold  to scroll the icons continuously.
- If you have not touched any key for 15 seconds, the Stand-by display returns.

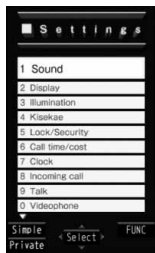





## STEP

2

Select a sub-menu item from the menu function

Select "Talk" from "Settings".



- The highlighted item is the currently selected one.
- Press  to highlight the item below, and  to highlight the item above.
- Press and hold  to scroll the items continuously.
- Press  to scroll page by page.

## STEP

### 3 Select a desired lower sub-menu item (function)

Select "Quality alarm" from "Talk".

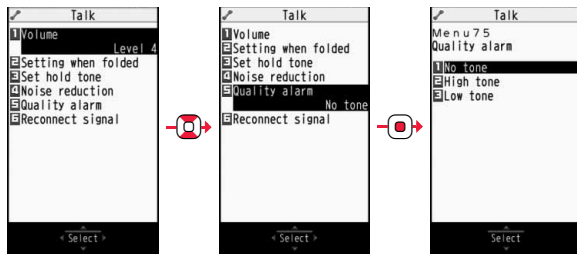

- Press to highlight the item below, and to highlight the item above.
- Press and hold to scroll the items continuously.
- When the items are listed over multiple pages, the total number of pages and the current page number are shown at the upper right of the display.

## STEP

### 4 Set or check the function

Some menu items have even more detailed menus.

The example below shows how to set "Low tone" for "Quality alarm".

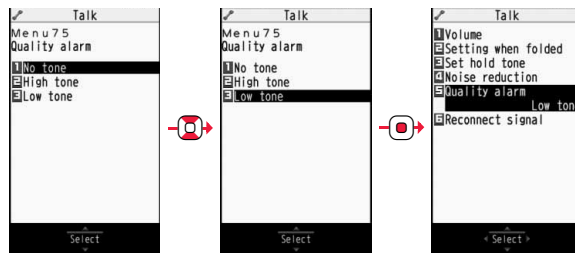

- The highlighted item is the currently selected one.
- Press to highlight the item below, and to highlight the item above.
- Press and hold to scroll the items continuously.

## Menu Number Selection

Menu Number Selection is explained below using the following example:

### Description Example of Menu Number



## STEP

# 1

Bring up the function using the menu number

From the Stand-by display, press **MENU** **7** **5**.



## Function Menu

If you press **FUNC** when “**FUNC**” is shown at the lower right of the display, the Function menu including selectable items such as “Save”, “Edit”, and “Delete” appears in each operation. The contents of the Function menu depend on the display from which you bring up the Function menu.

- When the items are listed over multiple pages, the total number of pages and the current page number are shown at the upper right of the Function Menu display.

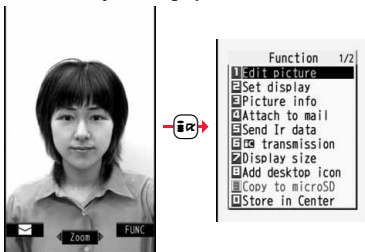

## Description Example for Function Menu

In this manual, the operation of the Function menu is described as follows:

Item displayed in the Function menu	Function menu	Operation/Explanation
Operating procedures after selecting an item in the Function menu	Delete all	You can delete all files. Enter your Terminal Security Code ▶ YES

An actual operation is done as follows:

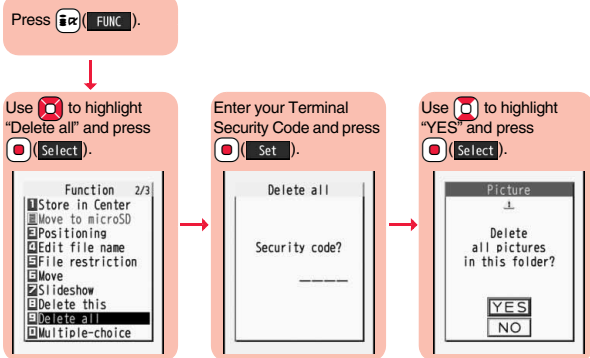

## To select an item quickly <Direct selection>

Press the numeric key corresponding to the displayed item number.

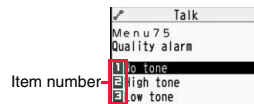



## Item scroll

When menu items are listed over multiple pages, you can show the previous/next page by pressing with the uppermost/lowermost item highlighted. You can press to scroll through page by page. When is displayed on the display, you can scroll through page by page also by pressing ().

- Depending on the display being shown, such as lower sub-menu items, you might be able to scroll through page by page also by pressing instead of .

## Check box

With the functions you can select multiple items, put a check mark for check boxes to select them. Each time you press (Select), you can switch "☐" and "☑".

With some functions, you can put or clear check marks at a time by pressing (FUNC) and selecting "Select all/Release all" or by pressing (SEL all/RLS all).

- "☑" is placed to the selected item depending on the function.

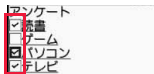

## After finishing the operation

The Lower Sub-menu Item Selection display is shown. When you press , the Stand-by display returns (except during Multitask). The Stand-by display or the former display automatically returns depending on the function.

## To cancel the operation midway

Press . The contents of the setting are abandoned and the Stand-by display or the former display returns. The confirmation display appears asking whether to abandon the setting contents depending on the function. You can press to return to the previous operation.

## When the "YES/NO" selection display appears

Press to highlight "YES" or "NO", then press (Select).

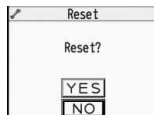

For Reset Settings

## Using Simple Menu

**Simple Menu is a menu focusing on only basic functions for easy operation.**

- This manual describes the operating procedures in Normal Main Menu only. For how to operate in Simple Menu, see the respective pages of each function.
- You cannot use the Multitask function. (See page 353)

## Switch to Simple Menu

You can switch between Normal Main Menu and Simple Menu.

From the Stand-by display, press .

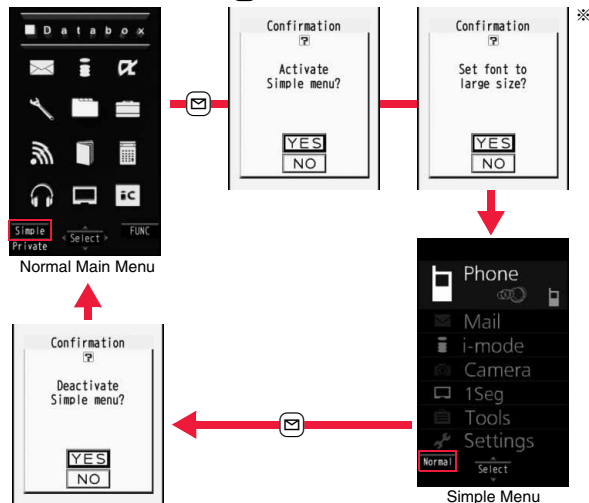

※ Select "YES" to set "Enlarge font display" on page 111 to "Large". Even when you release Simple Menu, the setting does not return. When "Large" has already been set, the confirmation display does not appear.

## Configuration of Simple Menu

Phone	Mail	i-mode	Camera
Phone Dialed calls Received calls Search phonebook Add to phonebook Record message Own number	Mail Received mail Sent mail Draft mail Compose message Message R/F Check new mail	i-mode Menu Bookmark Screen memo Last URL Enter URL	Camera Take photo View photos Record movie View movies
1Seg	Tools	Settings	
1Seg Activate 1Seg Timer recording Channel setting	Tools DataBOX Schedule Alarm Calculator Text memo Receive Ir data	Settings Ring tone/Volume Display/Font Call cost Set time Security Service	

&lt;Guide&gt;

## When You do not Remember Key Operation

You can search for the functions you want to know and use, and then check the operating methods. You can execute some functions from “使いかたナビ (Guide)”. This function is available in Japanese Mode only.

## 1 ステーションナリー (Stationery) 使いかたナビ (Guide) Select an item.

おすすめ機能 (Recommendable functions)

... Displays the recommendable functions. Go to step 3.

キーワード検索 (From keywords)





... Enter keywords and retrieve. Go to step 2

機能一覧検索 (From Function list)

... Retrieves from the function list. Go to step 3.

検索履歴 (Search history)

... Displays up to 30 search histories. Go to step 3.

- Highlight each item and press  (); then the detailed operating methods are displayed. If you highlight “キーワード検索 (From keywords)” and press  (), select “キーワード検索 (From keywords)” or “文字入力のかた (How to input words)”.

- The 使いかたナビ (Guide) display appears also by selecting the 使いかたナビ (Guide) icon “” pasted on the desktop at purchase.

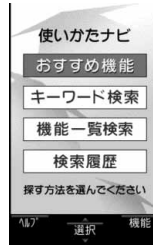

## 2 Enter a keyword.

Up to 50 search results are displayed.

- You can enter up to 24 full-pitch/48 half-pitch characters.

## 3 Select a function Select an item.







機能の説明 (Description) ... Displays explanations for the function.

操作のしかた (How to operate) ... Displays the operating method.

この機能を使う (Operate function)

... Executes the function. Operate each function.

関連機能 (Relevant function) ... Displays up to 10 relevant functions. Repeat step 3.

- For some functions, press  () several times for selection.
- You can display explanations about the function also by pressing  () while highlighting the function.
- To delete search history, press  () and select “1件削除 (Delete this)” or “全削除 (Delete all)”, then select “YES”.

## Using UIM (FOMA Card)

The UIM is an IC card that holds your information such as phone numbers. It can hold data such as Phonebook entries and SMS messages as well. By sharing a UIM, you can operate multiple FOMA phones for multiple purposes.

You cannot use the FOMA phone for communication such as voice and videophone calls, i-mode, sending/receiving mail, or packet communication unless the UIM is inserted.

For details on how to use the UIM, refer to the UIM instruction manual. When inserting or removing the UIM, take care not to accidentally touch or scratch the IC.

### Insert/Remove

You need to turn off the power and then remove the battery before you insert the UIM. (See page 39)

#### ■ Inserting

- 1 With the golden IC surface downward, push the UIM slowly to the end while pressing the surface of it.

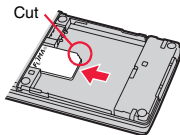

#### ■ Removing

- 1 While sliding the UIM, pull it out slowly.

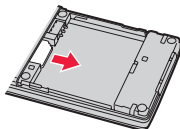

### Information

- Make sure that you insert/remove the UIM with the FOMA phone closed and held in your hand.
- Take care not to force the UIM into place because this can break it.
- Take care not to lose the UIM once you remove it.
- When you replace your UIM (except during Omakase Lock), you need to enter the four- to eight-digit Terminal Security Code after turning on the power. When you enter the correct Terminal Security Code, the Stand-by display appears. If you enter the incorrect Terminal Security Code five times in succession, the power turns off. (However, you can turn on the power again.)

### Password

You can set two passwords, PIN1 and PIN2, for a UIM. (See page 114)

### Security Function of UIM

The FOMA phone has the UIM security function (UIM restriction function) as a security function to protect your data files.

If you obtain data files by the method below with the UIM inserted, UIM security function is automatically set to them.

- When downloading images or melodies and so on, from sites or Internet web pages
- When receiving i-mode mail with file attachments

The data files with the UIM security can be browsed, played back, started, edited, attached to mail, or transferred via infrared rays only when the UIM used for obtaining is inserted. When the UIM used for obtaining the data or files is not inserted, or when another UIM is inserted, these functions are not operable.

- In the explanation hereafter, the UIM used to obtain data and files is referred to as "your UIM" and other UIMs as "another person's UIM".

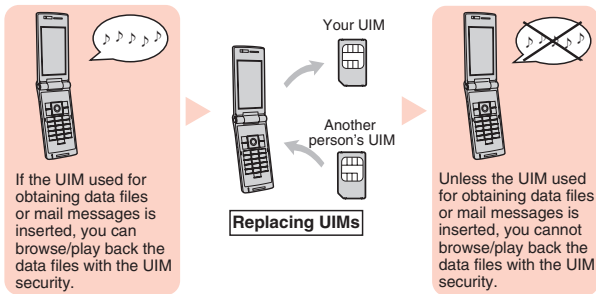

- When the UIM is not inserted or when another person's UIM is inserted, the following types of data and files are displayed with the restrictions symbol, "🔒":

- Videophone record messages
- Movie memos
- Screen memos
- Templates
- i-appli programs
- Images
- i-motion movies
- Chara-den images
- Melodies
- Kisekae Tool files
- PDF files

- Chaku-uta®/Chaku-uta Full® music files
- Downloaded dictionaries
- Files attached or pasted to i-mode mail in the Inbox
- Files attached to i-mode mail in the Outbox/Draft (except the data shot or edited with the FOMA phone)
- Messages R/F with files (melodies or images) attached or pasted
- Images inserted into Deco-mail text

- This function applies to the pre-installed i-appli programs, Chara-den images, Deco-mail pictograms, etc. if they are reinstalled (upgraded) from a site.
- \*"Chaku-uta" is a registered trademark of Sony Music Entertainment Inc.

- The preview image for the data file with the UIM security appears as shown on the right.



## Information

- When the UIM security is set for data files, you cannot set them for the functions such as "Display setting" and "Select ring tone" when another person's UIM is inserted.
- When the data files with the UIM security is set for "Display setting" or "Select ring tone", the FOMA phone works with their default settings if you replace your UIM with another person's UIM. If you insert your UIM again, your settings are enabled again.
- The UIM security function is not set for the data files received using the infrared data exchange function or data transmission (OBEX™ communication) function and the still images/moving images shot or edited with the FOMA phone.
- Even when another person's UIM is inserted, you can move/delete data files with the UIM security.
- The settings of the following functions are stored on the UIM:
  - SMS validity period
  - SMS center selection
  - Select language
  - PLMN setting
  - PIN1 code, PIN2 code
  - PIN1 code entry set
  - Validating/Invalidating DOCOMO Certificate 1 and user certificate

## Types of UIM (FOMA Card)

If you use the blue UIM with your FOMA phone, note that following specifications differ from those of the green/white UIM:

Functions	UIM		Reference
	(blue)	(green/white)	
Number of digits of the phone number that can be stored in the UIM Phonebook	20 max.	26 max.	79
Operation of user certificate to use FirstPass	Cannot be used	Can be used	167
Use of WORLD WING	Cannot be used	Can be used	412
Use of Service Numbers for "DOCOMO repair counter" and "General inquiries <DOCOMO Information Center>"	Cannot be used	Can be used	393

**■ WORLD WING**

WORLD WING is the DOCOMO FOMA international roaming service that enables you to use the current phone number overseas for making and receiving calls using the UIM (green/white) and service compatible mobile phone.

You can use P706ij only in the DOCOMO 3G roaming service area. For using in a GSM service area, insert the UIM into a GSM service compatible mobile phone.

- You do not need to subscribe to WORLD WING if you have subscribed to the FOMA service after September 1, 2005. If you offered that you did not need WORLD WING at the time you signed up for the FOMA service, or when you have midway canceled WORLD WING, you are required to take the procedures to newly subscribe to WORLD WING.

- If you have signed up for the FOMA service before August 31, 2005, and have not yet subscribed to WORLD WING, you are required to subscribe to it.

- This service is not available with some billing plans.

- If you lose your UIM (green/white) or have it stolen overseas, immediately contact DOCOMO to take the steps necessary for suspending the use of the UIM. For inquiries, see "DOCOMO Information Center" on the back page of this manual. Note that you are still charged the call and communication fees incurred after you lose it or have it stolen.

## Attaching/Removing Batteries

Use the FOMA phone's dedicated Battery Pack P17.

**■ Attaching**

- 1 While pressing the surrounding part of "○", slide the back cover (2 mm or more) in the direction of the arrow to unlock and remove it.

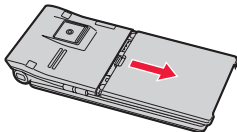

- 2 As illustrated, securely match the battery pack to the dent on the FOMA phone with the arrow-marked surface upward, and depress the battery pack in the direction B while pushing it in the direction A.

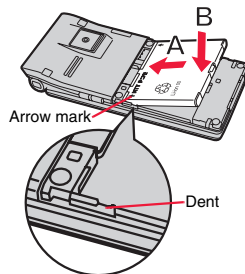

- 3 Slide the back cover in the direction of the arrow and attach it in place.

- Make sure that there is no gap between the back cover and the FOMA phone, and then slide the back cover and close it completely. If it is not completely closed, you may hurt your hand or fingers because it is made of metal.

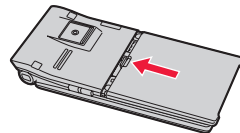
**■ Removing**

- 1 While pressing the surrounding part of "○", slide the back cover (2 mm or more) in the direction of the arrow to unlock and remove it.
- 2 Take hold of the projection of the battery pack to lift it up.

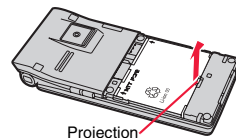
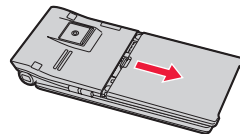

**Information**

- Make sure that you attach/remove the battery with the FOMA phone closed and held in your hand after you turn off the power. Also, make sure not to press the one-push open button when you attach/remove the battery.
- If you try to force the battery into place, you could damage the UIM or the charging terminal of the FOMA phone.

**Charging****Use the FOMA phone's dedicated Battery Pack P17.****Life of battery pack**

- Battery packs are consumables. The usable time shortens slightly each time they are charged.
- When the usable time of the battery pack becomes half the time it was purchased, replacing is recommended because the battery pack is nearing the end of its life. Depending on the use conditions, the battery pack may swell as it nears the end of its life, but this is not a problem.
- The life of the battery pack may shorten if you use i-oppli programs, talk on the videophone, watch 1Seg programs and so on for a long time during charging.

**For environmental protection, bring the unneeded battery pack to an NTT DOCOMO shop, dealer, or recycle shop.**

**Charging**

- For details, refer to the instruction manuals for the FOMA AC Adapter 01/02 (option), FOMA AC Adapter 01 for Global use (option), and FOMA DC Adapter 01/02 (option).
- The FOMA AC Adapter 01 supports 100 V AC only. The FOMA AC Adapter 02 and FOMA AC Adapter 01 for Global use support from 100 V AC through 240 V AC.
- The shape of the plug for the AC adapter is for 100 V AC (for domestic use). To use the AC adapter that supports from 100 V AC through 240 V AC overseas, you need to have a conversion plug adapter that is compatible with the voltage of the country you stay. Do not use a transformer for overseas travel to charge the battery pack.
- Even during charging, you can still answer calls if the FOMA phone is turned on. This will consume the charged amount so that charging will take longer. Also, the standby time or talk time might be shorter if you charge the battery pack with your FOMA phone open.
- If you have a long time videophone call during charging, the temperature in the FOMA phone may rise and charging may be suspended. In such a case, wait for a while and try charging again.

- Remove and insert the connector slowly and carefully, without using unnecessary force.
- Do not remove the battery pack during charging.

**Do not charge for long periods of time (several days) with the FOMA phone turned on.**

- If you leave the FOMA phone powered on for long periods of time during charging, you may not be able to use the FOMA phone for long duration as expected and the low battery alarm may sound soon, because the FOMA phone receives the power from the battery pack after charging is completed. If this happens, charge the battery pack correctly. When charging the battery pack again, first remove the FOMA phone from the AC adapter (or desktop holder) or DC adapter and then set it again.

**Estimated usable time for battery pack** (The usable time for the battery pack varies with the charging time and the remaining life of the battery pack.)

<b>Continuous standby time (FOMA/3G)</b>	<b>Standstill: Approx. 440 hours</b> <b>In motion: Approx. 310 hours</b>
<b>Continuous talk time (FOMA/3G)</b>	<b>Voice call: Approx. 150 minutes</b> <b>Videophone call: Approx. 100 minutes</b>
<b>1Seg watching time</b>	<b>Approx. 210 minutes</b> <b>(In ECO Mode: Approx. 260 minutes)</b>

- ※ The continuous talk time is the estimated time that the FOMA phone can be used for calls when radio waves can be sent and received normally.
- ※ The continuous standby time is the estimated time when radio waves can be received normally. The standby time could be about half of this estimate depending on the charge level of the battery pack, function settings, other ambient conditions such as temperature, and the status of radio waves in the area (weak or no radio waves, for instance). When you use i-mode communication, the talk/communication time and standby time will be shorter. Further, even if you do not make calls or not execute i-mode communication, the talk/communication time and standby time will be shorter if you watch 1Seg programs, compose i-mode mail, start up a downloaded i-oppli program or the i-oppli Stand-by display, execute data communication or Multiaccess, use the camera, or play back music.
- ※ The continuous talk time and the continuous standby time may be shortened depending on the network environment in the country you stay.
- ※ The continuous standby time for standstill is the average number of hours you can use the FOMA phone in standstill status when it is closed and can receive radio waves normally.
- ※ The continuous standby time for in motion is the average number of hours you can use the FOMA phone in the combined status of "standstill" "moving" and "out of the service area" when it is closed, in an area where it can receive radio waves normally.
- ※ The 1Seg watching time is the estimated time for when radio waves can be received normally with the Flat-plug Stereo Earphone Set P01 (option) connected. The watching time might be shortened depending on the charge level of the battery pack, function settings, other ambient conditions such as temperature, and the status of radio waves in the area (weak or no radio waves, for instance).

## Estimated time for charging battery pack

AC adapter	Approx. 100 minutes	DC adapter	Approx. 100 minutes
------------	---------------------	------------	---------------------

※ The charging time is an estimate of time for when empty battery pack is charged with the FOMA phone turned off. The charging time will be longer if you charge the battery pack with the power of the FOMA phone turned on.

## Charge with AC Adapter and Desktop Holder

### 1 Connect the AC adapter (option) to the desktop holder (option).

### 2 Insert the AC adapter's plug into a power socket.

### 3 Set the FOMA phone onto the desktop holder securely.

Check that the Call/Charging indicator lights in red.

When the Call/Charging indicator flickers, dismount the AC adapter and battery pack from the FOMA phone and then re-mount them for charging. If the symptom persists, troubles with the AC adapter, desktop holder or battery pack may be involved, so consult a handling counter such as a DOCOMO shop.

- Be sure to set the FOMA phone onto the desktop holder with the FOMA phone closed.
- The charging confirmation tone (see page 95) sounds when charging starts and ends. However, it does not sound when the power is off or during Manner Mode or Public Mode (Drive Mode).
- Be sure to set the FOMA phone firmly onto the desktop holder. Also, be careful that the connector cover or a commercial strap is not caught between the FOMA phone and desktop holder.

### 4 When charging is completed, hold the desktop holder with fingers and lift up the head of FOMA phone to remove.

- Unplug the AC adapter from the power socket when you are not going to use it for a long time.

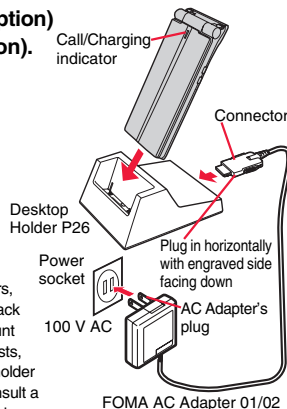

## Indicator and display during charging and when charging is completed

	Call/Charging indicator	"  " display
Charging	Lights in red	Blinks
Charging completed	Off	Lights

- When the FOMA phone is turned off, "" does not appear. If you start charging with the battery flat, the Call/Charging indicator might not light immediately; however, charging itself has started.

## When charging only with the AC adapter

Insert the connector with the engraved surface facing up until it clicks. Pull straight the connector out while pressing the release buttons.

- To charge the battery, place the cover of the connector terminal as illustrated. Pull out the cover of the connector terminal to the left (▷ mark side) (①), and turn it as illustrated (②).

※ Check the facing direction (front or rear) of the AC adapter plug and then insert or pull it horizontally into or out of the FOMA phone. Malfunction could result if you try to pull it forcibly.

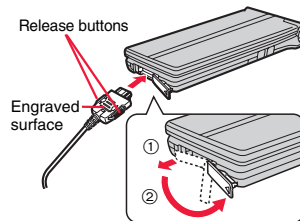

## DC adapter (option)

With the DC adapter, you can use a cigarette lighter socket (12 V/24 V) of cars to charge the FOMA phone with the battery pack attached.

For details, refer to the instruction manual for the FOMA DC Adapter 01/02.

## Information

- If the fuse blows off when charging with the DC adapter, be sure to use a 2A fuse. The 2A fuse is consumables, so purchase at auto parts stores in your neighborhood.

## &lt;One-push Open&gt;

## Opening FOMA Phone by Using a Button

You can open the FOMA phone easily by one-push key operation. (One-push Open)

- You can open it also manually without using the button.
- You need to close the FOMA phone manually. If it does not close, open it fully and then close it.

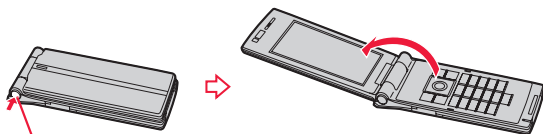

One-push open button

## Information

- When you open the FOMA phone by pressing the one-push open button, it might not open fully depending on its direction.
- When you open the FOMA phone by pressing the one-push open button, be careful not to drop it by its rebound.

## &lt;Battery Level&gt;

## Checking Battery Level

When the FOMA phone is turned on, an estimate of the battery level is indicated by the icon.

- Almost full .....
- Getting low .....
- Almost empty .....
- Charge the battery when it is almost empty.

## Check by Display and Tone

You can check an estimate of the battery level by the display and sound.

1 Settings > Other settings > Battery > Battery level

Almost full  
Three beeps



Getting low  
Two beeps

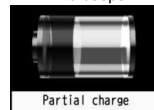

Almost empty  
One beep

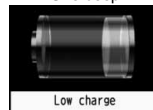

※ Almost empty.  
Charge the battery.

- The pictograph disappears in about three seconds.

## When the battery is running out

The display on the right appears and the low battery alarm sounds for about 10 seconds. To stop this alarm, press any key other than and . About one minute later, the FOMA phone will be turned off.

- During a call, a beeping tone from the earpiece notifies you of the low battery. About 20 seconds later your call will be cut and then one minute later the FOMA phone will be turned off.



Recharge battery  
Recharge Battery  
display



<Power ON/OFF>

## Turning Power On/Off

### Turn Power On

#### 1 Press and hold for at least one second.

After the Wake-up display (see page 99) is displayed, the Stand-by display appears.

- If you have stored many Phonebook entries or mail messages, it may take a while for the display to appear.
- If Set Time is set, the current date and time are shown.
- When "☎" is displayed, the FOMA phone is out of the service area or in the place where the radio waves do not reach. Move to a location where "☎" disappears.
- If "starting system wait a minute" is displayed when you turn on the power, wait for a while and then proceed.



Stand-by display



#### When your UIM is replaced (except during Omakase Lock)

Enter the four- to eight-digit Terminal Security Code after turning on the power. When you enter the correct Terminal Security Code, the Stand-by display appears. If you enter the incorrect Terminal Security Code five times in succession, the power turns off. (However, you can turn on the power again.)

#### When "PIN1 code entry set" of "UIM setting" is set to "ON"

Enter the four- to eight-digit PIN1 code after you turn on the power. When you enter the correct PIN1 code, the Stand-by display appears. See page 114 for PIN1 code.

#### When "Auto reset setting" of "Notice call cost" is set to "ON" (except during Omakase Lock)

Enter the four- to eight-digit PIN2 code after you turn on the power. When you enter the correct PIN2 code, the Stand-by display appears. If you press  or  without entering the correct PIN2 code, "Auto reset setting" is set to "OFF" and the Stand-by display appears. See page 114 for PIN2 code.

### Information

- Each entry display appears in the order of "PIN1 code" → "Terminal Security Code" → "PIN2 code".

### Turn Power Off

#### 1 Press and hold for at least two seconds.

The exit display appears and the power turns off.

- You cannot turn on the power immediately after turning off the power. Wait a few seconds.

<Select Language>

MENU 1 5

## Switching to English

#### 1 **設定 (Settings)** ▶ **ディスプレイ (Display)** ▶ **バイリンガル (Select language)** ▶ **Japanese (日本語) or English (英語)**

- The following functions are different between Japanese display and English display:

Functions	Japanese	English
Info Notice Setting	電子音 (Electrical tone) ボイス (Voice) OFF	ON Not available OFF
"Clock" of Display Setting → "Day of week"	Available	Not available
使いかたナビ (Guide)	Available	Not available
Voice Guidance	Available	Not available

### Information

- When you insert the UIM, the "バイリンガル (Select language)" setting is stored on the UIM.

## &lt;Initial Setting&gt;

## Executing Initial Settings

If the date and time, Terminal Security Code, Keypad Sound, or Character Size is not set, the Initial Setting display appears when you turn on the power. You can set the initial settings also from each menu function separately.

## 1 Turn on the power ▶ YES

- When the display for entering your Terminal Security Code, PIN1 code, or PIN2 code appears, follow the operation on page 43.



## 2 Set the date and time.

You can select "Auto time adjust ON" or "Auto time adjust OFF" for setting the time. (See page 44)

## 3 Set your Terminal Security Code.

You can set your Terminal Security Code required for setting functions. (See page 114)

- Enter "0000" ▶ Enter your new Terminal Security Code (four to eight digits) ▶ YES

## 4 Set Keypad Sound.

You can set whether to make a keypad sound. (See page 94)

## 5 Set the size of characters.

You can set the size of characters on the display at a time. (See page 111)

## Information

- When an unset function is found, the Initial Setting display for the unset function appears each time you turn on the power.
- The completed settings are valid even when total setting is interrupted by an incoming call or canceled by pressing or midway.
- When the power is automatically turned on by alarm notification, the Initial Setting display does not appear even if there is any unset function.

## Information

- When you finish the initial settings, the confirmation display appears telling that updating software is executed automatically. This display appears only at the first time, and after that, does not appear until you execute Reset Settings or Initialize.

## &lt;Set Time&gt;

MENU 3 1

## Setting Date and Time

You can select whether to correct the time automatically or set it manually. The time is set/displayed on the 24-hour basis.

## 1 ▶ Settings ▶ Clock ▶ Set time

## ▶ Auto time adjust ON or Auto time adjust OFF

## Auto time adjust ON

... Corrects the date/time automatically. The setting is completed.

When the time cannot be corrected automatically such as when is displayed and the date/time has not been set, the Manual Time Setting display appears. Follow step 2 to set the date/time.

## Auto time adjust OFF

... Sets the date/time manually.

- When "Notice call cost" is set to "ON", you need to enter your Terminal Security Code.

## 2 Enter year, month, date and time.

Use to move the cursor and enter numbers by the numeric keys.

- To enter one-digit numeral for the date and time, enter two digits beginning with "0" as in "01" through "09".
- Highlight "time zone" and press to set the time zone. Use to select a region and press .



## About date/time correction function

The time displayed on the FOMA phone is corrected according to the clock information obtained from the network.

The time is corrected when you show the Stand-by display with "Auto time adjust ON" set. If you want to set the time with a lag, set the time manually.

- Some few second errors might occur. You might not be able to correct the time depending on the radio wave conditions, or the i-appli program set for the i-appli Stand-by display.
- When you receive the clock information overseas and the time difference correction information differs from the previously received one, "Time is adjusted" is displayed and the time difference is corrected automatically. Press "OK" to update the time and show Redial, Dialed Calls, Received Calls, sent/received mail messages and others in local time.
- Depending on the networks overseas, the time difference might not be corrected.

### Information

- Unless Set Time is set, the functions which use the clock such as Schedule do not work correctly. Further, the date/time for redial items and received call records are not stored.
- The set time is retained even when the battery pack is replaced, however, it might be reset if the battery pack is left removed for a long time. In that case, charge the FOMA phone and then perform the clock setting.
- When "time zone" is set to other than "GMT +9" or the time difference is corrected overseas, the sub clock (Japanese date/time, etc.) is displayed under the Stand-by display clock.
- This function supports clock settings from 00:00 on January 1, 2007 through 23:59 on December 31, 2037.

## <World Time Watch>

### Displaying World Time

You can display the time of the specified area under the Stand-by display clock.

- 1  **Settings** ▶ **Clock** ▶ **World time watch** ▶ **ON or OFF**  
▶ Use  to select an area and press  (**Select**).

### Information

- World Time Watch does not appear when "Display setting" → "Clock" → "Clock display" is set to "OFF", or when you use the FOMA phone overseas.

## Summer Time

You can advance the time displayed for the overseas country you stay and for a region of World Time Watch by one hour.

- 1  **Settings** ▶ **Clock** ▶ **Summer time** ▶ **ON or OFF**

## <Caller ID Notification>

### Notifying the Other Party of Your Phone Number

You can set the FOMA phone to send your phone number to the called party's phone when dialing. Your phone number is important information, so take utmost care when notifying your phone number. This function is available only when the other party's phone supports Caller ID.

### Set Caller ID Notification to Network

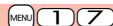

You can set whether to notify your caller ID on the network.

- 1  **Service** ▶ **Caller ID notification**  
▶ Do the following operations.

Item	Operation/Explanation
Activate	▶ ON or OFF
Check setting	You can check the setting contents of "Activate".

&lt;Own Number&gt;



## Checking Your Own Number

- Your phone number (own number) is stored on the UIM.

### 1 MENU ► Phonebook ► Own number

You can press to switch the tabs.

- See page 365 for storing/displaying personal data.

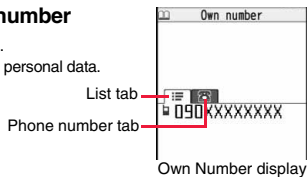

### Information

- In Dual Mode of 2in1, you can switch between Number A and Number B by pressing from the Own Number display. "" appears for Number A, and "" appears for Number B.
- When you replace a UIM with another one (2in1 contractor → 2in1 contractor) while using 2in1, perform "2in1 function OFF" (see page 397) and then set "2in1 setting" to "YES", or perform "Auto acquire No. B" (see page 366), to acquire the correct Number B.  
When you replace a UIM with another one (2in1 contractor → 2in1 non-contractor), perform "2in1 function OFF" as well to update the owner's information to the correct one.

# Voice/Videophone Calls

## Making Calls/Videophone Calls

About Videophone .....	48
Making a Call/Videophone Call .....	48
Switching between a Voice Call and a Videophone Call .....	51
Using Call Records . . . . . <Redial> <Dialed Calls> <Received Calls>	52
Using Chaku-moji .....	<Chaku-moji> 54
Notifying/Not notifying Your Phone Number by Call. . . . . <186/184>	56
Sending Touch-tone Signals .....	<Pause Dial> 57
International Calls .....	<WORLD CALL> 58
Setting for International Calls .....	<International Dial Assist> 59
Storing Numbers to be Added to the Beginning of a Phone Number .....	<Prefix Setting> 60
Making a Call with Specified Sub-address .....	<Sub-address Setting> 60
Setting Alarm for Reconnecting .....	<Reconnect Signal> 60
Reducing Surrounding Noise to Make Voice Clear .....	<Noise Reduction> 61
Switching to Hands-free .....	<Hands-free> 61
Using Hands-free Compatible Devices .....	<In-Car Hands-free> 61

## Receiving Calls/Videophone Calls

Receiving a Call/Videophone Call .....	62
Switched between a Voice Call and a Videophone Call by the Other Party .....	63
Setting Response of Key Operation for Answering Incoming Calls .....	<Answer Setting> 63
Setting Response for when Opening FOMA Phone during Ringing .....	<Setting when Opened> 64
Setting Response for when Closing FOMA Phone during a Call .....	<Setting when Folded> 64
Adjusting Earpiece Volume .....	<Volume> 64
Adjusting Ring Volume .....	<Ring Volume> 65

## When You Cannot or Could not Answer the Call

Putting an Incoming Call on Hold when You cannot Answer at Once .....	<On Hold> 65
Putting a Call on Hold during a Call .....	<Holding> 65
Setting Hold Tone .....	<Set Hold Tone> 66
Using Public Mode (Drive Mode) . . . . . <Public Mode (Drive Mode)>	66
Using Public Mode (Power Off) .....	<Public Mode (Power Off)> 67
If You could not Answer an Incoming Call .....	<Missed Calls> 68
Recording Voice/Video Messages when You cannot Answer the Call .....	<Record Message Setting> 68
Recording Voice/Video Messages when You cannot Answer the Call during Ringing. . . . .	<Quick Record Message> 69
Playing Back/Erasing Record Messages/a Voice Memo/Videophone Record Messages/Movie Memos .....	<Play/Erase Messages> <Play/Erase Videophone Messages> 70

## Making Full Use of Videophone Calls

Using Chara-den .....	71
Useful Functions for Videophone Calls .....	72
Setting Videophone Hands-free . . . . . <Hands-free with Videophone>	74
Setting Image Quality for Videophone Calls . . . . . <Visual Preference>	74
Changing Image Displays for Videophone Calls . . . . . <Select Image>	74
Redialing as a Voice Call when a Videophone Call cannot be Connected .....	<Voice Call Auto Redial> 75
Setting for Switching between a Voice Call and a Videophone Call .....	<Notify Switchable Mode> 75
Selecting Response to Incoming Videophone Calls during i-mode .....	<Videophone while Packet> 75
Connecting FOMA Phone to External Devices to Use Videophone Function .....	76

## About Videophone

You can talk while viewing sent/received images. By default, the substitute image is sent to the other party.

This FOMA phone has no inward-facing camera. Therefore, the image sent to the other party is a Chara-den image, still image, or image being shot by the outward-facing camera.

DOCOMO videophones conform to 3G-324M, standardized by the international standard 3GPP. You cannot connect to the videophone that uses a different format.

### ●3GPP (3rd Generation Partnership Project):

This is the regional standards organization for developing common technical specifications for third-generation mobile telecommunication systems (IMT-2000).

### ●3G-324M:

This is the international standard for the third generation of mobile videophones.

### ●P706μ supports only 64 kbps communication speed of videophone dialing.

You can talk but cannot make a videophone call at 32 kbps communication speed.

### ■Display during videophone calls

- Received image (The other party's image through the camera or substitute image)
- Sent image (Substitute image or image through your camera)
- Call duration
- Status

: 64K communicating

: 32K communicating

: Voice sending/receiving

(gray): Voice sending/receiving failed\*1

: Image sending/receiving

(gray): Image sending/receiving failed\*2

: Camera image sending

: Still image sending

: Chara-den talking

: Hands-free activated

: Landscape

: Close-up

: Night Mode

: Chara-den Whole Action Mode

: Chara-den Parts Action Mode

: DTMF Transmission Mode

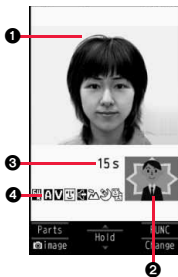

※1 When voice sending fails, the other party cannot hear your voice.

When voice receiving fails, you cannot hear the other party's voice.

※2 When image sending fails, the sent image is not displayed at the other end.

When image receiving fails, the received image is not displayed.

When voice or image sending/receiving fails, it does not recover automatically. You need to make a videophone call again.

## Making a Call/Videophone Call

### 1 Enter the other party's phone number, starting with the city code.

- When 27 or more digits are entered, the lower 26 digits only are displayed.
- To store an entered phone number in the Phonebook, press (**Store**). Go to step 2 on page 82.
- Even when you are dialing within the same area, you need to enter the city code before the phone number.

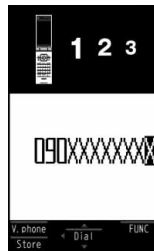

### 2 When Making a Voice Call



Press or (**Dial**).

- "" blinks during dialing, and lights during a call.



## When Making a Videophone Call

Press  (V. phone).

- “H” blinks during dialing and lights during the call.
- During a videophone call, you can press  (Image) to display the image through your camera at the other party. To resume the substitute image, press  (Subst.) again.

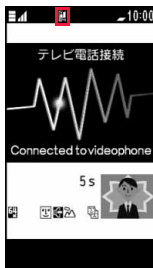

The digital communication charging starts from this display.



**3** Press  to end the call after talking.

### Information

- If you hear the guidance requesting your caller ID (see page 392), follow the steps of “To notify your caller ID” on page 56 to enter “186” and redial.
- When the Flat-plug Earphone/Microphone with Switch (option) is connected, you can hear the other party’s voice from the earphone. (See page 371)
- If you close the FOMA phone during a call, the FOMA phone works in accordance with the setting of “Setting when folded”. (See page 64)
- You can press numeric keys to send touch-tone signals during a call. During a Chara-den call, you need to switch to DTMF Transmission Mode. (See page 73)
- In Dual Mode of 2in1, you can make a call after selecting Number A or Number B. (See page 398)

### Information

#### <For Voice Calls>

- You can make a voice call also by pressing  and then entering the party’s phone number. If you enter a wrong number, press  to clear the display and then redial.

#### <For Videophone Calls>



- Just after purchase, Hands-free is automatically activated by “Hands-free w/ V. phone” (see page 74). However, Hands-free is deactivated during Manner Mode regardless of “Hands-free w/ V. phone”.
- When you make a videophone call with substitute image, note that you will still be charged for the digital communication, not the voice calls.
- If you make a videophone call at 110/119/118 from the FOMA phone, it is automatically dialed out as a voice call.
- The international videophone call is available using the DOCOMO international call service “WORLD CALL”. (See page 58)



### Display during dialing

The other party’s name and icon are displayed if the party’s phone number and name are stored in the Phonebook. However, the image is not displayed even if it is stored in the Phonebook.

- If the same phone number is stored with multiple names in the Phonebook, the name that comes first in the search order (see page 84) is displayed.
- The phone number instead of the name is displayed when you make a call during Personal Data Lock or to the party stored as secret data in the Phonebook.

### If you entered a wrong phone number

Each time you press , the digit on the far right is cleared. If you press and hold  for at least one second, all the digits are cleared and the Stand-by display returns.

- Press  to move the cursor to the digit you want to clear, and then press  to clear it. To clear all the digits on and to the right of the cursor, press and hold  for at least one second.

### If a videophone call could not be connected

The reason why it could not be connected is displayed. (The displayed reason might not be the same as the actual reason depending on the type of the other party's phone and contract for network services.)

Messages	Reasons
Check number, then redial	You have dialed a non-existent phone number.
Busy	The other party is busy. (Depending on the receiver's phone, this message might be displayed during packet communication as well.)
Busy with packet transmission	The packet communication is progress at the other end.
Out of service area/power off	The other party's phone is out of the service area or turned off.
Set caller ID to ON	Your caller ID is not notified. (when dialing "visualnet", etc.)
Your call is being forwarded	During forwarding
Redial using voice call	The other party activates Call Forwarding Service but the forwarding destination phone does not support videophone calls.
Upper limit has been exceeded Connection failed	The upper limit for the plan with the limit function (Type Limit, Family Wide Limit) is exceeded.
Please make your call from the i-mode web page	You did not make a videophone call from the IP (Information Provider) site among i-mode official sites (at dialing to V-live).
Connection failed	Redial after setting "Activate" of "Caller ID notification" to "ON". <ul style="list-style-type: none"> <li>This may appear in the case other than above.</li> </ul>

### Auto-redialing

If "Voice call auto redial" is set to "ON", and a videophone call is not connected, a voice call is automatically made.

- Videophone calls cannot be connected to the phones that do not support the videophone function, or to the phones that are out of the service area or turned off even if they are videophones. If you have set "Voice call auto redial" to "ON" and attempt to dial a phone that does not have the videophone function, the number will be redialed as a voice call. However, this operation might not work if you call the phone connected with ISDN-synchronous 64K or the ISDN videophone that does not support 3G-324M (as of June 2008), or if you dial the wrong number. Note that you could be charged for the communication.

### Function Menu while Entering Phone Number

Function menu	Operation/Explanation
<b>Notify caller ID</b>	See page 56.
<b>Prefix numbers</b>	See page 60.
<b>Int'l dial assist</b>	See page 59.
<b>Select image</b>	See page 75.
<b>Multi number</b>	You can select a phone number to be notified to the other party. (See page 396.)
<b>Add to phonebook</b>	See page 82.
<b>Compose message</b>	You can compose a mail message to send to the phone number set as the destination address. Go to step 3 on page 174.
<b>Chaku-moji</b>	See page 54.



## Switching between a Voice Call and a Videophone Call

You (caller) can switch between a voice call and a videophone call. This function is available for the mobile phones that can switch between a voice call and a videophone call.

### Switch from a Voice Call to a Videophone Call

When the other party's phone has a function to switch between the calls, "**V. phone**" is displayed on your phone and you can switch from the voice call to videophone call.

#### 1 During a voice call **Change**

- When you select an image to be sent to the other party, select "Select image". Go to step 2 on page 75.
- When "Cancel" is selected, the FOMA phone cancels switching and returns to the voice call.
- While switching, the voice guidance is played back.



### Switch from a Videophone Call to a Voice Call

When the other party's phone has a function to switch between calls, you can switch from a videophone call to a voice call by selecting "**CHG to voice call**" from the Function menu.

#### 1 During a videophone call **FUNC** ▶ **CHG to voice call** ▶ **YES**

- Select "NO" on the confirmation display to stop switching and to resume the videophone call.
- While switching, the voice guidance is played back.

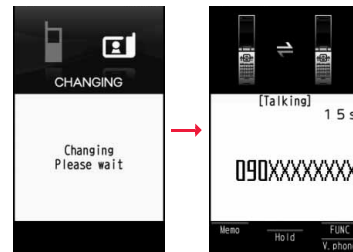

#### Information

- You can switch between a voice call and a videophone call repeatedly.
- When i-mode or packet communication is in progress, the communication is disconnected and then the voice call is switched to the videophone call.
- When packet communication is in progress at the other end, the message to the effect that the communication cannot be switched is displayed and the voice call continues without switching to the videophone call.
- You cannot switch from a voice call to a videophone call while "Multi calling" is displayed during a call if you have signed up for Call Waiting Service.
- It takes about five seconds to switch. Switching may take a longer time depending on the radio wave conditions.
- Depending on how the caller's phone is working or on the radio wave conditions, switching between a voice call and a videophone call may fail and the connection may be cut off.
- If you switch between a voice call and a videophone call during a call, the call duration and call cost are counted respectively for each call. You are not charged while "Changing" is displayed.

**Information**

- You cannot switch between a videophone call and a voice call unless "Notify switchable mode" on page 75 is set to "Indication ON" at the other end. Also, you cannot switch to a videophone call when "Reject videophone" on page 125 is set to "ON" at the other end.
- When you switch from a videophone call to a voice call, Hands-free is deactivated.

&lt;Redial&gt; &lt;Diald Calls&gt; &lt;Received Calls&gt;

**Using Call Records**

The FOMA phone can store the other party's phone number and date/time you have dialed or received. You can call back to the other party.

**■ Redial**

Up to 30 records of dialed voice calls and videophone calls are stored in total, and the older record of dialing to the same phone number is deleted.

**■ Dialed Calls**





Up to 30 records of dialed voice calls and videophone calls are stored in total, and up to 30 records of 64K data and packet communications are stored in total as well. The older records of dialing to the same phone number are also retained.





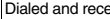

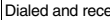

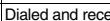
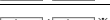
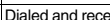



**■ Received Calls**

Up to 30 records of incoming voice calls and videophone calls are stored in total, and up to 30 records of 64K data and packet communications are stored in total as well. The older records coming from the same phone number are also retained.

- When a call is switched between a voice call and a videophone call, the call that is dialed/received first is stored.
- When more than 30 calls are dialed, the older records are automatically deleted. Even if you turn off the FOMA phone, call records are not deleted.
- In Dual Mode of 2in1, up to 60 redial items, 90 dialed call records, and 120 received call records for Number A and Number B are stored in total.

**■ Icons for Redial, Dialed Calls, and Received Calls**

 / 	Dialed and received calls/missed calls of voice call
 / 	Dialed and received calls/missed calls of videophone call
	Voice/Video messages are recorded on Record Message
 / 	Dialed and received calls/missed calls of international call
 / 	Dialed and received calls/missed calls of international videophone call

 / 	Dialed calls of 64K data communication
 / 	Received calls/missed calls of 64K data communication
 / 	Dialed calls of packet communication
 / 	Received calls/missed calls of packet communication
	Received calls of 64K data communication and packet communication when no external device is connected
	Received Chaku-moji message
	Records with time difference corrected
	Records for Number B (only in Dual Mode of 2in1)

\* The unchecked missed call icons are highlighted.

**Use Redial/Dialed Calls****1****When Using Redial**

Press .

**When Using Dialed Calls**

 **▶ Phonebook ▶ Dialed/recv. calls ▶ Dialed calls**

The list for call records is displayed.

- Press  (Change) to display the Sent Address list.

Redial 1/2	
	11/18 10:00 XXXXXXXXXX
	11/18 9:50 DOCOMO Taro
	11/18 9:30 DOCOMO Jiro
	11/18 9:20 09XXXXXXXXXX

For Redial

**2****Select a call record.**

The detailed display for the call record is displayed.

- When the other party is stored in the Phonebook, the phone number, name, and icon are displayed. If the same phone number is stored with multiple names in the Phonebook, the name and icon that come first in the search order (see page 84) are displayed.





Redial 2/7	
11/18 (Tue) 9:50	
DOCOMO Taro	
	09XXXXXXXXXX

For Redial

## Use Received Calls

MENU 2 4

### 1 Press .

- You can display the Received Call list also by  
 Phonebook  Dialed/recv. calls  Received calls  
 All calls or Missed calls.

All calls . . . . . All the records including missed calls  
 Missed calls . . . The records of missed calls only  
 In Dual Mode of 2in1, the number of missed calls for  
 Number A and Number B is displayed respectively.

(If unchecked missed calls are found, the number of them is displayed.)

- Press  (Change) to display the Received Address list.



### 2 Select a received call record.

- The other party's phone number is displayed if it is provided.

If this caller is stored in the Phonebook, the phone number, name, and icon are displayed. If the same phone number is stored with multiple names in the Phonebook, the name and icon that come first in search order (see page 84) are displayed.



If there is a call for packet communication, the sender's access point name (APN) is displayed.

When the other party's phone number is not notified, the reason for no caller ID is displayed.



- For missed calls, the ring time is displayed on the right of the received date/time.
- When a Chaku-moji message is received, it is displayed.



## To make a call to a displayed redial item, dialed call record, or received call record

Press  to make a voice call. You can make a voice call also by pressing  (Dial) from the detailed display. Press  (V. phone) to make a videophone call.

### Information

- You can make a voice call to the most recently dialed or received number by pressing  from the Stand-by display and then .

### Information

- When you make/receive a call with an additional number of Multi Number, the stored name for the additional number is displayed below the phone number on the detailed display. If you store a phone number for "Number setting" of "Multi number", the phone number is displayed as well.
- Even if you make a voice call (or videophone call) to the phone number in a received call record with a Chaku-moji message displayed, the received message is not sent.
- When a call comes in from a party who uses a dial-in phone number, a different phone number might be displayed.

## Function Menu while Redial/Dialed Calls/Received Calls is Displayed

Function menu	Operation/Explanation
Notify caller ID	See page 56.
Prefix numbers	See page 60.
Int'l dial assist	See page 59.
2in1 dial	You can select a phone number to be notified to the other party in Dual Mode of 2in1. (See page 398)
Multi number	You can select a phone number to notify the other party. (See page 396)
Chaku-moji	See page 54.
Character size	You can switch the character size for the list. (See "Dialed/recv. calls" on page 111)
Add to phonebook	See page 82. <ul style="list-style-type: none"> <li>You can store the phone number in the Phonebook also by pressing  (Store) from the detailed display. Go to step 2 on page 82.</li> </ul>
Ring time	You can display the ring time for missed calls. Even if you have set "Missed calls display" of "Ring time" to "Not display", the missed calls which stopped ringing within the ring start time and their ring times are displayed.
Add desktop icon	See page 109.
Compose message	You can compose a mail message to send to the phone number set as the destination address. Go to step 3 on page 174.

Function menu	Operation/Explanation
<b>Compose SMS</b>	You can compose an SMS message to send to the phone number set as the destination address. Go to step 3 on page 214.
<b>Sent address</b> [Redial/Dialed Calls only]	See page 200.
<b>Received address</b> [Received Calls only]	See page 200.
<b>Delete this</b>	▶ YES
<b>Delete selected</b>	▶ Put a check mark for redial items, dialed call records, or received call records to be deleted ▶  (Finish) ▶ YES
<b>Delete all</b>	▶ Enter your Terminal Security Code ▶ YES
<b>Select image</b>	See page 75.

### Information

#### <Delete this> <Delete selected> <Delete all>

- If you execute "Delete all" from the Function menu of Redial/Dialed Calls, all records in both Redial and Dialed Calls are deleted. Even if you execute "Delete this" or "Delete selected" of Redial, the records are not deleted from Dialed Calls and they are retained. To delete the dialed call records, delete them from the Function menu while "Dialed calls" is displayed.

### <Chaku-moji>

## Using Chaku-moji

When making a voice call or videophone call, you can send your text message to tell the subject during calling.

- For details on Chaku-moji or compatible models, refer to DOCOMO web page or "Mobile Phone User's Guide [Network Services]".
- The sending end is charged, but the receiving end is not charged.

### When a message is received



A Chaku-moji message is displayed below a caller. The Chaku-moji message is stored in Received Calls as well.

- The Chaku-moji message is displayed only during ringing. It is not displayed during a call.
- Even when a Chaku-moji message comes in within the ring start time set by "Ring time", it is received and recorded in Received Calls.
- The Chaku-moji message is not displayed during Lock All, Omakase Lock, or Personal Data Lock. However, you can check the Chaku-moji message from Received Calls after the lock is released.



## Store Messages

You can store up to 10 Chaku-moji messages in the Message list.

- 1  ▶ Service ▶ Chaku-moji ▶ Create message  
▶ Highlight <Not stored> and press  (Edit)  
▶ Enter a message.

- To edit a stored message, highlight it and press  (Edit).
- You can enter up to 10 characters regardless of whether they are pictographs, symbols, or full-pitch/half-pitch characters.

## Make a Call with a Message

- 1 Enter a phone number  
or  
bring up the detailed display of a Phonebook entry, redial item, dialed call record, or received call record.

## 2 (FUNC) ▶ Chaku-moji ▶ Do the following operations.

Function menu	Operation/Explanation
<b>Create message</b>	<p>You can create a Chaku-moji message just before dialing.</p> <p>▶ <b>Enter a message.</b></p> <ul style="list-style-type: none"> <li>You can enter up to 10 characters regardless of whether they are pictographs, symbols, or full-pitch/half-pitch characters.</li> <li>The Chaku-moji message created using this function is not stored in the Message list.</li> </ul>
<b>Select message</b>	<p>From the Message list, you can select a stored message.</p> <p>▶ <b>Select a message.</b></p>
<b>Sent messages</b>	<p>From the Sent Message list, you can select a Chaku-moji message to be sent. Up to 10 sent Chaku-moji messages only are stored in the Sent Message list. If you send the same Chaku-moji message, the older one is deleted. When the number of sent Chaku-moji messages exceeds 10, the messages are deleted from the oldest one.</p> <p>▶ <b>Select a sent message.</b></p>

## 3 Press or .

- Press  (V. phone) to make a videophone call.
- The Chaku-moji message being sent is displayed during dialing.

### Information

- When a Chaku-moji message has arrived at the other party's phone, "Transmission completed" is displayed, and you are charged a transmission fee.
- When a Chaku-moji message does not arrive at the other party's phone such as when the other party's phone is not a Chaku-moji compatible mobile phone or the call is not allowed by "Message disp. settings" at the receiving end, "Transmission failed" is displayed. In this case, you are not charged a transmission fee.
- Depending on the radio wave conditions, the transmission result may not be displayed at the sending end even if a Chaku-moji message has arrived at the other party's phone. In this case, you are charged a transmission fee.
- Even if you make a call sending a Chaku-moji message, the Chaku-moji message is not displayed and you are not charged a transmission fee (the call is not recorded in Received Calls at the receiving end) when the other party's phone is out of the service area, turned off, during Public Mode (Drive Mode), or the ring time for Record Message Setting is set to zero seconds. Also, the transmission result is not displayed at the sending end.

### Information



- When a videophone call is not connected and automatically dialed as a voice call, the Chaku-moji message is resent as well.
- You cannot send/receive Chaku-moji messages overseas.

### Detailed Sent Message



Up to 10 sent Chaku-moji messages are stored in Sent Messages, and you can check for the other party's phone number and the date/time the Chaku-moji messages were sent. Older messages sent to the same phone number are also retained.

- In Dual Mode of 2in1, up to 10 records for Number A and Number B can be displayed in total.

## 1 ▶ Service ▶ Chaku-moji ▶ Sent messages

-  . . . . Chaku-moji message successfully sent
-  . . . . Chaku-moji message unsuccessfully sent

 . . . . . Chaku-moji message for Number B (only in Dual Mode of 2in1)

- When the transmission result is not displayed, " " or " " is not displayed.
- Depending on the radio wave conditions, the transmission result might not be displayed correctly.

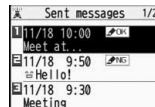

## 2 Select a sent message.

- When the other party's phone number is stored in the Phonebook, the phone number, name, and icon are displayed.



### Function Menu while Detailed Sent Message is Displayed

Function menu	Operation/Explanation
<b>Store</b>	<p>You can store a sent Chaku-moji message in the Message list.</p> <p>▶ <b>&lt;Not stored&gt;</b></p> <ul style="list-style-type: none"> <li>You can store also by pressing  (Store).</li> </ul>

Function menu	Operation/Explanation
Delete this	▶ YES
Delete all	▶ Enter your Terminal Security Code ▶ YES

## Message Display Settings

You can set how incoming Chaku-moji messages are displayed.

- 1**  ▶ **Service** ▶ **Chaku-moji** ▶ **Message disp. settings**  
▶ Select an item.

**Display all messages** . . . . . Displays Chaku-moji messages from all callers.

**Numbers stored in PB** . . . . . Displays Chaku-moji messages only from the callers stored in the Phonebook.

**Calls with callerID** . . . . . Displays Chaku-moji messages only from the caller notifying his/her phone number.

**Hide all messages** . . . . . Does not display Chaku-moji messages.

### Information

- When you set to "Numbers stored in PB", you cannot receive Chaku-moji messages from the callers stored in the Phonebook B in A Mode of 2in1 (and vice versa).

## Prefer Chaku-moji

You can set how your FOMA phone works for incoming Chaku-moji messages for when "Setting when opened" is set to "Answer".

- 1**  ▶ **Service** ▶ **Chaku-moji** ▶ **Prefer Chaku-moji**  
▶ **ON or OFF**

**ON** . . . . . Does not answer by opening the FOMA phone during ringing, so you can check a Chaku-moji message.



**OFF** . . . . . Answers by opening the FOMA phone during ringing.

<186/184>

## Notifying/Not notifying Your Phone Number by Call

### Set Caller ID Notification when Making a Call

Each time you dial out, you can set whether to notify your caller ID.

- 1** Enter a phone number  
or  
bring up the detailed display of a Phonebook entry, redial item, dialed call record, or received call record.
- 2**   ▶ **Notify caller ID**  
▶ **Don't notify or Notify caller (OFF or ON)**

- To release "Notify caller ID", select "Cancel prefix". Whether to notify or not follows the setting for "Activate" of "Caller ID notification".



### Set "Notify/Not Notify" by Entering "186/184"

You can select whether to notify the other party of your phone number also by entering "186"/"184" before the other party's phone number.

#### To notify your caller ID

- 1** **186** → **Destination phone number** ▶  or  **(Dial)**
- Press  (V. phone) to make a videophone call.

#### Not to notify your caller ID

- 1** **184** → **Destination phone number** ▶  or  **(Dial)**
- Press  (V. phone) to make a videophone call.

## Information

- When you make a call and hear the guidance requesting your caller ID (see page 392), follow the steps of "To notify your caller ID" to enter "186" and redial.
- You cannot set "Caller ID notification" while "☎" is displayed.

<Pause Dial>

MENU 8 4

## Sending Touch-tone Signals

You can send touch-tone signals from your FOMA phone to use services such as reserving tickets, checking bank balance, etc.

### Store Pause Dial

You need to store a number string to be sent as a touch-tone signal in the Pause Dial list. If you have inserted a pause (p), you can send a number string breaking at the point where the pause is inserted.

1 ► Settings ► Other settings ► Pause dial ► (Edit)

- When a number string is already stored, it is displayed.
- To delete a stored pause dial, press (FUNC) and select "Delete", then select "YES".

2 Enter a number string.

- Enter the pause (p) by pressing and holding for at least one second.
- You can use only through , , to enter a number string and the pause (p).
- You can enter up to 128 digits.
- You cannot enter a pause (p) at the beginning and end of a number string, or enter it consecutively.

### Send Pause Dial

1 ► Settings ► Other settings ► Pause dial ► (Send)  
► Enter a phone number ► or (Dial)

A voice call is made. Once the line is connected, a number string stored in Pause Dial is displayed up to the first pause (p).

- When the other party's phone number is stored in the Phonebook, you can retrieve it selecting from the Search Phonebook display by pressing .
- You can search for the phone number also from Received Calls by pressing or from Redial by pressing .

2 Check that the line is connected ► or (Send)

A number string up to the first pause (p) is sent, and a number string up to the next pause (p) is displayed.

A number string up to the pause (p) is sent each time you press or (Send).

When you have finished sending the last number, the "Talking" display appears.

- To send multiple pieces of a number string at a time, press and hold for at least one second, and select "Send at one time".

## Information

- During a call, you can send a number string also by displaying the Function menu of the Pause Dial display.
- Some devices on the receiving end cannot receive signals.
- You cannot send a number string with pauses during a videophone call.

## &lt;WORLD CALL&gt;



## International Calls

WORLD CALL is the international call service available from DOCOMO mobile phones.

When you have signed up for FOMA service, you have contracted to use "WORLD CALL" (except those who have applied not to use it).

- You can call about 240 countries and regions.
- The WORLD CALL charges are added to your monthly FOMA bill.
- The application/monthly fee is free of charge.
- The service is not available with some billing plans.
- Contact "DOCOMO Information Center" on the back page of this manual for inquiries about WORLD CALL.
- When using international carriers other than DOCOMO, contact them.

## About international videophone calls

You can make international videophone calls to the other party who uses a specific 3G mobile phone overseas. Press  (V. phone) instead of  or  (Dial) in the steps of "Enter a Phone Number to Make an International Call". (See page 58)

- For the information about connectable countries and telecommunications carriers, refer to the DOCOMO Global Service web page.
- Images sent from the other party may blur on your FOMA phone or you may not be able to connect, depending on the other party's phone used for the international videophone call.

## Enter a Phone Number to Make an International Call

**1** Enter numbers in order of 010→country code  
→area code (city code)→destination phone number

▶  or  (Dial)

- You can make an international call also by entering 009130→010→country code→area code (city code)→destination phone number.
- When the area code (city code) begins with "0", enter it except for the "0". However, include "0" when making a call to some countries or regions such as Italy.
- Press  (V. phone) to make an international videophone call.

## Use "+" to Make an International Call

When you enter a phone number for dialing or storing it in the Phonebook, press and hold  for at least one second to enter "+". You can use "+" to make international calls without entering an international call access code.

- If you set "Auto assist setting" of "Int'l dial assist" to "ON", an international call access code of "IDD prefix setting" is automatically entered.

**1**  (for at least one second)  
▶ Enter numbers in order of country code  
→area code (city code)→destination phone number

▶  or  (Dial) ▶ Dial

- When the area code (city code) begins with "0", enter it except for the "0". However, include "0" when making a call to some countries or regions such as Italy.
- Press  (V. phone) to make an international videophone call.
- When you select "Dial with orig. No.", you can make a call without adding an international call access code.



## International Dial Assist

You can make a call adding a country code or international call access code to a phone number. (Except for some countries and regions, if the phone number starts with "0", the "0" at the beginning is automatically deleted.)



### 1 Enter a phone number

or

bring up the detailed display of a Phonebook entry, redial item, dialed call record, or received call record.

### 2 ► Int'l dial assist ► Select a country name

► Select a name ►  or  

- Press   to make an international videophone call.
- When the beginning of the phone number is "+", you can select only an international call access code.
- When "Japan" is selected as a country name, the display for selecting a name is not displayed.

<International Dial Assist>

## Setting for International Calls

### Auto Assist Setting

You can set whether to replace "+" at the beginning of a phone number with an international call access code for when you make an international call from Japan.

### 1 ► Settings ► Network setting ► Int'l dial assist

► Auto assist setting ► ON or OFF

► Select a country name ► Select a name.

- When no country code or international call access code is stored, the confirmation display appears asking whether to store it. Select "YES" and go to step 2 of "Country Code Setting" on page 59 for a country code, and go to step 2 of "IDD Prefix Setting" on page 59 for an international call access code.

## Country Code Setting

You can store up to 27 country codes to be added for making international calls from overseas.

### 1 ► Settings ► Network setting ► Int'l dial assist

► Country Code set.

► Highlight <Not recorded> and press  .

- If you select a stored country name, you can check the stored contents.

### 2 Enter a country name ► Enter a country code.

- You can enter a country name of up to 8 full-pitch/16 half-pitch characters.
- You can enter a country code of up to 5 digits. But you cannot use #, \*, and +.

## IDD Prefix Setting

You can store up to three international call access codes to be added to the beginning of a phone number for making an international call.

### 1 ► Settings ► Network setting ► Int'l dial assist

► IDD prefix setting



► Highlight <Not recorded> and press  .

- If you select the stored item, you can check the stored contents.

### 2 Enter a name ► Enter an international call access code.

- You can enter a name of up to 8 full-pitch/16 half-pitch characters.
- You can enter an international call access code of up to 16 digits.

## Function Menu while Country Code Setting /IDD Prefix Setting is Displayed

Function menu	Operation/Explanation
Edit	Go to step 2 of "Country Code Setting" on page 59 for Country Code Setting, and go to step 2 of "IDD Prefix Setting" on page 59 for IDD Prefix Setting. • You can edit the item also by pressing   .

Function menu	Operation/Explanation
Delete this	▶ YES
Delete all	▶ Enter your Terminal Security Code ▶ YES

### Information

<Delete this> <Delete all>

- You cannot delete the country code or international call access code set by "Auto assist setting".

### <Prefix Setting>

## Storing Numbers to be Added to the Beginning of a Phone Number

You can store prefix numbers such as international call access codes or "186"/"184" and add them to the phone number for dialing. You can store up to seven prefix numbers.

**1** ▶ Settings ▶ Network setting ▶ Prefix setting  
▶ Highlight <Not recorded> and press (Edit).

- If you select a stored prefix, you can check the stored contents.
- To delete a stored prefix, press and select "Delete this" or "Delete all" then select "YES". If you select "Delete all", you need to enter your Terminal Security Code.

**2** Enter a name ▶ Enter a prefix number.

- You can enter a name of up to 8 full-pitch/16 half-pitch characters.
- You can enter a prefix number of up to 16 digits. The keys for entry are limited to through , , and .

### Prefix Numbers

You can add a prefix number to the beginning of phone number when you make a call.

**1** Enter a phone number  
or

bring up the detailed display of a Phonebook entry, redial item, dialed call record, or received call record.

**2** (FUNC) ▶ Prefix numbers ▶ Select a name  
▶ or (Dial)  
• Press (V. phone) to make a videophone call.

### <Sub-address Setting>

## Making a Call with Specified Sub-address

You can set whether to regard the numbers after "X" of a phone number as a sub-address to access the specified phones or data terminals.

- The sub-address is a number assigned to identify each ISDN terminal connected to an ISDN line. It is also used for selecting contents on "V-live".

**1** ▶ Settings ▶ Other settings ▶ Sub-address setting  
▶ ON or OFF

### Information

- Even if you set "Sub-address setting" to "ON", "X" at the top of phone numbers and "X" immediately after the prefix number or "186"/"184" are not regarded as sub-address mark-off symbols.

### <Reconnect Signal>



## Setting Alarm for Reconnecting

You can set an alarm that sounds until a voice call, or videophone call is reconnected after disconnected owing to bad radio wave conditions.

**1** ▶ Settings ▶ Talk ▶ Reconnect signal  
▶ Select an alarm.

### Information

- The reconnectable time differs depending on the usage status and radio wave conditions. An estimate is about 10 seconds and the call charge is applied also for that duration.
- While you are disconnected, no sound is transmitted to the other party.

## <Noise Reduction>



# Reducing Surrounding Noise to Make Voice Clear

The noise sent to the other party is reduced according to the surrounding noise during a call.

1 ► Settings ► Talk ► Noise reduction ► ON or OFF

## <Hands-free>

# Switching to Hands-free

When you switch to Hands-free, sound such as the other party's voice is audible over the speaker.

1 During a call, dialing, or connecting

When Hands-free is activated, is displayed.

- Press again to deactivate Hands-free.
- The sound volume during a Hands-free call follows the setting specified by "Volume" (earpiece volume).
- You can switch to Hands-free even during Manner Mode. Also, you will still hear voice through the speaker even when you activate Manner Mode during a Hands-free call.

### Information

- While the Flat-plug Earphone/Microphone with Switch (option) is connected, you cannot hear voice through the speaker even if you switch to Hands-free.
- Keep the FOMA phone well away from your ear during a Hands-free call. Otherwise you could affect or damage your hearing.
- Talk into the FOMA phone within a distance of about 50 cm.

## <In-Car Hands-free>

# Using Hands-free Compatible Devices

You can make or receive voice calls from a Hands-free compatible device such as In-Car Hands-Free Kit 01 (option) or a car navigation system by connecting with your FOMA phone.

### ● Connect using a cable (USB connection):

To use/charge via the In-Car Hands-Free Kit 01 (option), you need to have the FOMA In-Car Hands-Free Cable 01 (option).

※ For how to operate Hands-free compatible devices, refer to the respective instruction manuals.

### Information

- To connect using a cable (USB connection), set "USB mode setting" to "Communication mode".
- appears while you are talking or communicating using a USB Hands-free compatible device.
- might appear while the FOMA phone is connected to a USB Hands-free compatible device, and while "USB mode setting" is set to "microSD mode", depending on the Hands-free device connected.
- The display or ring tone for incoming calls follows the settings of the FOMA phone.
- When the sound is set to output from a Hands-free compatible device, the ring tone sounds from that device even when Manner Mode is activated or "Ring volume" of the FOMA phone is set to "Silent".
- The receiving operation in Public Mode (Drive Mode) works in accordance with the "Public (Drive) mode" setting.
- The receiving operation while Record Message is activated works in accordance with the "Record message setting" setting.
- When the sound is set to output from the FOMA phone, the FOMA phone works in accordance with "Setting when folded" if it is closed during a call. When the sound is set to output from a Hands-free device, the communication state does not change regardless of "Setting when folded" even if you close the FOMA phone.

## Receiving a Call/Videophone Call

### 1 When you receive a call, the ring tone sounds and the Call/Charging indicator flickers.

- To vibrate the FOMA phone for incoming calls, set "Phone" or "Videophone" of "Vibrator" to other than "OFF".
- When receiving a videophone call, "Incoming V.phone" is displayed.
- "[Call icon]" is displayed at the upper left of the phone number for incoming international calls.



Chaku-moji message  
(See page 54)

### 2 For Answering a Voice Call

Press or (Answer) to answer the call.



### For Answering a Videophone Call

Press or (Answer) to answer the videophone call.

The substitute image is sent to the other party.

- Press during a call to switch between the substitute image and image through your camera for sending to the other party.



### 3 Press to end the call after talking.

#### Information

- If you close the FOMA phone during a call, the FOMA phone works in accordance with the setting of "Setting when folded". (See page 64)
- You might hear beeps (in-call ring tone) during a call.  
If you have signed up for any of Voice Mail Service, Call Waiting Service, or Call Forwarding Service and set "Arrival call act" to "Answer", the beeps (in-call ring tone) will sound for another incoming call, enabling you to do the following operations:  
Voice Mail Service  
... Transfer the call to the Voice Mail Service Center. (See page 387)  
Call Waiting Service  
... Put your current call on hold and answer the incoming call. (See page 388)  
Call Forwarding Service  
... Transfer the call to the registered forwarding destination. (See page 391)
- You can set "Reject unknown" not to accept calls from the phone numbers that are not stored in the Phonebook.

## Information

### <For Voice Calls>

- When "Answer setting" is set to "Any key answer", the call is placed on hold if you answer the call by pressing  with the FOMA phone closed. If you have set "Setting when folded" to "No tone" or "End the call", the other party hears nothing, and if you have set "Setting when folded" to "Tone on", the call hold tone is played back. You can start talking by opening the FOMA phone.

### <For Videophone Calls>

- Just after purchase, Hands-free is automatically activated during a videophone call as "Hands-free w/ V. phone" has been set to "ON". (See page 74) However, Hands-free is deactivated during Manner Mode regardless of "Hands-free w/ V. phone".
- Even if Call Forwarding Service is set to "Activate", the call is not forwarded unless the forwarding destination is a phone compatible with the videophone conforming to 3G-324M (see page 48). Check the phone you are forwarding the call to and then activate the service. The videophone caller does not hear the guidance to the effect that the call is forwarded. (The message to the effect that the call is to be forwarded appears, depending on the receiver's FOMA phone.)
- If a videophone call comes in from the phone number to be rejected by Nuisance Call Blocking Service, the video guidance for Call Rejection is played back and the call is disconnected.

## Display for incoming calls

### When a caller's phone number is provided

If you store the caller's name, phone number, and image in the Phonebook, the name, phone number, and icon (or image) are displayed.

- If the same phone number is stored with multiple names in the Phonebook, the name that comes first in the search order (see page 84) is displayed.
- The phone number but not the name is displayed during Personal Data Lock.
- For a forwarded call, the forwarder's phone number is displayed below the caller. (It might not be displayed in the case of some forwarders.)
- When you receive a call to an additional number of Multi Number, the stored name for the additional number is displayed below the caller. (With a forwarded call, you can press  (Change) to switch to display of the forwarder.)

### When a caller's phone number is not provided

The reason for no caller ID is displayed. (See page 123)

## Function Menu while a Call is Ringing

Function menu	Operation/Explanation
Call rejection	You can disconnect the call without answering.
Call forwarding	See page 391.
Voice mail	See page 387.

## Switched between a Voice Call and a Videophone Call by the Other Party



When you have set "Notify switchable mode" to "Indication ON", a caller (the other party) can switch between a voice call and a videophone call. When the caller (the other party) switches between a voice call and a videophone call, the message telling that the call is being switched is displayed, the voice guidance is played back, and then the call is switched.

- You (receiving end) cannot switch between a voice call and a videophone call.

### <Answer Setting>

MENU 5 8

## Setting Response of Key Operation for Answering Incoming Calls



You can set to start talking (Any key answer) or to stop the ring tone (Quick silent) by pressing a key besides  and  for when a call comes in.

-  ► Settings ► Incoming call ► Answer setting  
► Select a key operation.

### Any key answer

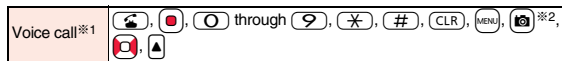
You can start talking by pressing any key shown below:



- When receiving a videophone call, you can start talking by pressing  or .

**Quick silent**

The following are the keys you can press to stop the ring tone, vibrator or voice guidance:

When "Setting when opened" is set to "Keep ringing", you can open the FOMA phone to stop the ring tone, vibrator or voice guidance. Even if you stop it, the other party still hears a calling tone.

Voice call※1	through  ,  ,  ,  ,  ,  ※2 ,  ,
Videophone call	through  ,  ,  ,  ,  ※2 ,  ,

- After you stop the ring tone, vibrator or voice guidance, you can start talking by pressing or .

**OFF**

You can start talking by pressing a key shown below:

Voice call	.
Videophone call	

※1 You can activate Any Key Answer or Quick Silent also by pressing when five record messages have already been recorded.

※2 While "Change" is displayed, you cannot start talking or stop the ring tone, vibrator or voice guidance.

**Information**

- While the Flat-plug Earphone/Microphone with Switch (option) is connected, you can press the switch to start talking, regardless of "Answer setting". (See page 371)

## &lt;Setting when Opened&gt;

**Setting Response for when Opening FOMA Phone during Ringing**

- **Settings** ► **Incoming call** ► **Setting when opened**  
► **Select an incoming type** ► **Keep ringing or Answer**

## &lt;Setting when Folded&gt;

MENU 1 8

**Setting Response for when Closing FOMA Phone during a Call**

- **Settings** ► **Talk** ► **Setting when folded**  
► **Select an item.**

**No tone** . . . . . The voice is muted. The hold tone does not sound. The setting is completed.

**Tone on** . . . . . The other party hears the hold tone set for "Holding tone" of "Set hold tone" while the FOMA phone is closed.

**End the call** . . . The call is finished. This is the same operation as pressing during a call. The setting is completed.

- Speaker ON or Speaker OFF**

**Speaker ON** . . . . The hold tone sounds from the speaker.

**Speaker OFF** . . . The hold tone does not sound from the speaker.

**Information**

- This function is disabled when the Flat-plug Earphone/Microphone with Switch (option) is connected. The communication state does not change even if you close the FOMA phone during a voice call. If you close the FOMA phone during a videophone call, the substitute image is sent to the other party with the line connected.
- If you close the FOMA phone during a videophone call with "No tone" set, the substitute image is sent to the other party. When "Tone on" is set, the still image set for "Holding" of "Select image" is sent.

## &lt;Volume&gt;

**Adjusting Earpiece Volume**

- **Settings** ► **Talk** ► **Volume**  
► Use or / to adjust the earpiece volume.

Adjust the earpiece volume to Level 1 (minimum) through Level 6 (maximum).

- During a call or calling, you can press or / to adjust the volume, and while entering phone number, you can press and hold (for at least one second) to adjust it. Press or / within two seconds to adjust it.

## Information

- The earpiece volume adjusted during a call is retained even after the call ends.
- When you adjust the earpiece volume, the sound volume during a Hands-free call is also adjusted.

<Ring Volume>



## Adjusting Ring Volume

You can adjust the ring volume for incoming calls and mail.

1 ► **Settings** ► **Sound** ► **Ring volume**

► **Select an incoming type**

► Use to adjust the volume.

- Following icons are displayed on the Stand-by display while the ring volume is set to "Silent":

: The ring volume for voice calls or videophone calls is "Silent".

: The ring volume for mail, chat mail or Messages R/F is "Silent".

: The ring volume for voice calls or videophone calls is "Silent" and the ring volume for mail, chat mail, or Messages R/F is "Silent".

- If you have set "Step", the ring tone is silent for about three seconds, and then the volume steps up every three seconds, from Level 1 through Level 6.

- During ringing of a voice call or videophone call, you can adjust the ring volume also by pressing or by pressing and holding / for at least one second. However, you cannot adjust the ring volume in the following cases:

- When Ring Volume is set to "Step"
- When "Answer setting" is set to "Quick silent" and you stop the ring tone or voice guidance
- During Manner Mode
- When a call is cut off within the ring start time specified by "Ring time"

<On Hold>

## Putting an Incoming Call on Hold when You cannot Answer at Once

1 **During ringing** ►

The FOMA phone makes three rapid beeps for confirmation and the call is put on answer-hold (On Hold).

- The confirmation tone does not sound during Manner Mode or when "Ring volume" is "Silent".
- The other party hears the hold tone set for "On hold tone" of "Set hold tone". For videophone calls, the still image set for "On hold" of "Select image" is displayed.

2 **Press** or (**Answer**) **to release hold and answer the call.**

- If "Answer setting" is set to "Any key answer", you can release hold of voice calls by pressing any key of through , , , , , , , , , or .
- If you release hold of videophone calls, the substitute image is sent to the other party.

## Information

- The caller is charged for the call even during answer-hold (On Hold).
- If you press during answer-hold (On Hold), the call will be disconnected.

<Holding>

## Putting a Call on Hold during a Call

1 **During a call** ► (**Hold**)

- The other party hears the hold tone set for "Holding tone" of "Set hold tone". For videophone calls, the still image set for "Holding" of "Select image" is displayed.
- You can put the call on hold by closing the FOMA phone during the call if you have set "Setting when folded" to "Tone on".

## 2 Press or (Answer) to release hold and answer the call.

- If you release hold of videophone calls, the substitute image is sent to the other party.
- If you have set "Setting when folded" to "Tone on" and put the call on hold by closing the FOMA phone, open the FOMA phone or connect the Flat-plug Earphone/Microphone with Switch (option) to answer the call.  
If you connect the Flat-plug Earphone/Microphone with Switch to answer the videophone call, the substitute image is sent to the other party.

### Information

- The caller is charged for the call even while the call is on hold.
- If a new call comes in while the current call is put on hold, the hold (Holding) is released.

### <Set Hold Tone>

## Setting Hold Tone

You can set the guidance the other party hears during on hold.

## 1 Settings ▶ Talk ▶ Set hold tone ▶ On hold tone or Holding tone ▶ Select a hold tone.



**Tone 1/2** . . . The caller hears the pre-installed guidance in Japanese.

### JESU JOY OF MAN'S

. . . . . The caller hears the melody. You can set this for "Holding tone" only.

### Voice announce

. . . . . The caller hears the sound recorded by "Voice announce". If it has not been recorded, this is not displayed.

- Press  (Play) to play back a hold tone. Press  to end the demo playback.

### <Public Mode (Drive Mode)>

## Using Public Mode (Drive Mode)

**Public Mode is an auto-answer service that puts importance on manners in public spaces. Once you activate Public Mode, the guidance is played back telling that you cannot answer the call as you are currently driving or in a place (a train, bus, movie theater, etc.) where you should refrain from answering the call. Then the call is disconnected.**

## 1 Press and hold for at least one second.

Public Mode is activated and "" is displayed.

When a call comes in, the guidance "The person you are calling is currently driving or in an area where cell phone should not be used. Please try again later." is played back for incoming calls.

- To deactivate Public Mode, perform the same operation. Then, Public Mode is deactivated and "" disappears.

### Information

- You can activate/deactivate Public Mode only from the Stand-by display. You can activate/deactivate Public Mode even when "" is displayed.
- You can make calls as usual even during Public Mode.
- If you make an emergency call at 110/119/118, Public Mode is released.
- When Public Mode and Manner Mode are activated simultaneously, Public Mode has priority.
- If a "User unset" call comes in while "Caller ID request" is set to "Activate", the Caller ID Request guidance is played back. (The Public Mode guidance is not played back.)
- You cannot use this function during data communication.



### When Public Mode (Drive Mode) is activated

- Even when a call comes in, the ring tone does not sound. The "Missed call" icon appears on the display and the call is stored in "Received calls". The guidance is played back to the caller to the effect that you are currently driving or in an area where mobile phones should not be used. Then the call is disconnected.
- However, when the power is off or "🚫" is displayed, the caller hears the out-of-service area guidance instead of the Public Mode guidance.
- The ring tone does not sound and the Call/Charging indicator does not flicker even when mail or a message comes in. In addition, the set vibrator does not work.
- The ring tone for 64K data communication, alarm tone, and charging confirmation tone do not sound, and a melody while an i-appli program is running is not played back.
- The tickers of i-Channel are not displayed.
- See page 67 for how Public Mode (Drive Mode) and each network service work for incoming calls when they are simultaneously activated.

### <Public Mode (Power Off)>

## Using Public Mode (Power Off)

**Public Mode (Power Off) is an auto-answer service that puts importance on manners in public spaces. Once you activate Public Mode (Power Off), the guidance is played back telling that you cannot answer the call as you are currently in a place (hospital, airplane, around priority seat in a train, etc.) where use is prohibited. Then the call is disconnected.**

### 1 Enter "✖25251"

Public Mode (Power Off) is set. (Nothing is changed on the Stand-by display.) After setting Public Mode (Power Off) and turning off the power, the guidance "The person you are calling is currently in an area where use is prohibited. Please try again later." is played back for incoming calls.

- To release Public Mode (Power Off), dial "✖25250".
- To check the setting for Public Mode (Power Off), dial "✖25259".

### When Public Mode (Power Off) is activated

- The setting stays activated until you dial "✖25250" to deactivate Public Mode (Power Off). You cannot deactivate the setting just by turning on the power.
- The guidance is played back to the caller telling that you are currently in a place where you should turn off the power. Then the call is disconnected.
- The Public Mode (Power Off) guidance is played back even when you are out of the service area or out of reach of radio waves.
- See page 67 for how Public Mode (Power Off) and each network service work for incoming calls when they are simultaneously activated.

#### ■ The receiving operation during Public Mode (Drive Mode/Power Off)

Service	Responses to Incoming Voice Calls	Responses to Incoming Videophone Calls
Voice Mail Service*	Plays back the Public Mode guidance, and then the call is connected to the Voice Mail Service Center.	Does not play back the video guidance for Public Mode, and the call is connected to the Voice Mail Service Center.
Call Forwarding Service*	Plays back the Public Mode guidance, and then the call is forwarded to the forwarding destination. Whether the guidance is played back or not depends on the guidance setting of Call Forwarding Service. If "Plays guidance" is set, plays back the Public Mode guidance. If "Does not play guidance" is set, does not play back the guidance.	Does not play back the video guidance for Public Mode, and the call is forwarded to the forwarding destination. If the destination does not support videophone calls, the call is disconnected.
Nuisance Call Blocking Service	For the call from the phone number registered to be rejected, plays back the Call Rejection guidance, and then the call is disconnected.	For the call from the phone number registered to be rejected, plays back the video guidance for Call Rejection, and then the call is disconnected.

Service	Responses to Incoming Voice Calls	Responses to Incoming Videophone Calls
Caller ID Display Request Service	For the caller without a caller ID, plays back the Caller ID Request guidance, and then the call is disconnected. For the caller with a caller ID, plays back the Public Mode guidance, and then the call is disconnected.	For the caller without a caller ID, plays back the video guidance for Caller ID Request, and then the call is disconnected. For the caller with a caller ID, plays back the video guidance for Public Mode, and then the call is disconnected.





※ When the ring time is set to 0 seconds, the FOMA phone is out of the service area, or the power is off, the Public Mode guidance is not played back, but Voice Mail Service or Call Forwarding Service works. Note that in this case the call is not notified by the "Missed call" icon and not stored in "Received calls".

### <Missed Calls>

## If You could not Answer an Incoming Call

When you could not answer calls (Missed calls), the "Notification icon" appears on the Stand-by display. You can check Received Calls by selecting the icon.

**1**  (Select)

- Press  or  to return to the former display.
- When multiple icons are found, use  to highlight an icon and press .

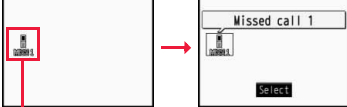

Notification icon

### <Record Message Setting>

MENU 5 5



## Recording Voice/Video Messages when You cannot Answer the Call

By activating Record Message, you can play back an answer message to incoming calls and record callers' voice/video messages when you cannot answer them even if you have not signed up for Voice Mail Service.





You can record up to five messages for voice calls and up to two messages for videophone calls. Each message can be recorded for up to 20 seconds.

### Activate Record Message

- 1**  ▶ LifeKit ▶ Rec. msg/voice memo  
▶ Record message setting ▶ ON or OFF  
▶ Select an answer message.

- Press   to play back the answer message. Press  to end the demo playback.
- When "Japanese 1", "Japanese 2", or "English" is set, a beep sounds after playing back the answer message to the other party. If "Voice announce" is set, the beep does not sound.

### 2 Enter a ring time (seconds).

- Enter from "000" through "120" in three digits.
- You cannot set the same ring time for Auto Answer Setting and Record Message Setting. Set a different time for each.
- While Record Message is activated, " ~ "" (the number of recorded messages for voice calls) and " ~ "" (the number of recorded messages for videophone calls) are displayed.

## Incoming calls when Record Message Setting is set to "ON"

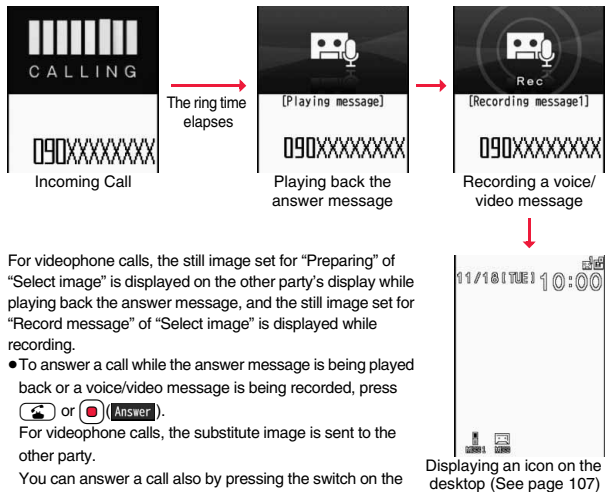

For videophone calls, the still image set for "Preparing" of "Select image" is displayed on the other party's display while playing back the answer message, and the still image set for "Record message" of "Select image" is displayed while recording.

- To answer a call while the answer message is being played back or a voice/video message is being recorded, press or (Answer).

For videophone calls, the substitute image is sent to the other party.

You can answer a call also by pressing the switch on the Flat-plug Earphone/Microphone with Switch (option).

Displaying an icon on the desktop (See page 107)

### Information

- Record Message does not work when is displayed.
- When Public Mode (Drive Mode) and Record Message are simultaneously activated, the former has priority and the latter does not work.
- The priority order of answer messages is as follows: "Setting for Phonebook entry" → "Group setting" → "Record message setting".
- If "Voice announce" selected as an answer message is deleted, the answer message will be set to "Japanese 1".

### Information

- When Voice Mail Service or Call Forwarding Service is set at the same time as Record Message, the priority depends on the ring time set for Voice Mail Service or Call Forwarding Service. To give Record Message priority, set the ring time for Record Message Setting shorter than that for Voice Mail Service or Call Forwarding Service. Even when you do this, Voice Mail Service or Call Forwarding Service works if there are already five record messages for voice calls and two record messages for videophone calls.
- You cannot receive a call from a third party while a voice/video message is being recorded. The third party will hear the busy tone.

### <Quick Record Message>

## Recording Voice/Video Messages when You cannot Answer the Call during Ringing

Even if a call comes in while Record Message is not activated, you can record the caller's voice/video message just for that incoming call.

### 1 During ringing (Memo) or

Manner Mode is also activated.

The caller will hear the answer message and then can leave you a voice/video message.

- Record Message does not work when five messages for voice calls and two messages for videophone calls have already been recorded. Only Manner Mode is set when you operate by pressing .
- When "Side keys guard" is set to "ON", you cannot activate Record Message or Manner Mode by pressing with the FOMA phone closed.

<Play/Erase Messages>  
<Play/Erase Videophone Messages>

MENU 5 5

## Playing Back/Erasing Record Messages/a Voice Memo/Videophone Record Messages/Movie Memos

### Play Back/Erase Record Messages/a Voice Memo

- 1 LifeKit ▶ Rec. msg/voice memo  
▶ Play/Erase msg.  
▶ Select a record message or voice memo.

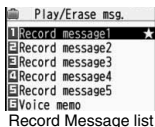

A beep sounds and playback starts.

- On the Record Message list, recorded items are indicated by "★".
- It is played back at the volume set for "Volume" (earpiece volume).
- When playback ends, a double-beep sounds and the message "Playing" is cleared from the display.
- The date and time the message/memo was recorded are displayed during playback. When a caller's phone number is provided, it is displayed. If the caller is stored in the Phonebook, his/her name is also displayed. However, the name is not displayed and the phone number only is displayed in the following cases:
  - When you play back a record message from the caller stored as secret data in Normal Mode
  - When you play back a record message for Number A in B Mode (or vice versa) while using 2in1
- If the caller's phone number is displayed during playback, you can make a voice call to that phone number by pressing . Press to make a videophone call.

#### To play back using

From the Stand-by display, press to play back the latest record message. When record messages are not recorded, a voice memo is played back.

#### To skip to next message

Each time you press during playback, messages are played back in the following order: the next new record message → the oldest record message → a voice memo.

#### To cancel playback midway

Press or .

### Play Back/Erase Videophone Record Messages/Movie Memos

- 1 LifeKit ▶ Rec. msg/voice memo  
▶ Play/Erase VP msg.  
▶ Select a videophone record message or movie memo.

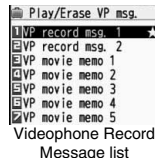

- On the Videophone Record Message list, recorded items are indicated by "★".
- It is played back at the same volume of the playback sound of i-motion movies.
- The date and time the message/memo was recorded are displayed during playback.

#### To play back using

From the Stand-by display, press and hold for at least one second to play back the latest videophone record message. When videophone record messages are not recorded, the latest movie memo is played back.

#### To cancel playback midway

Press or .

### Function Menu of the Record Message List/Videophone Record Message List

Function menu	Operation/Explanation
Play	You can play back the message.
Erase this	<p>▶ YES</p> <ul style="list-style-type: none"> <li>• You can erase the message/memo also by pressing  during playback.</li> </ul>

Function menu	Operation/Explanation
<b>Erase rec. msg.</b>	You can erase all record messages from the Record Message list, and can erase all videophone record messages from the Videophone Record Message list. ▶ YES
<b>Erase movie memo</b> [Videophone Record Message list only]	You can erase all movie memos. ▶ YES
<b>Erase all</b>	You can erase all record messages and a voice memo from the Record Message list, and can erase all videophone record messages and movie memos from the Videophone Record Message list. ▶ YES

## Using Chara-den

You can set up for sending a Chara-den image to the other party.



- See page 299 for Chara-den images.

### Set by Call

You can set a Chara-den image to be sent to the other party for making a videophone call.

#### 1 Chara-den display/Chara-den list ▶ (V. phone)

Enter the destination phone number and press  (V. phone) to make a videophone call.

- When the other party's phone number is stored in the Phonebook, you can retrieve it selecting from the Search Phonebook display by pressing .
- You can search for the phone number also from Received Calls by pressing  or from Redial by pressing .

### Information

- The priority order of substitute images to be sent to the other party is as follows: "Setting by call" → "Setting for Phonebook entry" → "Group setting" → "Select image".

## Substitute Image

You can set a Chara-den image for "Substitute image" of "Select image".







#### 1 Chara-den display/Chara-den list/Chara-den Recording display ▶ (FUNC) ▶ Substitute image

- From the Chara-den list, you can set it also by pressing  (Subst.).

## Chara-den Setup

You can perform settings for a Chara-den call. These settings are effective only for during a videophone call.

#### 1 During a Chara-den call ▶ (FUNC) ▶ Chara-den setup ▶ Do the following operations.

Item	Operation/Explanation
<b>Switch Chara-den</b>	▶ Select a Chara-den image. • If you switch Chara-den images, the action mode switches to Whole Action Mode.
<b>Action list</b>	You can display the list for actions that you can operate. • Highlight an action and press  (Select) to execute the action. Press  (Detail) to check the details of the action. • You can display the Action list also by pressing  .
<b>Change action</b>	You can switch the action mode between Whole Action Mode (  ) and Parts Action Mode (  ). • You can switch modes also by pressing  .
<b>SW substitute img.</b>	You can switch a substitute image to be sent to the other party to the still image set for "Pre-installed" of "Select image".
<b>SW org. subst. img.</b>	You can switch a substitute image to be sent to the other party to the still image set for "Original" of "Select image".

## Useful Functions for Videophone Calls

### Switch Images to be Sent

You can switch images to be sent to the other party from the substitute image to the image through your camera.

See page 299 for Chara-den.

#### 1 During a videophone call ▶

The image through your camera is sent to the other party.

“” is displayed while it is being sent.

- Press  (Subst.) again to switch from the image through your camera to the substitute image.

#### Information

- The priority order of substitute images to be sent to the other party is as follows: “Setting by call” → “Setting for Phonebook entry” → “Group setting” → “Select image”. Note that “Setting for Phonebook entry” and “Group setting” are disabled when a videophone call comes in without notifying the caller ID.
- Even when you make a videophone call sending a substitute image, you are charged for the digital communication.

### Switch Image Display Positions

You can switch the display locations of the received image and the sent image.

#### 1 During a videophone call, press (Change).

- Each time you press  (Change), the displays switch.

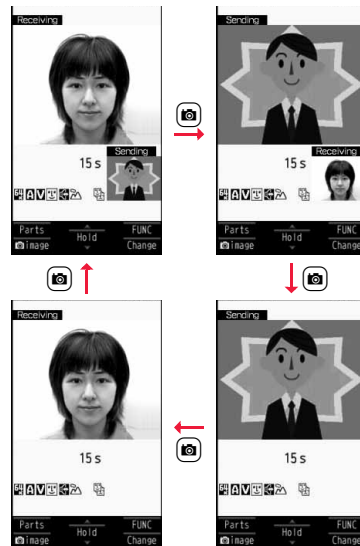

## Zoom

At videophone start-up	Wide
------------------------	------

You can adjust the magnification for the camera image to be sent to the other party. During a videophone call, the maximum magnification is about 6.8 times for the camera.

## 1 During a videophone call

▶ Use  to adjust the magnification.

- The former zoom setting returns when the videophone call ends.

### Function Menu during Videophone Call

Function menu	Operation/Explanation
CHG to voice call	See page 51.
Send DTMF tone/ DTMF tone OFF	<p>During a Chara-den call, you can switch to the DTMF Transmission Mode that enables you to enter the data from the numeric keys and to send DTMF (touch-tone signals). You can operate it only during a Chara-den call.</p> <ul style="list-style-type: none"> <li>• "Send DTMF tone" is displayed when the mode is not DTMF Transmission Mode and "DTMF tone OFF" is displayed in DTMF Transmission Mode.</li> <li>• In DTMF Transmission Mode, you cannot operate the action of Chara-den images.</li> <li>• The DTMF tone may not be received depending on the device of a receiving end.</li> </ul>
V.phone settings (Visual preference)	See page 74.
V.phone settings (Brightness)	<p>You can adjust the brightness of the camera image to be sent to other party to -3 (dark) through +3 (bright).</p> <p>▶ <b>Brightness</b> ▶ Select a brightness level.</p>
At videophone start-up	0

Function menu	Operation/Explanation
V.phone settings (White balance)	<p>You can adjust the colors of the camera image to be sent to the other party, to make the colors look more natural.</p> <p>▶ <b>White balance</b> ▶ Select an item.</p> <p><b>Fine weather</b> . . . . . For talking outdoors in fine weather</p> <p><b>Cloudy weather</b> . . . . . For talking in cloudy weather or in the shade</p> <p><b>Automatic</b> . . . . . For adjusting white balance automatically</p> <p><b>Light bulb</b> . . . . . For talking under incandescent light</p>
At videophone start-up	Automatic
V.phone settings (Color mode set)	<p>You can switch the color tone of the camera image to be sent to the other party.</p> <p>▶ <b>Color mode set</b> ▶ Select a color tone.</p>
At videophone start-up	Normal
V.phone settings (Night mode)	<p>You can lengthen the camera's exposure time to make the camera image to be sent clear in a dark place.</p> <p>▶ <b>Night mode</b> ▶ ON or OFF</p>
At videophone start-up	OFF
V.phone settings (Focus)	<p>You can set the focus for the camera during a videophone call.</p> <p>▶ <b>Focus</b> ▶ Close-up or Landscape</p>
At videophone start-up	Landscape
Chara-den setup	See page 71.
Backlight	<p>You can select whether to light the display constantly or light for about 15 seconds after an operation.</p> <p>▶ <b>Constant light or 15 seconds light</b></p>
LCD AI	See page 102.
Own number	You can display your phone number.
Key guide	You can display the guide of key operation during a videophone call.

## &lt;Hands-free with Videophone&gt;

## Setting Videophone Hands-free

You can set whether to switch to Hands-free automatically for when a videophone call starts.

- 1  ► Settings ► Videophone ► Hands-free w/ V. phone  
► ON or OFF

- See page 61 for the operation while Hands-free is activated and how to switch to Hands-free.

## &lt;Visual Preference&gt;

## Setting Image Quality for Videophone Calls

You can set the quality of both the received image and sent image on the display.

- 1  ► Settings ► Videophone ► Visual preference  
► Select an image quality.

- "Prefer motion spd" is effective for moving images. When there is little motion, the quality becomes better if you set to "Prefer img qual".
- If you operate from the Function menu during a videophone call, the setting is effective only for the current videophone call.

**Information**

- If the radio wave conditions weaken during a videophone call, the image may appear like a mosaic.

## &lt;Select Image&gt;

## Changing Image Displays for Videophone Calls

You can set an image to be sent to the other party.

- 1  ► Settings ► Videophone ► Select image  
► Select an item.

**On hold** . . . . . Sets an image for during answer-hold (On hold).

**Holding** . . . . . Sets an image for while a call is on hold (Holding).

**Substitute image**

. . . . . Sets a substitute image (still image or Chara-den) for when the camera is off.

**Record message**

. . . . . Sets an image while recording a record message.

**Preparing** . . . . . Sets an image for while playing back an answer message.

**Movie memo**



. . . . . Sets an image for while recording a movie memo.

## 2 Select an image.

**Pre-installed** . . . . . For sending a pre-installed still image to the other party.

**Original** . . . . . For sending an appropriate message with a still image stored using "Set display".

**Chara-den** . . . . . For sending a Chara-den image selected by "Substitute image" from the Function menu while a Chara-den image is displayed. (See page 71)  
(Displayed only when "Substitute image" has been selected in step 1.)

- Press  (Play) to play back a demo to check the still image or Chara-den image.
- To change the setting of "Original" or "Chara-den", press  (FUNC), select "Change setting", then select a still image or Chara-den image. If you have selected "Original", select a still image after selecting a folder. See "Set display" for settable still images.

**Information**



- Even if you delete the still image selected from "Original", that still image is displayed to the other party. To change, set by "Change setting" or "Set display".



## Set by Call

You can set an image to be sent to the other party for making a videophone call.

- 1 Enter a phone number  
OR  
bring up the detailed display of a Phonebook entry, redial item, dialed call record, or received call record.

- 2   ► Select image ► Chara-den  
► Select a Chara-den image.

• To cancel the setting by call, select "Release".

## <Voice Call Auto Redial>

### Redialing as a Voice Call when a Videophone Call cannot be Connected

If a videophone call cannot be connected, it will be automatically redialed as a voice call.

- 1  ► Settings ► Videophone ► Voice call auto redial  
► ON or OFF

#### Information

- The charges for calls once switched to voice calls are billed at the rates for the voice calls.
- Voice Call Auto Redial does not work when a videophone call cannot be connected such as when the line is busy or the other party's phone is in Public Mode (Drive Mode). However, Voice Call Auto Redial works when you make a videophone call to a phone that does not support the videophone function.

## <Notify Switchable Mode>

### Setting for Switching between a Voice Call and a Videophone Call

You can let the other party know that your FOMA phone can switch between a voice call and a videophone call.

This function is set to "Indication ON" at the time of contract. When "Notify switchable mode" is set to "Indication ON", the caller can switch between the videophone call and voice call.

- You cannot operate "Notify switchable mode" when you are out of the service area or radio waves do not reach, or during a call.

- 1  ► Settings ► Videophone ► Notify switchable mode  
► Do the following operations.

Item	Operation/Explanation
Indication ON	► YES ► OK
Indication OFF	► YES ► OK
Check indication	You can check the setting of the function.

## <Videophone while Packet>

### Selecting Response to Incoming Videophone Calls during i-mode

- 1  ► Settings ► Incoming call ► V-phone while packet  
► Select an item.

#### V-phone priority

... Shows the Videophone Call Receiving display. When you answer the videophone call, packet communication is disconnected.

#### Packet downld priority

... Rejects the videophone call and continues the communication.

#### V-phone answerphone

... Connects the incoming videophone call to the Voice Mail Service Center.

#### Call forwarding

... Forwards the incoming videophone call to the forwarding destination.

**Information**

- If you have not signed up for Voice Mail Service or Call Forwarding Service, "Packet downld priority" works even if you set to "V-phone answerphone" or "Call forwarding".

## Connecting FOMA Phone to External Devices to Use Videophone Function

You can operate your FOMA phone from an external device such as your personal computer for making or receiving videophone calls by connecting them using the FOMA USB Cable with Charge Function 01/02 (option).

To use this function, you need to install a videophone application program on a dedicated external device or personal computer, and further, you need to prepare equipment (commercial item) such as an earphone/microphone or USB compatible web camera.

- For operating environments for a videophone application program and how to set or operate it, refer to the instruction manual or other literature for an external device.
- You can use "ドコモテレビ電話ソフト (DOCOMO Videophone Software)" for the application program that supports this function.  
Download it from the DOCOMO Videophone Software web site. (For details such as operating environment for the personal computers, refer to the support web page.)

<http://videophonesoft.nttdocomo.co.jp/> (Japanese only)

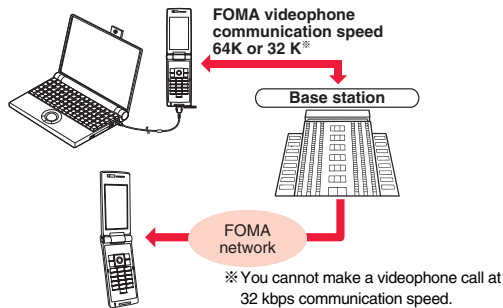
**Information**

- You cannot make a videophone call from the external device during a voice call.

**Information**

- When you have signed up for Call Waiting Service, an incoming videophone call from an external device during a voice call is recorded as a missed call in Received Calls. The same applies for an incoming voice call, videophone call, and 64K data communication during a videophone call from an external device.

# Phonebook

Phonebooks Available for FOMA Phone .....	78
Storing Phonebook Entries .....<Add to Phonebook>	78
Storing Displayed Phone Number/Mail Address in Phonebook .....	82
Setting Groups .....<Group Setting>	83
Dialing from Phonebooks ..... <Search Phonebook>	83
Editing Phonebook Entries .....<Edit Phonebook>	85
Deleting Phonebook Entries .....<Delete Data>	85
Checking Number of Phonebook Entries ..... <No. of Phonebook>	86
Making Full Use of Phonebooks .....	86
Making a Call with a Few Touches ..... <2-touch Dial>	88
Accessing Phonebook Entries by Voice ..... <Voice Dial>	88
Saving (Restoring/Updating) Phonebook to Data Storage Center ..... <Data Security Service>	90

## Phonebooks Available for FOMA Phone

You can use two types of Phonebook, namely the Phonebook in the FOMA phone itself, and the Phonebook on the UIM.

		FOMA phone	UIM		
Number of entries		1,000 entries	50 entries		
Contents of Phonebook	Basic item	Name (Reading)	<input type="radio"/>		
		Group	19 groups	10 groups	
		Phone number	4 phone numbers	1 phone number	
		Phone number icon	<input type="radio"/>	—	
		Mail address	3 mail addresses	1 mail address	
		Mail address icon	<input type="radio"/>	—	
		Address	<input type="radio"/>	—	
		Birthday	<input type="radio"/>	—	
		Memo	<input type="radio"/>	—	
		Image	100 images	—	
		Memory No.	From 000 to 999	—	
		Setting item	Ring tone	<input type="radio"/>	—
			Vibrator	<input type="radio"/>	—
Illumination	<input type="radio"/>		—		
Picture	<input type="radio"/>		—		
Chara-den	100 Chara-den images		—		
Mail ring tone	<input type="radio"/>		—		
Mail vibrator	<input type="radio"/>		—		
Mail illumination	<input type="radio"/>		—		
Answer message	<input type="radio"/>		—		
Restrictions	Restrict dialing		<input type="radio"/>	—	
	Call rejection	<input type="radio"/>	—		
	Call acceptance	<input type="radio"/>	—		
	Call forwarding	<input type="radio"/>	—		
	Voice mail	<input type="radio"/>	—		
Secret code	<input type="radio"/>	—			
Storage in Secret Mode or Secret Data Only	<input type="radio"/>	—			

		FOMA phone	UIM
Contents of Group	Name	<input type="radio"/>	<input type="radio"/>
	Ring tone	<input type="radio"/>	<input type="radio"/>
	Vibrator	<input type="radio"/>	<input type="radio"/>
	Illumination	<input type="radio"/>	<input type="radio"/>
	Picture	<input type="radio"/>	<input type="radio"/>
	Chara-den	<input type="radio"/>	<input type="radio"/>
	Mail ring tone	<input type="radio"/>	<input type="radio"/>
	Mail vibrator	<input type="radio"/>	<input type="radio"/>
	Mail illumination	<input type="radio"/>	<input type="radio"/>
	Answer message	<input type="radio"/>	<input type="radio"/>

: Can be stored. —: Cannot be stored.

- You can set your UIM into another FOMA phone and use the UIM Phonebook entries.

<Add to Phonebook>

## Storing Phonebook Entries

You can store Phonebook entries in the FOMA phone (Phone) or on the UIM.

-  (for at least one second) ► Phone or UIM  
The Edit Name display appears. Go to step 2 and enter a name.

- Do the following operations.

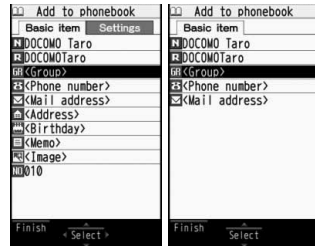

- You can press  to switch between the "Basic item" tab and "Settings" tab for the FOMA phone's Phonebook.











For the FOMA phone







For the UIM



Item	Operation/Explanation
<b>N</b> Name	<p>You can enter the name of the person or company in kanji, hiragana, katakana, alphabetic characters, or numerals.</p> <p>▶ <b>Enter a name.</b></p> <ul style="list-style-type: none"> <li>● For the FOMA phone, you can enter up to 16 full-pitch/32 half-pitch characters. You can enter pictographs and symbols as well.</li> <li>● For the UIM, you can enter up to 10 full-pitch characters/21 half-pitch alphanumeric characters. (Half-pitch katakana characters cannot be entered.) When the entry contains both full-pitch and half-pitch characters, you can store up to 10 characters from the beginning regardless of full-pitch or half-pitch characters.</li> </ul>
<b>R</b> Reading	<p>You can enter the reading in half-pitch katakana, alphabetic characters, or numerals.</p> <p>▶ <b>Enter a reading.</b></p> <ul style="list-style-type: none"> <li>● For the FOMA phone, you can enter up to 32 half-pitch characters. You can enter half-pitch symbols as well.</li> <li>● For the UIM, you can enter up to 12 full-pitch characters/25 half-pitch alphanumeric characters. (Half-pitch katakana characters cannot be entered.) When the entry contains both full-pitch and half-pitch characters, you can store up to 12 characters from the beginning regardless of full-pitch or half-pitch characters.</li> <li>● If the displayed reading is acceptable, you do not need to edit it. However, depending on the characters entered for names or entering method, they are not reflected in the reading.</li> <li>● If you enter “㇀ (reduced size)” or “㇁ (reduced size)” for a name, “㇂ (half-pitch, regular size)” (for the FOMA phone) and “㇃ (regular size)” (for the UIM) are displayed in the reading field.</li> </ul>
<b>Gr</b> Group	<p>In the FOMA phone, 19 groups are available. On the UIM, 10 groups are available.</p> <p>▶ <b>Select a group.</b></p> <ul style="list-style-type: none"> <li>● When the storage is completed with no group selected, the Phonebook entry is stored in “No setting”.</li> </ul>

Item	Operation/Explanation
<b>B</b> Phone number	<p>You can store up to four phone numbers per Phonebook entry in the FOMA phone. You can set an icon for each phone number to categorize mobile phone numbers, office phone numbers, and so on.</p> <p>You can store only one phone number per Phonebook entry on the UIM.</p> <p>▶ <b>Enter a phone number.</b></p> <ul style="list-style-type: none"> <li>● Enter from the city code for the phone numbers.</li> <li>● You can enter up to 26 digits. However, you can enter up to 20 digits for blue UIMs.</li> <li>● Press and hold  for at least one second to insert a pause (p) into the phone number you store. However, you cannot insert the pause (p) to the beginning of phone number or insert it consecutively. The pause (p) inserted to the end of phone number is not stored.</li> <li>● If you insert “*” in the middle of a phone number, you cannot make a call. However, the phone number is recorded in Redial or Dialed Calls.</li> <li>● You can store the phone number which includes “#” such as that for information service as well.</li> </ul> <p>▶ <b>Select an icon.</b></p> <ul style="list-style-type: none"> <li>● If you have stored a phone number in the FOMA phone, another “ &lt;Phone number&gt;” will appear in the Add-to-Phonebook display. To store another phone number, select “ &lt;Phone number&gt;”.</li> </ul>

Item	Operation/Explanation
 Mail address	<p>You can store up to three mail addresses per Phonebook entry in the FOMA phone. You can set an icon for each mail address to categorize mobile phone addresses, home addresses, and so on. You can store only one mail address per Phonebook entry on the UIM.</p> <p>▶ <b>Enter a mail address.</b></p> <ul style="list-style-type: none"> <li>• The mail address can consist of up to 50 half-pitch alphabets, numerals or symbol characters.</li> <li>• When the mail address is "phone number@docomo.ne.jp", store the phone number only.</li> <li>• For the FOMA phone, you can set a secret code as well. (See page 87)</li> </ul> <p>▶ <b>Select an icon.</b></p> <ul style="list-style-type: none"> <li>• If you have stored a mail address in the FOMA phone, another " &lt;Mail address&gt;" will appear in the Add-to-Phonebook display. To store another mail address, select " &lt;Mail address&gt;".</li> </ul>
 Address	<p>▶ <b>Enter a ZIP code</b> ▶ <b>Enter a postal address.</b></p> <ul style="list-style-type: none"> <li>• You can enter up to 7 digits for the zip code.</li> <li>• You can enter up to 50 full-pitch/100 half-pitch characters for the postal address. Further, you can enter pictographs as well.</li> <li>• You cannot enter "〒" or "—" (hyphen) in the zip code.</li> </ul>
 Birthday	<p>▶ <b>Enter a birthday</b> ▶ <b>ON or OFF</b></p> <ul style="list-style-type: none"> <li>• You can enter the birthday from January 1, 1800 through December 31, 2099.</li> <li>• When you set to "ON", the birthday is stored as an anniversary in the schedule of every year. "誕生日 (Birthday) (name)" is stored as the anniversary content.</li> <li>• Even if you delete the Phonebook entry, the anniversary stored in Schedule is not deleted.</li> </ul>
 Memo	<p>▶ <b>Enter a memo.</b></p> <ul style="list-style-type: none"> <li>• You can enter up to 100 full-pitch/200 half-pitch characters. Further, you can enter pictographs as well.</li> </ul>

Item	Operation/Explanation
 Image	<p>The stored still image is displayed when you call up the Phonebook entry.</p> <p>▶ <b>Select an item.</b></p> <p><b>Select image</b> . . . You can store a still image in Data Box.</p> <p><b>Shoot image</b> . . . You can store the shot still image. Perform step 2 through step 3 on page 135.</p> <ul style="list-style-type: none"> <li>• To release the stored still image, select "Release image".</li> <li>• The size of a still image you can store is Stand-by (240 x 427) or smaller and up to 300 Kbytes in JPEG format or GIF format.</li> <li>• If you store a still image larger than 72 x 54 dots, it is displayed shrunk on the detailed Phonebook display.</li> <li>• If you store a still image larger than 240 x 180 dots, it is displayed shrunk on the Call Receiving display.</li> <li>• When "Disp. PH-book image" is set to "ON", the stored still image is displayed for an incoming call. However, when another image is stored in the "Picture" field, that image is preferentially displayed for the incoming call.</li> </ul>
 Memory No.	<p>▶ <b>Enter a memory number.</b></p> <ul style="list-style-type: none"> <li>• Enter a three-digit number of "000" through "999".</li> <li>• The lowest empty memory number "010" through "999" is entered in advance. If "010" through "999" are all occupied, the lowest empty memory number from "000" through "009" is entered.</li> </ul>
 Ring tone	<p>You can set a ring tone for when a voice call or videophone call comes in from the person stored in the Phonebook.</p> <p>▶ <b>Select ring tone</b></p> <p>Go to step 2 on page 92.</p> <ul style="list-style-type: none"> <li>• To release the stored ring tone, select "Release ring tone".</li> </ul>

Item	Operation/Explanation
 <b>Vibrator</b>	You can set a vibration pattern for when a voice call or videophone call comes in from the person stored in the Phonebook. ▶ <b>Select vibrator</b> ▶ <b>Select a vibration pattern.</b> ● To release the stored vibrator, select "Release vibrator".
 <b>Illumination</b>	You can set an illumination pattern for when a voice call or videophone call comes in from the person stored in the Phonebook. ▶ <b>Select illumination</b> ▶ <b>Select a color.</b> ● To release the stored illumination, select "Release illumination".
 <b>Picture</b>	You can set an image to be displayed for when a call comes in from the person stored in the Phonebook. ▶ <b>Select picture</b> ▶ <b>Select a type of image</b> ▶ <b>Select a folder</b> ▶ <b>Select an image.</b> ● To release the stored image, select "Release picture".
 <b>Chara-den</b>	The stored Chara-den image is displayed as a substitute image for videophone calls with the person stored in the Phonebook. ▶ <b>Select Chara-den</b> ▶ <b>Select a Chara-den image.</b> ● To release the stored Chara-den image, select "Release Chara-den".
 <b>Mail ring tone</b>	You can set a ring tone for when a mail message comes in from the person stored in the Phonebook. ▶ <b>Select ring tone</b> Go to step 2 on page 92. ● To release the stored mail ring tone, select "Release ring tone".
 <b>Mail vibrator</b>	You can set a vibration pattern for when a mail message comes in from the person stored in the Phonebook. ▶ <b>Select vibrator</b> ▶ <b>Select a vibration pattern.</b> ● To release the stored mail vibrator, select "Release vibrator".

Item	Operation/Explanation
 <b>Mail illumination</b>	You can set an illumination pattern for when a mail message comes in from the person stored in the Phonebook. ▶ <b>Select illumination</b> ▶ <b>Select a color.</b> ● To release the stored mail illumination, select "Release illumination".
 <b>Answer message</b>	You can set an answer message for Record Message by Phonebook entry. ▶ <b>Select answer message</b> ▶ <b>Select an answer message.</b> ● To release the stored answer message, select "Release answer message".

### 3 Press (Finish).

- If you have not entered any name, "Finish" is not displayed and you cannot store the entry.

### Phonebook entries while editing

#### When the low battery alarm sounds

The Phonebook entry you are editing is saved automatically. The confirmation display appears asking whether to resume editing when you continue editing after charging the battery or when you operate step 1 on page 78 and select the storage location for the interrupted Phonebook entry after changing to a charged battery.

Recall. . . . You can resume editing the Phonebook entry.

New. . . . You can edit a new Phonebook entry. In this case, the interrupted data is retained. If you execute "Add to phonebook" after storing the new Phonebook entry, the confirmation display appears again.

- Only the most recently interrupted entry is retained.
- If you resume editing the data but then cancel editing without storing it, that data will be abandoned. Once you recall the data, be sure to store it.

#### If you receive a call or mail

You can respond to leaving the edited data as it is, thanks to the Multitask function.

To return to the Phonebook Edit display, press and hold **(MULTI)** for at least one second to switch the menu. You can return to the Phonebook Edit display also by ending the call or mail function.

## Storing Displayed Phone Number/Mail Address in Phonebook

You can store the displayed or selected phone number, mail address, and still image in the FOMA phone's or UIM's Phonebook.

Operation	Storable items
While a phone number is entered	Phone number
While a redial item, dialed call record, or received call record is displayed	Phone number
While Sent Address or Received Address is displayed	Phone number/Mail address
While a site or screen memo is displayed	Phone number/Mail address
While the text of Message R/F or mail is displayed	Phone number/Mail address
While the data scanned by Bar Code Reader or Text Reader is displayed	Phone number/Mail address
While a ToruCa file is displayed	Phone number/Mail address
While the Still Image list or a still image is displayed	Still image

### 1 Bring up/Select an item to be stored (FUNC)

#### ▶ Add to phonebook

- To store the address of the sender (or of another recipient of simultaneous mail) of the received mail or the destination address of the sent mail into the Phonebook, select "Store address".  
When the addresses of the sender and another recipient of simultaneous mail are found or the multiple destination addresses are found, the display for selecting an address appears. Use  to select the mail address or phone number you want to store.
- To store the results scanned by Text Reader in a Phonebook entry, select "Store phone No." or "Store mail add."
- To store a still image in the Phonebook, select "Phonebook" from "Set display".
- When "Add to phonebook" is displayed on the Scanned Code Result display for Bar Code Reader, select "Add to phonebook"; then other information in the scanned code besides the phone number or mail address is entered into each field.

### 2 Phone or UIM ▶ Select a storing method.

**New** . . . Go to step 2 on page 78.

**Add** . . . Adds data to the existing Phonebook entry. When storing data on the UIM, "Overwrite" is displayed.

### 3 Select a search method ▶ Search the Phonebook

#### ▶ Select a Phonebook entry to be stored (Select)

The phone number or mail address is entered automatically.

- See step 2 on page 78 to edit other items in the Phonebook entry.
- When you store into the FOMA phone's Phonebook, you can remain the original entry and store a new entry into a different location by changing the memory number.

### 4 (Finish) ▶ YES

- If you store the entry in the UIM Phonebook, select "Overwrite" to overwrite the original entry, or select "Add" to store it as a new entry.

#### Information



- The Phonebook entry does not store the information of "Notify caller ID" included in Redial/Dialed Calls. To set Caller ID Notification, add "186"/"184" to the phone number and store it.
- Characters that cannot be stored may be replaced by spaces or deleted, and then stored.
- You may not be able to store the information from some sites into the Phonebook.



## Setting Groups



You can utilize the Phonebook by sorting the entries by group such as “Company” or “Friend”, or by your interest such as “Baseball” or “Ceramic art”. You can set a ring tone, vibration pattern, or illumination by group.

### 1 Phonebook Group setting

- The groups on the UIM are indicated by “ (  ), select “Reset group”, and then select “YES”.

### 2 Highlight a group and press ( )

#### ▶ Select an item to be set ▶ Set the contents.

- When you select “ Group name”, enter a group name. You can store up to 10 full-pitch/21 half-pitch characters. However, you can store only up to 10 characters (regardless of full-pitch or half-pitch characters) when you enter both full-pitch and half-pitch characters for a UIM group name.
- See step 2 on page 78 for the operations of the other items. However, you cannot set for groups on the UIM.
- Select a stored group, or press  (  ) and select “Check setting” to check its settings. However, you cannot check the settings of the groups on the UIM.

### 3 Press ( ).





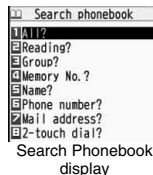

## Dialing from Phonebooks

You can retrieve stored Phonebook entries by eight search methods.

### 1 Do the following operations.

- The display for the same search method as the previous one appears once you have carried out a search. Press  to show the Search Phonebook display.



Item	Operation/Explanation
All?	You can bring up all Phonebook entries. <ul style="list-style-type: none"> <li>• The tabs appear on the top of the Phonebook list. (See page 84)</li> </ul>
Reading?	You can enter the reading of the other party's name from the first character and search. You do not need to enter the full reading. <ul style="list-style-type: none"> <li>▶ Enter a part of the reading </li> <li>• The tabs appear on the top of the Phonebook list. (See page 84)</li> </ul>
Group?	You can bring up Phonebook entries stored in the specified group. <ul style="list-style-type: none"> <li>▶ Select a group.</li> <li>• The tabs appear on the top of the Phonebook list. (See page 84)</li> <li>• If you press  (  ) on the Group list, the Function menu for “Group setting” is displayed.</li> </ul>
Memory No.? [FOMA phone only]	You can search for the entry by the memory number assigned when it was stored in the Phonebook. <ul style="list-style-type: none"> <li>▶ Enter the memory number.</li> <li>• Enter from “000” through “999” in three digits.</li> <li>• The tabs appear on the top of the Phonebook list. (See page 84)</li> <li>• From the Stand-by display, you can press  and then press  to display the Memory No. Dial display. From there you can make a voice call by entering the memory number of the phone number.</li> </ul>
Name?	You can enter the other party's name from the first character and search. You do not need to enter the full name. <ul style="list-style-type: none"> <li>▶ Enter a part of the name </li> </ul>

Item	Operation/Explanation
<b>Phone number?</b>	<p>You can enter a part of the other party's phone number and search. You can search for the entry even from the middle of phone number.</p> <p>▶ <b>Enter a part of the phone number</b> </p> <ul style="list-style-type: none"> <li>You can display the Phonebook list also by entering a part of the phone number from the Stand-by display or the "Talking" display, and pressing .</li> </ul>
<b>Mail address?</b>	<p>You can enter a part of the other party's mail address and search. You can search for the entry even from the middle of mail address.</p> <p>▶ <b>Enter a part of the mail address</b> </p>
<b>2-touch dial?</b> [FOMA phone only]	<p>You can bring up the list of Phonebook entries in memory number 000 through 009.</p> <ul style="list-style-type: none"> <li>Phonebook entries not yet stored or being set with secret are displayed as &lt;---&gt;.</li> </ul>

## 2 Select an entry or (Dial)

- When the entry contains multiple phone numbers, or when you searched by "Mail address?", press from the detailed display to select a phone number.
- You can make a videophone call by pressing (V. phone).

### Information

- In a search method other than "Group?" and "2-touch dial?", enter nothing and press ; then you can search all through the Phonebook.
- When no Phonebook entry is found that matches the condition you entered by "Reading?" or "Memory No.?", the entry that is the closest to the condition is displayed.

### Search order

The Phonebook entries are searched in the order of readings you entered for storing, as follows:

"Space at the beginning of the reading" → "Japanese syllabary (ア、イ、ウ、エ、オ...ン)" → "Alphabet (A, a, B, b, ...Z, z)" → "Numerals (0 through 9)" → "Symbols" → "No reading".  
For "All?" and "Reading?", searching is done in the following order:

"Japanese syllabary (ア、イ、ウ、エ、オ...ン)" → "Alphabet (A, a, B, b, ...Z, z)" → "Space at the beginning of the reading" → "Numerals (0 through 9)" → "Symbols" → "No reading".

※ The Memory No. Search searches in the order of the memory numbers.

## About Phonebook List

When you search from "All?", "Reading?", "Group?", or "Memory No.?", the tabs appear on the top of the Phonebook list. With "All?" and "Reading?", the entries are sorted by every column of reading, with "Memory No.?" by every 100 of the memory number, and with "Group?" by every group.

Press to display the Phonebook entries in the tab at left or right. However, when there are 12 or more Phonebook entries in a tab, pressing (Page ▲), (Page ▼), or brings up the previous or next page.

- After you search by "Reading?", you can move the cursor to the "ア" through "ワ", "英", and "他" tab by pressing each numeric key from the list. When you successively press the same numeric key, you can move the cursor within the same column.

<Example> Press to display the "ナ" tab. Each time you press , the cursor moves to the top of "ニ" "又" and so on.

- After you search by "Group?", you can move the cursor to the top of each column in the tab by pressing each numeric key from the list. When you successively press the same numeric key, you can move the cursor within the same column.

<Example> Press to move the cursor to the top of the "ナ" column. Each time you press , the cursor moves to the top of "ニ" "又" and so on.

- After you search by "Memory No.?", you can move the cursor to the "000-" to "900-" tab by pressing each numeric key from the list.

<Example> Press to move the cursor to the "500-" tab.

- You can make a voice call to the phone number stored for the name highlighted on the Phonebook list, by pressing . Also, press (V. phone) to make a videophone call. When multiple phone numbers are stored for the name, the one stored first will be dialed.

- appears for the Phonebook entries set to A by Phonebook 2in1 Setting, appears for the Phonebook entries set to B, and appears for the Phonebook entries set to common data. (Only in Dual Mode)



## About the detailed display

Use to highlight a tab, then the detailed contents are displayed.

- For the Phonebook entry stored on the UIM, "" is displayed on the memory number field.
- When Notify Caller ID is set to "Notify caller", "" appears, and when set to "Don't notify", "" appears.
- Under the still image, "" appears for the Phonebook entries set to A by Phonebook 2in1 Setting, "" appears for the Phonebook entries set to B, and "" appears for the Phonebook entries set to common data. (Only in Dual Mode)
- When a Phonebook entry contains the setting for Multi Number or Chaku-moji, the set contents are displayed in the Item list/Phone Number display.

Group (010) Memory No.  
 Reading DCCOMOTaro Still image  
 Name DCCOMO Taro Notify caller ID



Detailed Phonebook display (Item list)

### Item list

The first stored phone number, mail address, postal address, birthday, and memo are displayed.

### Phone number

### Mail address

- When you select the item, you can compose an i-mode mail message with that mail address entered into the address field.

### Personal information

- When you select a postal address, memo, or still image, the full display appears. Press (EXIT) or (CLR) to return to the former display.

### Settings

- When you select each item, a demo is played back. Press (STOP) or (CLR) to end the demo.

## <Edit Phonebook>

# Editing Phonebook Entries

## 1 Detailed Phonebook display **▶ Select an item to be edited ▶ Edit the contents.**

- See step 2 on page 78 for how to edit the Phonebook entry.
- Even if you edit the Phonebook entry in the FOMA phone (Phone), you can remain the original contents in the original location and store the edited contents in the different location by changing the memory number.

## 2 (Finish) **▶ YES**

- If you edited the UIM Phonebook entry, select "Overwrite" to overwrite the original contents, or "Add" to save the contents as a new entry.

## <Delete Data>

# Deleting Phonebook Entries

## Delete from the Detailed Phonebook Display



## 1 Detailed Phonebook display **▶ Delete data ▶ Select an item ▶ YES**

- You can delete an item highlighted by pressing from the detailed display or delete the Phonebook entry.

## Delete from the Phonebook List



## 1 Phonebook list **▶ Delete data ▶ Do the following operations.**

Item	Operation/Explanation
Delete this	<b>▶ YES</b>

Item	Operation/Explanation
Delete selected	<p>▶ Put a check mark for Phonebook entries to be deleted</p> <p>▶  (Finish) ▶ YES</p> <ul style="list-style-type: none"> <li>You can check or uncheck entries all at once by pressing  (FUNC) and selecting "Select all in tab/Select all/Release all in tab/Release all".</li> <li>Perform the same operation as that of "Delete all" when you have selected all Phonebook entries including secret ones.</li> </ul>
Delete all in tab	You can delete all the Phonebook entries for the displayed tab. ▶ YES
Delete all	You can delete all Phonebook entries including secret entries. ▶ Enter your Terminal Security Code ▶ YES ▶ YES

## &lt;No. of Phonebook&gt;

## Checking Number of Phonebook Entries



<b>1</b>	 ▶ Phonebook ▶ No. of phonebook
Phone	Phonebook . . . The number of Phonebook entries stored in the FOMA phone (Phone)
Secret . . . . .	The number of Phonebook entries stored as secret data (Displayed in Secret Mode or Secret Data Only)
Image . . . . .	The number of Phonebook entries in which still images are stored
Chara-den . . . .	The number of Phonebook entries in which Chara-den images are stored
Voice dial . . . .	The number of Phonebook entries set as voice dial entries
Rest . . . . .	 : The number of phone numbers that can still be stored
	 : The number of mail addresses that can still be stored
UIM	
Phonebook . . . .	The number of Phonebook entries stored on the UIM

## Information



- While you are using 2in1, the number of displayable Phonebook entries for each mode is displayed. (See page 399)



## Making Full Use of Phonebooks

## Function Menu of the Phonebook List

Function menu	Operation/Explanation
New	You can store a new Phonebook entry. Go to step 1 on page 78.
Sort	You can change the display order. ▶ Select a type of order. <ul style="list-style-type: none"> <li>You can sort Phonebook entries in reverse order by selecting "Ascending" or "Descending".</li> <li>You cannot sort on the Phonebook list with tabs displayed.</li> </ul>
Attach to mail	You can send an i-mode mail message with the Phonebook entry attached. Go to step 2 on page 174.
Send Ir data (Send phonebook)	See page 319.
Send Ir data (Send all phonebook)	See page 320.
 transmission (Send phonebook)	See page 321.
 transmission (Send all phonebook)	See page 322.
Copy to microSD	See page 307.
Connect to Center	See page 90.
Delete data	See page 85.
Character size	You can switch character sizes for the Phonebook and on the displays within "Phonebook settings", etc. (See "Phonebook" on page 111)
Set secret/Release secret	You can activate/deactivate Secret for the Phonebook entry. <ul style="list-style-type: none"> <li>If you select "Set secret" in ordinary mode (not in "Secret mode" or "Secret data only"), enter your Terminal Security Code.</li> </ul>

## Function Menu of the Detailed Phonebook Display

Function menu	Operation/Explanation
Notify caller ID	See page 45.
Prefix numbers	See page 60.
Int'l dial assist	See page 59.
2in1 dial	You can select a phone number to notify the other party in Dual Mode of 2in1. (See page 398)
Multi number	You can select a phone number to be notified to the other party. (See page 396)
Chaku-moji	See page 54.
Restrictions	See page 122.
Edit data	Go to step 1 of "Editing Phonebook Entries" on page 85.
Delete data	See page 85.
Add desktop icon	See page 109.
Compose message	You can compose an i-mode mail message to send to the mail address. Go to step 3 on page 174.
Compose SMS	You can compose an SMS message to send to the phone number set as the destination address. Go to step 3 on page 214.
Attach to mail	You can send an i-mode mail message with the Phonebook entry attached. Go to step 2 on page 174.
Send Ir data (Send phonebook)	See page 319.
Send Ir data (Send all phonebook)	See page 320.
 transmission (Send phonebook)	See page 321.
 transmission (Send all phonebook)	See page 322.

Function menu	Operation/Explanation
Copy to microSD	See page 307.
Connect to Center	See page 90.
Copy name	<ul style="list-style-type: none"> <li>You can paste the copied text to a mail message and others.</li> </ul>
Copy phone number/ Copy mail add./ Copy address/ Copy birthday/ Copy memo	<ul style="list-style-type: none"> <li>From the detailed display, press  to highlight an item to be copied. The items in the Function menu differ depending on the highlighted item.</li> <li>You can paste the copied text to a mail message and others.</li> </ul>
Secret code	<p>You need to add the recipient's secret code when sending i-mode mail to anyone who has registered a secret code. Once you set the secret code for the mail address in the Phonebook entry, it will be added automatically whenever you send mail to that address.</p> <p>▶ <b>Enter your Terminal Security Code ▶ Set code</b></p> <ul style="list-style-type: none"> <li>From the detailed display, press  to highlight a phone number or mail address to be set with a secret code.</li> <li>To check the secret code, select "Check code".</li> <li>To release the secret code, select "Release code".</li> </ul> <p>▶ <b>Enter a four-digit secret code ▶ YES</b></p> <ul style="list-style-type: none"> <li>In the Function menu, "Secret code" is indicated by "★", after it is set.</li> <li>Enter a four-digit number for secret code. You cannot set "0000".</li> </ul>
Character size	You can switch the character size for the Phonebook and on the displays within "Phonebook settings", etc. (See "Phonebook" on page 111)
Set secret/Release secret	See page 86.
Copy to UIM/ Copy from UIM	See page 370.

Function menu	Operation/Explanation
Select image	See page 75.
Sort phone number/ Sort mail address	<p>▶ <b>Select a phone number or mail address</b></p> <p>▶ Use  to change the order ▶  (Select)</p> <ul style="list-style-type: none"> <li>From the detailed display, press  to highlight an item to be sorted. The items in the Function menu differ depending on the highlighted item.</li> <li>To change the order in succession, repeat the above steps.</li> </ul> <p>▶  (Finish)</p>

### Information

#### <Secret code>

- You cannot set secret codes for UIM Phonebook entries.
- The secret code can be added only when the recipient's mail address is in the form of "phone number" or "phone number@docomo.ne.jp". It cannot be added to any other form of mail address.
- If you have stored the mail address as "phone number+secret code@docomo.ne.jp", you cannot reply to mail messages from the party of that mail address. After changing the mail address to "phone number@docomo.ne.jp", set the secret code.

### <2-touch Dial>

## Making a Call with a Few Touches

When the entry is stored in memory number "000" through "009" in the FOMA phone's Phonebook, you can dial the phone number just by pressing the lowest one digit of memory number and .

### 1 Numeric key () to ▶ or (Dial)

- You can make a videophone call by pressing (V phone).

### Information

- When the Phonebook entry contains multiple phone numbers, the first phone number will be dialed.

### Information

- When you set "Restrict dialing" to a Phonebook entry of memory number 000 through 009, set it to the first phone number in the Phonebook entry.
- When you store a Phonebook entry of memory number from 000 through 009 as secret data, make a call to that entry in Secret Mode or Secret Data Only.

### <Voice Dial>

## Accessing Phonebook Entries by Voice

Just vocalize the other party's voice dial name and then the Phonebook entry is accessed for making a call.

### Voice Dial Setting

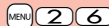

You can store up to 100 voice dial entries selecting from among the Phonebook entries stored in the FOMA phone (Phone).

### 1 ▶ Phonebook ▶ Phonebook settings ▶ Voice dial setting ▶ <New>

- You can edit the stored voice dial name by pressing (Edit). Go to step 3.
- To delete the stored voice dial entry, press (FUNC) and select "Delete" or "Delete all" and then select "YES".

### 2 Search the Phonebook ▶ Select a Phonebook entry.

- The display for search method you used last time appears.
- The "★" mark is added to the Phonebook entry stored in the Voice Dial list.

### 3 Enter a voice dial name.

- You can enter up to 22 half-pitch katakana characters.
- The reading (katakana only) of the Phonebook entry is displayed as the voice dial name. Correct the name to the easy-to-identify words.

### Information

- The voice dial name set by this function is effective only for calling up a voice dial entry. For the voice guidance function, the reading (name) stored in the Phonebook is read aloud.

## Information

- When multiple similar voice dial names are stored or when the voice dial name is short, the recognition rate lowers and a wrong voice dial entry (Phonebook entry) might be accessed. In this case, rename the existing voice dial name and store it.
- You cannot store “ボイスセットイ (Boisusettei)” as a voice dial name.

## Dial from Phonebook by Voice

By your voice, you can access the Phonebook entry you set in the Voice Dial list. When “Read aloud settings” is set to “ON” and “Voice dial” is checked, the operation is guided by the voice guidance.

### 1 (for at least one second)





▶ As soon as the voice recognition start tone sounds, vocalize the voice dial name.

Start vocalizing within four seconds after the voice recognition start tone sounds. Once the voice is recognized as a voice dial entry, the detected result is displayed.

- You cannot change the volume of the voice recognition start tone. The voice recognition start tone does not sound during Manner Mode.
- If you say the word “ボイス設定 (Boisusettei)”, the display of “Voice settings” appears. (See page 89)
- When “Auto voice dial” is set to “ON”, the display for Auto Voice Dial appears after the voice is recognized as a voice dial entry. Then about two seconds later, the FOMA phone automatically dials out.

### 2 Highlight a detected result and press or (Dial).

The first phone number in the selected Phonebook entry is dialed.

- You can bring up the detailed Phonebook display by pressing  (Detail).
- Highlight a phone number and press  or  (Dial) to make a voice call. Also, you can make a videophone call by pressing  (V phone).

## Information

- When you vocalize, keep your mouth away from the microphone about 10 cm. If your voice is too distant, it may be difficult to recognize your voice.
- Pronounce the voice dial name as clearly as possible.
- Before and after voice production, avoid making the sounds unrelated to the voice dial name such as clearing your throat, clicking your tongue, noisy breathing or other noise.
- Vocalize in quiet, noise-free locations.

## Information



- While vocalizing, do not put your fingers over the microphone, or press or brush the keys.

## To access a voice dial entry using the Flat-plug Earphone/Microphone with Switch

You need to set “Voice earphone dial” to “ON” and open the FOMA phone in advance.

1 Press and hold the switch of the Flat-plug Earphone/Microphone with Switch (option) for at least one second.

2 Perform the operations of “Dial from Phonebook by Voice” on page 89.

- You can make a call also by pressing the switch of the Flat-plug Earphone/Microphone with Switch instead of pressing  or .

## Voice Settings

1  ▶ Settings ▶ Other settings ▶ Voice settings  
▶ Do the following operations.

Item	Operation/Explanation
<b>Auto voice dial</b>	You can automatically make a call to the phone number accessed by voice. ▶ ON or OFF
<b>Voice earphone dial</b>	You can access the voice dial entries by using the Flat-plug Earphone/Microphone with Switch (option). ▶ ON or OFF
<b>Read aloud settings</b>	See page 354.
<b>Read aloud volume</b>	See page 355.
<b>Read aloud speed</b>	See page 355.
<b>Read aloud output</b>	See page 355.

Item	Operation/Explanation
Read aloud valid set.	See page 355.

### <Data Security Service>

## Saving (Restoring/Updating) Phonebook to Data Storage Center

You can save the Phonebook stored in your FOMA phone to the Data Storage Center. You can use the “電話帳お預かり (Data Security Service)” site of i-mode (  Menu → English → My Menu → 電話帳お預かり ) for restoration of the saved Phonebook and automatic update setting. Data Security Service is a pay service that is available on a subscription basis.



- You cannot use Data Security Service when you are out of the i-mode service area or when the power is off.
- For details on Data Security Service, refer to “Mobile Phone User’s Guide [i-mode] FOMA version”.

### 1 LifeKit ▶ Data Security Service ▶ Do the following operations.

Item	Operation/Explanation
Connect to Center	▶ Enter your Terminal Security Code ▶ YES
Sent/recv. PB data list	You can display the records of communication such as saving the Phonebook, mail messages, or images to the Data Storage Center. ▶ Select a record. • Select a communication completion time in the list to switch to the detailed display.
PB image sending	You can set whether to save images set for the Phonebook entries to the Data Storage Center. ▶ ON or OFF

## Downloading the Phonebook from the Data Storage Center to your FOMA phone

Note that if you delete Phonebook entries from your FOMA phone and save the Phonebook to the Data Storage Center, the Phonebook entries on the Data Storage Center are also deleted. When you download the Phonebook from the Data Storage Center to your FOMA phone, do the following operations to restore it.

1.  ▶  Menu ▶ English ▶ My Menu ▶ 電話帳お預かり (Data Security Service) ▶ お預かりセンター (Data Storage Center) ▶ Enter your i-mode password.
2. Select “ケータイへダウンロード (Download to mobile phone)” from the Phonebook on the Data Storage Center ▶ OK
  - About 15 seconds later, download starts. Wait for a while with the Stand-by display shown.

### Information

#### <Connect to Center>

- You cannot save the UIM Phonebook.
- When the Phonebook entries saved to the Data Storage Center exceeds the number of Phonebook entries storable in the FOMA phone’s Phonebook, the excess entries cannot be updated.

#### <Sent/recv. PB data list>

- Up to 30 records are saved. When more than 30 records are saved, the older records are overwritten.

#### <PB image sending>



- You cannot save the images whose output from FOMA phone is prohibited.

## Auto-update

On the site of the Data Storage Center, you can set so as to periodically update and save the Phonebook entries in your FOMA phone to the Data Storage Center.

- For details, refer to “Mobile Phone User’s Guide [i-mode] FOMA version”.

### Information

- The Phonebook is not automatically updated while another function is working at the time of Auto-update.
- If the Phonebook cannot be updated, the notification icon of “ ” (PB in Center updated) appears on the Stand-by display. Select “ ”, and the update display appears if Auto-update is set. If Auto-update is not set, the update display appears after you enter your Terminal Security Code.



# Sound/Screen/Light Settings

## Sound Settings

Changing Ring Tone. . . . . <Select Ring Tone>	92
Setting Play Start Position of Melody Set for Ring Tone or Alarm Tone. . . . . <Position to Play>	93
Informing You of an Incoming Call by Vibration . . . <Vibrator>	93
Using Recorded Sound as Ring Tone . . . <Voice Announce>	94
Changing Calling Tone. . . . . <Melody Call Setting>	94
Setting Keypad Sound . . . . . <Keypad Sound>	94
Setting Charging-start/end Tones. . . . . <Charge Sound>	95
Sounding Alarm when a Line is Likely to be Disconnected . . . . . <Quality Alarm>	95
Setting Ring Time for Mail and Messages R/F . . . . . <Mail/Message Ring Time>	95
Sounding Ring Tone from Earphone Only . . . . . <Headset Usage Setting>	95
Silencing Tones from FOMA Phone . . . . . <Manner Mode>	96
Selecting Manner Mode Type . . . . . <Manner Mode Set>	97

## Screen/Light Settings

Changing Displays . . . . . <Display Setting>	98
Displaying an Image Stored in Phonebook during Ringing . . . . . <Display Phonebook Image>	100
Displaying Arrival Information by Opening FOMA Phone . . . . . <Received Mail/Call at Open>	101
Setting Lights for Display and Keypad . . . . . <Backlight>	101
Adjusting Quality of Display Automatically . . . . . <LCD AI>	102
Making Display Hard to See from People Around . . . . . <View Blind>	102
Setting Quality of Display . . . . . <Image Quality>	102
Setting Color Combination for Display . . . . . <Color Theme Setting>	102
Setting Display of Main Menu . . . . . <Menu Icon Setting>	103
Using Kisekae Tool. . . . . <Kisekae Tool>	103
Using Feel * Mail . . . . . <Feel * Mail>	104
Setting Color of Call/Charging Indicator and Others . . . . . <Illumination>	105
Checking Missed Calls and New Mail by Tone and Call/Charging Indicator. . . . . <Info Notice Setting>	106
Using Icons on Desktop . . . . . <Desktop Icon>	107
Changing Character Font. . . . . <Font>	110
Changing Character Size . . . . . <Character Size>	111
Setting Clock Display . . . . .	112

<Select Ring Tone>

MENU 1 3

## Changing Ring Tone

You can set a ring tone for each incoming type.  
If you select an i-motion movie, the i-motion movie and sound are played back for incoming calls/messages. (Chaku-motion)

- The ring tone is the PCM sound source, chord of 128 tones, and ADPCM compliant.
- See "Add to Phonebook" for setting a ring tone by Phonebook entry, and see "Group Setting" for setting it by group.

### ■ Ring Tone List (pre-installed)

Display	Title	Name of Lyricist/Composer
Pattern 1	—	—
Pattern 2	—	—
Pattern 3	—	—
Pattern 4	—	—
Pattern 5	—	—
RING-Ta01	RING-Ta01	Tatsuki Hashimoto
RING-Ta02	RING-Ta02	Tatsuki Hashimoto
RING-Ta03	RING-Ta03	Tatsuki Hashimoto
RING-COM.A	RING-COM.A	COM.A
RING-Numb	RING-Numb	Numb
GENTLE FLOW	GENTLE FLOW	—
SOMEDAY MY PRINCE WI	SOMEDAY MY PRINCE WILL COME	Composer: CHURCHILL FRANK E
JAZZ	JAZZ	—
POLET SHMAJA	POLET SHMAJA	Composer: RIMSKIJ KORSAKOVICH NICOLAS ANDR
RHAPSODY ON A THEME	RHAPSODY ON A THEME OF PAGANINI OP 43	Composer: RACHMANINOFF SERGEI
SE-Ta01	SE-Ta01	Tatsuki Hashimoto
SE-Ta02	SE-Ta02	Tatsuki Hashimoto
SE-Ta03	SE-Ta03	Tatsuki Hashimoto
SE-Numb01	SE-Numb01	Numb
SE-Numb02	SE-Numb02	Numb

Display	Title	Name of Lyricist/Composer
SE-CubeJuice	SE-CubeJuice	CUBE JUICE
SE-COM.A	SE-COM.A	COM.A
Spy	—	—
Magical Stick	—	—
Twinkle	—	—
Smart Beep	—	—
Garden Terrace	—	—
Waterdrop	—	—
P706iu-imation*	P706iu-imation	Numb

\*i-motion movie

(Note) The names of lyricists and composers are described conforming to the JASRAC web page.

Whole part of long titles may not be displayed due to restriction of the display size.

## 1 Settings ▶ Sound ▶ Select ring tone ▶ Select an incoming type.

- Select an item and press  (Play) to check the contents actually played back or displayed.

## 2 Select ring tone ▶ Select a type of ring tone.

**Melody** ..... Sets a melody as a ring tone.

**MUSIC** ..... Sets a Chaku-uta Full<sup>®</sup> music file as a ring tone.

 **motion** ..... Sets an i-motion movie as a ring tone. (Chaku-motion/ Chaku-uta<sup>®</sup>)

**Voice announce** ... Sets the sound recorded by "Voice announce" as a ring tone. The setting is completed.

**OFF** ..... Sets a ring tone off. The setting is completed.

## 3 Select a folder ▶ Select a ring tone.

- If you select "MUSIC" in step 2, select "Fullsong ring tone" or "Point ring tone". (See page 346)
- See page 163 when you select "Search by i-mode".

### Information

- You can set the Call Receiving display by selecting "Phone" or "Videophone", and then by selecting "Select calling disp.". Go to step 2 on page 100.

## Information

- You can set the Mail Receiving display by selecting "Mail", "Chat mail", "MessageR" or "MessageF", and then by selecting "Select receiving disp.". Go to step 2 of "Set Stand-by Display" on page 98.
- The priority order of ring tones is as follows: "Read aloud settings" → "Setting for Phonebook entry" → "Group setting" → "Select ring tone". When a call comes in to the additional number, the ring tone specified by "Set as ring tone" of "Multi number" sounds.  
If a call comes in to Number B while using 2in1, the priority order of the ring tones is as follows: "Read aloud settings" → "Setting for Phonebook entry" → "Group setting" → "Ringtone set. for No. B" (see page 397).
- The ring tone or images set at purchase might be played back or displayed for incoming calls or messages, depending on the combination of this function and "Display setting".
- See "i-motion info" to check whether the i-motion movie can be set for a ring tone.
- When you set an i-motion movie containing video and sound for a mail ring tone, you can press **CLR** or others to stop the ring tone.
- When you set an i-motion movie containing video and sound for a ring tone (Chaku-motion), it is played back taking priority over "Display setting". However, if you set a voice-only i-motion movie for the ring tone, the image set by "Display setting" is displayed.
- When you set an i-motion movie containing video and sound for "Select calling disp.", the i-motion movie is played back taking priority over this function for incoming calls. However, if you set an i-motion movie containing only video for "Select calling disp.", the ring tone selected for this function is played back for incoming calls.
- When different types of mail — i-mode mail, SMS messages, chat mail, or Messages R/F — are received at the same time, the priority order of ring tone as follows: "Chat mail" → "i-mode mail/SMS" → "MessageR" → "MessageF". If you receive the same type of mail simultaneously, the ring tone corresponding to the mail you have received last works.
- For the melody downloaded from a site or attached to mail, or the melody prohibited to attach to mail or output from the FOMA phone, a playing part may be specified in advance. When the play-part-specified melody is set for the ring tone, only the specified part is played back.

## <Position to Play>

MENU 6 4

# Setting Play Start Position of Melody Set for Ring Tone or Alarm Tone

- 1 **MENU** ▶ **Settings** ▶ **Sound** ▶ **Position to play**  
▶ **Select a play start position.**

**Play all** . . . . . Plays back from the beginning of the melody.

**Play portion** . . . . . Plays back from the start position set for the melody.

## <Vibrator>

MENU 5 4

# Informing You of an Incoming Call by Vibration

You can set the vibrator to notify you of incoming calls and mail.

- 1 **MENU** ▶ **Settings** ▶ **Incoming call** ▶ **Vibrator**  
▶ **Select an incoming type** ▶ **Select a vibration pattern.**

**Pattern 1** . . . . . Alternates between vibration on (about 0.5 second) and off (about 0.5 second).

**Pattern 2** . . . . . Alternates between vibration on (about 1 second) and off (about 1 second).

**Pattern 3** . . . . . Alternates between vibration on (about 3 seconds) and off (about 1 second).

**Melody linkage** . . . . . Vibrates in time with the vibration pattern stored in the melody.

**OFF** . . . . . Does not vibrate.

- While you are selecting a pattern, the FOMA phone vibrates by the selected pattern for confirmation. However, it does not vibrate if you select "Melody linkage".

- The following icons are displayed on the Stand-by display while the vibrator is set:

: Vibrates for incoming voice calls or videophone calls.

: Vibrates for incoming mail, chat mail or Messages R/F.

: Vibrates for incoming voice calls or videophone calls, and vibrates for incoming mail, chat mail or Messages R/F.

**Information**

- The priority order of vibrators is as follows: "Setting for Phonebook entry" → "Group setting" → "Vibrator".
- Even when "Melody linkage" is set, the FOMA phone vibrates with "Pattern 2" if an i-motion movie or melody with no vibration pattern is set for the ring tone.
- Be careful not to leave the FOMA phone on a desk or similar places with the vibrator activated; when a call comes in, the FOMA phone might move and fall by vibration.

## &lt;Voice Announce&gt;







MENU 5 5

**Using Recorded Sound as Ring Tone**

You can set the sound you recorded with the FOMA phone for a ring tone (including a ring tone for Number B of 2in1), On hold tone/Holding tone, alarm for "Alarm", "Schedule", "ToDo", and "Book program", and an answer message for Record Message.

You can record only one item for about 15 seconds.

## 1 LifeKit ▶ Rec.msg/voice memo ▶ Voice announce ▶ Record

- To suspend recording midway, press  (Stop), , or . The contents recorded to that point are saved.
- The tone beeps about 5 seconds before the recording time (for about 15 seconds) ends. When recording ends, the tone beeps twice, and the former display returns.
- The recording is suspended when a call comes in, when an alarm for "Alarm", "Schedule", "ToDo", "Book program", or "Timer recording" sounds, or when you switch displays using Multitask during recording. (The contents recorded to that point are saved.)
- To play back the recorded sound, select "Play". To suspend playback midway, press  (Stop), , or .
- To erase the recorded sound, select "Erase", then select "YES".

## &lt;Melody Call Setting&gt;

**Changing Calling Tone**

Melody Call is a service that changes the ringing tone phone callers hear, to a melody you like.

For details, refer to "Mobile Phone User's Guide [Network Services]".

- Melody call is a pay service which is available on a subscription basis.

## 1 Settings ▶ Melody Call setting ▶ YES ▶ Operate following the instructions on the display.

**Information**

- Melody Call is not available for incoming videophone calls.
- When you select "YES" from the confirmation display asking whether to connect to the site, the line is connected to the i-mode site. You are not charged a packet communication fee for connecting to the site for settings, however, you are charged for connecting to the IP site, i-mode menu site, and free melody corner.



## &lt;Keypad Sound&gt;

MENU 3 0

**Setting Keypad Sound**

## 1 Settings ▶ Sound ▶ Keypad sound ▶ ON or OFF

**Information**

- You cannot change the volume for keypad sound.
- If you set this function to "OFF", the battery level tone (see page 42) and respective warning tones do not sound.
- The keypad does not make a sound when you press , during ringing, or during playback of a moving image or i-motion movie.
- When you press  with the FOMA phone closed, the FOMA phone works following "Info notice setting" on page 106.

<Charge Sound>

## Setting Charging-start/end Tones

The confirmation tone sounds twice when charging starts/ends.

- 1  ► Settings ► Other settings ► Battery ► Charge sound  
► ON or OFF

### Information

- You cannot change the volume for charge sound.
- The charging confirmation tone does not sound when a display other than the Stand-by display is shown or during Manner Mode or Public Mode (Drive Mode).

<Quality Alarm>

## Sounding Alarm when a Line is Likely to be Disconnected

When a call is likely to be disconnected midway due to bad radio wave conditions, an alarm sounds to inform you right before disconnection.

- 1  ► Settings ► Talk ► Quality alarm ► Select an alarm.
- No tone** . . . . . Does not sound.  
**High tone** . . . . High alarm sounds.  
**Low tone** . . . . . Low alarm sounds.

### Information

- You might be disconnected without hearing an alarm if radio wave conditions deteriorate suddenly.
- An alarm for "Quality alarm" sounds only from the earpiece during a videophone call.

<Mail/Message Ring Time>

## Setting Ring Time for Mail and Messages R/F

You can set the duration of the ring tone which sounds for incoming i-mode mail, SMS messages, Chat mail and Messages R/F.

- 1  ► Settings ► Sound ► Mail/Msg. ring time  
► Select a type of mail or message ► ON or OFF  
► Enter a ring time (seconds).

- Enter in two digits from "01" through "30".

<Headset Usage Setting>

## Sounding Ring Tone from Earphone Only

You can set where you make the ring tone and alarm sound from for when you connect the Flat-plug Earphone/Microphone with Switch (option).

- 1  ► Settings ► Sound ► Headset usage setting  
► Headset + speaker or Headset only

### Information

- Even when you set "Headset only", the ring tone sounds from both the earphone and speaker about 20 seconds after ringing starts. However, the tone does not sound from the speaker but sounds from the earphone only even after 20 seconds have elapsed if the tone sounds for the operations other than incoming calls, incoming mail, and alarm notification.
- Even when you set "Headset only", the tone sounds from the speaker when you do not connect the Flat-plug Earphone/Microphone with Switch or when you start shooting still or moving images.

**Information**

- In the following cases, the tone sounds from the earphone when the Flat-plug Earphone/Microphone with Switch is connected, and from the speakers when it is not connected, regardless of this setting:
  - While watching a 1Seg program
  - During playback of a video file
  - During playback of an i-motion movie
  - During playback of a PC movie
  - During playback of a melody
  - While an i-øppli program is running
  - During playback of a music file by MUSIC Player
  - During playback of a Music&Video Channel program
- Do not wind the cord of the Flat-plug Earphone/Microphone with Switch around the FOMA phone.
- The FOMA phone may pick up noise if you take the cord of the Flat-plug Earphone/Microphone with Switch close to the FOMA phone during a call.

## &lt;Manner Mode&gt;

**Silencing Tones from FOMA Phone**

**Just by pressing a key, you can set to silence tones such as a ring tone and keypad sound from the FOMA phone.**



**You can use “Manner mode set” to select Manner Mode functions from three types; “Manner mode”, “Super silent”, or “Original”.**

**While “Manner mode” or “Super silent” is activated, or while “Mic sensitiv.” is set to “Up” in “Original”, you can talk softly on the phone but your voice can still be heard clearly at the other end.**



**1 During standby/During a call**

▶ **[#] (for at least one second)**

Manner mode selected in “Manner mode set” is set.

- When the FOMA phone is closed, press and hold  for at least one second to activate Manner Mode.
- During Manner Mode, “” is displayed. The settings you selected for “Manner mode set” are also displayed.

: Indicates that “Vibrator” will work to notify events.

 /  / : Indicate that “Ring volume” has been set to “Silent”.

**Information**

- If you activate Manner Mode during a call or calling, the message to that effect appears.

**Information**

- The recording start tone sounds even in Manner Mode when you shoot still images or moving images.
  - In Manner Mode, if you try to play back a melody, the confirmation display appears asking whether to play it back. Select “YES” to play back the melody at the volume set for “Phone” of “Ring volume”. If the setting is “Silent” or “Step”, the volume is Level 2.
  - In Manner Mode, if you do the following operations, the confirmation display appears asking whether to play back voice or music.
    - Watching a 1Seg program
    - Playing back an i-motion movie
    - Playing back a video file
    - Playing back a PC movie
    - Playing back a music file by MUSIC Player
    - Playing back a Music&Video Channel program
- Select “YES” to play it back at the volume set for each player. When you change the volume level, it is played back at the set volume for the next time.
- When a Flat-plug Earphone/Microphone with Switch (option) is connected, the sound comes out of the earphone. The confirmation display asking whether to play back sound or music files during Manner Mode does not appear. Further, the playback tone does not sound from the speakers even if you unplug the Flat-plug Earphone/Microphone with Switch during playing back sound or music files by each player.

**To release Manner Mode**

Press and hold  for at least one second. During a call or calling, two beeps sound and the message that is released appears.

- When the FOMA phone is closed, press and hold  for at least one second to release Manner Mode.

**To activate Manner Mode during ringing**

Press  (Memo) or .

Manner Mode is activated and Record Message is simultaneously activated so that the caller can leave a voice/video message.

Even when “Record message setting” has not been set to “ON”, the Record Message function works.

Press  or  (Answer) to answer a call.

- When five messages for voice calls and two messages for videophone calls have already been recorded, Record Message does not work. Manner Mode specified by “Manner mode set” works.
- After you finish a call, Manner Mode is still activated.

## Selecting Manner Mode Type

You can select one of three types of operations for Manner Mode.

### ■ Operations during Manner Mode

	Manner Mode	Super Silent	Original
Record message	Set value of Record message		ON or OFF
Vibrator*1	ON		ON or OFF
Phone volume	Silent		Silent through Level 6 and step ①
Mail volume	Silent		Silent through Level 6 and step ②
Alarm volume*2	Silent		Silent through Level 6 and step
VM tone	ON	OFF	ON or OFF ③
Keypad sound	OFF		ON or OFF ④
Microphone sensitivity	Up		Normal or Up
Low voltage alarm tone (Low battery alarm)	OFF		ON or OFF When "LVA tone" is set to "ON", it works with the same set value as ①.*3
Confirmation tone for selecting ring tone	Silent		Works with the same set value as ① · ②.
On hold tone	Silent		Works with the same set value as ①.*4
Holding tone	Silent		Works with the same set value as ①.*5
ToruCa obtained tone and ToruCa failed-to-obtain tone	Silent		Works with the same set value as ①.
Confirmation tone for recording voice announce	ON	OFF	Works with the same set value as ③.
Battery level tone	Silent		Silent
Voice recognition start tone	Silent		Silent
Confirmation tone for checking missed calls and new mail	Silent		Works with the same set value as ①.*6
Playback tones of attached melody	Silent		Silent
Warning tones	Silent		Works with the same set value as ④.
Schedule alarm	Silent		Works with the same set value as ①.
ToDo alarm	Silent		Works with the same set value as ①.

	Manner Mode	Super Silent	Original
Alarm for Book program	Silent		Works with the same set value as ①.
Alarm for Timer recording	Silent		Works with the same set value as ①.*7
Start tones for shooting still and moving images	Level 4		Level 4
Confirmation tone for selecting shutter sound	OFF		Works with the same set value as ①.*4
Switching to Hands-free by "Hands-free w/ V. phone"	OFF		OFF
Read aloud volume	Silent		Works with the same set value as "Read aloud volume" on page 355.
Effect tones of Flash movies	Silent		Silent

\*1 Vibrator works for the following tones:

Ring tones and alarm tones for "Alarm", "Schedule", "ToDo", "Book program" and "Timer recording"

The vibration pattern is the same as the setting you set on page 93. However, if the setting you set on page 93 is "OFF", "Pattern 2" applies.

Confirmation tone for checking missed calls and new mail

The FOMA phone vibrates for about 1 second when you have missed calls or new mail messages and vibrates for about 0.2 second when you have no missed calls and new mail messages.

\*2 When "Prefer manner mode" on page 357 is set to "OFF", the tone sounds at the volume set for Alarm.

\*3 The tone sounds at Level 1 when ① is "Silent".

\*4 The tone sounds at Level 2 when ① is "Step".



\*5 The tone sounds at Level 1 when ① is not "Silent".

\*6 The tone sounds at Level 6 when ① is not "Silent".

\*7 The tone does not sound when ① is "Step".

You can select from among standard “Manner mode” to inform you of incoming calls or mail by the vibrator, “Super silent” to erase sounds including confirmation tones from the earpiece, or “Original” to customize operations.

- 1  Settings ▶ Incoming call ▶ Manner mode set
  - ▶ Manner mode, Super silent or Original
  - ▶ Do the following operations.

Item	Operation/Explanation
Record msg.	<ul style="list-style-type: none"> <li>▶ ON or OFF</li> <li>• Even if you select “ON”, the ring time is fixed to about 13 seconds and cannot be changed when “Record message setting” on page 68 is set to “OFF”.</li> <li>• See page 68 for Record Message Setting.</li> </ul>
Vibrator	<p>You can set the FOMA phone to vibrate for incoming calls and mail.</p> <ul style="list-style-type: none"> <li>▶ ON or OFF</li> <li>• See page 93 for Vibrator.</li> </ul>
Phone vol.	<p>You can adjust the ring volume for incoming voice calls and videophone calls.</p> <ul style="list-style-type: none"> <li>▶ Use  to adjust the volume.</li> <li>• See page 65 for Ring Volume.</li> </ul>
Mail vol.	<p>You can adjust the ring volume for i-mode mail, SMS messages, and Messages R/F.</p> <ul style="list-style-type: none"> <li>▶ Use  to adjust the volume.</li> <li>• See page 65 for Ring Volume.</li> </ul>
Alarm vol.	<ul style="list-style-type: none"> <li>▶ Use  to adjust the volume.</li> <li>• See page 356 for Alarm.</li> </ul>
VM tone	<p>You can set the FOMA phone to sound a confirmation tone when a record message is played back, a voice memo is recorded or played back, and a movie memo is recorded.</p> <ul style="list-style-type: none"> <li>▶ ON or OFF</li> </ul>
Keypad sound	<ul style="list-style-type: none"> <li>▶ ON or OFF</li> <li>• See page 94 for Keypad Sound.</li> </ul>
Mic sensitiv.	▶ Normal or Up

Item	Operation/Explanation
LVA tone	<ul style="list-style-type: none"> <li>▶ ON or OFF</li> <li>• See page 42 for LVA Tone (low battery alarm).</li> </ul>

- 2 Press  (Finish).

<Display Setting>

MENU 5 6

## Changing Displays

### Set Stand-by Display

You can set an image for the Stand-by display. You can set also i-motion movies shot by the FOMA phone or downloaded from sites for the Stand-by display.

- 1  Settings ▶ Display ▶ Display setting
  - ▶ Stand-by display ▶ Select a type of image.

- If you select “Calendar/schedule”, select a display format, and then select “BG image ON” or “BG image OFF”. If you select “BG image OFF”, the setting is completed.
- If you select “ applli display”, select an i-applli program. The setting is completed.

- 2 Select a folder ▶ Select an image.

- On the Stand-by display, the image smaller than the display is shown in equivalent dimensions or enlarged to fit to the display size, depending on the image size.
- See page 163 when you select “Search by i-mode”.



### When Calendar/schedule is set

You can display schedule events of the day (up to 10) or calendar in the set format on the Stand-by display. You can check the schedule events or calendar and can set schedule events (see page 359) with ease.

You can access the schedule events or calendar by pressing

from the Stand-by display. Highlight an item to be operated and press (Select).

• When you select a schedule event, you can confirm the previous or next schedule events by pressing .

You can display the detailed schedule display by pressing (Select).

• When you select the calendar, you can display the previous or next calendar by pressing . If "Calendar (1 month)", "Calendar (2 months)", or "Calendar (3 months)" is set, you can display the previous or next calendar also by pressing .

You can set a schedule event by pressing (Select).



For  
"Calendar+schedule"

### When an original animation or animation GIF is set

It is played back when you display the Stand-by display, press from the Stand-by display, or open the FOMA phone. The first frame is displayed as the Stand-by display.

### When a Flash movie is set

It is played back when you display the Stand-by display, press from the Stand-by display, or open the FOMA phone. The image stopped such as by your first operation is displayed as the Stand-by display.

### When an i-motion movie is set

It is played back when you display the Stand-by display, press from the Stand-by display, or open the FOMA phone. The first frame is displayed as the Stand-by display.

• Press or during playback to adjust the sound.

Press , , , , (CLR), or to end the playback.

• If you play back an i-motion movie during Manner Mode, the sound is not played back.

### Not to display icons on the Stand-by display

Press from the Stand-by display.

Calendar, schedule events, status icons, notification icons, and desktop icons are cleared. Press again to show the icons and others.

When a Flash movie is set for the Stand-by display, however, the following operations are performed:

- When you press during playback of a Flash movie, the playback pauses. Press again to clear the icons and others.

#### Information

- The schedule list shows the today's schedule events whose start time has not come, and the today's schedule events set as "Whole day". "Holiday" and "Anniversary" are not displayed.
- Some i-motion movies might not be correctly displayed.
- You cannot set a still image larger than the Stand-by (240 x 427) size or in excess of 300 Kbytes for the Stand-by display.
- You cannot set some images or i-motion movies for the Stand-by display.
- The sound of Flash movies cannot be played back.

### Set the Wake-up Display

You can set an image or message to be displayed for when the power is turned on.

**1** **Settings** ▶ **Display** ▶ **Display setting**  
▶ **Wake-up display** ▶ **Select a type of image.**

- If you select "Message", enter a message. You can enter up to 50 full-pitch/100 half-pitch characters.
- If you select "My picture" or "i-motion", go to step 2 of "Set Stand-by Display" on page 98.
- See page 163 when you select "Search by i-mode".

#### Information

- You cannot set some images or i-motion movies for the Wake-up display.
- The sound of Flash movies cannot be played back.

## Set Displays for Dialing/Calling and Others

You can set an image for the Dialing/Call Receiving display, Mail Sending/Mail Receiving display, and Checking display.

### 1 Settings ▶ Display ▶ Display setting ▶ Select a type of display.

- When "Incoming call" or "Videophone incoming" is selected, select "Select calling disp."
- When "Mail receiving" is selected, select "Select receiving disp." and go to step 2 of "Set Stand-by Display" on page 98.
- If you select "Dialing", "Videophone dialing", "Mail sending", "Check new message", or "Mail/msg. rcpt result", go to step 2 of "Set Stand-by Display" on page 98.
- Select "Incoming call", "Videophone incoming" or "Mail receiving" and press  to check the contents actually displayed or played back.

### 2 Select a type of image.

Go to step 2 of "Set Stand-by Display" on page 98.

#### Information

- When you select "Incoming call", "Videophone incoming", or "Mail receiving", select "Select ring tone" to set the ring tone. Go to step 2 on page 92.
- The priority order of displays for call receiving is as follows: "Setting for Phonebook entry" → "Group setting" → "Disp. PH-book image" → "Display setting". However, when "Incoming call" or "Videophone incoming" of "Read aloud settings" is set to "ON", the default image is displayed.  
The same order applies if a call comes in to Number B while using 2in1. However, when you set an i-motion movie containing video and sound for a ring tone (Chaku-motion) by "Ringtone set. for No. B", it is played back as Chaku-motion, taking priority over this function.
- When you set an i-motion movie containing video and sound for a ring tone (Chaku-motion), it is played back for incoming calls, taking priority over this function. However, if you set a voice-only i-motion movie, the image set by this function is displayed.
- When you set an i-motion movie containing video and sound for "Select calling disp.", the i-motion movie is played back taking priority over "Select ring tone" of "Incoming call" for incoming calls. However, if you set an i-motion movie containing only video for "Select calling disp.", the ring tone selected for "Select ring tone" of "Incoming call" is played back.



#### Information

- The images or ring tone set at purchase might be displayed or played back for incoming calls or messages, depending on the combination of this function and "Select ring tone".
- You cannot set some images for "Display setting".
- The sound of Flash movies is not played back.

## Set Battery Icon and Antenna Icon

You can set the icons for battery level and radio wave reception level that appear on the display.

### 1 Settings ▶ Display ▶ Display setting ▶ Battery icon or Antenna icon ▶ Select a pattern.

- You cannot change icons such as  or .

## Show Icons in Color/Monochrome

### 1 Settings ▶ Display ▶ Display setting ▶ Icon color ▶ Color or Monochrome

- You cannot change the battery icon and antenna icon.

### <Display Phonebook Image>

## Displaying an Image Stored in Phonebook during Ringing

If the caller ID notified by the caller matches the phone number stored in the Phonebook, the still image stored in the Phonebook is displayed.

### 1 Settings ▶ Incoming call ▶ Disp. PH-book image ▶ ON or OFF

#### Information

- The priority order of displays for call receiving is as follows: "Picture for Phonebook entry" → "Picture for group" → "Image for Phonebook entry" → "Display setting". However, when "Incoming call" or "Videophone incoming" of "Read aloud settings" is set to "ON", the default image is displayed.

<Received Mail/Call at Open>

## Displaying Arrival Information by Opening FOMA Phone

When you have a missed call, new mail message, new chat mail message, or new Message R/F, the detailed Missed Call display/Inbox list/Chat Mail display/Message R/F list is displayed at opening the FOMA phone.

1  Settings ▶ Display ▶ Recv. mail/call at open  
▶ ON or OFF

### Information

- When a call comes in while you are using Simple Menu, the detailed Received Call display appears.
- When newly received messages and missed calls are found, the detailed Missed Call display appears.
- When a new mail message, chat mail, Message R/F are simultaneously received, the messages are displayed in the order of the chat mail message, i-mode message, Message R, and Message F.

<Backlight>



## Setting Lights for Display and Keypad

1  Settings ▶ Display ▶ Backlight  
▶ Do the following operations.

Item	Operation/Explanation
Lighting	<p>You can set whether to light the backlight in ordinary time.</p> <p>▶ ON or OFF</p> <ul style="list-style-type: none"><li>• If you set to "OFF",  appears on the Stand-by display.</li></ul> <p>Also, you can set whether to activate Power Saver Mode for the display.</p> <p>▶ ON or OFF ▶ Enter a light time (seconds).</p> <ul style="list-style-type: none"><li>• Enter from "015" through "999" in three digits.</li></ul>

Item	Operation/Explanation
Charging	<p>▶ Standard or Constant light</p> <p><b>Standard</b> . . . . . Lights during charging in the same setting as it lights in ordinary time.</p> <p><b>Constant light</b> . . . . Always lights during battery charge.</p>
Area	<p>You can set the range the backlight lights in.</p> <p>▶ LCD+Keys or LCD</p>
Brightness	<p>You can adjust the brightness of the backlight for the display to Level 1 (dark) through Level 5 (bright).</p> <p>▶ Select a brightness level.</p> <ul style="list-style-type: none"><li>• When "Auto setting" is set, the backlight set by "Area" is automatically adjusted according to the ambient brightness that has been detected by the light sensor.</li></ul>
Soft light	<p>You can set whether to light the backlight softly for the display.</p> <p>▶ ON or OFF</p> <ul style="list-style-type: none"><li>• Even if you set to "OFF", the backlight might light softly for some functions.</li></ul>

### To switch the backlight on/off by pressing one key

Press and hold  for at least one second.

- While an i-appli program is running, you cannot switch Backlight on/off by pressing and holding  for at least one second.

### Information

- When "Lighting" is set to "ON", the backlight stays lit while a call is coming in and the area specified by "Area" lights for about 15 seconds when you turn on the power, touch the keys, or open the FOMA phone. The backlight stays lit while the camera is activated or a moving image/i-motion movie is played back. When "OFF" is set, it does not light. However, it stays lit during recording of a moving image regardless of the "Lighting" setting.
- See page 73 for Backlight during a videophone call.
- See page 264 for Backlight for while watching a 1Seg program.
- If the power is supplied from external power sources such as an AC adapter (option), the setting for "Charging" applies, regardless of the on/off setting of the backlight for "Lighting".
- When you display the text of i-mode mail or Messages R/F, the lighting time varies according to the length of the text.

**Information**

- If "Power saver mode" is set to "ON" and the specified time elapses without doing any operations from the Stand-by display or the voice call talking display, the FOMA phone switches to Power Saver Mode and the display goes off.
- When an image other than still image is set for the Stand-by display, the Stand-by display shifts to Power Saver Mode after the image is played back and a standby time elapses.
- The FOMA phone does not switch to Power Saver Mode during data communication or charging, or while the i-appli Stand-by display is running.
- The display appears when you operate the FOMA phone, receive a call, or receive i-Channel tickers. However, the receiving display does not appear when you receive a call in Public Mode (Drive Mode).

**<LCD AI>****Adjusting Quality of Display Automatically**

You can set whether to automatically adjust the brightness of the display backlight and to compensate the image quality according to that brightness during playback of i-motion movies, PC movies, Music&Video Channel programs, or video files, during a videophone call, or while watching a 1Seg program.

**1** **MENU** ▶ Settings ▶ Display ▶ LCD AI ▶ ON or OFF

- If you operate the setting from the Function menu during a videophone call or watching a 1Seg program, the setting is effective only for the current videophone call or 1Seg program.

**Information**

- If you set to "ON", the brightness is adjusted within the level specified for "Brightness" of "Backlight". The brightness is adjusted also while you are selecting a menu item.
- This function is disabled during Play Background.

**<View Blind>****Making Display Hard to See from People Around**

You can adjust the contrast of the display so that it is hardly viewed from a slanted angle.

**1** **MENU** ▶ Settings ▶ Display ▶ View blind ▶ ON or OFF  
▶ Select a contrast.

- You can set the contrast to Level 1 through Level 3. It is the most difficult to view in Level 3.

**To switch View Blind on/off by pressing one key**

Press and hold **8** for at least one second.

- While an i-appli program is running or PDF file is displayed, you cannot switch View Blind on/off by pressing and holding **8** for at least one second.

**<Image Quality>****Setting Quality of Display****1** **MENU** ▶ Settings ▶ Display ▶ Image quality ▶ Select an item.

**Normal** . . . . .Normal image quality

**Vivid** . . . . .Vivid image quality

**Dynamic** . . . . .Dynamic image quality in which motion is emphasized

**<Color Theme Setting>****Setting Color Combination for Display**

You can set the display color pattern of characters, backgrounds, and so on.

**1** **MENU** ▶ Settings ▶ Display ▶ Color theme setting  
▶ Select a color theme.

- While a color theme is selected, the selected color theme appears on the display for confirmation.

### Information

- You cannot change the color for icons and images displayed in multiple colors, the DOCOMO pictographs, and the Internet web pages (sites) supporting i-mode.

### <Menu Icon Setting>

MENU 5 7



## Setting Display of Main Menu

You can change the icons and the background images of Main Menu.

1   (FUNC) ► Menu icon setting ► Select a pattern.

2 When you select “Customize” in step 1, select a menu icon or background image to be changed  
► Select a folder ► Select an image.

Repeat step 2 and set menu icons and a background image.

- While selecting a menu icon or background image, press  (Play) to confirm the currently set image.
- To reset the menu icon and background image set to “Customize” to “スタンダード (Standard)” in the “Pre-installed” folder, press  (FUNC) and select “Reset” or “All reset”, then select “YES”.
- See page 163 when you select “Search by i-mode”.

### Information

- The image you can customize is a JPEG or GIF image whose size is Stand-by (240 x 427) or smaller and up to 300 Kbytes. Perform “Change size” or “Trim away” for other images.
- When a customized image is deleted, “スタンダード (Standard)” in the “Pre-installed” folder returns.
- When Personal Data Lock is activated while “Customize” is set, the default image is displayed.
- When you set “Customize”, the main menu icons do not switch even if you switch “Select language”.

### <Kisekai Tool>

## Using Kisekai Tool

You can use Kisekai Tool to change the ring tone, Stand-by display, menu icons and others at a time.

- See page 161 for details on how to download Kisekai Tool files.

### ■ Items that can be set with Kisekai Tool

- Select ring tone
- Display setting
- Color theme setting
- Menu icon setting
- Illumination
- Illumination in talk
- Side key illumination
- Tone

- Items that can be set differ depending on the Kisekai Tool file.

- The setting change of phone/videophone ring tones, mail ring tone, and Stand-by display is applied only to the A Mode of 2in1. The other changes are applied to the all modes of 2in1.

1  ► Settings ► Kisekai

► Highlight a Kisekai Tool file and press  (Set)

► YES

- “★” is added to the Kisekai Tool file collectively set at the moment.
- Depending on the selected Kisekai Tool file, the confirmation display might appear asking whether to change the character size. When you select “NO”, you might not be able to set the Kisekai Tool file correctly.

### Information



- For the functions set by Kisekai Tool, each setting display is shown with “Follow Kisekai Tool” highlighted. You can separately change each setting, however, if you want to reset to the setting by Kisekai Tool, you need to perform collective settings again. You cannot select “Follow Kisekai Tool”.
- If you use Kisekai Tool to change the design of the Menu display, some menu configurations change according to the usage frequency depending on the type of the menu. Further, some menu numbers that are assigned to the menu items do not apply.  
In that case, you cannot operate as described in this manual, so you are advised to show Main Menu of “Normal” by “Disp. default MENU”, or reset Main Menu by “Reset menu screen”.

## Function Menu of Main Menu

Function menu	Operation/Explanation
Menu icon setting	See page 103.
Change launcher	You can manually replace the items on Main Menu. ▶ Select a destination to save to ▶ YES
Disp. default MENU	You can temporarily show Main Menu of "Normal". ● Once you close Main Menu of "Normal", the currently set Main Menu returns.
Reset	See page 104.

## Reset Changed Design

You can reset the items changed by Kisekae Tool.

-  ▶  (FUNC) ▶ **Reset**  
 ▶ Enter your Terminal Security Code ▶ Select an item.
- Reset disp./sound** . . . . Resets all of "■"Items that can be set with Kisekae Tool" to the default.
- Reset menu screen** . . . Resets Main Menu to the default. You can reset also by pressing and holding (CLR) for at least one second from the Stand-by display and selecting "YES".
- Reset menu log** . . . . . Resets the operation records of Main Menu to the default.

### Information

- Even if you perform "Reset disp./sound" or "Reset menu screen", you cannot reset "Character size".
- Even if you execute "Reset menu screen", the Main Menu items you have manually replaced by "Change launcher" are not reset.

## <Feel \* Mail>

## Using Feel \* Mail

The Feel \* Mail reproduces the atmosphere of a mail message by actions of 45 types of animated characters. Once you activate Feel \* Mail, a Feel \* Mail image is played back after you receive an i-mode mail/SMS message.

- To end the playback, press  or (CLR).



-  ▶ **Settings** ▶ **Feel \* Mail**  
 ▶ Do the following operations.

Item	Operation/Explanation
<b>Disp./play new one</b>	A Feel * Mail image is played back after you receive an i-mode mail/SMS message. ▶ <b>ON or OFF</b> ● When this function is set to "OFF", a Feel * Mail icon does not appear on the Received Address list/Detailed Received Address display, the Inbox list, and the detailed Received Mail display even while "Disp./play in history" is set to "ON".
<b>Disp./play in history</b>	A Feel * Mail icon appears on the Received Address list/Detailed Received Address display, the Inbox list, or the detailed Received Mail display. ▶ <b>ON or OFF</b>

## Setting Color of Call/Charging Indicator and Others

- 1  Settings ▶ Illumination  
▶ Do the following operations.

Item	Operation/Explanation
All illum. setting	You can set all illumination items at one time. ▶ <b>Select a pattern.</b>
Illumination	See page 106.
Illumination in talk	You can set the flickering color of the Call/Charging indicator for during a call. ▶ <b>Select a color.</b> <ul style="list-style-type: none"><li>• The Call/Charging indicator flickers for confirmation while you are selecting.</li><li>• It flickers in the same color while Record Message is working, during answer-hold (On Hold), or while a call is on hold (Holding).</li></ul>
Miss/unread illum.	The Call/Charging indicator flickers for missed calls, new mail messages, new chat mail messages, or new Messages R/F at about 5-second interval for about 3 hours. ▶ <b>ON or OFF</b> <ul style="list-style-type: none"><li>• It does not flicker in Public Mode (Drive Mode), during Lock All, and during Omakase Lock. Flickering does not resume even after Public Mode (Drive Mode) or each lock is released.</li></ul>
Music&Video ch illum.	The Call/Charging indicator flickers when obtaining Music&Video Channel programs is completed at about 5-second interval for about 30 minutes. ▶ <b>ON or OFF</b>
Illum. when folded	The Call/Charging indicator lights when the FOMA phone is closed. ▶ <b>ON or OFF</b>



Item	Operation/Explanation
Hourly illumination	You can be notified of the specified time (every hour at 0 minutes) by the tone and light of the Call/Charging indicator. ▶ <b>Select a pattern.</b> <b>OFF</b> . . . . . The Call/Charging indicator does not light. <b>Pattern 1</b> . . . . . A fixed tone sounds and the Call/Charging indicator lights in the fixed color. <b>Pattern 2</b> . . . . . The tone and light of the Call/Charging indicator change by month or time. <ul style="list-style-type: none"><li>• "Hourly illumination" does not work while a display other than the Stand-by display is shown, or Lock All or Omakase Lock is activated.</li><li>• Time tone sounds at the volume set for "Phone" of "Ring volume". If "Step" is set, it sounds at Level 2.</li></ul>
MUSIC illumination	The Call/Charging indicator flickers for about 15 seconds when you start playback by MUSIC Player. ▶ <b>ON or OFF</b>
IC card illumination	The Call/Charging indicator lights/flickers when you place the FOMA phone over an IC card scanning device or during iC communication. ▶ <b>ON or OFF</b> <ul style="list-style-type: none"><li>• It does not light/flicker during IC Card Lock.</li></ul>
Side key illumination	You can set the lighting color of the Call/Charging indicator for when you press  with the FOMA phone closed. ▶ <b>Select a color.</b> <ul style="list-style-type: none"><li>• The Call/Charging indicator lights for confirmation while you are selecting.</li><li>• The lighting duration differs depending on the illumination.</li></ul>
Check settings	You can check the setting contents for "Illumination", "Illumination in talk", "Hourly illumination" and "Side key illumination".

## Illumination

MENU 8 9

You can set a flickering color of the Call/Charging indicator for each incoming type.

1  ► Settings ► Illumination ► Illumination  
► Do the following operations.

Item	Operation/Explanation
Set color	<p>► Select an incoming type ► Select a color.</p> <ul style="list-style-type: none"><li>• To make the indicator light in colors "Color 1" to "Color 12" in order, select "Gradation".</li><li>• The Call/Charging indicator lights for confirmation while you are selecting.</li></ul>
Set pattern	<p>You can set the flickering pattern of the Illumination.</p> <p>► Select a pattern.</p> <p><b>Standard</b> . . . . . Flickers in the same pattern repeatedly.</p> <p><b>Melody linkage</b> . . . . . Flickers with the ring tone.</p>
Color setting (Edit color name)	<p>► Edit color name ► Select a color ► Enter a name.</p> <ul style="list-style-type: none"><li>• You can edit "Color 1" through "Color 12" only.</li><li>• You can enter up to 10 full-pitch/20 half-pitch characters.</li></ul>
Color setting (Adjust color tone)	<p>► Adjust color tone ► Select a color ► Adjust the color tone.</p> <ul style="list-style-type: none"><li>• You can adjust the color tone of "Color 1" through "Color 12" only.</li><li>• Use  to select a color and use  to change the color tone.</li></ul>

### Information

#### <Set color>

• The priority order of illumination is; "Setting for Phonebook entry" → "Group setting" → "Set color".

#### <Set pattern>

- The Call/Charging indicator flickers in specified pattern for each illumination when "Set color" is set to other than "Color 1" through "Color 12" and "Gradation".
- The Call/Charging indicator flickers by "Standard" when an i-motion movie or melody with no flickering pattern is set for the ring tone.

## <Info Notice Setting>

MENU 6 5

# Checking Missed Calls and New Mail by Tone and Call/Charging Indicator

When the FOMA phone is closed, you can press  to check for missed calls, new mail, new chat mail, new Messages R/F, record messages, and voice mail messages. To use this function, you need to set "Side keys guard" to "OFF" in advance.

1  ► Settings ► Incoming call ► Info notice setting  
► Select an item.

**ON**\* . . . Notifies you whether there are missed calls, new mail, new chat mail, or new Messages R/F by the electronic sound and flickering of the Call/Charging indicator.

**OFF** . . . . Turns off the information notice.

\* When "Select language" is set to "日本語 (Japanese)", you can select "電子音 (electronic sound)" or "ボイス (voice)". With "ボイス (voice)", Japanese electronic voice and flickering of the Call/Charging indicator notify you of new chat mail, new mail, missed calls, record messages and voice mail messages in this order.

If you press  while the FOMA phone is closed

**When you have a missed call, new mail, new chat mail, or new Message R/F**

(When the "Missed call" icon, "New mail" icon, "Chat mail", or "Message R/F" icon is displayed on the Stand-by display.)

If "Info notice setting" is set to "ON", a double-beep tone sounds and the Call/Charging indicator lights for about five seconds.

If "Info notice setting" is set to "ボイス (voice)" in Japanese display, a beep tone sounds and a voice message announces that you have new mail, a missed call, and so on, and the Call/Charging indicator lights for about five seconds.

• When "Info notice setting" is set to "ボイス (voice)" in Japanese display, and a new Message R/F comes in, a voice message announces that you have new mail.

• If you press  again while the voice is being played back, you can stop it.

**When you have no missed calls, new mail, new chat mail, or new Message R/F**

If "Info notice setting" is set to "ON", or "ボイス (voice)" in Japanese display, a triple-beep tone sounds, and the Call/Charging indicator flickers for about five seconds.

Even when "Info notice setting" is set to "ボイス (voice)" in Japanese display, the notice is not made by voice.



## Information

- You cannot check for the mail messages held at the i-mode Center by this function.
- The confirmation function might not work depending on the function being activated.
- The sound volume for electronic sound cannot be changed.
- “ボイス (voice)” sounds at the volume set for “Phone” of “Ring volume”. If “Step” is set, the sound volume is Level 2.
- The missed call, new mail, and new chat mail are informed by both the Call/Charging indicator and the vibrator unless “Phone” of “Vibrator” has been set to “OFF”.
- The vibrator notifies the information as follows:
  - Vibrates for about 1 second when you have a missed call, new mail, or new chat mail message.
  - Vibrates for about 0.2 second when you have no missed calls, new mail, or new chat mail message.
- If you open the FOMA phone during notification, it stops.

## <Desktop Icon>

# Using Icons on Desktop

















## ■ Operation when a status icon is selected

	<b>Vibrator</b> Shows the display for Vibrator. (See page 93)
	<b>Ring volume</b> Shows the display for Ring Volume. (See page 65)
	<b>Manner mode</b> Shows the display Manner Mode Set. (See page 98)
	<b>Public Mode (Drive Mode)</b> Shows the display for releasing Public Mode (Drive Mode). (See page 66)
	<b>Notice call cost</b> Shows the display for Notice Call Cost. (See page 368)

	<b>Alarm</b> Shows the list of Alarm, Schedule, ToDo, Book Program, or Timer Recording. (See page 259, page 260, page 356, page 359 or page 363)
	<b>A Music&amp;Video Channel program is booked</b> Shows the Music&Video Channel display. (See page 332)
	<b>Backlight</b> Shows the display for Backlight. (See page 101)
	<b>Side keys guard</b> Shows the display for Side Key Guard. (See page 120)
	<b>USB mode setting</b> Shows the display for USB Mode Setting. (See page 313)
	<b>Voice mail</b> Shows the display for Voice Mail. (See page 387)
	<b>Voice mail for Number B</b> Shows the display for Voice Mail. (See page 387)
	<b>Record message</b> Shows the display for Rec. Msg/Voice Memo. (See page 68, page 70, page 94 and page 366)
	<b>Videophone record message</b> Shows the display for Rec. Msg/Voice Memo. (See page 68, page 70, page 94 and page 366)















## ■ Operation when a notification icon is selected













	<b>Missed call</b> Shows the Missed Call list. (See page 53)
	<b>Missed call to Number B of 2in1</b> Shows the Missed Call list. (See page 53)
	<b>Record message</b> Shows the Record Message list. (See page 70)
	<b>Videophone record message</b> Shows the Videophone Record Message list. (See page 70)
	<b>New i-mode mail or SMS</b> Shows the Inbox list. (See page 190)
	<b>New chat mail</b> Starts Chat Mail. (See page 212)

	<b>New Message R/F</b> Shows the Message R/F list. (See page 207)
	<b>i-oppli did not start automatically</b> Shows the i-oppli Auto Start Info. (See page 235)
	<b>A ToruCa file is obtained from a scanning device</b> Shows the ToruCa File list. (See page 243)
	<b>A security error occurred on the i-oppli Stand-by display</b> Shows the Security Error History. (See page 223)
	<b>Success in downloading a Music&amp;Video Channel program</b> Activates Music&Video Channel. (See page 332)
	<b>Failure in downloading a Music&amp;Video Channel program</b> Activates Music&Video Channel. (See page 333)
	<b>Missed alarm</b> Shows the contents of the alarm that could not be notified. (See page 359)
	<b>Missed program</b> Shows the contents of the booked program that could not be notified. (See page 262)
	<b>Timer recording was completed</b> Shows the contents and results of the timer recording. (See page 262)
	<b>Messages are held at the Voice Mail Center</b> Shows the Voice Mail display. (See page 386)
	<b>The Phonebook could not be updated by Data Security Service</b> Shows the update display for Data Security Service. (See page 90)
	<b>Software Update is needed</b> Starts Software Update. (See page 468)
	<b>Software Update was executed</b> Shows the Update Completion display or the reason for not completing. (See page 467)
	<b>Software rewriting is possible</b> Shows the rewriting confirmation display. (See page 466)
	<b>Pattern data was updated automatically</b> Shows the updated result. (See page 472)

	<b>The FOMA phone and a personal computer are connected by the FOMA USB Cable with Charge Function 01/02 (option)</b> Shows the display for USB Mode Setting. (See page 313)
--	---

■ Operation when a desktop icon is selected

	<b>Phone number</b> Shows the dialing display with the phone number entered. (See page 48)
	<b>URL of site</b> Shows the site of that URL. (See page 150)
	<b>URL for Full Browser</b> Shows the site of that URL by Full Browser. (See page 266)
	<b>Sender's/Destination address of i-mode mail</b> Shows the Message Composition display with the mail address entered. (See page 174)
	<b>Sender's/Destination address of SMS</b> Shows the SMS Composition display with the mail address entered. (See page 214)
	<b>i-oppli**</b> Starts the i-oppli program. (See page 221)
	<b>Picture**</b> Shows it on the Picture viewer. (See page 282)
	<b>i-motion movie**</b> Plays it back by the i-motion player. (See page 290)
	<b>Video file**</b> Plays it back by the Video player. (See page 296)
	<b>Chara-den image**</b> Plays it back by the Chara-den player. (See page 299)
	<b>Melody**</b> Plays it back by the Melody player. (See page 301)
	<b>PDF file**</b> Shows it on the PDF viewer. (See page 323)
	<b>ToruCa file**</b> Shows it on the ToruCa viewer. (See page 241)
	<b>Private menu</b> Shows the Private menu. (See page 364)

	<b>Alarm</b> Shows the list of Alarm. (See page 356)
	<b>Schedule</b> Shows the Calendar display. (See page 360)
	<b>ToDo</b> Shows the ToDo list. (See page 363)
	<b>Text memo</b> Shows the list of Text Memo. (See page 369)
	<b>Calculator</b> Shows the calculator. (See page 369)
	<b>使いかたナビ (Guide)</b> Shows the display for 使いかたナビ (Guide). (See page 36)
	<b>Bar code reader</b> Shows the Bar Code Reader menu. (See page 144)
	<b>Receive Ir data</b> Shows the Ir Data Receiving display. (See page 319 and page 320)
	<b>Camera</b> Shows the Camera menu. (See page 135 and page 137)
	<b>Text reader</b> Shows the Text Reader menu. (See page 146)
	<b>MUSIC Player</b> Starts MUSIC Player. (See page 340)
	<b>Music&amp;Video Channel</b> Shows the Music&Video Channel display. (See page 332)

※ When the original data is deleted or overwritten, the desktop icon is disabled.

## Paste Icons to Desktop

You can paste up to 15 desktop icons of such as phone numbers, mail addresses, etc.

### 1 The display for an item to be pasted ▶ (FUNC)

#### ▶ Add desktop icon ▶ YES

- When the addresses of the sender and another recipient of simultaneous mail are found or the multiple destination addresses are found, select a mail address or phone number to be pasted.

### Information

- You may not be able to paste the URL to the desktop depending on the site.
- You can store the title for URL of up to 16 full-pitch/32 half-pitch characters. When the number of characters for the title exceeds that much, the characters in excess are deleted. If no title exists for a site, up to 22 half-pitch characters of the URL excluding "http://" or "https://" is displayed.
- Some files and data might not be pasted to the desktop.

## Proceed to Respective Functions from Icons on Desktop

### 1 Press .



### 2 Use to highlight an icon, and press (Select).

- Up to five "Desktop icons" are displayed. If there are six or more icons, "◀" and "▶" are displayed.
- A "Notification icon" is deleted when each function is executed. To delete all "Notification icons", press and hold **CLR** for at least one second from the display in step 1.



**Information**

- When the notification icon of "Messages are held at the Voice Mail Center" (  ) appears while you are overseas, you cannot operate the Voice Mail function from the notification icon. Follow the steps of "Operate Voice Mail Service at the Country You Stay" on page 419.

**Check Details of Desktop Icon**

MENU 6 3

**1** MENU ▶ Settings ▶ Display ▶ Desktop icon





The list of desktop icons pasted to the desktop is displayed.



Desktop icon list

**2** Select the icon whose details are to be displayed.**Function Menu of the Desktop Icon List**

- You can bring up the Function menu also by pressing  (FUNC), while highlighting a desktop icon from the Stand-by display.

Function menu	Operation/Explanation
Add to desktop	▶ Put a check mark for the function to be added ▶  (Finish)
Edit title	▶ Enter a title. • You can enter up to 16 full-pitch/32 half-pitch characters. However, the number of characters for the title displayed when you highlight the icon is up to 11 full-pitch/ 22 half-pitch characters from the beginning of the title.
Sort	▶ Select a desktop icon ▶ Use  to change the order ▶  (Select) • To change the order in succession, repeat the above steps. ▶  (Finish) ▶ YES
Reset desktop	The desktop icons are reset to the default. ▶ YES

Function menu	Operation/Explanation
Delete this	▶ YES
Delete all	▶ YES

&lt;Font&gt;

MENU 6 6

**Changing Character Font****1** MENU ▶ Settings ▶ Display ▶ Font ▶ Font 1, Font 2 or Font 3**Information**

- Some characters are displayed in "Font 1" regardless of the setting of this function.
- You cannot change the font of a phone number entry or clock display.

**Set Character Font of Phone Numbers**

You can set the font of phone numbers displayed on the following displays:

- Dialing/Call Receiving display · Dialed Calls/Received Calls/Detailed Redial display
- Detailed Sent Chaku-moji message
- When you use 2in1, the setting here applies to Number A. To specify for Number B, operate "Set call/receive No. (Disp. call/receive No.)\*" of "2in1 setting".

**1** MENU ▶ Settings ▶ Incoming call ▶ Disp. call/receive No. ▶ Pattern1 or Pattern2

# Changing Character Size

1 Settings ▶ Display ▶ Character size  
▶ Do the following operations.

Item	Operation/Explanation
<b>Enlarge font display</b>	<p>You can set all the items of "Character size" at a time.</p> <p>▶ <b>Large, Standard, or Small</b></p> <ul style="list-style-type: none"> <li>The confirmation display might appear asking whether to change the character size of the menu as well. If you select "YES", the menu icons are set to "Enlarge menu" when you have set to "Large", and they return to the default when you have set "Standard" or "Small".</li> <li>When "Large" is set, "Mail", "i-mode", "Character input (Character size)" and "Character input (Candid. disp. size)" are set to "Extra large".</li> <li>When "Small" is set, "Settings", "Phonebook", "Dialed/recv. calls" and "Character input (Character size)" are set to "Standard".</li> <li>If you select "YES" from the confirmation display asking whether to enlarge the font when switching to Simple Menu, "Large" is set.</li> </ul>
<b>Mail</b>	<p>You can set the character size for the detailed mail display, detailed Message R/F display and on the displays within "Mail settings".</p> <p>▶ <b>Extra large, Large, Standard, or Small</b></p> <ul style="list-style-type: none"> <li>While a sent or received mail message is displayed, press  , or press  to select "Display" and then select "Character size".</li> <li>You cannot change the character size of Deco-mail pictograms.</li> <li>While the detailed mail display is displayed, you can change character size also by pressing and holding  for at least one second.</li> </ul>
<b>i-mode</b>	<p>You can set the character size for sites and "i-mode settings".</p> <p>▶ <b>Extra large, Large, Standard, or Small</b></p>

Item	Operation/Explanation
<b>i-Channel ticker</b>	<p>You can set the character size for the tickers of i-Channel.</p> <p>▶ <b>Large, Standard, or Small</b></p> <ul style="list-style-type: none"> <li>You can check the ticker by pressing  (Play). Press  to return to the former display.</li> </ul>
<b>Setting menu</b>	<p>You can set the character size for "Settings" on Main Menu.</p> <p>▶ <b>Large or Standard</b></p>
<b>Phonebook</b>	<p>You can set the character size for the Phonebook and "Phonebook settings".</p> <p>▶ <b>Large or Standard</b></p> <ul style="list-style-type: none"> <li>You can set also by  ▶ Phonebook ▶ Phonebook settings ▶ Character size ▶ Phonebook.</li> </ul>
<b>Dialed/recv. calls</b>	<p>You can set the character size for the Redial/Dialed Call/Received Call/Sent Address/Received Address list.</p> <p>▶ <b>Large or Standard</b></p> <ul style="list-style-type: none"> <li>You can set also by  ▶ Phonebook ▶ Phonebook settings ▶ Character size ▶ Dialed/recv. calls.</li> </ul>
<b>Character input (Character size)</b>	<p>You can set the character size for the character entry display, Message Composition display, or SMS Composition display.</p> <p>▶ <b>Character size ▶ Extra large, Large or Standard</b></p>
<b>Character input (Candid. disp. size)</b>	<p>You can set the character size for the conversion candidate list shown below the Character Entry (Edit) display.</p> <p>▶ <b>Chandid. disp. size ▶ Extra large, Large, Standard, or Small</b></p>

■ When the character size is set, the display appears as shown below:

<For Detailed Received Mail display>

Extra large	Large	Standard	Small

**Information**

- Depending on the function, characters might not be displayed in the set size.
- When "Extra large" or "Large" is set, some item names displayed for each operating procedure differ from the ones displayed for when "Standard" or "Small" is set.

## Setting Clock Display



You can set whether to display the clock on the Stand-by display and can set its display pattern.

- 1 ► Settings ► Display ► Display setting ► Clock  
 ► Do the following operations.

Item	Operation/Explanation
Clock display	<p>► Big, Small, or OFF</p> <ul style="list-style-type: none"> <li>• You cannot change the clock size of World Time Watch and the sub clock.</li> </ul>
Day of week	<p>When "Select language" is set to "日本語 (Japanese)", you can select "日本語 (Japanese)" or "英語 (English)".</p> <ul style="list-style-type: none"> <li>• If you set to "英語 (English)", also region names of World Time Watch are displayed in English.</li> </ul>
Position	► Select a pattern.
Color	► Black or White

**Information****<Position>**

- Even if you set any of "Pattern 3" through "Pattern 13", the clock is displayed in "Pattern 2" in the following cases:
  - When you set Calendar for the Stand-by display
  - When World Time Watch or the sub clock is displayed under the clock on the Stand-by display<sup>\*\*</sup>
  - When a carrier name is displayed on the Stand-by display by "Operator name display"
  - When "time zone" of "Set time" is not set to "GMT +9".<sup>\*\*</sup>
  - During Lock All
  - During Omakase Lock
- <sup>\*\*</sup> Even if you set to "Pattern 1", the clock is displayed in "Pattern 2".
- If you set "Pattern 1", the settings of "Clock display" and "Day of week" are invalid.

# Security Settings

## Passwords

Passwords	114
Changing Terminal Security Code . . . <Change Security Code>	115
Setting PIN Code . . . . . <UIM Setting>	115
Releasing PIN Lock . . . . .	116

## Restricting Operations or Functions

Locking your Phone to Prevent Use by Others . . . <Lock All>	116
Using Omakase Lock . . . . . <Omakase Lock>	117
Using Self Mode . . . . . <Self Mode>	117
Locking Functions Regarding Personal Information . . . . . <Personal Data Lock>	118
Setting Lock by Closing the FOMA Phone . . . . . <Timer Lock ON At Close>	119
Locking Keypad Dial . . . . . <Keypad Dial Lock>	119
Preventing Side Key Operation . . . . . <Side Keys Guard>	120

## Restricting Outgoing/Incoming Calls or Messages

Setting not to Display Redial/Received Calls . . . . . <Record Display Set>	120
Protecting Phonebook Entries and Schedule Events from Prying Eyes . . . . . <Secret Mode> <Secret Data Only>	120
Applying Secret for Mail in Mail Box . . . <Secret Mail Display>	121
Setting not to Display Mail in Mail Box without Permission . . . . . <Mail Security>	121
Setting Restrictions on Phonebook Entries . . . <Restrictions>	122
Setting Response to Incoming Calls without Caller ID . . . . . <Call Setting without ID>	123
Delaying Start of Ringing Operation . . . . . <Ring Time>	124
Rejecting Incoming Calls from Phone Numbers which are not Stored in Phonebooks . . . . . <Reject Unknown>	124
Rejecting Incoming Videophone Calls . . . . . <Reject Videophone>	125
What is Data Security Service? . . . . .	125

## Other “Security Settings”

Other “Security Settings” . . . . .	125
-------------------------------------	-----

## Passwords

For some functions of the FOMA phone, you need to enter your password. In addition to the Terminal Security Code for operating respective mobile phone functions, the Network Security Code to use network services, and i-mode password are available. These passwords help you utilize your FOMA phone.

### ■ Cautions on passwords

- You should avoid using the numbers for passwords such as denoting your birth date, part of your phone number, local address number, room number, "1111" or "1234" that is easily decoded by a third party. Also make sure that you take a note of the passwords you have selected just in case you forget them.
- Take care not to let others know your passwords. Even if your passwords are known and used by a third party, we at DOCOMO take no responsibility in any event for the resultant loss.
- Note that we at DOCOMO will never make any inquiries about your passwords.
- If you do not remember your respective passwords, you need to bring an identification card such as your driver's license, the FOMA phone and UIM to the handling counter of a DOCOMO shop.  
For details contact "DOCOMO Information Center" on the back page of this manual.

## Terminal Security Code

The Terminal Security Code is set to "0000" at purchase but you can change it by yourself. (See page 115)

When the display for entering the Terminal Security Code appears, enter your four- to eight-digit code and press  (Set).

- When you enter your Terminal Security Code, the entered numbers are indicated by "\_" and not displayed.
- If you have entered wrong numbers or nothing for about 15 seconds, a warning tone sounds and a warning message is displayed; then the display prior to entering the Terminal Security Code returns. Check the correct code and retry entering numbers.

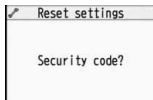

## Network Security Code

The Network Security Code is a four-digit number for procedures on DOCOMO e-site or for using network services. This is determined at the time of contract but can be changed by yourself.

If you have "docomo ID/Password" for "My docomo", the overall support site for personal computers, you can use a personal computer to take proceedings of changing your Network Security Code to new one. Also, you can change it by yourself from "各種手続き (procedures)" on DOCOMO e-site by using the i-mode phone.

※ For "My docomo" and "DOCOMO e-site (ドコモeサイト)", see the back of the back page of this manual.

## i-mode Password

You need to enter the four-digit "i-mode password" for registering or deleting My Menu, applying for or canceling Message Services, i-mode pay service, and so on. (Some information providers may provide you with their specific password.)

The i-mode password is "0000" at the time of your contract, but you can change it by yourself. (See page 155)

From i-mode, you can change the i-mode password by following operation:

 Menu → "English" → "Options" → "Change i-mode Password"

## PIN1 Code/PIN2 Code

For the UIM, you can set the two security codes, namely the PIN1 code and PIN2 code. These security codes are "0000" at the time of your contract, but you can change them by yourself. (See page 116)

The PIN1 code is the four- to eight-digit number for checking the user each time the UIM is inserted into the FOMA phone or each time the FOMA phone is turned on, so that you can prevent the third party from using your UIM. By entering your PIN1 code, you can make or answer calls, or use functions in the FOMA phone.

The PIN2 code is the four- to eight-digit number for executing Reset Total Cost, using the user certificate or applying for the issue of it, etc.

- If you purchase a new FOMA phone and use the existing UIM with the new FOMA phone, use the PIN1 code and PIN2 code you have set previously.



When the PIN1 Code/PIN2 Code Entry display appears, enter your four- to eight-digit PIN1 code/PIN2 code and press .

- The entered PIN1 code/PIN2 code is displayed as " \* ".
- If you enter a wrong PIN1 code/PIN2 code three times in succession, it is locked and the FOMA phone cannot be used. (The remaining number of times you can enter appears on the display.)

When you enter the correct PIN1 code/PIN2 code, the remaining number of times you can enter will return to three times.

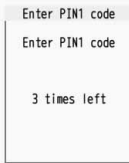

For PIN1 code

## PUK (PIN Unblock Code)

The PUK (PIN unblock code) is the eight-digit number for releasing the PIN1 code and PIN2 code lock state. You cannot change this code by yourself.

- If you enter a wrong PUK (PIN unblock code) 10 times in succession, the UIM is locked.

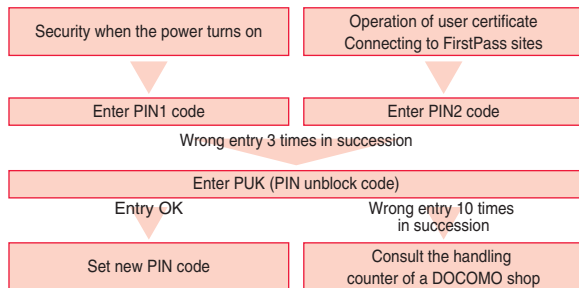

<Change Security Code>

MENU 2 9

## Changing Terminal Security Code

Change the default for the Terminal Security Code required for operating functions to your own four- to eight-digit code so that you can make full use of the FOMA phone. Make sure you take a note of the security code you have changed just in case you forget it.

- 1  Settings ▶ Lock/Security ▶ Change security code  
▶ Enter the current Terminal Security Code.

- If you enter the code for the first time, enter "0000".

- 2 Enter a new Terminal Security Code (four to eight digits)  
▶ YES

<UIM Setting>

## Setting PIN Code

### PIN1 Code Entry Set

You can set the FOMA phone not to work unless you enter your PIN1 code when turning on the power.

- 1  Settings ▶ Lock/Security ▶ UIM setting  
▶ Enter your Terminal Security Code  
▶ PIN1 code entry set ▶ ON or OFF  
▶ Enter the PIN1 code.

- See page 114 for the PIN1 code.

## Change PIN1 Code/Change PIN2 Code

You need to have set "PIN1 code entry set" to "ON" to change the PIN1 code.

- 1  **Settings** ▶ **Lock/Security** ▶ **UIM setting**  
▶ **Enter your Terminal Security Code**  
▶ **Change PIN1 code or Change PIN2 code**  
▶ **Enter the current PIN1 code/PIN2 code.**

- See page 114 for the PIN1 code/PIN2 code.

- 2 **Enter a new PIN1 code/PIN2 code (four to eight digits).**

- The entered PIN1 code/PIN2 code is displayed as " \_".

- 3 **Enter the new PIN1 code/PIN2 code again.**

## Releasing PIN Lock

If you enter a wrong PIN1 code/PIN2 code three times in succession on the display requiring its entry, it is locked and the FOMA phone cannot be used. In this case, release the PIN1 code/PIN2 code lock and set a new PIN1 code/PIN2 code.

- 1 **Enter the PUK (PIN unblock code) (eight digits).**

- The entered unblock code is displayed as " \_".

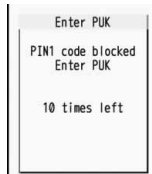

- 2 **Enter a new PIN1 code/PIN2 code (four to eight digits).**

- The entered PIN1 code/PIN2 code is displayed as " \_".

- 3 **Enter the new PIN1 code/PIN2 code again.**

<Lock All>

## Locking your Phone to Prevent Use by Others



If you set Lock All, you can do no operations other than answering calls and turning on/off the power.

- 1  **Settings** ▶ **Lock/Security** ▶ **Lock all**  
▶ **Enter your Terminal Security Code.**

"" and "Lock all" appear and Lock All is set.

- To release Lock All, enter your Terminal Security Code from the Stand-by display. Even if you turn off the power, Lock All will not be released.

### Information

- You cannot make calls during Lock All. However, you can make emergency calls at 110/119/118. Select "YES" from the confirmation display for dialing.
- You can receive calls, but the callers' data such as their names and images stored in the Phonebook are not displayed except for their phone numbers. Further, the default ring tone sounds.
- If you fail to release Lock All five times in succession, the power to the FOMA phone turns off. However, you can turn it on again.
- You can receive mail messages or Messages R/F during Lock All; however, the Receiving or Reception Result display for incoming mail messages and Messages R/F does not appear. The icons such as "", "", or "" appear after Lock All is released.
- During Lock All, the notification icons, desktop icons, and schedule events are not displayed on the desktop. When Lock All is released, they are displayed.
- The tickers of i-Channel are not displayed during Lock All.
- The default Wake-up display appears during Lock All even when an i-motion movie has been set for the Wake-up display.
- Even if you set Lock All, IC Card Lock is not activated.

## <Omakase Lock>

# Using Omakase Lock

When you have lost your FOMA phone or in other cases, you can use this service to remotely lock the FOMA phone in which your contracted UIM is inserted by contacting DOCOMO or by operating from My docomo. To release the lock, contact DOCOMO by phone, etc.

※ Omakase Lock is a pay service. However, you are not charged if you apply for this service at the same time as applying for the suspension of the use or during the suspension.

### ■ Setting/Releasing Omakase Lock

 0120-524-360 Business hours: 24 hours

※ You can set/release also from My docomo site via a personal computer or other devices.

● For details on Omakase Lock, refer to "Mobile Phone User's Guide [i-mode] FOMA version".

"Omakase lock" is displayed on the Stand-by display and Omakase Lock is set.

- During Omakase Lock, all the key operations are locked and respective functions (including IC card functions) are disabled, except for answering voice calls/videophone calls, putting them on answer-hold (On Hold), turning on/off the power, adjusting the earpiece volume and adjusting the ring volume.
- You can receive voice calls and videophone calls, but the callers' data such as names and images stored in the Phonebook are not displayed except for their phone numbers. In addition, the ring image and ring tone are reset to the default. When you release Omakase Lock, the former settings return.
- Mail messages received during Omakase Lock are held at the Mail Center.
- You can turn on/off the power, however, Omakase Lock is not released by turning off the power.
- Note that neither the UIM nor the microSD card is locked.

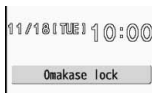

### Information

- Even while another function is working, Omakase Lock applies after finishing that function.
- Omakase Lock can be set even when another lock function is set. However, if you have set Public Mode (Drive Mode) before setting Omakase Lock, you cannot receive voice calls and videophone calls.

### Information

- Omakase Lock cannot be set when the FOMA phone is out of the service area, turned off, or during Self Mode.
- When you have signed up for Dual Network Service and are using the mova phone, Omakase Lock cannot be set.
- Even when the contractor and the user of the FOMA phone differ, the FOMA phone will be locked if the contractor offers to DOCOMO.

## <Self Mode>

# Using Self Mode

You can disable all phone calls and communication functions. During Self Mode, the caller hears the guidance to the effect that radio waves do not reach or the power is turned off. If you use DOCOMO Voice Mail Service or Call Forwarding Service, you can use these services in the same way as when the FOMA phone is turned off.

1  Settings ▶ Lock/Security ▶ Self mode ▶ YES ▶ OK

" Self" appears and Self Mode is set.

- To release Self Mode, perform the same operation.

### Information

- You can make emergency calls at 110/119/118 even during Self Mode. In this case, Self Mode is released.
- You cannot receive mail messages, Area Mail messages, or Messages R/F during Self Mode.
- Even if a call comes in during Self Mode, the "Missed call" icon does not appear after releasing Self Mode.

## &lt;Personal Data Lock&gt;

## Locking Functions Regarding Personal Information

To prevent other people from reading or tampering with your personal information, you can set the following functions not to be used:

- Record message
- Play/Erase msg.
- Select image
- Add to phonebook
- Group setting
- No. of phonebook
- Phonebook settings
- Search phonebook
- Voice dial
- Voice announcement
- Kisekae Tool
- Feel \* Mail image playback
- Desktop
- Restrictions
- Reject unknown
- Camera
- Bar code reader
- Text reader
- i-mode
- Bookmark
- i-Channel
- Mail
- Photo-sending
- Mail group
- Chat group
- i-oppli
- IC card content
- ToruCa
- 1Seg
- Full browser
- Still image
- Moving image
- Video
- Chara-den
- Melody
- microSD card
- Infrared data exchange
- iC communication
- PDF viewer
- Document viewer
- Music&Video Channel
- MUSIC
- MUSIC player
- Alarm
- Schedule
- ToDo
- Alarm setting
- Own number
- Voice memo
- Movie memo
- Voice recorder
- Text memo
- UIM operation
- Reset settings
- Initialize
- "Number setting" and "Set as ring tone" for Multi number
- Data transfer

### 1 Settings ▶ Lock/Security ▶ Personal data lock ▶ Enter your Terminal Security Code.

 appears and Personal Data Lock is set.







- To release Personal Data Lock, perform the same operation. When Timer Lock ON At Close is set, the display for releasing Personal Data Lock appears also by opening the FOMA phone.

### To temporarily release Personal Data Lock

When you select a function which cannot be used during Personal Data Lock, the display for entering your Terminal Security Code appears depending on the function. When you enter your Terminal Security Code,  is cleared and you can temporarily use the function.

- When you show the Stand-by display while no menu function is activated, Personal Data Lock is set again.

#### Information

- You can automatically receive Messages R/F, i-mode mail messages, chat mail messages, and SMS messages during Personal Data Lock; however, the Receiving or Reception Result display does not appear. Further, the receiving operation such as ringing/vibration does not work, so you are not notified of receiving. The icons such as , , or  appear after Personal Data Lock is released.
- During Personal Data Lock, the "Notification icon" and "Desktop icon" such as "New mail", "Missed alarm", "Phone number", "URL" and "Mail address" do not appear, however, they reappear when you release Personal Data Lock.
- During Personal Data Lock, you cannot check a missed call or new mail by pressing  with the FOMA phone closed.
- During Personal Data Lock, the "Pre-installed" substitute image is sent to the other party if you send the substitute image during a videophone call.
- If you set "Lock all" during Personal Data Lock,  is cleared and  appears instead.
- You cannot set Personal Data Lock while "Reject unknown" is set.

## Setting Lock by Closing the FOMA Phone

- 1  **Settings** ▶ **Lock/Security** ▶ **Timer lock ON at close**
  - ▶ **Enter your Terminal Security Code**
  - ▶ **Personal data lock or IC card lock**
  - ▶ **Select an elapse time.**

If you set to other than "OFF", "📞" appears and then Timer Lock ON At Close is set. After each lock is activated, the Lock Release display appears when you open the FOMA phone.

### Information

- When the Stand-by display is not shown, or when another function is working with the Stand-by display shown, the lock is not activated even after the specified time elapses. However, when another function ends after closing the FOMA phone, the lock is activated after the specified time elapses.
- When a call or mail message comes in after closing the FOMA phone, or when you open it, the elapsed time counter returns to 0 seconds.
- When this function is activated, the lock is temporarily released if you release each lock. However, it is re-locked when the specified time elapses after closing the FOMA phone.

## Locking Keypad Dial

You can lock dialing from the numeric keys. When using the FOMA phone for business purposes, private use of the FOMA phone can be prevented.

### Unavailable operations

- Dialing from the numeric keys
- Initial setting
- Phonebook (storing, editing, deleting, copying from the microSD card, sending/receiving using Infrared rays, and sending/receiving using iC communication)
- Phone To/AV Phone To function
- Mail To function

### Available operations

- Dialing from the Phonebook or Voice Dial
- Dialing from Redial, Dialed Calls, Received Calls, Sent Address, or Received Address (Only phone numbers stored in the Phonebook)

- 1  **Settings** ▶ **Lock/Security** ▶ **Keypad dial lock**
  - ▶ **Enter your Terminal Security Code.**

"📞" is displayed and Keypad Dial Lock is set.

- To release Keypad Dial Lock, perform the same operation.

### Information

- You can make emergency calls at 110/119/118 using numeric keys even during Keypad Dial Lock.
- If you set Keypad Dial Lock, you can send mail only when the address is called up from the Phonebook and when the address stored in the Phonebook is called up from Sent Address or Received Address.



## &lt;Side Keys Guard&gt;

## Preventing Side Key Operation

You can disable the side keys  and  for when the FOMA phone is closed.

You can prevent operation errors in a bag.

1   (for at least one second)

""  

• To set to "OFF", perform the same operation.

## Information

- When an external device such as the Flat-plug Earphone/Microphone with Switch (option) is connected, the function of the side keys is valid regardless of this setting.

## &lt;Record Display Set&gt;

## Setting not to Display Redial/Received Calls

1  **Settings**  **Incoming call**  **Record display set**  
 **Enter your Terminal Security Code**  **Select an item.**

**Received calls** . . . . . Sets whether to display Received Calls and Received Address.

**Redial/Dialed calls** . . . . . Sets whether to display Redial, Dialed Calls and Sent Address.

## 2 ON or OFF

- When you set "Received calls" to "OFF", you cannot play back record messages of voice calls, either.

## &lt;Secret Mode&gt; &lt;Secret Data Only&gt;



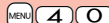

## Protecting Phonebook Entries and Schedule Events from Prying Eyes

In ordinary mode, you cannot access/refer to Phonebook entries or schedule events stored as secret data. In Secret Mode, you can select whether to store the stored/edited Phonebook entries/schedule events as secret data or as ordinary data. The Phonebook entries/schedule events you have stored/edited in Secret Data Only are stored as secret data. You can access/refer to all the data files in Secret Mode but can access/refer to only the secret data files in Secret Data Only.

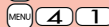

## Activate Secret Mode



## Activate Secret Data Only

1  **Settings**  **Lock/Security**  
 **Secret mode or Secret data only**  
 **Enter your Terminal Security Code.**

When "Secret mode" is selected, "" appears and Secret Mode is activated. When "Secret data only" is selected, "" blinks, the number of stored secret data items is displayed, and then Secret Data Only is activated.

- If you call up a Phonebook entry or schedule event in Secret Mode, "" stays lit for ordinary data and "" blinks for secret data.
- To deactivate Secret Mode or Secret Data Only, perform the same operation or press  from the Stand-by display.

## To change secret data to an ordinary Phonebook entry or schedule event

In Secret Mode or Secret Data Only, select "Release secret" from the Function menu of the Phonebook entry or schedule event to be released.

### Information

- Only the Phonebook entries in the FOMA phone can be stored as secret data.
- When you make a call to the party stored as secret data, his/her name is not displayed but the phone number is displayed on the Dialing/Talking display.
- If you call up a secret entry to make a call or send mail, the record is not stored in "Redial", "Dialed calls" or "Sent address".
- If you simultaneously activate "Lock all" and "Secret mode" or "Secret data only", deactivating "Lock all" deactivates "Secret mode" or "Secret data only".

## <Secret Mail Display>

### Applying Secret for Mail in Mail Box

You can set whether to display the mail (secret mail) message from the sender or to the destination address that matches secret data in the Phonebook.

- 1  Mail settings ▶ Secret mail display  
▶ Enter your Terminal Security Code ▶ ON or OFF

### Information

- Even when "Secret mail display" is set to "OFF", you can check secret mail in Secret Mode or in Secret Data Only.
- When "Secret mail display" is set to "OFF", and any secret address is included in addresses of simultaneous mail, that mail message is not displayed.
- When "Secret mail display" is set to "OFF", and any secret member is included in chat members, chat mail messages of all chat members are not displayed.
- When "Secret mail display" is set to "OFF", Area Mail messages are not displayed in Secret Data Only.

## <Mail Security>

### Setting not to Display Mail in Mail Box without Permission

You can set the security function for the Inbox, Outbox and Draft of the Mail menu.

You need to enter your Terminal Security Code to display the mail messages in security-activated boxes.



- 1  Mail settings ▶ Mail security  
▶ Enter your Terminal Security Code  
▶ Put a check mark for boxes to be set  (Finish)
  - When security is set, "F" is added to the icon of the set box in the Mail menu.

### Information

- If you set security for the Outbox and Inbox, mail addresses are not stored in Sent Address and Received Address.

## Setting Restrictions on Phonebook Entries

### Restrict Dialing

You can disable making voice calls and videophone calls to phone numbers other than specified ones. When you use the FOMA phone for business use, this function is useful for preventing the private use. Bring up the specified Phonebook entry and press  or  (Dial) to make a voice call. (To make a videophone call, press  (V. phone).) You can specify up to 20 phone numbers.

### Call Rejection

You can reject voice calls and videophone calls from specified phone numbers. You can set only the calls you do not want to receive to be rejected. The caller hears a busy tone. You can specify up to 20 phone numbers. This function is valid only when the other party notifies his/her phone number. It is advisable to activate "Caller ID request" and "Call setting w/o ID" simultaneously.

### Call Acceptance

You can receive voice calls and videophone calls only from specified phone numbers. You can set only the calls you want to accept to be connected. You can specify up to 20 phone numbers. This function is valid only when the other party notifies his/her phone number. It is advisable to activate "Caller ID request" simultaneously.

## Restrict Dialing/Call Rejection/Call Acceptance

### 1 Detailed Phonebook display ( FUNC ) Restrictions Enter your Terminal Security Code Select an item.

**Restrict dialing** . . . You can dial the specified phone numbers only.





**Call rejection** . . . . You can reject calls from the specified phone numbers.

**Call acceptance** . . . You can accept calls from the specified phone numbers only.

**Call forwarding** . . . See page 391.

**Voice mail** . . . . . See page 388.

The set item is indicated by "★".

- When a Phonebook entry contains multiple phone numbers, press  on the detailed display to highlight the phone number you will set Restrictions for.
- To set Restrict Dialing for multiple phone numbers, first set Restrict Dialing and press  to return to the detailed Phonebook display;  to highlight the phone number to be set for Restrict Dialing and continue the operation. If you press  to return to the Stand-by display, additional settings cannot be done. To do additional settings, release Restrict Dialing for the set phone number and activate Restrict Dialing again, including the released phone number.
- To release Restrictions, perform the same operation.

### Information

- You cannot set this function for Phonebook entries stored as secret data, and in the UIM Phonebook.
- If you activate "Personal data lock" while "Call rejection" or "Call acceptance" is set, you can accept all incoming calls.
- You cannot operate the following while "Restrict dialing" is set:
  - Calling up/Referring to phone numbers other than specified
  - Keypad dial (except for the calls to the specified phone numbers)
  - Dialing from Received Calls (except for the calls from the specified phone numbers)
  - Storing/Editing/Deleting Phonebook entries, copying Phonebook entries from the microSD card, and copying Phonebook entries to the UIM
- You can make emergency calls at 110/119/118 even if you set "Restrict dialing".



## Information

- When a call comes in from the phone number set with "Call rejection", or from other than the phone number set with "Call acceptance", the call is stored in "Received calls" as a missed call record and the "Missed call" icon appears on the Stand-by display. Also, the caller hears a busy tone even if you have set Voice Mail Service or Call Forwarding Service to "Activate". However, if you set the ring time for Voice Mail Service or Call Forwarding Service to 0 seconds, when the FOMA phone is out of the service area, or when the power is turned off, the busy tone will not be played back, activating Voice Mail Service or Call Forwarding Service.
- You can receive SMS messages or i-mode mail messages regardless of the setting of "Call rejection" or "Call acceptance".

## Check/Release Restrictions on Phonebook Entries

### 1 ► Phonebook ► Restrictions ► Enter your Terminal Security Code ► Select an item.

- The set item is indicated by "★".
- To release all the Phonebook entries set with Restrictions, press  (FUNC), select "Release", and then select "YES".

### 2 Select a Phonebook entry.

The phone number set with Restrictions is displayed.

- To release "Restrictions" per phone number, select the phone number you want to release by following the same steps above, and select "YES".

<Call Setting without ID>



## Setting Response to Incoming Calls without Caller ID

You can set whether to receive (accept) or not to receive (reject) a voice call and videophone call depending on the reason for no caller ID. There are three reasons; "Unavailable", "PublicPhone", and "User unset".

### 1 ► Settings ► Lock/Security ► Call setting w/o ID ► Enter your Terminal Security Code ► Select an item.

**Unavailable** . . . . Calls from the other party who cannot notify his/her phone number such as calls from overseas or from landline phones via call forwarding services.

(However, the caller ID might be notified depending on the telephone companies the calls go through.)

**PublicPhone** . . . . Calls from public phones, etc.

**User unset** . . . . . When the caller has set the caller ID not to be notified.

### 2 Accept or Reject

- If you select "Accept", go to step 2 on page 92 to select a ring tone. If you select "Same as ring tone", the ring tone will be the one selected in "Phone" of "Select ring tone".

## Information

- If you select "Reject", the ring tone does not sound even if a call comes in, the call is stored in "Received calls" as a missed call record and the "Missed call" icon appears on the Stand-by display. Also, the caller hears a busy tone even if you have set Voice Mail Service or Call Forwarding Service to "Activate". However, if you set the ring time for Voice Mail Service or Call Forwarding Service to 0 seconds, when the FOMA phone is out of the service area, or when the power is turned off, the busy tone will not be played back, activating Voice Mail Service or Call Forwarding Service.
- You can receive SMS messages or i-mode mail messages regardless of this setting.

&lt;Ring Time&gt;



## Delaying Start of Ringing Operation

- 1 Settings ▶ Incoming call ▶ Ring time  
▶ Do the following operations.

Item	Operation/Explanation
Ring start time	<p>You can set the FOMA phone not to start ringing operation immediately for when a voice call or videophone call comes in from the party whose phone number is not stored in the Phonebook. This function is effective as a countermeasure for blocking nuisance calls such as one ring phone scam (one-girl).</p> <p>▶ <b>ON or OFF</b> ▶ Enter a start time (seconds). ● Enter from "01" through "99" in two digits.</p>
Missed calls display	<p>You can set whether to display the call disconnected within the time specified for "Ring start time" in Received Calls.</p> <p>▶ <b>Display or Not display</b></p>

### Information

- When a call comes in from the party whose phone number is stored in the Phonebook, the FOMA phone starts ringing as soon as the call comes in even if "186"/"184" is added to the phone number. However, during Personal Data Lock, or for the call from the party whose phone number is stored as secret data, ringing starts according to the setting of this function.
- If the ring start time is longer than the ring time for Record Message Setting, the ringing operations do not start, activating Record Message instead. To activate Record Message after starting the ringing operations, set the longer ring time for Record Message Setting than the ring start time. The same applies to the ring time for Voice Mail Service, Call Forwarding Service, and Auto Answer Setting.

&lt;Reject Unknown&gt;

## Rejecting Incoming Calls from Phone Numbers which are not Stored in Phonebooks

You can reject voice calls and videophone calls from the party whose phone number is not stored in the Phonebook.

This function is valid only when the other party notifies his/her phone number. It is advisable to activate "Caller ID request" and "Call setting w/o ID" simultaneously.

- 1 Settings ▶ Lock/Security ▶ Reject unknown  
▶ Enter your Terminal Security Code ▶ Accept or Reject

### Information

- If a call comes in from the party whose phone number is stored as secret data, the call is not rejected, regardless of this setting.
- If you simultaneously activate "Reject unknown" and "Call acceptance" of "Restrictions", the latter has priority.
- When a call comes in from anyone whose phone number is not stored in the Phonebook while you set this function to "Reject", the call is stored in "Received calls" as a missed call record, and the "Missed call" icon appears on the Stand-by display. Also, the caller hears a busy tone even if you have set Voice Mail Service or Call Forwarding Service to "Activate". However, if you set the ring time for Voice Mail Service or Call Forwarding Service to 0 seconds, when the FOMA phone is out of the service area, or when the power is turned off, the busy tone will not be played back, activating Voice Mail Service or Call Forwarding Service.
- Even when this function is set to "Reject", your FOMA phone follows the settings specified by "Call setting w/o ID" if each setting of "Call setting w/o ID" is set to "Accept".
- You can receive i-mode mail and SMS messages regardless of this setting.
- You cannot set "Reject unknown" during Personal Data Lock.
- You cannot set "Reject unknown" to "Reject" while "Ring start time" of "Ring time" is set to "ON".

<Reject Videophone>

## Rejecting Incoming Videophone Calls

- 1  Settings ▶ Videophone ▶ Reject videophone  
▶ Enter your Terminal Security Code ▶ ON or OFF

## What is Data Security Service?

You can back up the Phonebook by auto-updating. Data Security Service enables you to save the Phonebook entries, images, and mail messages stored in your FOMA phone to the Data Storage Center and to restore the saved data files when you have lost or replaced your FOMA phone.

Further, you can notify of your mail address change to multiple addresses at a time. You are not charged a packet communication fee for mail sending. If any personal computer (My docomo) is available, you can use this service more conveniently.

- For details on Data Security Service, refer to "Mobile Phone User's Guide [i-mode] FOMA version".

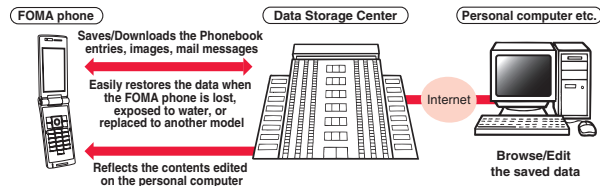

- Data Security Service is a pay service that is available on a subscription basis. (You need to subscribe to i-mode to apply for Data Security Service.)

## Other "Security Settings"

Other than introduced in this chapter, the following functions/services for the Security Settings are available:

If you want	Functions/Service name	Reference page
To protect the IC card function from being used illegally	IC Card Lock	246
To prevent crank calls or vicious sales calls from incoming	Nuisance Call Blocking Service	391
To prevent the incoming call that does not notify a caller ID	Caller ID Request	392
To ensure safe and reliable data communication by using electronic authentication services ※ Limited to FirstPass sites	FirstPass	167
To update software programs in the FOMA phone when necessary	Software Update	465
To protect the FOMA phone from data liable to cause trouble	Scanning Function	471
To receive necessary mail only from among the large volume of incoming mail	Receive Option	186

If you want	Functions/Service name	Reference page
To store/check safety information using i-mode when a disaster occurs	i-mode Disaster Message Board Service	※
To change the mail address	Change Mail Address	
To reject mail with URL	Spam Mail Prevention (Reject Mail with URL)	
To accept or reject mail from the specified domain	Spam Mail Prevention (Reject/Receive Mail Settings)	
To accept or reject mail between i-mode mobile phones only		
To accept or reject mail from the specified address		
To set the recommended Spam Mail Prevention easily	Spam Mail Prevention (Easy Mail Setting)	
To reject the 500th and succeeding i-mode mail messages sent from a single i-mode phone on the same day	Spam Mail Prevention (Reject Mass i-mode Mail Senders)	
To reject SMS messages	Spam Mail Prevention (SMS Rejection Settings)	
To reject advertising mail that is sent unilaterally	Reject Unsolicited Ad Mail	
To restrict the file size of incoming mail	Limit Mail Size	
To confirm the settings for the mail function	Confirm Settings	
To stop the mail function temporarily	Suspend Mail	
To check whereabouts of lost mobile phone	Keitai-Osagashi Service	

※ Refer to "Mobile Phone User's Guide [i-mode] FOMA version"

### Information

- The priority order of functions simultaneously set to prevent nuisance calls is as follows: "Nuisance Call Blocking Service" → "Call rejection" → "Reject unknown/Call setting w/o ID" → "Ring time".

# Camera

Before Using Cameras .....	128
Shooting Still Images .....	<Still Image Shoot> 135
Shooting Moving Images .....	<Moving Image Shoot> 137
Changing Settings for Shooting Images .....	139
Setting Image Size and Image Quality .....	140
Using Bar Code Reader .....	<Bar Code Reader> 143
Using Text Reader .....	<Text Reader> 146

## ■ Copyrights and Portrait Rights

You have no right to copy, modify, or distribute the contents of which a third party holds the copyright such as text, image, music, or software programs downloaded from web pages on the Internet, or recorded using this product, without permission from the copyright holder except for when the copy or quote is for personal use that is allowed by the copyright law.

Note that it may be prohibited to shoot or record live performances or exhibitions even for personal use.

Make sure that you refrain from shooting portraits of other persons and distributing such portraits over the Internet without consent, as this may violate portrait rights.



- You may be imposed punishment according to the law and rule (such as the nuisance prevention ordinance) if you use the FOMA phone to give a remarkable nuisance and misdeed to the public.



Please be considerate of the privacy of individuals around you when shooting and sending photos using camera-equipped mobile phones.

## Before Using Cameras

### Notes for when Shooting Images

- Check the lens for any stain before shooting. If the lens is stained, clean the lens with a soft cloth. If the lens is stained with fingerprints or something oily, you will not be able to focus on a subject, or the stains are reflected on still or moving images you shoot.
- Make sure that you do not let fingers, hairs, or the strap overlap the lens when shooting.
- Make sure that you hold the FOMA phone securely with your hands so that it does not move when shooting. Otherwise, the image may be blurred, especially in a dark place.
- Do not leave the FOMA phone with the lens pointing direct to the sunlight. Pixels may be discolored or burns may result.
- If you shoot under a fluorescent lamp, mercury lamp, or sodium lamp flickering at high speeds, "flicker symptom", horizontal stripes flow from top to bottom or left to right of the display, may result. The color tone for the image may vary depending on a shooting timing.
- If you shoot a subject containing an area of an extremely high brightness such as the reflection of sun light, the bright area might be black-spotted but this is not a malfunction.
- Images shot by the camera might differ from actual subjects in color tone and brightness.
- When the battery level is low, you may not be able to save still or moving shot images.
- A slight time lag is found between when you press  (Record) and when you actually shoot. Therefore, if you shoot a fast moving subject, the subject might be shot with its position slightly away from the one you see it when you press .
- Do not remove the microSD card while saving files to it. The FOMA phone or microSD card could malfunction.
- If you turn off the power while saving a file, an incomplete file may be saved.

- If the battery pack is removed off while saving a file to the FOMA phone or microSD card, that data becomes contingent.
- You need to obtain a microSD card separately to use the functions related to the microSD card.  
The microSD card is available at mass retailers for home electric appliances, etc. (See page 305)

### Use Cameras

You can use the camera to shoot still or moving images.

The camera comes with the automatic focusing function to automatically focus on subjects. (See page 139) The Image Stabilizer function enables you to shoot images with less blur. (See page 141) You can easily operate the main functions for shooting not only from the Function menu but also by operating the keys.

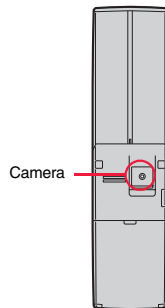

## ■ Keys used for shooting

Icon menu operation		White balance	
Function menu access		Photo mode	
Bar code reader		Image quality	
Shutter/Save		Image size	
Tele		Image stabilizer (in Photo Mode)	
Wide		Auto timer	
Switch settings for Focus**1		Store in**4	
Autofocus		End camera (in ordinary time)	
Change camera-mode**2		Release focus lock (when focus is locked)	
Icons**3		End camera	
Brightness			

\*\*1 Each time of pressing switches in order of "Auto"→"Close-up"→"Landscape".

\*\*2 Each time of pressing switches in order of "Photo mode"→"Movie mode"→"Continuous mode".

\*\*3 Each time of pressing switches between "ON" and "OFF".

\*\*4 Each time of pressing switches between "Phone" and "microSD".

## Information







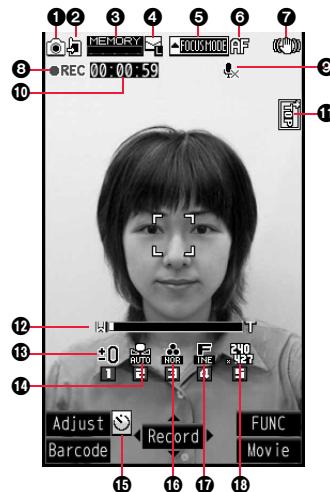





- While the camera is activated, the Call/Charging indicator flickers. You cannot turn off flickering.
- You cannot change or silence the volume of the shutter sound. You cannot set a downloaded melody for the shutter sound, either.
- If no key operation is done on the Finder display, the camera is automatically deactivated after about three minutes.
- When you shoot in a dark place, ensure to set "Photo mode" of "Camera settings" to "Night mode".
- You can operate the following by the Icon menu: "Brightness", "White balance", "Photo mode", "Image quality", and "Image size".

















## Camera Setting and Finder Display

On the Finder display, the settings are indicated by bars and icons.



Icon/bar name	Icon	Description	Page
1 Camera mode		Photo mode	135
		Movie mode	137
		Continuous mode (Auto, Manual, Auto bracket)	135
2 Store in		Phone: Stores in the FOMA phone.	140
		microSD: Stores on the microSD card.	

Icon/bar name	Icon	Description	Page
⑤ Number of recordable image	—	Number of remaining recordable still images Up to 999 images are displayed.	—
		Memory usage state (estimate) in Movie mode Displayed in red when the memory space reaches maximum.	—
④ File size setting		Mail restrict'n (S): Up to 500 Kbytes can be saved.	140
		Mail restrict'n (L): Up to 2 Mbytes can be saved.	
		Long time: Long time recording is possible.	
⑤ Focus guide		Focus guide	—
⑥ Focus		Auto	140
		Close-up	
		Landscape	
⑦ Image stabilizer		Auto	141
⑧ Shooting status		During moving image recording	137
⑨ Movie type set		Records only the video.	141
⑩ Recordable time	—	Recordable time (estimate) for moving images	—
⑪ Top icon		Shows the vertical direction of the still or moving image.	—
⑫ Zoom bar		Zooming status	139
⑬ Brightness	-3 ~ +3	Brightness of shot image	140

Icon/bar name	Icon	Description	Page
① White balance		Auto: For adjusting white balance automatically	140
		Fine: For shooting outdoors in fine weather	
		Cloudy: For shooting in cloudy weather or in the shade	
		Light bulb: For shooting under incandescent light	
		Fluorescent light: For shooting under fluorescent light	
② Number of frames for continuous shooting		Number of frames at "Manual" shooting in "Continuous mode"	141
	Auto timer	ON	143
⑩ Photo mode		Normal	140
		Portrait	
		Sports	
		Food	
		Scenery	
		Night mode	
		Backlight	
⑪ Image quality		Normal: Standard quality	140
		Fine: Fairly high quality	
		Super fine: High quality	



Icon/bar name	Icon	Description	Page	
⑩ <b>Image size</b> (Photo mode/ Continuous mode)		2M (1600 x 1200)	140	
		1.4M Wide (1600 x 900)		
		1M (1280 x 960)		
		Stand-by (240 x 427)		
	Photo shooting			VGA (640 x 480)
				CIF (352 x 288)
				QVGA (240 x 320)
				QCIF (176 x 144)
				Sub-QCIF (128 x 96)
	<b>Image size</b> (Movie mode)			VGA (640 x 480)
		HVGA Wide (640 x 352)		
		QVGA (320 x 240)		
		QCIF (176 x 144)		
		Sub-QCIF (128 x 96)		

## Specifications for Still Image Shooting

File format	JPEG
Compression format	Baseline format
Extension	jpg
Title/File name	Automatically set according to the date and time the image was saved and the number of shot frames (when the 1st frame was shot at 10:00 on November 18, 2008) Title "2008/11/18 10:00" File name "2008111810000000" (Store in: Phone) "P1000001" (Store in: microSD)
Maximum file size	700 Kbytes
Mail attachment/Output	Can be attached to mail or output from the FOMA phone by using the microSD card.
Memory capacity	Approx. 111.6 Mbytes (Phone)

## Estimate of the number of storable still images

The number of files that can be saved varies depending on shooting environments.

※The number of files that can be saved to the FOMA phone and microSD card has limit.

### ■The number of files that can be saved to P706i<sub>p</sub>

Image quality Image size	Super fine (Approx.)	Fine (Approx.)	Normal (Approx.)
2M (1600 x 1200)	167	230	285
1.4M Wide (1600 x 900)	232	332	446
1M (1280 x 960)	232	332	446
VGA (640 x 480)	1,143	1,360	1,587
Stand-by (240 x 427)	2,041	2,597	3,500
CIF (352 x 288)	2,041	2,597	3,500
QVGA (240 x 320)	2,381	3,175	3,500
QCIF (176 x 144)	3,500	3,500	3,500
Sub-QCIF (128 x 96)	3,500	3,500	3,500

●The values are the number of files you can save after deleting the deletable pre-installed data files.

### ■The number of files that can be saved to the microSD card (64 Mbytes)

Image quality Image size	Super fine (Approx.)	Fine (Approx.)	Normal (Approx.)
2M (1600 x 1200)	89	122	152
1.4M Wide (1600 x 900)	122	172	223
1M (1280 x 960)	122	172	223
VGA (640 x 480)	608	724	845
Stand-by (240 x 427)	1,087	1,383	1,902
CIF (352 x 288)	1,087	1,383	1,902
QVGA (240 x 320)	1,268	1,691	2,174
QCIF (176 x 144)	2,536	3,044	3,805
Sub-QCIF (128 x 96)	3,805	5,073	5,073

## Specifications for Moving Image Shooting

File format	MP4, ASF
Coding system	Video: MPEG4 Voice: AMR, G.726
Extension	3gp, mp4, asf
Title/File name	Automatically set according to the date and time the image was recorded (when shot at 10:00 on November 18, 2008) Title "2008/11/18 10:00" File name "200811181000" (Store in: Phone) "MOL001" (Store in: microSD)
Maximum file size	2 Mbytes (Store in: Phone) Can be limited to the size which can be attached to i-motion mail when shooting. (See page 140)
Mail attachment/Output	Can be attached to mail or output from the FOMA phone by using the microSD card.
Memory capacity	Approx. 111.6 Mbytes (Phone)

## Estimate of recordable time

The recordable time varies depending on shooting environments. Take reference to the recordable time and memory capacity which appear on the Finder display as well.

### ■ Recordable time to P706ij

Image size	File size setting	Movie type set	Recordable time per recording (Approx.)			Total recordable time (Approx.)		
			Image quality			Image quality		
			Super fine	Fine	Normal	Super fine	Fine	Normal
VGA (640 x 480)	Mail restriction (S)	Normal	4 sec	5 sec	8 sec	13 min	17 min	26 min
		Video	4 sec	5 sec	8 sec	13 min	18 min	27 min
		Voice	305 sec			1,145 min		
	Mail restriction (L)	Normal	16 sec	20 sec	30 sec	13 min	17 min	26 min
		Video	16 sec	20 sec	30 sec	13 min	18 min	27 min
		Voice	20 min			1,145 min		
HVGA Wide (640 x 352)	Mail restriction (S)	Normal	5 sec	8 sec	10 sec	17 min	26 min	35 min
		Video	5 sec	8 sec	10 sec	18 min	27 min	36 min
		Voice	305 sec			1,145 min		
	Mail restriction (L)	Normal	20 sec	30 sec	40 sec	17 min	26 min	35 min
		Video	20 sec	30 sec	40 sec	18 min	27 min	36 min
		Voice	20 min			1,145 min		
QVGA (320 x 240)	Mail restriction (S)	Normal	5 sec	10 sec	15 sec	17 min	35 min	53 min
		Video	5 sec	10 sec	15 sec	18 min	36 min	54 min
		Voice	305 sec			1,145 min		
	Mail restriction (L)	Normal	20 sec	39 sec	59 sec	17 min	35 min	53 min
		Video	20 sec	40 sec	60 sec	18 min	36 min	54 min
		Voice	20 min			1,145 min		
QCIF (176 x 144)	Mail restriction (S)	Normal	10 sec	35 sec	69 sec	35 min	129 min	255 min
		Video	10 sec	39 sec	78 sec	36 min	145 min	291 min
		Voice	305 sec			1,145 min		
	Mail restriction (L)	Normal	39 sec	141 sec	279 sec	35 min	129 min	255 min
		Video	40 sec	159 sec	318 sec	36 min	145 min	291 min
		Voice	20 min			1,145 min		
Sub-QCIF (128 x 96)	Mail restriction (S)	Normal	19 sec	62 sec	122 sec	68 min	232 min	455 min
		Video	20 sec	78 sec	156 sec	72 min	291 min	582 min
		Voice	305 sec			1,145 min		
	Mail restriction (L)	Normal	75 sec	254 sec	497 sec	68 min	232 min	455 min
		Video	80 sec	318 sec	10 min	72 min	291 min	582 min
		Voice	20 min			1,145 min		

● The values are the recordable time after deleting the deletable pre-installed data files.

■ Recordable time to microSD card (64 Mbytes)

Image size	File size setting	Movie type set	Recordable time per recording (Approx.)			Total recordable time (Approx.)		
			Image quality			Image quality		
			Super fine	Fine	Normal	Super fine	Fine	Normal
VGA (640 x 480)	Long time	Normal	447 sec	577 sec	14 min	447 sec	577 sec	14 min
		Video	462 sec	10 min	15 min	462 sec	10 min	15 min
		Voice	180 min			624 min		
HVGA Wide (640 x 352)		Normal	577 sec	14 min	18 min	577 sec	14 min	18 min
		Video	10 min	15 min	20 min	10 min	15 min	20 min
		Voice	180 min			624 min		
QVGA (320 x 240)		Normal	577 sec	18 min	26 min	577 sec	18 min	26 min
		Video	15 min	20 min	30 min	15 min	20 min	30 min
		Voice	180 min			624 min		
QCIF (176 x 144)	Normal	18 min	60 min	96 min	18 min	60 min	96 min	
	Video	20 min	80 min	160 min	20 min	80 min	160 min	
	Voice	180 min			624 min			
Sub-QCIF (128 x 96)	Normal	34 min	96 min	137 min	34 min	96 min	137 min	
	Video	40 min	160 min	180 min	40 min	160 min	320 min	
	Voice	180 min			624 min			

## Shooting Still Images

The shot still images are saved to the "Camera" folder of "My picture" in the FOMA phone or to the microSD card.

- See "Storage setting (Store in)" and "Select storage" for selecting a storage location.
- See page 282 for how to display saved still images.

### Shoot a Still Image

#### 1 Press .

- The Camera menu is displayed by  LifeKit ▶ Camera. You can start also by selecting "Photo mode" from the Camera menu.
- You can paste the Camera menu to the desktop. (See page 109)
- When the Top icon is displayed, change the direction of the FOMA phone according to the direction of the icon.

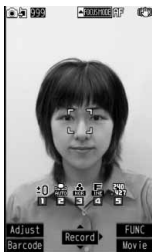



Finder display

#### 2 Press .

- A still image is shot. The Post View display for confirmation appears.
- When "Focus" is set to "Auto", shooting starts after the focus operation.
  - When "Auto save set" is set to "ON", the Post View display does not appear; the still image is automatically saved.

#### 3 Press .

The still image you shot is saved to the "Camera" folder.

- To save the still image as an mirrored image (horizontally reversed), press  (FUNC) and select "Mirror save".
- When "Store in" is set to "microSD", the still image is saved to the folder selected by "Select storage".
- Press  to cancel the shot still image and return to the Finder display.



Post View display

### Continuous Shooting

You can continuously shoot still images. You can set the number of frames, and shooting interval for auto-shooting. (See page 141)

#### 1 ▶ (Movie) ▶ (Cont.)

- The camera starts in the mode you used last time, "Auto", "Manual", or "Auto bracket". To change Continuous Mode, see "Continuous mode" of "Cont. shooting set."
- When the Top icon is displayed, change the direction of the FOMA phone according to the direction of the icon.

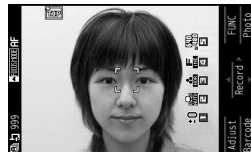



Finder display

## 2 Press (Record).



Continuous shooting starts.

When "Continuous mode" is set to "Manual", press  (Record) the number of times of shooting frames. The Post View display for confirmation appears.

- When "Focus" is set to "Auto", shooting starts after the focus operation.
- To cancel shooting midway, press . If you shoot in the "Auto" or "Auto bracket" mode of "Continuous mode", you can cancel also by pressing  (Quit). You can cancel shooting also by closing the FOMA phone.
- When "Auto save set" is set to "ON", the Post View display does not appear; the still images are automatically saved.

## 3 To select a still image and save it

Select a still image and press  (Detail)  (Save)

- Press  from the detailed display to show the previous or next still image.
- To save the still image as a mirrored image (horizontally reversed), press  (FUNC) and select "Mirror save".

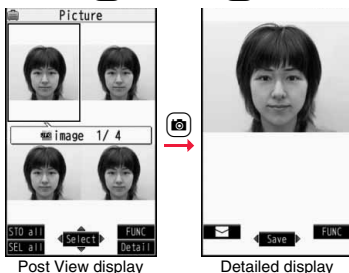

Post View display

Detailed display

To select multiple still images and save them  
Put a check mark for still images to be saved

 (Save)  Save or Mirror save

## To save all still images

 (STO all)  Save or Mirror save



The still images you shot are saved to the "Camera" folder.

- Press  from the Post View display to cancel the shot still images and return to the Finder display.
- When "Store in" is set to "microSD", the still images are saved to the folder set by "Select storage".

## Information

- The image quality may be coarse depending on "Image size" or "Display size".
- When you shoot, the tone selected for "Shutter sound" sounds regardless of the settings such as Manner Mode. The sound volume for shutter tone cannot be changed.
- Even when a mail message comes in while shooting, the shooting operation continues. Though unread message icon is displayed, the Mail Receiving display is not displayed.
- If you end the camera function by using Multitask while shooting, unsaved still images are deleted.
- When shooting, hold the FOMA phone securely to avoid blurred images.
- While you are shooting in Photo Mode or "Manual" of Continuous Mode, the Call/Charging indicator flickers. In "Auto"/"Auto bracket" of Continuous Mode, it lights.

## Function Menu of the Post View Display in Photo Mode/ Detailed Display in Continuous Mode

Function menu	Operation/Explanation
Save	See page 135 and page 136.
Mirror save	See page 135 and page 136.
Attach to mail	You can save the still image you shot and attach it to an i-mode mail message. Go to step 2 on page 174. <ul style="list-style-type: none"> <li>• You can compose an i-mode mail message also by pressing  .</li> </ul>

Function menu	Operation/Explanation
<b>Set display</b>	You can paste the still image to the Stand-by display and others for displaying. This is available only in Photo Mode. Go to "Set display" on page 283. <ul style="list-style-type: none"> <li>Even when "Store in" is set to "microSD", the still image is saved to the FOMA phone.</li> </ul>
<b>Change frame</b>	You can replace the frame added to the shot still image with a new one. This is available only in Photo Mode. <b>▶ Select a frame.</b> <ul style="list-style-type: none"> <li>Press  to bring up the previous or next frame.</li> <li>To reselect a frame, press  (Cancel).</li> <li> (Set)</li> <li>You cannot release the frame.</li> </ul>
<b>Normal display/ Mirror display</b>	You can switch between a correct image and a mirrored image (horizontally reversed).
<b>Store in</b>	See page 140.
<b>Display size</b>	See page 141.
<b>File restriction</b>	See page 142.
<b>Icon</b>	See page 141.
<b>Cancel</b>	You do not save the shot still image.

### Function Menu of the Post View Display in Continuous Mode

- If you highlight a still image from the Post View display and press (Select), "✓" is added. Press (Select) again to release the selection.

Function menu	Operation/Explanation
<b>Save</b>	See page 136.
<b>Store all/animat'n</b>	You can save all the shot still images to store as an original animation. <b>▶ Save</b> <ul style="list-style-type: none"> <li>To save as a mirrored image (horizontally reversed), select "Mirror save".</li> </ul> <b>▶ &lt;New&gt;</b>

Function menu	Operation/Explanation
<b>Store in</b>	See page 140.
<b>Normal display/ Mirror display</b>	You can switch between a correct image and a mirrored image (horizontally reversed).
<b>File restriction</b>	You can set the file restrictions on the image on the Post View display. <b>▶ File unrestricted or File restricted</b> <ul style="list-style-type: none"> <li>See page 142 for the file restrictions.</li> </ul>
<b>Cancel</b>	You do not save the shot still images.

### Information

#### <Store all/animat'n>

- When "Store in" is set to "microSD", this function is not available.
- If you have shot a single still image only, this function is not available.

### <Moving Image Shoot>

## Shooting Moving Images

The shot moving images are saved to the "Camera" folder of "motion" in the FOMA phone or to the microSD card.

- For selecting a storage location, see "Storage setting (Store in)" and "Select storage".
- See page 290 for playing back the saved moving images.



- The Camera menu is displayed by  
 (MENU) ▶ LifeKit ▶ Camera.  
 You can start also by selecting "Movie mode" from the Camera menu.
- You can paste the Camera menu to the desktop. (See page 109)
- When the Top icon is displayed, change the direction of the FOMA phone according to the direction of the icon.



Finder display

## 2 Press (Record).

Recording starts.

- When “Focus” is set to “Auto”, shooting starts after the focus operation. While shooting, the subject is automatically focused regardless of the setting of “Focus”.

## 3 Press (Stop).

Recording ends. The Post View display for confirmation appears.

- Recording automatically ends when a call comes in, the low battery alarm sounds, or the FOMA phone is closed during recording.
- When “Auto save set” is set to “ON”, or “File size setting” is set to “Long time”, the Post View display does not appear; the moving image is automatically saved. When “Store in” is set to “microSD”, the moving image is saved to the folder set by “Select storage”.

## 4 Press (Save).

The moving image you shot is saved to the “Camera” folder.

- Press  to cancel the shot moving image and return to the Finder display.



Post View display

### If recording ends or the image quality deteriorates while shooting

When you use a microSD card that you repeatedly save/delete data files to/from, the writing speed slows down, recording might end midway or the image quality might deteriorate.

Do the following operations to improve such symptoms:

1. **Copy all the data files from the microSD card onto your personal computer as they are.**
  - When your personal computer is set so as to hide folders and files, change the settings to display those folders and files, and then operate. For how to change the settings, refer to the operating manual or Help on the personal computer you use.
  - Do not change the names of folders and files copied to the personal computer.
2. **Use the personal computer to delete all the data files on the microSD card.**
  - Do not format the microSD card. The data files might not be played back.
3. **Copy the data files copied in step 1 back to the microSD card.**
  - Be sure to copy them back to the same microSD card. Even if you save the copyrighted data files on another microSD card, you cannot play them back.



### Information

- The shutter tone set by “Shutter sound” sounds when shooting starts and ends regardless of the settings such as Manner Mode. The sound volume for shutter tone cannot be changed.
- If you do key operations while recording, the operation sound may be picked up.
- The Call/Charging indicator flickers during recording.
- When you switch the subject you are shooting to a subject with a difference in perspective, it takes time to focus on the new subject.
- When you have difficulty focusing on a subject, switch to another subject. Then the subject might come into focus.
- The operating speed of Autofocus is slowed down in a dark place.

### Function Menu of the Post View Display in Movie Mode

Function menu	Operation/Explanation
Play	See page 290.
Save	See page 138.



Function menu	Operation/Explanation
<b>Attach to mail</b>	You can save the recorded moving image and attach it to an i-mode mail message. Go to step 2 on page 174. ● You can compose an i-mode mail message also by pressing   .
<b>Set as stand-by</b>	You can save the recorded moving image and set it for the Stand-by display.
<b>Store in</b>	See page 140.
<b>Display size</b>	See page 141.
<b>File restriction</b>	See page 142.
<b>Icon</b>	See page 141.
<b>Cancel</b>	You do not save the recorded moving image.

### Information

#### <Set as stand-by>

- Some moving images might not be displayed correctly.
- See page 99 for playback of the moving image set for the Stand-by display.

## Changing Settings for Shooting Images

You can set the camera when shooting images.

### Use Zoom

You can display the image through the camera in “Wide” or “Tele”.

The maximum magnification for each size is as follows:

Camera mode	Size	Level of zoom	The maximum magnifications (Approx.)
Photo	2M (1600 x 1200)	1 level	1.0 times
	1.4M Wide (1600 x 900)	1 level	1.0 times
	1M (1280 x 960)	6 levels	1.2 times
	VGA (640 x 480)	11 levels	1.8 times
	Stand-by (240 x 427)	31 levels	3.7 times
	CIF (352 x 288)	31 levels	3.4 times
	QVGA (240 x 320)	31 levels	5.0 times
	QCIF (176 x 144)	31 levels	6.8 times
	Sub-QCIF (128 x 96)	31 levels	9.3 times

Camera mode	Size	Level of zoom	The maximum magnifications (Approx.)
Continuous	VGA (640 x 480)	6 levels	2.5 times
	CIF (352 x 288)	31 levels	3.4 times
	QVGA (240 x 320)	31 levels	5.0 times
	QCIF (176 x 144)	31 levels	6.8 times
	Sub-QCIF (128 x 96)	31 levels	9.3 times
Movie	VGA (640 x 480)	6 levels	2.5 times
	HVGA Wide (640 x 352)	6 levels	2.5 times
	QVGA (320 x 240)	31 levels	3.7 times
	QCIF (176 x 144)	31 levels	6.8 times
	Sub-QCIF (128 x 96)	31 levels	9.3 times

### 1 Finder display ▶ Use to adjust the magnification.

### Information

- The image quality may slightly change when you select “Wide” or “Tele”.
- “Tele” is released in the following cases:
  - When you press  to end the camera
  - When a size is changed
  - When camera mode is switched

### Use Autofocus

You can shoot with the camera after confirming the focus conditions.

You can use Autofocus even if “Focus” is set to “Close-up” or “Landscape”.

- Autofocus works when you shoot a subject about 10 cm or more away from it.

### 1 Finder display ▶

When the subject is focused, a confirmation tone sounds, then the frame becomes green and the focus is locked.

When the subject is not focused, the frame becomes red.

- Press **(CLR)** to focus again.

### Information

- If “Movie type set” is set to “Voice” in Movie Mode, you cannot use Autofocus.

# Setting Image Size and Image Quality

## Function Menu of the Finder Display

Function menu	Operation/Explanation
<b>CHG camera-mode</b>	<p>▶ <b>Select a mode.</b></p> <ul style="list-style-type: none"> <li>When you select "Continuous mode", the camera starts in the mode you used last time, "Auto", "Manual", or "Auto bracket".</li> </ul>
<b>Image size</b>	<p>▶ <b>Select an image size.</b></p> <ul style="list-style-type: none"> <li>When you shoot a photo for sending during a voice call, you can select only "QCIF (176 x 144)" and "Sub-QCIF (128 x 96)".</li> </ul>
<b>File size setting</b> [Movie Mode only]	<p>▶ <b>Select an item.</b></p> <p><b>Mail restrict'n (S)</b> . . . You can shoot up to 500 Kbytes.</p> <p><b>Mail restrict'n (L)</b> . . . You can shoot up to 2 Mbytes.</p> <p><b>Long time</b> . . . . . You can shoot for a long time. The moving image is saved to the microSD card.</p>
<b>Image quality</b>	<p>You can set the image quality for saving.</p> <p>▶ <b>Select an image quality.</b></p>
<b>Camera settings (Brightness)</b>	<p>You can adjust to -3 (dark) through +3 (bright).</p> <p>▶ <b>Brightness</b> ▶ <b>Select a brightness level.</b></p>
At Camera start-up	±0
<b>Camera settings (White balance)</b>	<p>You can adjust the coloring of the image on the Finder display to create a natural color tone.</p> <p>▶ <b>White balance</b> ▶ <b>Select an item.</b></p> <p><b>Auto</b> . . . . . For adjusting white balance automatically</p> <p><b>Fine</b> . . . . . For shooting outdoors in fine weather</p> <p><b>Cloudy</b> . . . . . For shooting in cloudy weather or in the shade</p> <p><b>Light bulb</b> . . . . . For shooting under incandescent light</p> <p><b>Fluorescent light</b> . . . For shooting under fluorescent light</p>
At Camera start-up	Auto

Function menu	Operation/Explanation
<b>Camera settings (Color mode set)</b>	<p>▶ <b>Color mode set</b> ▶ <b>Select a color mode.</b></p> <p><b>Normal</b> . . . . . For shooting in normal color</p> <p><b>Sepia</b> . . . . . For shooting in sepia color</p> <p><b>Monochrome</b> . . . For shooting in monochrome</p>
At Camera start-up	Normal
<b>Camera settings (Photo mode)</b>	<p>You can set a photo mode suitable for the place.</p> <p>▶ <b>Photo mode</b> ▶ <b>Select a photo mode.</b></p> <p><b>Normal</b> . . . . . Standard mode</p> <p><b>Portrait</b> . . . . . For shooting portraits</p> <p><b>Sports</b> . . . . . For shooting moving subjects such as athletes</p> <p><b>Food</b> . . . . . For shooting dishes</p> <p><b>Scenery</b> . . . . . For shooting scenery</p> <p><b>Night mode</b> . . . For shooting in dark places such as in nighttime</p> <p><b>Backlight</b> . . . . For shooting against the sun (from behind)</p>
At Camera start-up	Normal
<b>Camera settings (Focus)</b>	<p>You can set the focus of the camera.</p> <p>▶ <b>Focus</b> ▶ <b>Select an item.</b></p> <p><b>Auto</b> . . . . . For focusing automatically before shooting (See page 139)</p> <p><b>Close-up</b> . . . . . For focusing on a subject in a short distance</p> <p><b>Landscape</b> . . . . For focusing on a landscape in a long distance</p>
At Camera start-up	Auto
<b>Camera settings (Shutter sound)</b>	<p>You can set a shutter sound. You can set a shutter sound each for Photo Mode (Continuous Mode) and Movie Mode.</p> <p>▶ <b>Shutter sound</b> ▶ <b>Select a shutter sound.</b></p> <ul style="list-style-type: none"> <li>While you are selecting, the shutter tone sounds for confirmation.</li> </ul>
<b>Camera settings (Flicker correction)</b>	<p>You can suppress blur on the Finder display for shooting.</p> <p>▶ <b>Flicker correction</b> ▶ <b>Auto, Mode 1 (50Hz) or Mode 2 (60Hz)</b></p>
<b>Storage setting (Store in)</b>	<p>You can set the storage location for the still or moving images you shot.</p> <p>▶ <b>Store in</b> ▶ <b>Phone or microSD</b></p>

Function menu	Operation/Explanation
<b>Storage setting (Auto save set)</b>	You can set whether to automatically save the image after shooting. When "Store in" is "Phone", the image is saved to the "Camera" folder. When "Store in" is "microSD", the image is saved to the folder set by "Select storage". ▶ <b>Auto save set</b> ▶ <b>ON or OFF</b>
<b>Storage setting (File restriction)</b>	See page 142.
<b>Img. stabilizer (Photo Mode only)</b>	You can correct camera shake for when shooting with the camera. ▶ <b>Auto or OFF</b>
<b>Auto timer</b>	See page 143.
<b>Shooting effect (Shoot with frame)</b>	You can shoot a still image with a frame. ▶ <b>Shoot with frame</b> ▶ <b>ON or OFF</b> ▶ <b>Select a frame.</b>
At Camera start-up OFF	
[Photo Mode only]	
<b>Shooting effect (Cushy mark)</b>	You can shoot a person's face with a cushy mark pasted. The cushy mark is automatically pasted in an appropriate position. ▶ <b>Cushy mark</b> ▶ <b>ON or OFF</b> ▶ <b>Select a cushy mark.</b>
At Camera start-up OFF	
[Photo/Movie Mode]	
<b>Cont. shooting set. (Continuous mode)</b>	▶ <b>Continuous mode</b> ▶ <b>Select a mode.</b>
[Continuous Mode only]	<b>Auto</b> . . . . . Shoots automatically at an interval and with the number of frames as specified by "Shot interval" and "Shot number". <b>Manual</b> . . . . . Shoots one by one manually with the number of frames specified by "Shot number". <b>Auto bracket</b> . . . Shoots automatically nine still images at an interval of about 0.3 second while changing the brightness and color tone one by one. ● Select "Manual" to display the number of frames for continuous shooting.

Function menu	Operation/Explanation
<b>Cont. shooting set. (Shot interval)</b>	▶ <b>Shot interval</b> ▶ <b>Select a shooting interval.</b> ● You can set this only in "Auto" of Continuous Mode. [Continuous Mode only]
<b>Cont. shooting set. (Shot number)</b>	▶ <b>Shot number</b> ▶ <b>Enter the number of photos.</b> ● When "Image size" is set to "VGA (640 x 480)" or "CIF (352 x 288)", you cannot change "Shot number". ● You can set this only in "Auto" or "Manual" of Continuous Mode. [Continuous Mode only]
<b>Movie type set</b>	You can select whether to record both the video and voice, or one of them when you shoot the moving image. ▶ <b>Normal, Video, or Voice</b>
At Camera start-up Normal	
[Movie Mode only]	
<b>Display size</b>	You can set whether to display a moving image or still image in the original size (Actual size) or to fit to the screen size on the Finder display. ▶ <b>Actual size or Fit in display</b>
<b>Common replay mode</b>	You can set a shooting size appropriate for attaching to i-mode mail. ▶ <b>YES</b> ● Image Size is set to "QCIF", File Size Setting is set to "Mail restrict'n (S)", and Image Quality (Movie Mode) is set to "Normal".
[Movie Mode only]	
<b>Icon</b>	You can set whether to display icons. ▶ <b>ON or OFF</b>
<b>Memory info</b>	You can display the used memory space (estimate)/number of stored items.

### Information

#### <File size setting>

- When "File size setting" is set to "Long time", "Store in" is set to "microSD".

**Information****<Camera settings>**

- Note that the image may blur in Night Mode because the exposure takes a longer time.
- If you set "Flicker correction" to "Auto", it may take a while to automatically adjust the image quality. In this case, switch to Mode 1 or Mode 2 according to the power frequency provided in the shooting location.
- Even if you change the setting of "Brightness", "White balance", "Color mode set", or "Focus", the setting appropriate for each "Photo mode" applies when you change "Photo mode".

**<Storage setting>**

- See "Select storage" for how to set a storage location on the microSD card.
- If you change "File size setting" to "Long time", "Store in" is set to "microSD" and "Storage setting" cannot be operated.
- When "Auto save set" is set to "ON", the image is saved to the latest folder if "Select storage" is not set or the folder set as a destination folder is deleted.

**<Img. stabilizer>**

- This function is only for decreasing the degree of camera shake, so its effect differs depending on the subject or condition.
- Image Stabilizer might not work effectively in the following cases:
  - When the camera shakes to a great extent
  - When zooming is in use
  - When shooting moving subjects
- When "Photo mode" of "Camera settings" is set to "Sports" or "Night mode", "Img. stabilizer" becomes invalid.
- Residual images might remain in the area where the subject is moving, or noise might be found in overall area. In that case, set this function to "OFF".
- When this function is activated, the processing after shooting might be about two seconds longer due to the processing by Image Stabilizer.

**<Shooting effect>**

- When "Image size" is set to larger than "VGA (640 x 480)", you cannot shoot with a frame.
- You cannot save the still image shot with a frame as the mirrored image.
- When "Image size" is set to larger than "VGA (640 x 480)", you cannot paste cushy marks in Photo Mode.

**Information****<Cont. shooting set.>**

- The number of shots that can be set differs depending on the image size. The number of shots that can be set is as follows:
  - VGA (640 x 480): 4
  - CIF (352 x 288): 4
  - QVGA (240 x 320): 5 through 10
  - QCIF (176 x 144): 5 through 20
  - Sub-QCIF (128 x 96): 5 through 20

**<Display size>**

- When "Image size" is set to a size larger than "QVGA (320 x 240)", "Fit in display" always applies, so you cannot change the setting.
- The setting for the Finder display is reflected in the Post View display; however the setting for the Post View display is not reflected in the Finder display.

**<Common replay mode>**

- You cannot operate when you set "File size setting" to "Long time".

**File Restriction**

You can set whether to allow recipients of your mail messages to redistribute (attach, forward), from their FOMA phones, the files such as still/moving images you shot and attached. When you set to "File restricted", the recipients cannot redistribute the files.

**1** Finder display   Storage setting  
▶ File restriction

or

Post View display in Photo Mode, Movie Mode or Photo sending/Detailed display in Continuous Mode  
▶   File restriction

**2** File unrestricted or File restricted

**Information**

- Even when you set "File restriction" to "File restricted", the still or moving images can be output from the destination mobile phone by transmitting the images using infrared data exchange or by copying them to the microSD card.

## Information

- After saving, you can use "File restriction" on page 284 to change the settings.
- When you set "File size setting" to "Long time" in Movie Mode, "File restriction" becomes "File unrestricted".

## Auto Timer

At Camera start-up    OFF

**1** Finder display ▶ (FUNC) ▶ Auto timer ▶ ON or OFF  
▶ Enter a delay time (seconds).

- Enter from "01" through "15", in two digits.

### When Auto Timer is set to "ON"

appears on the Finder display.

If you press (Record), a confirmation tone sounds and blinks. The Call/Charging indicator flickers every about 1 second until about 5 seconds before shooting. From about 5 seconds before shooting, the Call/Charging indicator flickers every about 0.5 second, and the confirmation tone sounds every about 1 second. Shooting takes place after the set delay time has elapsed.

- To cancel shooting, press (Quit) or (CLR) while the Call/Charging indicator is flickering. Even if you cancel shooting, "Auto timer" stays set to "ON".
- You can shoot immediately by pressing (Record) before the delay time has elapsed.
- When you shoot, a confirmation tone sounds regardless of the settings such as Manner Mode. You cannot change the sound volume for the confirmation tone.

## Information

- You cannot use Auto Timer in "Manual" of Continuous Mode.
- Auto Timer is set to "OFF" when shooting ends.

## <Bar Code Reader>

# Using Bar Code Reader

You can use the camera to scan JAN codes or QR codes and store them as data files.

From the scanned data, you can make calls, compose i-mode mail messages, and access Internet web pages, and so on.

### ■ When scanning with Bar Code Reader

- Take the character strings as large as possible within the guide frame.
- Autofocus works when you scan a code about 10 cm or more away from it. When you scan a code in the out-of-focus state, the recognition rate lowers.
- Scan so that the camera is in parallel with the code.

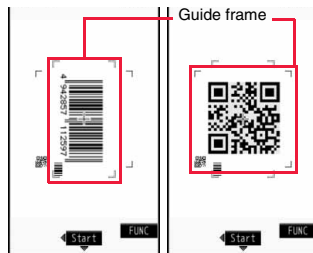

Scanning Code display

### ■ JAN Code

JAN Code is a bar code that denotes numerals with the vertical bars of a different width.

You can scan 8-digit (JAN8) and 13-digit (JAN13) JAN codes.

- "4942857112597" is displayed when you scan this bar code with the FOMA phone.



### ■ QR Code

QR Code is one of the 2-dimensional codes that denotes data in the vertical and horizontal directions.

Kanji, katakana, alphanumeric characters, and pictographs are displayed when you scan it. Some QR codes have image or melody information.

- "株式会社NTTドコモ (NTT DOCOMO, INC.)" is displayed when you scan this QR code with the FOMA phone.



## Scan a Code

At Bar Code Reader start-up	Brightness: ±0 Zoom: Magnified view
-----------------------------	--

You can store up to 5 scanned codes.

You can scan up to 16 divided QR codes.



### 1 LifeKit Scan code

The Bar Code Reader menu is displayed.

- You can paste the Bar Code Reader menu to the desktop. (See page 109)





### 2 Fit a code to be scanned to the guide frame and press .

When the focus is locked, a confirmation tone sounds and the cross mark becomes green.

- Press  and select "Brightness"; then you can adjust brightness to -3 (dark) through +3 (bright).
- Press  to show the reduced display, and press  to return to the former display.

### 3 Press .

The code is scanned. (The shutter tone does not sound.)

- To cancel scanning, press  or .
- When scanning is completed, the scanning completion tone sounds and the Call/Charging indicator lights. The sound level is fixed and cannot be changed. However, the tone does not sound in Manner Mode or while "Phone" of "Ring volume" is set to "Silent".
- "🎵" is displayed for melody files and "🔊" or "🔇" is displayed for incompatible or damaged files.
- While you are entering (editing) characters, the Scanned Code Result display does not appear; the Text Data Confirmation display of the scanned code appears. To enter the scanned code, press . To discard it, press  or . The characters that cannot be displayed are replaced by half-pitch spaces. When the code containing no text data has been scanned, the code is not correctly displayed.
- If scanning is not completed in a certain period, the scanning is suspended and the Scanning Code display returns.
- When the scanned code is part of divided QR codes, select "OK" to repeat step 2 and step 3 for scanning the rest of codes.

### 4 Save result

The scanned data is stored.

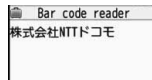





Scanned Code Result display

#### Information

- You cannot scan bar codes or 2-dimensional codes other than JAN codes or QR codes.
- Scanning may take a long time. Hold the FOMA phone securely with your hands during scanning.
- You may not be able to scan codes correctly depending on scratch, dirt, damage, the quality of printed material, light reflection, or QR code version.
- You cannot scan some codes depending on the type or size.

#### Function Menu of the Scanned Code Result Display

Function menu	Operation/Explanation
Save result	See page 144.
Display list	You can bring up the Bar Code Reader list when one or more files are stored.
Internet	You can connect to the highlighted URL via i-mode or Full Browser. <b>▶ i-mode or Full Browser ▶ YES</b> <ul style="list-style-type: none"><li>You can connect to the URL also by highlighting the URL and pressing .</li></ul>
Compose message	You can compose an i-mode mail message to send to the highlighted mail address. Go to step 3 on page 174. <ul style="list-style-type: none"><li>You can compose it also by highlighting the mail address and pressing .</li><li>When you select "Compose message" from the Scanned Code Result display, the data on the Scanned Code Result display is entered into the address, subject, and text field.</li></ul>

Function menu	Operation/Explanation
Dialing	<p>You can make a voice call or videophone call to the highlighted phone number.</p> <p>▶ <b>Select a dialing type.</b></p> <ul style="list-style-type: none"> <li>● When you select "Select image", select an image to send to the other party during the videophone call.</li> <li>● When you select "Compose SMS", you can compose an SMS message to send to the phone number set as the destination address. Go to step 3 on page 214.</li> <li>● You can make a call also by highlighting the phone number and pressing  (Select).</li> </ul> <p>▶ <b>Dial</b></p> <ul style="list-style-type: none"> <li>● To make an international call, select "Int'l dial assist". (See page 59)</li> <li>● To set Caller ID Notification, select "Notify caller ID". (See step 2 on page 56)</li> </ul>
Add to phonebook	See page 82.
Add bookmark	<p>You can bookmark the site name and URL.</p> <p>▶ <b>YES</b></p> <ul style="list-style-type: none"> <li>● Select "Page title" to edit the title.</li> </ul> <p>▶ <b>OK ▶ Select a destination folder.</b></p>
Save image	<p>You can save the scanned image data to set to the Stand-by display or other displays.</p> <p>▶ <b>Select a destination folder.</b></p> <p>Go to step 3 on page 160.</p> <ul style="list-style-type: none"> <li>● See page 163 when images are stored to the maximum.</li> </ul>
Save melody	<p>You can save the scanned melody data to set it as a ring tone or other tones.</p> <p>▶ <b>YES ▶ Select a destination folder.</b></p> <p>Go to step 2 on page 160.</p> <ul style="list-style-type: none"> <li>● Select "" to play back the melody.</li> <li>● See page 163 when melodies are stored to the maximum.</li> </ul>
Save ToruCa	<p>You can save the scanned ToruCa file.</p> <p>▶ <b>Select a destination folder.</b></p> <ul style="list-style-type: none"> <li>● Select "" to display the ToruCa file.</li> <li>● See page 163 when ToruCa files are stored to maximum.</li> </ul>

Function menu	Operation/Explanation
Start  <b>oppli</b>	<p>You can start up i-oppli from the scanned data.</p> <p>▶ <b>YES</b></p>
Copy	<p>▶ <b>Select a start point for copying</b></p> <p>▶ <b>Select an end point for copying.</b></p> <ul style="list-style-type: none"> <li>● You can copy codes of up to 5,000 full-pitch/10,000 half-pitch characters.</li> <li>● See page 382 for pasting copied characters.</li> </ul>

### Information

#### <Internet>

- URL can be displayed in up to 512 half-pitch characters by Bar Code Reader and up to 256 half-pitch characters by Text Reader.

#### <Compose message>

- If the scanned data contains nonenterable characters, you cannot enter it as a mail address, and those characters may become spaces in the text field.

#### <Dialing>

- You cannot make emergency calls by scanning "110", "119" or "118".

#### <Add bookmark>

- You can display up to 512 half-pitch characters for a URL and can store up to 256 characters from the beginning.

#### <Save image>

- The file name and title for the saved image are "imageXXX" (XXX are numerals).

#### <Save melody>



- The file name for the saved melody is "melodyXXX" (XXX are numerals).
- For the melody with no title, the file name is displayed as the title.
- When playing back the melody, it is played back at the sound volume set for "Phone" of "Ring volume".

## Display the Saved Data List

1  ▶ LifeKit ▶ Bar code reader  
▶ **Saved data**

The titles for stored data are displayed from the latest one.

- Select a title to show the Scanned Code Result display.

Bar code reader	
	20081118 1045 0000
	20081118 0944 0000

Bar Code Reader list

## Information

- The titles for the scanned data are as follows:  
(Example) When the scanned data is saved at 10:00 on November 18, 2008;  
Title name: 20081118\_1000\_0000
  - If you store multiple data items for the same date and time, the lower four-digit numbers increase up to "9999".

## Function Menu of the Bar Code Reader List

Function menu	Operation/Explanation
<b>Edit title</b>	<b>▶ Enter a title.</b> You can enter up to 9 full-pitch/18 half-pitch characters.
<b>Result</b>	You can bring up the Scanned Code Result display for stored data.
<b>Delete (Delete this)</b>	<b>▶ Delete this ▶ YES</b>
<b>Delete (Delete all)</b>	<b>▶ Delete all ▶ Enter your Terminal Security Code ▶ YES</b>

## <Text Reader>

### Using Text Reader

You can use the camera to scan alphanumeric characters such as printed phone numbers, mail addresses, and URLs, and store them as text information. Use the text information to make calls, compose i-mode mail, connect to the Internet, and so on.

#### ■ When scanning with Text Reader

- Take the character strings as large as possible within the guide frame.
- Autofocus works when you scan characters about 10 cm or more away from them. When you scan characters in the out-of-focus state, the recognition rate lowers.
- Scan the character string with the camera set in parallel.

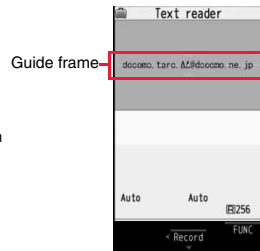

Scanning Text display

### Scan Text

At Text Reader start-up Zoom: Magnified view

You can store eight scanned data files of up to 256 half-pitch characters per item. The number of characters you can scan at a time is up to 50 half-pitch characters, and you can scan the increased characters in parts.

#### 1 ▶ LifeKit ▶ Text reader ▶ Scan text

The Text Reader menu is displayed.

- You can paste the Text Reader menu to the desktop. (See page 109)

#### 2 Fit the characters to be scanned to the guide frame and press .

When the focus is locked, a confirmation tone sounds and the guide frame becomes green.

- Press to show the reduced display, and press to return to the former display.



### 3 Press (Record).

The characters are scanned. (The shutter tone does not sound.)

- To cancel scanning, press .
- When scanning is completed, the scanning completion tone sounds and the Call/Charging indicator lights. The sound level is fixed and cannot be changed. However, the tone does not sound in Manner Mode or while "Phone" of "Ring volume" is set to "Silent".

### 4 Confirm the scanned result.



The scanned characters are underlined.

Confirm the scanned characters for mistakes.

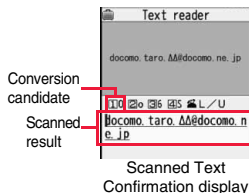
- Press  to restart scanning.
- To store the characters without correcting, go to step 7.



### 5 Press to highlight a character to be corrected ▶ Press the number of the conversion candidate.

- Conversion candidates are displayed up to four kinds for each character.
- When you want to correct a character to other than the conversion candidate, highlight the character to be corrected and press  (Mode), then enter a character after switching to "Alphabet entry mode" or "Numeric entry mode". However you cannot enter characters such as ".ne.jp" or ".co.jp" by pressing .

### 6 Press (Set).

The scanned characters are set.

- To link characters, repeat step 2 through step 6.
- To release the set characters, press .

### 7 (FUNC) ▶ Store

The scanned characters are stored.

- When scanned text contains "tel", "@", or "http://", you can execute Phone To or Web To function by selecting the text. (See page 164) You can select only first item even if multiple items are found.
- Press  (Overwrite) to overwrite the scanned characters and activate Text Reader. Go to step 2.

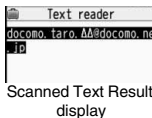

### Information

- Hold the FOMA phone securely with your hands during scanning so that you can scan characters correctly.
- Characters you can scan are alphabet letters (uppercase and lowercase), numerals, and symbols (#, &, (, ), -, ., /, :, @, [, ], \_, ~, ?, =, %, and +). You cannot scan kanji and hiragana characters. You might not be able to scan those correctly depending on the surroundings such as lighting.
- You cannot scan handwritten characters correctly.
- You might not be able to scan the following:  
Characters received by a FAX/Copied characters/Designed characters/Characters having no certain space between characters/Characters difficult to identify from the background.

### Display the Saved Data List

#### 1 ▶ LifeKit ▶ Text reader ▶ Saved data

Up to 22 half-pitch characters are displayed for each stored data.

- Select a data item to show the Scanned Text Result display.

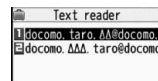



### Function Menu of the Scanning Text Display/Scanned Text Confirmation Display

Function menu	Operation/Explanation
Store	See page 147.
Edit	You can edit and store the scanned character string. ▶ Edit the text.

Function menu	Operation/Explanation
<b>Recognition mode</b>	You can set this mode according to the type of the character string you want to scan. ▶ <b>Select an item.</b>
At Text Reader start-up	<p><b>Auto setting</b> . . . . . Automatically recognizes the type of characters.</p> <p><b>URL</b> . . . . . Select this when you scan a URL. "http://" or "https://" is automatically entered to the head of the character string when it is stored.</p> <p><b>Mail address</b> . . . . . Select this when you scan a mail address.</p> <p><b>Phone number</b> . . . . . Select this when you scan a phone number.</p> <p><b>Number</b> . . . . . Select this when you scan numerals.</p> <p><b>Free character</b> . . . . . Select this when you scan alphabetic characters that are not especially specified.</p>
Auto setting	
<b>NEGA/POSI mode</b>	You can set this mode to fit to the printing conditions of the character string you want to scan. ▶ <b>Select an item.</b>
At Text Reader start-up	<p><b>Auto setting</b> . . . . . Automatically recognizes printing conditions.</p> <p><b>Positive fix</b> . . . . . Select this when deep color characters are printed over faint color ground.</p> <p><b>Negative fix</b> . . . . . Select this when faint color characters are printed over deep color ground.</p>
Auto setting	

### Function Menu of the Scanned Text Result Display/Text Reader List

Function menu	Operation/Explanation
<b>Edit</b>	▶ <b>Edit the text.</b>
<b>Internet</b>	See page 144.
<b>Compose message</b>	You can compose an i-mode mail message to send to the scanned mail address as a destination address. Go to step 3 on page 174. ● You can compose an i-mode mail message also by pressing  (  ).
<b>Dialing</b>	See page 145.

Function menu	Operation/Explanation
<b>Store mail add.</b>	See page 82.
<b>Store phone No.</b>	See page 82.
<b>Add bookmark</b>	You can bookmark the URL you have scanned. ▶ <b>OK</b> ● Select "Page title" to edit the title. ▶ <b>Select a destination folder.</b>
<b>Search phonebook</b>	You can search for Phonebook entries using the scanned phone number or mail address. ▶ <b>Select a search method</b> ▶  The Phonebook list that corresponds to the phone number or mail address is displayed.
<b>Display detail/Display list</b>	You can switch between the Scanned Text Result display and Text Reader list.
<b>Delete (Delete this)</b>	▶ <b>Delete this</b> ▶ <b>YES</b>
<b>Delete (Delete all)</b>	▶ <b>Delete all</b> ▶ <b>Enter your Terminal Security Code</b> ▶ <b>YES</b>

# i-mode/i-motion/i-Channel

What is i-mode? .....	150	<b>Setting Functions of i-mode</b>	
<b>Displaying Sites</b>		Setting i-mode .....	<i-mode Settings> 165
Accessing Sites .....	<Menu> 150	Setting Connection Timeout .....	<Set Connection Timeout> 166
How to View/to Operate Sites .....	151	Changing a Host from i-mode (ISP Connection Communication)	
Displaying Most Recently Accessed Site .....	<Last URL> 154	.....	<Host Selection> 166
Using My Menu .....	<My Menu> 154	<b>Using Certificates</b>	
Changing i-mode Password .....	<Change i-mode Password> 155	Operating SSL Certificates .....	<SSL Certificate> 167
Displaying Internet Web Pages .....	<Enter URL> 155	Setting FirstPass .....	<Client Certificate> 167
Bookmarking Web Pages or Sites for Quick Access		Changing a CA Center .....	<Certificate Host> 169
.....	<Bookmark> 156	<b>Using i-motion</b>	
Saving Site Contents .....	<Screen Memo> 158	What is i-motion? .....	170
<b>Downloading Images or Melodies from Sites</b>		Obtaining i-motion Movies from Sites	
Downloading Files or Data Items from Sites .....	160	.....	<Obtain i-motion Movie> 170
<b>Convenient Functions of i-mode</b>		Setting Automatic Replay of i-motion Movies	
Operations from Highlighted Information .....	164	.....	< i-motion Auto-play> 171
		<b>Using i-Channel</b>	
		What is i-Channel? .....	171
		Using i-Channel .....	172
		Setting How Ticker is Displayed .....	172

## What is i-mode?

i-mode is the service that makes use of the display of the FOMA phone supporting i-mode (i-mode phone) to enable you to use online services such as site (program) access, Internet access, and i-mode mail.

- i-mode is a pay service that is available on a subscription basis.
- For details on i-mode, refer to the "Mobile Phone User's Guide [i-mode] FOMA version".

### ■ Before Using i-mode

- Contents of sites (programs) and web pages (Internet web pages) are generally protected by copyrights law. Data such as text and images that you obtained to the i-mode phone from sites (programs) and Internet web pages can be used for personal entertainment but cannot be used in whole or in part, as it is or after modification, for commercial purposes or sent as e-mail attachments or output from your i-mode phone to other devices, unless you have permission from the copyright holders.
- If you replace the UIM with another one or turn on the power with the UIM not inserted, you cannot display/play back files depending on the model, such as still images/moving images/melodies obtained from sites, attached files (still images/moving images/melodies and other files) sent/received by mail, screen memos, or Messages R/F.
- When the file whose display and/or playback is restricted by the UIM is set for the Stand-by display or specified ring tone, the FOMA phone works with the default contents when you replace the existing UIM with new one or turn on the power with the UIM not inserted.

< Menu

## Accessing Sites

You can use a variety of services offered by IPs (Information Providers). From the display of the FOMA phone, you can check your bank balance, reserve tickets, and do similar tasks. (IPs offer different types of services. Some of them need to be applied for separately.)

## 1 Menu

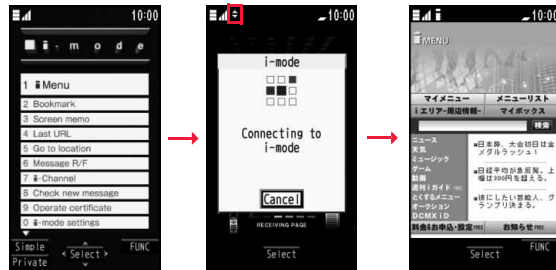

i-mode menu

While you are online, "i-mode" blinks.

- "i-mode" blinks while you are using the i-mode service (during i-mode standby).
- To cancel during the connection, select "Cancel". To cancel while obtaining a page, press [Quit].
- To end i-mode, press [End] and select "YES" while the site is displayed. "i-mode" goes off and i-mode ends. It may take longer to end i-mode.

## 2 Select an item (link).

Repeat selecting items (links) to display the desired site.

- You can select underscored items on the displayed site. When you select an item, it is highlighted.
- If there is a number at the head of the item showing the link, you can connect to that link directly by pressing the numeric key corresponding to that number. (Some sites cannot be connected.)
- While the site is displayed, press [Up] to scroll through line by line. Press [Page Up] or [Page Down] to scroll through page by page.

### When you try to obtain an SSL site (SSL page)

The display for establishing authentication appears. When obtaining is completed, the SSL page appears and "i-mode" lights.

- To cancel during authentication, select "Cancel". To cancel obtaining the SSL page after authentication, press [Quit].

## To return to a non-SSL site

The confirmation display appears asking whether to close the SSL page. Select "YES" to display an ordinary site; "NO" goes off.

### Information

- Depending on the site, you may need to apply for the service in writing separately, or to pay information fees to use it.
- The maximum display size of the images on the site is 240 x 350 dots. If an image is larger than 240 x 350 dots, it is displayed shrunk with a proportional ratio retained.
- Depending on the site, "X" might be displayed when the image is not correctly displayed.
- Depending on the site or data, you might not be able to download or save melodies, PDF files, software programs, and others.
- With some Internet web pages (sites) supporting i-mode, the color setting might make the text difficult or impossible to see.
- When you are asked from the site to send information about music you have played back on the FOMA phone, the confirmation display appears for about sending your music information. Select "YES" to send the information (title names, artist names, and played dates) of the music played back on the FOMA phone. The sent music information is used for the IP (information provider) to provide customized information to you.

## Change to Menu in English

The Menu can be displayed in English.

### 1 Menu English

Menu in English will be displayed.

- To change back to the Japanese display, select "日本語 (Japanese)".



### Information

- The Menu in English differs slightly from the Menu in Japanese.
- Items such as Tokusuru Menu and News are not shown on the Menu in English.
- Generally, "What's New" site will be updated every other Monday.



## How to View/to Operate Sites

Basic operating methods while a site is displayed are explained.



### Return to Obtained Previous Page/Go to Obtained Next Page

The FOMA phone saves the files such as the displayed Internet web pages to a temporal storage area called a cache. By pressing , you can bring up the page stored in the cache without communicating.

- When you bring up a page that exceeds the cache size on the FOMA phone or a page that is configured (created) to always read its latest information, the FOMA phone starts communication.
- When i-mode ends, the cache is cleared.

- 1 Press  to return to the previous page.  
Press  to go to the next page.

### To turn pages

You can move back up through the pages that you have displayed so far by pressing  repeatedly. However, if you display a different page ("D") from the previous page ("B"), you cannot return to "C" from "D" even when you press  twice. Instead, the pages are displayed in the order of "D" → "B" → "A".

<When pages have been displayed in the order of "A" → "B" → "C" → "B" → "D">

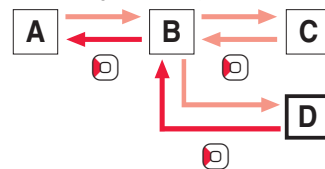







- Sequence of page display
- Sequence when previous page from the display "D" has been displayed

## Information

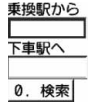
- When you display a page stored in cache, you cannot display text or settings you entered when connected before.
- When Flash movies are displayed, the site behavior might differ from the one for ordinary sites.

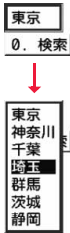
## Select/Enter Information on Sites

In sites, you may use the displayed radio buttons, check boxes, text boxes, and pull down menus.

Name	Display example	Operation/Explanation
Radio button	<input type="radio"/> : Not selected <input checked="" type="radio"/> : Selected	Radio buttons are for selecting one from multiple choices.
Check box	<input type="checkbox"/> : Not selected <input checked="" type="checkbox"/> : Selected	Check boxes are for selecting one or more items from multiple choices.
Text box		You can enter characters. Highlight a text box and press  (Select) to show the Character Entry display.
Pull down menu		You can select an item from the option list. Highlight a pull-down menu and press  (Select) to show the option list. ● You might be able to select multiple items from pull-down menus. Each time you use  to highlight an item and press  (Select), you can select/release items repeatedly. After selecting items, press  (Finish).



## Information

- Depending on the site, the display authenticating your user ID or password might appear.  
Enter your user ID and password, and then select "OK".

## Flash Function

Flash is an animation technology using pictures and sound. Flash movies make the sites more attractive. You can download Flash movies to your FOMA phone and play them back or set them for the Stand-by display.

## Information

- The maximum display size of the Flash movies on the site is 240 x 350 dots. If a Flash movie is larger than 240 x 350 dots, it is displayed shrunk with a proportional ratio retained.
- Some Flash movies refer to the phone-information data in your FOMA phone. To permit the use of the information in your FOMA phone, set "Use phone information" to "YES". ("YES" is set at purchase.)
- Effect tones sound for some Flash movies. To silence them, set "Sound effect setting" (or "Sound effect") to "OFF".
- The effect tone and vibrator for the Flash movie set for the Stand-by display do not work.
- The effect tone for Flash movies does not sound during Play Background.
- Some Flash movies may vibrate the FOMA phone while they are being played back. The FOMA phone vibrates regardless of the setting of "Vibrator".
- When you play back a Flash movie after saving to Data Box, microSD card, or Screen Memo, it might look different depending on the saving location.
- Some Flash movies might not work correctly.
- You cannot save the Flash movies if an error occurs while they are being played back.
- You can operate some Flash movies by using  or . Flash movies can be operated sometimes even when "← →" is not displayed.
- When Flash movies are displayed, the behavior might differ from ordinary sites.

## Serial Number of Mobile Phones/UIMs

When you select an item, the confirmation display might appear asking whether to send the serial number of mobile phone/UIM.

- The "serial number of your mobile phone/UIM" to be sent is used by an identifying the user, providing customized information, and for judging if the contents the IP (Information Provider) offers are available on your mobile phone.
- The "serial number of your mobile phone/UIM" is sent to the IPs (Information Providers) over the Internet, so could be deciphered by third parties. However, your phone number, address, age, and gender are not notified to the IPs (Information Providers) or others, by this operation.

## Function Menu while Site is Displayed

Function menu	Operation/Explanation
 Menu	You can return to "Menu".
<b>Bookmark</b> (Add bookmark)	See page 156.
<b>Bookmark</b> (Bookmark)	▶ <b>Bookmark</b> Go to step 1 on page 156.
<b>Screen memo</b> (Add screen memo)	See page 158.
<b>Screen memo</b> (Screen memo list)	▶ <b>Screen memo list</b> Go to step 2 on page 158.
<b>Internet</b> (Enter URL)	You can enter a URL to display an Internet web page. ▶ <b>Enter URL</b> ▶ <b>Select the text box.</b> Go to step 2 on page 155. • The URL of the displayed site is input beforehand.
<b>Internet</b> (Switch to FB)	See page 268.
<b>Reload</b>	The site contents will be updated with the latest information.

Function menu	Operation/Explanation
<b>Save image</b>	See page 160.
<b>Compose message</b>	You can compose an i-mode mail message with the URL/image of a displayed site/screen memo pasted or attached. ▶ <b>Select an item.</b> <b>Attach URL</b> . . . . . Pastes a URL to the text of an i-mode mail message. <b>Attach image</b> . . . . . Select an image to attach it to an i-mode mail message. <b>Insert dec. mail</b> . . . . . Select an image to paste it to a Deco-mail message.  Go to step 2 on page 174. • See page 178 for Deco-mail.
<b>Add to phonebook</b>	See page 82.
<b>Add desktop icon</b>	See page 109.
<b>Others</b> (Change CHR code)	When characters are not correctly displayed, you can convert them to the correct ones. ▶ <b>Change CHR code</b> • This setting is valid only for the site and Internet web page being displayed.
<b>Others</b> (Title)	You can display the title of the displayed site. ▶ <b>Title</b>
<b>Others</b> (URL)	You can display the URL of the displayed site. ▶ <b>URL</b>
<b>Others</b> (Certificate)	You can check the subject name, author, validity period and serial number of the certificate used in SSL communication. Up to five certificates are displayed. ▶ <b>Certificate</b>
<b>Others</b> (Set image display)	See page 165.
<b>Others</b> (Sound effect)	See page 165.

Function menu	Operation/Explanation
<b>Others (Retry)</b>	<p>You can play back the animation or Flash movie from the beginning.</p> <ul style="list-style-type: none"> <li>▶ <b>Retry</b> <ul style="list-style-type: none"> <li>● When a part of the Flash movie is outside the display area, the Flash movie might not be played back.</li> </ul> </li> </ul>

### Information

#### <Compose message>

- The number of characters of the URL you can paste to the text is up to 256 half-pitch characters. If the URL contains 256 half-pitch characters or more, you cannot paste it.
- You may not be able to attach or paste some images to i-mode mail.

#### <Others (Change CHR code)>

- When characters are not correctly displayed, repeat the operation. However, the previous character is displayed if you repeat the operation four times.
- Even when you repeat this operation, the correct character might not appear.
- If you change the character code when the correct characters are displayed, wrong characters might appear instead.

#### <Others (Title)>

- Up to 128 half-pitch/64 full-pitch characters can be displayed for a title.

### <Last URL>

## Displaying Most Recently Accessed Site

### Display Last URL

When you end i-mode, the URL of the page displayed last is stored as "Last URL".

You can display the page you viewed last time by selecting "Last URL" from the i-mode menu.

1  ▶ Last URL

### Information

- Some pages cannot be stored as "Last URL", such as pages whose URLs contain more than 2,048 half-pitch characters, the Obtaining Completion display for melodies or i-motion movies, etc. and FirstPass Center pages.

### Reset Last URL

You can initialize the URL of the page you viewed last time to the  Menu URL.

1  ▶ i-mode settings ▶ Reset last URL ▶ YES

### <My Menu>

## Using My Menu

If you register frequently used sites in My Menu, you will be able to access them easily.

You can register up to 45 sites.

### Register Sites in My Menu

1 Bring up a page to be registered ▶ Register My Menu

- The page configuration differs depending on the site.

2 Select the i-mode password text box

▶ Enter the i-mode password ▶ 決定 (OK)

- The entered i-mode password is displayed as "＊".
- See page 114 for the i-mode password.

### Information

- Some sites cannot be registered in My Menu.
- When you subscribe to a pay site in Menu list, it will be registered in My Menu automatically.



## Access Sites from My Menu

- 1   Menu ▶ English ▶ My Menu  
▶ Select a site to be accessed.

### Information



- If you are using Dual Network Service, you might not be able to use My Menu registered by the mova phone using the FOMA phone, or My Menu registered by the FOMA phone using the mova phone.

## <Change i-mode Password>

### Changing i-mode Password

The i-mode password (four digits) is required to subscribe to and unsubscribe from message services and i-mode pay sites, and to do i-mode mail settings.

Be sure not to let others know your i-mode password.

- 1   Menu ▶ English ▶ Options  
▶ Change i-mode Password  
▶ Select the “Current Password” text box  
▶ Enter the i-mode password (four digits).

- If you enter the i-mode password for the first time, enter “0000” (four zeros) which is set at a time of your contract.
- The entered numeral is displayed as “\*”.

- 2 Select the “New Password” text box  
▶ Enter a new i-mode password (four digits).

- Enter your own i-mode password.

- 3 Select the “New Password (Confirmation)” text box  
▶ Enter the new i-mode password (four digits) ▶ Select

- Enter the same number that you entered in step 2.

### Information

- Note that if you do not remember the i-mode password, you need to bring an identification card such as your driver's license to the handling counter of a DOCOMO shop.

## <Enter URL>

### Displaying Internet Web Pages

- 1   Go to location ▶ <NEW>

- 2 Enter a URL ▶ OK



- You can enter up to 256 half-pitch alphanumeric characters and symbols (up to 512 half-pitch characters for Full Browser).
- For Full Browser, the confirmation display appears telling that the web page might not be displayed.

### Information

- For i-mode, Internet web pages not supporting i-mode or some type of internet web pages to be connected might not be displayed correctly.
- When the file size of the page you have received exceeds the maximum obtainable size of a page, receiving is suspended. The data obtained so far might be displayable by selecting “OK”.

## Displaying Web Pages from URL History

Up to 10 entered URLs can be stored in URL History.

- 1   Go to location  
▶ Select a URL to be displayed ▶ OK

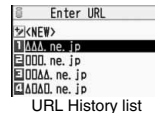

- Excluding “http://” and “https://”, up to 22 half-pitch characters can be displayed.
- You can edit the URL by selecting the URL's text box.



**Information**

- When the entered URLs exceed 10 items, the URL histories are overwritten automatically, starting from the oldest one.
- When you newly enter a URL to access a site, that URL is saved as a different record even if you access the same URL.

**Function Menu of the URL History List**

Function menu	Operation/Explanation
<b>Compose message</b>	You can compose an i-mode mail message with the highlighted URL pasted to the text. Go to step 2 on page 174. • You can compose it also by pressing   .
<b>Add desktop icon</b>	See page 109.
<b>Set as home URL</b>	You can store the site as Home URL of Full Browser. ▶ <b>YES</b> • You can operate this only from the URL History list of Full Browser.
<b>Delete</b> [Delete (Delete this)]	▶ <b>Delete (Delete this) ▶ YES</b>
<b>Delete</b> (Delete selected)	▶ <b>Delete selected ▶ Put a check mark for URL histories to be deleted ▶  (Finish) ▶ YES</b>
<b>Delete</b> (Delete all)	▶ <b>Delete all ▶ Enter your Terminal Security Code ▶ YES</b>

## &lt;Bookmark&gt;

**Bookmarking Web Pages or Sites for Quick Access****Add Bookmark**

Once you bookmark a frequently accessed site, you can display the page directly. You can register 100 bookmarks each for i-mode and Full Browser.

- 1 From the page to be registered ▶  (FUNC)
  - ▶ **Bookmark ▶ Add bookmark ▶ YES**
  - ▶ **Select a destination folder.**

**Information**



- When the number of characters used for a URL exceeds 256 half-pitch characters (512 half-pitch characters for Full Browser), you cannot store it.
- Up to 12 full-pitch/24 half-pitch characters are stored for a title. For longer titles, the excess characters are deleted. If no title is entered, the URL without "http://" or "https://" is registered.
- Some pages cannot be bookmarked.

**Display Web Pages or Sites from a Bookmark**



- 1  ▶ **Bookmark ▶ Select a folder**
  - ▶ **Select a bookmark to be displayed.**









## Function Menu of the Bookmark Folder List

Function menu	Operation/Explanation
<b>Operate folder (Add folder)</b>	You can add a new folder. You can add up to nine folders in addition to each "Bookmark" folder/"Screen memo" folder. ▶ <b>Add folder</b> ▶ <b>Enter a folder name.</b> • You can enter up to 10 full-pitch/20 half-pitch characters.
<b>Operate folder (Edit folder name)</b>	▶ <b>Edit folder name</b> ▶ <b>Edit the folder name.</b> • You can enter up to 10 full-pitch/20 half-pitch characters.
<b>Operate folder (Delete folder)</b>	You can delete the folder and all bookmarks and screen memos in the folder. You cannot delete the "Bookmark" folder/"Screen memo" folder. ▶ <b>Delete folder</b> ▶ <b>Enter your Terminal Security Code</b> ▶ <b>YES</b>
<b>Ir/  transmission (Send all Ir data)</b>	See page 320.
<b>Ir/  transmission (All  transmission)</b>	See page 322.
<b>No. of bookmarks</b>	You can check the number of bookmarks stored in all folders.
<b>Delete all</b>	The folders are not deleted. ▶ <b>Enter your Terminal Security Code</b> ▶ <b>YES</b>

## Function Menu of the Bookmark List

Function menu	Operation/Explanation
<b>Compose message</b>	You can compose an i-mode mail message with the highlighted URL pasted to the text. Go to step 2 on page 174. • You can compose it also by pressing   .
<b>Attach to mail</b>	You can send an i-mode mail message with the bookmark attached. Go to step 2 on page 174.

Function menu	Operation/Explanation
<b>Move</b>	You can move bookmarks or screen memos to another folder. ▶ <b>Select a destination folder</b> ▶ <b>Put a check mark for bookmarks or screen memos to be moved</b> ▶  <b>(Finish)</b> ▶ <b>YES</b>
<b>Edit title</b>	▶ <b>Edit the title.</b> • You can edit the title also by pressing  <b>(Edit)</b> from the list. • You can enter up to 12 full-pitch/24 half-pitch characters for a bookmark. If you press  with a blank, the URL without "http://" or "https://" is registered. • You can enter up to 11 full-pitch/22 half-pitch characters for a screen memo. If you press  with a blank, the screen memo is registered as "No title".
<b>Copy (Copy URL)</b>	You can copy the URL of the bookmark. ▶ <b>Copy URL</b> ▶ <b>Select a start point for copying</b> ▶ <b>Select an end point for copying.</b> • See page 382 for how to paste copied characters.
<b>Copy (Copy to microSD)</b>	See page 307.
<b>Set as home URL</b>	You can store the site as Home URL of Full Browser. ▶ <b>YES</b> • You can operate this only from the Bookmark list of Full Browser.
<b>Add desktop icon</b>	See page 109.
<b>Ir/  transmission (Send Ir data)</b>	See page 319.
<b>Ir/  transmission ( transmission)</b>	See page 321.
<b>No. of bookmarks</b>	You can display the number of bookmarks stored in the displayed folder.
<b>Delete [Delete (Delete this)]</b>	▶ <b>Delete (Delete this)</b> ▶ <b>YES</b>

Function menu	Operation/Explanation
Delete (Delete selected)	▶ Delete selected ▶ Put a check mark for bookmarks or screen memos to be deleted ▶ (Finish) ▶ YES
Delete (Delete all)	You can delete all bookmarks or screen memos stored in the folder. ▶ Delete all ▶ Enter your Terminal Security Code ▶ YES

<Screen Memo>

## Saving Site Contents

### Save as a Screen Memo

You can save a displayed page as a screen memo to the FOMA phone. You can display the page saved as a screen memo without connecting to i-mode.

You can save up to 100 screen memos, however, the number of screen memos you can save decreases depending on the data volume.

- From a page to be saved ▶ (FUNC) ▶ Screen memo  
▶ Add screen memo ▶ YES ▶ Select a destination folder.

- See page 163 when screen memos are stored to the maximum.

### Information

- Up to 11 full-pitch/22 half-pitch characters are stored for a title. For longer titles, the excess characters are deleted.
- If you save the Obtaining Completion display, its data file is saved as well. (The Obtaining Completion display for Chaku-uta Full® music files, for i-motion movies with playable deadline, or for the ToruCa files whose output from the FOMA phone is prohibited cannot be saved.) Some Obtaining Completion displays cannot be saved as screen memos. The display except the Obtaining Completion display is saved with a URL of that page of up to 256 half-pitch characters.
- When you save SSL pages, their SSL certificates are saved as well.
- The contents entered in the text box, or selected with the pull-down menu, check box, or radio button are not saved to screen memos.

### Information

- You can save up to 100 Kbytes per page. However, you can save up to 500 Kbytes of the i-motion Obtaining Completion display, up to 200 Kbytes of the Template Obtaining Completion display, up to 1 Kbyte of the ToruCa Obtaining Completion display, and up to 20 Kbytes of the Download Dictionary Obtaining Completion display.

### Display a Screen Memo

- ▶ Screen memo

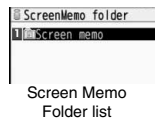

- Select a folder ▶ Select a screen memo.

- Use to check other screen memos.

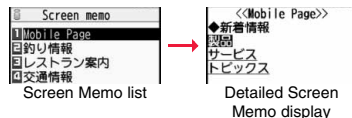

### Information

- The page saved as a screen memo has the information at the time it was saved. This might differ from the latest information on the site.

### Function Menu of the Screen Memo Folder List



Function menu	Operation/Explanation
Operate folder (Add folder)	See page 157.
Operate folder (Edit folder name)	See page 157.
Operate folder (Delete folder)	See page 157.

Function menu	Operation/Explanation
<b>Security ON/OFF</b>	You can set the folder to open only when you enter your Terminal Security Code. ▶ <b>Enter your Terminal Security Code ▶ YES</b> The folder changes to "  ". ● To release it, perform the same operation.
<b>No. of memos</b>	You can display the number of stored screen memos and protected screen memos in all folders.
<b>Delete all</b>	You can delete all screen memos. The folders will not be deleted. ▶ <b>Enter your Terminal Security Code ▶ YES</b>

### Function Menu of the Screen Memo List

Function menu	Operation/Explanation
<b>Move</b>	See page 157.
<b>Edit title</b>	See page 157.
<b>Protect ON/OFF</b>	You can protect screen memos not to be deleted. You can protect up to 50 screen memos, however, the number of screen memos you can protect decreases depending on the data volume. Protected items are indicated by "  ". ● To release protection, perform the same operation.
<b>No. of memos</b>	You can display the number of stored screen memos and protected screen memos in the displayed folder.
<b>Delete (Delete)</b>	See page 157.
<b>Delete (Delete selected)</b>	See page 158.
<b>Delete (Delete all)</b>	See page 158.

### Function Menu of the Detailed Screen Memo Display

Function menu	Operation/Explanation
<b>Compose message</b>	You can compose an i-mode mail message also by pressing  (  ). (See page 153)
<b>Edit title</b>	See page 157.
<b>Protect ON/OFF</b>	See page 159.
<b>Save image</b>	See page 160.
<b>Add to phonebook</b>	See page 82.
<b>Others (URL)</b>	You can display the URL of the screen memo. ▶ <b>URL</b>
<b>Others (Certificate)</b>	See page 153.
<b>Others (Sound effect)</b>	See page 165.
<b>Others (Retry)</b>	You can play back the animation or Flash movie from the beginning. ▶ <b>Retry</b> ● When a part of the Flash movie is outside the display area, the Flash movie might not be played back.
<b>Delete</b>	▶ <b>YES</b>

## Downloading Files or Data Items from Sites

You can download the files such as images and melodies from sites and save them to the FOMA phone. You can save some files directly to the microSD card.

### Download Image

You can save the image displayed on a site or screen memo, and then set it as the Stand-by display, Wake-up display, or another display.

You can save images, frames and marks for Deco-mail as well. You can save up to 3,500 files in total sharing the memory space with other data files, however, the number of files you can save decreases depending on the data volume. (See page 474)

#### 1 From a site display/Detailed Screen Memo display

- ▶  Save image
- ▶ Save image or Save BG image

- When you perform "Save image", select an image to be saved.

#### 2 YES ▶ Select a destination folder.

- See page 163 when images are stored to the maximum.

#### 3 To set it as a display, select "YES".

Go to "Set display" on page 283.

### Information

- Up to 36 half-pitch characters are saved for a file name. When the file name is not specified, a part of the downloaded URL or "imageXXX" (XXX denotes numerals) is saved as the file name.
- Even when an image is displayed on the site, it might not be displayed on the Picture viewer after saving it to the FOMA phone.
- The image satisfying the following conditions is saved as a Deco-mail pictogram:
  - GIF or JPEG image
  - Image of 20 x 20 dots
  - Image without file restrictions
  - Image of 6 Kbytes or less

### Information

- The image satisfying the following conditions is saved as a frame or a mark:
  - Transparent GIF (except animation GIF)
  - The extension is "ifm".
  - Image of Stand-by (240 x 427) or smaller
  - Images of Stand-by (240 x 427), CIF (352 x 288), QVGA (240 x 320), QCIF (176 x 144), and Sub-QCIF (128 x 96) are saved as frames, and others are saved as marks.
- You can save up to 100 Kbytes per image via i-mode, or 500 Kbytes per image via Full Browser.
- For Full Browser, you cannot save some images. You can save images in BMP format and PNG format only to the microSD card.

### Download Melody

You can download melodies and set them as a ring tone and other tones. You can save up to 3,500 files in total sharing the memory space with other data files, however, the number of files you can save decreases depending on the data volume. (See page 474)

#### 1 Bring up a melody downloadable site ▶ Select a melody

- ▶ Save ▶ YES ▶ Select a destination folder.

- See page 302 for operations while a melody is being played back.
- Select "Property" to display the melody information. (See page 302)
- See page 163 when melodies are stored to the maximum.
- See page 158 to save a screen memo.

#### 2 Select "YES" to set the downloaded melody as a ring tone ▶ Select an incoming type.

### Information

- For some melodies, the play part might have been specified. If you set the play-part-specified melody for a ring tone, it is played back according to the setting of "Position to play".
- Some downloaded melodies might not be played back successfully.

### Information

- Up to 36 half-pitch characters are saved for a file name. When the file name is not specified, a part of the downloaded URL or "melodyXXX" (XXX denotes numerals) is saved as the file name.
- Untitled melodies are indicated by "No title" on the Obtaining Completion display or list.
- You can save up to 100 Kbytes per melody.

### Download PDF File

You can download PDF files from sites for display. You can save up to 3,500 files in total sharing the memory space with other data files, however, the number of files you can save decreases depending on the data volume. (See page 474)

#### 1 Bring up a PDF file downloadable site ▶ Select a PDF file.

- With the PDF file that cannot be displayed unless you download all pages, the confirmation display appears asking whether to download all pages. Select "YES" to select the destination folder.
- If you have not downloaded all pages, you can additionally download the remaining pages by using "Download remain".
- See page 327 for how to save the displayed PDF file to the FOMA phone. You can save the PDF file containing pages that have not been downloaded or the PDF file of which download was suspended midway as well.
- The password entry display might be displayed depending on the PDF file. Enter the password, and then select "OK".
- See page 324 for operations while PDF file is displayed.

### Information

- The file size of the PDF file you can download from i-mode sites is up to 2 Mbytes. You cannot download the PDF file in excess of 2 Mbytes.
- You might be able to display the failed-to-download PDF file by re-downloading.

### Download Kisekae Tool File

You can download Kisekae Tool files from the site to change the ring tone, Stand-by display, icons, and others at a time. You can save up to 3,500 files in total sharing the memory space with other data files, however, the number of files you can save decreases depending on the data volume. (See page 474)

- You can download the pre-installed Kisekae Tool file from the "P-SQUARE" site. (See page 164)

#### 1 Bring up a Kisekae Tool downloadable site

- ▶ Select a Kisekae Tool file ▶ Save ▶ YES
- ▶ Phone or microSD

- When you save a Kisekae Tool file to your FOMA phone, the confirmation display appears asking whether to set the Kisekae Tool file at a time.
- Select "Property" to display the Kisekae Tool information. (See page 304)
- See page 163 when Kisekae Tool files are stored to the maximum.
- See page 158 to save a screen memo.

#### When downloading Kisekae Tool file is suspended

When you press  Quit to suspend downloading or when downloading is suspended by an incoming call, the confirmation display appears asking whether to resume downloading.

Select "YES" to resume downloading the remaining part. Select "NO" to show the Obtaining Completion display. When you select "Save pt.", select "Phone" or "microSD" to save.

You can re-download the rest of the partially saved file from "Kisekae Tool" in "Data box".

### Information

- You can save up to 2,078 Kbytes per Kisekae Tool file.

## Download ToruCa File

You can download ToruCa files from sites. You can save up to 495 files, however, the number of files you can save decreases depending on the data volume because the memory space is shared with other data files. (See page 474)

### 1 Bring up a ToruCa file downloadable site

- ▶ Select a ToruCa file ▶ Save ▶ YES
- ▶ Select a destination folder.

- Select "Display" to preview the ToruCa file. You can save the ToruCa file also by pressing  (Save) while it is previewed.
- See page 163 when ToruCa files are stored to the maximum.
- See page 158 to save a screen memo.

## Download Template

You can download templates for Deco-mail from sites. You can save up to 100 templates including the pre-installed ones, however, the number of templates you can save decreases depending on the data volume.

- You can download the pre-installed templates from the "P-SQUARE" site. (See page 164)

### 1 Bring up a template downloadable site

- ▶ Select a template ▶ Save ▶ YES

- Select "Property" to display the information about the template. (See page 182)
- See page 181 for how to check the stored template.
- See page 163 when templates are stored to the maximum.
- See page 158 to save a screen memo.

### 2 Select "YES" to compose a Deco-mail message.

See page 178 for composing Deco-mail messages.

#### Information

- When no decoration is set for the template, you cannot save it.
- When a file is attached to the template, that file is deleted.

#### Information

- When the template contains an image whose output from the FOMA phone is prohibited, the image is deleted at saving. When no decoration is found after deletion, you cannot save the template.
- The title of the downloaded template takes the name of "YYYY/MM/DD hh:mm". (Y: year, M: month, D: date, h: hour, m: minute)
- You can download up to 200 Kbytes per template file, but when the number of characters used for the mail text exceeds 5,000 full-pitch characters or 10,000 half-pitch characters, or when the total of the image size inserted exceeds 90 Kbytes, you cannot save that template file.

## Download Dictionary

You can download dictionaries from sites. You can save up to 10 dictionaries including the pre-installed ones.

- You can download the pre-installed dictionaries from the "P-SQUARE" site. (See page 164)

### 1 Bring up a dictionary downloadable site

- ▶ Select a dictionary ▶ Save ▶ YES

- Select "Property" to display the information about the dictionary. (See page 383)
- See page 158 to save a screen memo.

### 2 <Not stored> ▶ To set it as a dictionary file, select "YES".

- See page 383 for how to operate the downloaded dictionary.

#### Information

- You can save up to 20 Kbytes per dictionary.
- Depending on the site, you might not be able to download dictionaries.



## Download Chara-den Images

You can download Chara-den images from sites. You can save up to three Chara-den images including the pre-installed ones.

- You can download the pre-installed chara-den images from the "P-SQUARE" site. (See page 164)

### 1 Bring up a Chara-den image downloadable site ▶ Select a Chara-den image ▶ Save ▶ YES

- Select "Property" to display the information about the Chara-den image. (See page 299)
- See page 163 when Chara-den images are stored to the maximum.
- See page 158 to save a screen memo.

#### Information

- You can save up to 100 Kbytes per Chara-den image.

## Search by i-mode

You can look for your favorite files on the site and download them. The number of files you can save differs depending on the files you download. You cannot change the site.

### 1 Each selection display ▶ Search by i-mode ▶ YES ▶ Select a file.

- The way of downloading differs depending on the file.

#### Information

- You are separately charged a packet communication fee.

## When the data files are stored to the maximum

If the maximum number of data files is stored or there is not enough memory when you try to save the data files, the confirmation display appears asking whether to delete the unnecessary file and save new one.







• Perform this operation to save the following data:

- Images · i-motion movies · Melodies · Chara-den images
- Programs · Chaku-uta Full® music files · PDF files · i-oppli programs
- ToruCa files · Templates · Screen memos · Kisekae Tool files

1. YES ▶ Put a check mark for data files to be deleted ▶  (Finish) ▶ YES

As the data files except Chara-den images, templates, and screen memos are stored in the same storage area, you can select other files when deleting files. Select a folder and put a check mark for the files to be deleted. "\*" appears on the folder which contains the checked files.

" (Finish)" appears when you put it for the files whose amount of data is equal to memory shortage.

- You can put or clear check marks at a time by pressing  (FUNC) and selecting "Select all in page/Release in page".
- Each time you press  or  (Memory), or each time you press  (FUNC) and select "Change disp. mode", you can switch display/nondisplay of the folder volume and data volume.
- When selecting a file in "MUSIC", you can show the lower level folders by pressing  .
- Each time you press (CLR), the upper level folder returns.
- For programs, you need to delete many files when deleting other files because the data volume per program is large.
- If the maximum number of programs are stored when you execute "Move program" or try to save an i-oppli program or ToruCa file, you need to delete at least one file which belongs to the same type.
- If there is a security-applied folder for screen memos, the confirmation display appears asking whether to enable you to select screen memos in that security-applied folder. When you select "YES", you need to enter your Terminal Security Code.
- The file set for another function is indicated by "★".
- See page 224 for deleting mail-linked i-oppli.
- If you operate this when moving an i-oppli program from the microSD card to the FOMA phone, you cannot delete the i-oppli program with its data file on the IC card.

## About "P-SQUARE"

You can download the pre-installed Kisekæ Tool file, templates, dictionaries, Chara-den images, and Deco-mail pictograms from the "P-SQUARE" site (Japanese only).

☰ Menu → メニューリスト (Menu List) → ケータイ電話メーカー (Mobile Phone Maker) → P-SQUARE



QR code for  
accessing the site

## Operations from Highlighted Information

You can easily make a call, send mail, display Internet web pages, start 1Seg, book programs, and set timer recordings using highlighted information (phone numbers, mail addresses, URLs, melodies, images, and so on) displayed on sites and in mail.

- The Web To, Phone To/AV Phone To, Mail To, i- $\alpha$ pli To, Media To and Address Link functions might not be available depending on the mail sent from a personal computer or the site.
- You might be able to use the Web To, Phone To/AV Phone To, Mail To, or i- $\alpha$ pli To function using highlighted information other than a phone number, mail address or URL.
- In B Mode of 2In1, the Mail To function is not available.

## Phone To/AV Phone To Function

You can make voice calls or videophone calls by using phone numbers or similar information displayed on sites and in mail.

- The Phone To function to make a videophone call is called the AV Phone To function.

### 1 Select a phone number or similar information

▶ Select a dialing type.

- When you select "Select image", select an image to be sent to other party during a videophone call.
- Select "SMS" to compose an SMS message to send to the phone number set as the destination address. Go to step 3 on page 214.
- The choices for dialing types may not be displayed when the phone number is prefixed by "tel:" or "tel-av:". Go to step 2.

## 2 Dial

- To make an international call, select "Int'l dial assist". (See page 59)
- To set Caller ID Notification, select "Notify caller ID". (See step 2 on page 56)

## Mail To Function

You can send mail by using mail addresses or similar information displayed on sites and in mail.

### 1 Select a mail address or similar information.

The destination mail address is already entered in the address field.

Go to step 3 on page 174.

## Web To Function

You can access Internet web pages, via i-mode or Full Browser, from URL or similar information displayed on sites or in mail.

### 1 Select a URL or similar information

▶ i-mode or Full Browser ▶ YES

- When the URL or similar one contains the information of i-mode or Full Browser, you are connected via the function which corresponds to the information.
- To cancel during connection, select "Cancel". To cancel while obtaining a page, press  (Quit).

## i- $\alpha$ pli To Function

You can start i- $\alpha$ pli programs from URLs (links) displayed on sites and in mail.

### 1 Select i- $\alpha$ pli information ▶ YES

i- $\alpha$ pli starts.

### Information

- Even if i-mode mail text contains a link to start an i-appli program, you cannot quote the link when forwarding or replying to. Also, you cannot quote it when using DOCOMO keitai datalink or infrared data exchange function.

## Media To Function

You can start 1Seg, book programs, or set timer recordings from the information (links) displayed on sites and in mail.

### 1 Select 1Seg information ▶ YES

1Seg or the program booking/timer recording starts.

- When the program booking/timer recording function starts, press  (Finish) to book a program or set timer recording.

To change contents you want to book/set, go to step 1 on page 259 or step 1 on page 260.

### Information

- You may not be able to use the Media To function even if information is highlighted.

## Address Link Function

You can display a map from the postal address shown on a site or others. You can send the location information by i-mode mail as well.

### 1 Select the location information such as postal address

▶ Select an item.

Run  appli . . . .Selects and starts an i-appli program.

Read a map. . . . .Connects to the map site and displays a map.

Paste to mail. . . . .Converts the location information into a URL and composes an i-mode mail message with the URL pasted to the text.



Location info (Check loc. info)

. . . . .Displays the details of the selected location information.

<i-mode Settings>

## Setting i-mode

1  ▶ i-mode settings ▶ Do the following operations.

Item	Operation/Explanation
Scroll	You can set the number of lines that are scrolled for when you use  while displaying a site or screen memo. ▶ Select the number of lines.
Character size	See "i-mode" on page 111.
Set image display	You can set whether to display images or Flash movies included on sites or in screen memos. ▶ ON or OFF
Set connection timeout	See page 166.
Host selection	See page 166.
 motion auto-play	See page 171.
Use phone information	To display a Flash movie while a site or screen memo is displayed, the information in the FOMA phone may be used. You can select whether to permit the information to be used for that case. ▶ YES or NO
Sound effect setting	You can set whether to make an effect tone sound for when you display a Flash movie while a site or screen memo is displayed. ▶ ON or OFF
Doc. display settings	See page 327.
Check settings	You can check each of "i-mode settings".
Reset last URL	See page 154.

**Information**

## &lt;Set image display&gt;

- Even when "ON" is set, images might not be displayed correctly. In this case, "X" is displayed.
- When "OFF" is set, "OFF" is displayed and the data file is not received.
- If you change this setting, "Set image display" of "User settings" of "1Seg" is also changed.

## &lt;Use phone information&gt;

- The available information is as follows:
  - Date and time set by "Set time"
  - Reception level of radio waves
  - Battery level
  - Sound volume set by "Phone" of "Ring volume"
  - Language selected by "Select language"
  - Model name and serial number of FOMA phone

## &lt;Sound effect setting&gt;

- Even when "ON" is set, the effect tones may not sound depending on Flash movies.

## &lt;Set Connection Timeout&gt;

**Setting Connection Timeout**

It may take long to obtain some sites. You can set the time to wait before canceling obtaining. Obtaining is not canceled automatically when "Unlimited" is set.

- 1 > i-mode settings > Set connection timeout > Select a timeout value.

**Information**

- Even when you have set "Unlimited", you may be disconnected owing to radio wave conditions.

## &lt;Host Selection&gt;

MENU 8 1

**Changing a Host from i-mode (ISP Connection Communication)**

※Normally, you do not need to change this setting.

You can set the host (APN) to use for receiving services other than i-mode (DOCOMO).

If you change this setting, you will not be able to use i-mode.

- 1 > i-mode settings > Host selection > Highlight <Not recorded> and press (Edit) > Enter your Terminal Security Code.

- If you select a stored host, the setting is changed to the selected one.
- To delete the stored host, press (FUNC), select "Delete", enter your Terminal Security Code, and then select "YES".

- 2 Do the following operations.

Item	Operation/Explanation
Host name	▶ Enter a host name. • You can enter up to 9 full-pitch/18 half-pitch characters.
Host number	▶ Enter a host number. • You can enter up to 99 half-pitch alphanumeric characters.
Host address	▶ Enter a host address. • You can enter up to 30 half-pitch alphanumeric characters.
Host address 2	▶ Enter a host address 2. • You can enter up to 30 half-pitch alphanumeric characters.

- 3 Press (Finish).



## Information

- If you set any other host than i-mode, "Pake-Houdai" or "Pake-Houdai Full" are not applied.

## <SSL Certificate>

# Operating SSL Certificates

- 1  ▶ Operate certificate ▶ Certificate  
▶ Highlight a certificate and press  (FUNC)  
▶ Do the following operations.

Item	Operation/Explanation
<b>Certificate info</b>	The subject name, author, validity period, and serial number of the certificate are displayed. <ul style="list-style-type: none"><li>• You can check the certificate also by pressing  (Select) instead of  (FUNC).</li></ul>
<b>Valid/Invalid</b>	The selected item is invalidated; then " 

## Certificates used for SSL communication

- Certificate . . . . . Certificates issued by the authenticating company and stored in the FOMA phone at purchase.
- DoCoMo Certificate . . . . . Certificates required for connecting to the FirstPass Center or FirstPass sites; they are stored on the UIM (green/white).
- User Certificate . . . . . Certificates downloaded from the FirstPass Center by selecting "Client certificate" from the i-mode menu; they are stored on the UIM (green/white).

## <Client Certificate>

# Setting FirstPass

User certificates verify that you have subscribed to the FOMA service. Downloaded user certificates are stored on the UIM for the use on FirstPass sites.

When you cannot display a FirstPass site because the user certificate on the UIM has expired or the required user certificate is not stored on the UIM, you can request the issue and download the user certificate from the FirstPass Center.

- You can request and download user certificates from the FirstPass Center.
- This function is not available with the blue UIM.
- The display and operating method displayed in the FirstPass Center site are subject to change.
- To show FirstPass sites, you can use Full Browser as well.
- You cannot send/receive mail or receive Messages R/F while connected to the FirstPass Center.
- Set the date and time using "Set time" beforehand to connect to the FirstPass Center.
- This function is not available overseas.

## Client Authentication

- With the FOMA phone, server authentication and client authentication are performed for safer data exchange. The site and your FOMA phone exchange certificates, check the other party's certificate and verify each other for safer communication service. By getting client authentication, you can enjoy more secure communication services.
- Client authentication is available via the Internet communication from the FOMA phone or via the Internet communication with the FOMA phone connected to a personal computer. To use the personal computer for the client authentication, you need to install the FirstPass PC software from the provided CD-ROM. For details, refer to "FirstPassManual" (PDF format) in the "FirstPassPCsoft" folder on the CD-ROM. Adobe® Reader® (version 6.0 or higher is recommended) is required to see "FirstPassManual" (PDF format). If it is not installed in your personal computer, install Adobe® Reader® from the provided CD-ROM to see it. For details such as how to use it, refer to "Adobe Reader Help".

## Access FirstPass Center

You can perform user certificate operations on the site of the FirstPass Center site.

### 1 Operate certificate ▶ Client certificate ▶ English



Site display for the FirstPass Center

#### Information

- Before using the FirstPass Center, select "The usage regulation (Japanese only)" and carefully read the regulation.
- You are not charged a packet communication fee for connecting to the FirstPass Center.

## Request Issue of User Certificate for Download

You need to request the issue of the user certificate before you download it. When requesting the issue of your user certificate is completed, download the user certificate. After the downloading is completed, it is saved on the UIM and the FirstPass sites will be displayable.

### 1 Site display for the FirstPass Center ▶ Request your certificate ▶ Continue

- For an update, the message "Updating user certificate" is displayed.
- When you have already requested the issue of the user certificate, select "Download your certificate" from the site display for the FirstPass Center, go to step 3.



### 2 Enter your PIN2 code.

- Enter your PIN2 code within 60 seconds. When the code is not entered within 60 seconds, the connection is cut off as an error entry.
- See page 114 for PIN2 code.



### 3 Download ▶ Continue

- If you do not download the user certificate immediately, select "Menu". From the confirmation display asking whether to close the SSL page, select "YES" to return to the site display for the FirstPass Center.

#### Information

- Before downloading a new or an updated certificate, be sure to request the user certificate to be issued. User certificates cannot be downloaded until the request for issue has been made.

## Access Sites with User Certificate

You can connect to FirstPass sites with your user certificate.

### 1 Bring up a FirstPass site ▶ Select an item ▶ YES

### 2 Enter your PIN2 code.

- Enter your PIN2 code within 60 seconds. When the code is not entered within 60 seconds, the connection is cut off as an error entry.
- See page 114 for PIN2 code.

#### Information

- If you try to connect to the FirstPass site without the user certificate or when its available period is expired, the confirmation display appears asking whether to continue connecting to the site. Select "NO" to return to the previous page. Download or update the user certificate from the FirstPass Center site and then access the site again.
- The packet communication fee for accessing the FirstPass site is included in Pake-Houdai or Pake-Houdai Full.

## Request Revocation of User Certificate

You can revoke the downloaded user certificate.

### 1 Site display of the FirstPass Center ▶ Other settings

▶ Revoke your certificate ▶ YES ▶ Enter your PIN2 code.

- Enter your PIN2 code within 60 seconds. When the code is not entered within 60 seconds, the connection is cut off as an error entry.
- See page 114 for PIN2 code.

### 2 Continue ▶ Continue ▶ Continue



#### Information

- To use FirstPass after revoking a certificate, you need to apply again for your user certificate to be issued and then download it.
- See page 167 for how to view the download user certificate.

<Certificate Host>

## Changing a CA Center

※Normally, you do not need to change this setting.

You can set the host for downloading the user certificate.

### 1 ▶ Operate certificate ▶ Certificate host ▶ Highlight <Not recorded> and press (Edit).

- If you select a stored host, the setting is changed to that host.
- To delete the stored host, press (FUNC), select "Delete", enter your Terminal Security Code, and then select "YES".

## 2 Enter your Terminal Security Code

▶ Do the following operations.

Item	Operation/Explanation
Default URL	▶ Enter a default URL. • You can enter up to 100 half-pitch alphanumeric characters.
Host address	▶ Enter a host address. • You can enter up to 99 half-pitch alphanumeric characters.

### 3 Press (Finish).

#### ■ Before Using FirstPass

- FirstPass is DOCOMO's electronic authentication service. By using FirstPass, client authentication is enabled, whereby the site and your FOMA phone exchange certificates, check the other party's certificate and perform mutual authentication.
- When requesting issue of a user certificate, carefully read "The usage regulation (Japanese only)" on the display, agree to this, and then make the request.
- You need to enter the PIN2 code to use the user certificate. Once you have entered your PIN2 code, all subsequent operations will be deemed to be done by you, so be careful not to let anyone else use your UIM or PIN2 code.
- If your UIM is lost or stolen, "DOCOMO Information Center" on the back page of this manual can revoke your user certificate.
- DOCOMO bears no obligation or responsibility with regard to the sites and information provided by FirstPass sites. Please solve the problem between you and FirstPass sites.
- DOCOMO and the CA do not guarantee security when you use FirstPass and SSL, so you should use them on your own judgment and responsibility.

## What is i-motion?

i-motion movies are composed of video, sound and music, and you can play them back obtaining from i-motion compatible sites into your FOMA phone. You can set the i-motion movie for a ring tone.

Two types of i-motion movies are available as shown below. The type of the obtained i-motion movie differs depending on the site or file.

You can save up to 10 Mbytes per i-motion movie.

Categories		Description
Type	Playback type	
<b>Standard (normal) type (can be saved)</b>	Plays back after obtaining	Plays back after obtaining all the data of an i-motion movie.
	Plays back while obtaining	Plays back while obtaining an i-motion movie. After obtaining, you can play it back in the same way as "Plays back after obtaining".
<b>Streaming type (cannot be saved)</b>	Plays back while obtaining	Plays back while obtaining an i-motion movie. The data is deleted after playback, so you cannot play it back again or save it to the FOMA phone.

<Obtain i-motion Movie>

## Obtaining i-motion Movies from Sites

### Play Back an i-motion Movie Obtained from a Site

#### 1 Select an i-motion movie from an i-motion obtainable site ▶ Play

See page 290 for the operation during playback.

- If an i-motion movie can be played back during obtaining, it will be played back during obtaining.
- If "i motion auto-play" is set to "ON", the i-motion movie will be played back automatically after it is obtained.
- Select "Property" to display the i-motion information. (See page 291)
- See page 158 to save a screen memo.

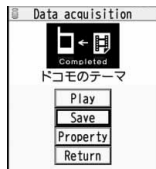

Obtaining Completion display

### Information

- Depending on the accessed site or an i-motion movie, you might not be able to obtain the data or play it back during obtaining, or play it back after obtaining. Also, you cannot obtain an i-motion movie in ASF format.
- See page 291 for the file formats of playable i-motion movies.
- The playback stops when you close the FOMA phone while playing back an i-motion movie.
- Even when you stop playing back the data of standard (normal) type while obtaining, obtaining still continues.
- Even if "i motion auto-play" is set to "ON", the data is not automatically played back after obtaining when it is played back while obtaining.
- For an i-motion movie that has restrictions on the number of playbacks, playable period, or playable deadline, "i" is displayed at the head of the title. An i-motion movie with the playable period restricted cannot be played back before or after the restriction period. If you remove the battery and keep it aside for a long time, the date/time information in your FOMA phone might be reset. In that case, you cannot play back the i-motion movie that has restrictions on the playable period and playable deadline. See "i motion info" for checking the playback restrictions.
- "i motion info" of an i-motion movie and deadline information on the display that notifies you of a playable deadline are shown by date/time with "Summer time" set to "OFF".
- Depending on the line speed, line state, or radio wave conditions, the playback during obtaining might be suspended or the images might be distorted. You can repeatedly play back the standard (normal) type of i-motion movies after obtaining, but cannot play back the streaming type of i-motion movies.

### Save an i-motion Movie

You can save the obtained i-motion movie to your FOMA phone and set it for a ring tone, the Stand-by display, and the Wake-up display. You can save up to 111.6 Mbytes of files in total sharing the memory space with other data files. (See page 473)

#### 1 Obtaining Completion display ▶ Save ▶ YES ▶ Select a destination folder.

- See page 163 for when i-motion movies are stored to the maximum.

#### 2 Select "YES" to execute "Set i motion".

Go to "Set i motion" on page 291.



## When downloading i-motion movie is suspended

When you press  (Quit) to suspend downloading or when downloading is suspended by an incoming call, the confirmation display appears asking whether to resume downloading.

Select "YES" to resume downloading the remaining part. Select "NO" to show the Obtaining Completion display for a partially savable i-motion file. Select "Save pt." to save that file to any folder in "i motion" in "Data box".

You can re-download the rest of the partially saved file from "Data box".

- The file name of the partially saved i-motion movie is "movie".
- When the playable period or playable deadline of the partially saved i-motion movie has expired, you cannot download the remaining segments of the file. You can delete the partially saved file when you try to download the file.

### Information

- Depending on the i-motion movie, you might not be able to save the obtained data to the FOMA phone.
- Partially saved i-motion movies cannot be played back from Data Box.

<  motion Auto-play >

## Setting Automatic Replay of i-motion Movies

You can set whether to play back an i-motion movie automatically, for when you have obtained a standard (normal) type of i-motion movie from a site or have selected a screen memo which contains a standard (normal) type of i-motion movie.

 i-mode settings  motion auto-play  ON or OFF

### Information

- Note that a streaming type of i-motion movie is played back automatically even if this function is set to "OFF".

## What is i-Channel?

This service distributes graphical information such as news and weather forecast to i-Channel mobile phones. You periodically receive information and the latest one flows on the Stand-by display by tickers. You can read it on the i-Channel list by pressing the i-Channel key. (See page 172)



Further, two types of channels, "Basic channel" provided by DOCOMO and "Favorite channel" provided by IPs (Information Providers) are available. You are not charged a packet communication fee for auto-updates of "Basic channel" information.

You are charged a packet communication fee for auto-updates of "Favorite channel" information which is enabled by registering your favorite channels. Note that you are separately charged a packet communication fee for browsing detailed information.

When you use the international roaming service, you are charged a packet communication fee for both auto-update and browsing detailed information.

- i-Channel is a pay service which is available on a subscription basis. (You need to subscribe to i-mode to apply for i-Channel.)
- For details on i-Channel, refer to the "Mobile Phone User's Guide [i-mode] FOMA version".
- The i-Channel service is provided in Japanese only.

### Information

- When the FOMA phone is turned off or if radio wave conditions are bad such as when it is out of the service area, you may not be able to receive information even if you have contracted to the i-Channel service. In that case, select the channel for unsigned subscribers that appears by pressing ; then you can now receive information, and tickers flow on the Stand-by display. If your FOMA phone remains in the default state, you may not be able to receive information. Press , and then information is received and tickers flow on the Stand-by display.
- To receive i-Channel information overseas, you are charged a communication fee by channel (domestic talk-free service does not apply).
- After you cancel the contract for the i-Channel service, the ticker setting is automatically set to off.
- If you cancel the contract for the i-mode service before you cancel the contract for the i-Channel service, the ticker setting remains on.

## Using i-Channel

When "Ticker ON/OFF" is set to "ON", up to 10 ticker files for the latest information flow repeatedly on the Stand-by display. If you want to know more about the information, you can obtain the details from the Channel list.

### 1 Press .

The Channel list appears regardless of the "Ticker ON/OFF" setting.

-  blinks during receiving information.

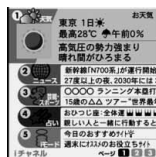

Channel list

### 2 Select an item (link).

#### Information

- The ring tone does not sound and the vibrator does not work even when information comes in. In addition, the Call/Charging indicator does not light or flicker.

- Tickers are not displayed in the following cases:

When the information is automatically updated after that or when you press  to receive the latest information, tickers automatically flow.

- When the UI is replaced.
- When "Host selection" is changed
- When "Reset i-Channel" is executed.
- When "Reset settings" is executed.
- When "Initialize" is executed.

However, the information might not be automatically updated when "Host selection" is changed. To receive the latest information, press  to display the Channel list.

- When "Host selection" is changed, the i-Channel connecting end is also changed. (In ordinary, you do not need to change the setting.)
- Depending on your usage state, you might receive information from i-Channel when you display the Channel list.
- Even if you change "i-mode" of "Character size", the character size for the Channel list might not be changed instantly.

## Setting How Ticker is Displayed

### 1 i-Channel ▶ Do the following operations.

Item	Operation/Explanation
Channel list	You can display the Channel list. Go to step 2 on page 172.
Ticker ON/OFF	You can set whether to display tickers on the Stand-by display. ▶ <b>ON or OFF</b>
Ticker font size set.	See "i-Channel ticker" on page 111.
Ticker color set.	You can set the background color and font color of ticker. ▶ <b>Select a pattern.</b>
Ticker scroll speed	You can set the ticker flowing speed. ▶ <b>Select a speed.</b>
Reset i-Channel	You can initialize the ticker information and set "Ticker ON/OFF" to "ON". ▶ <b>Enter your Terminal Security Code ▶ YES</b>

#### Information

- You can perform "Ticker ON/OFF", "Ticker font size set.", "Ticker color set.", "Ticker scroll speed", and "Reset i-Channel" for each mode of 2in1. However, i-Channel information is initialized for all modes. Further, when 2in1 is deactivated, they become common to the settings in A Mode.

#### <Ticker ON/OFF>

- In Public Mode (Drive Mode), or during Lock All, tickers are not displayed.

#### <Ticker color set> <Ticker scroll speed>

- You can check the ticker by pressing  (Play). Press  to return to the former display.

#### <Reset i-Channel>

- Tickers are not displayed after you execute "Reset i-Channel". When the information is automatically updated after that or when you press  to receive the latest information, tickers automatically flow.

What is i-mode Mail? .....	174	<b>Setting Mail Settings</b>	
<b>Composing i-mode Mail/Deco-mail</b>		Sorting Mail Automatically to Each Folder .....	<Auto-sort> 201
Composing i-mode Mail to Send .....	<Compose Message> 174	Creating Mail Group .....	<Mail Group> 203
Composing Deco-mail to Send .....	178	Setting Mail and Messages R/F .....	<Mail Settings> 204
Composing Deco-mail by Using Template .....	<Template> 181	<b>Using Message Services</b>	
Attaching Files .....	<Attachments> 182	Receiving Messages R/F Automatically .....	<Receive Message R/F> 206
Using Photo-sending .....	<Photo-sending> 184	Reading Received Messages R/F .....	<Display Message R/F> 207
<b>Receiving and Operating i-mode Mail</b>		<b>Using Early Warning “Area Mail”</b>	
Receiving i-mode Mail Automatically .....	<Mail Auto-receive> 185	What is Early Warning “Area Mail”? .....	208
Receiving Selected i-mode Mail .....	<Receive Option> 186	Receiving Early Warning “Area Mail” .....	208
Checking whether Center Holds i-mode Mail .....	<Check New Message> 187	Setting Early Warning “Area Mail” .....	<Area Mail Settings> 209
Replying to Received i-mode Mail .....	<Reply> <Reply with Quote> 187	<b>Using Chat Mail</b>	
Forwarding Received i-mode Mail .....	<Forward> 188	Using Chat Mail .....	<Chat Mail> 210
When i-mode Mail with Files Attached/Pasted is Received ...	188	Creating Chat Group .....	<Chat Group> 213
<b>Operating Mail Box</b>		<b>Using SMS</b>	
Displaying Mail from Inbox/Outbox/Draft .....	<Inbox> <Outbox> <Draft> 190	Composing SMS Messages to Send .....	<Compose SMS> 214
How to See Inbox/Outbox/Draft List and Detailed Display .....	191	Receiving SMS Messages Automatically .....	<Receive SMS> 215
Managing Mail Messages .....	195	Checking whether Center Holds SMS Messages .....	<Check New SMS> 216
<b>Using Mail History</b>		Setting SMS .....	<SMS Settings> 216
Displaying Sent/Received Mail Record .....	<Sent Address> <Received Address> 200	<b>Using Web Mail</b>	
		Using Web Mail .....	<Web Mail> 217

## What is i-mode Mail?

Once you subscribe to i-mode, you can exchange e-mails over the Internet as well as among i-mode phones.

You can attach up to 10 files (photos, movie files, etc.) within 2 Mbytes in total besides mail text. The i-mode mail also supports Deco-mail, so you can change the character color, character size, and background color of mail text. Further, you can use the Deco-mail pictograms, so you can easily send expressive messages.

• For details on i-mode mail, refer to the "Mobile Phone User's Guide [i-mode] FOMA version".

### <Compose Message>

## Composing i-mode Mail to Send

You can compose and send i-mode mail messages.

You can save up to 1,000 sent i-mode mail messages including SMS messages to the Outbox.

See page 178 for composing a Deco-mail message.

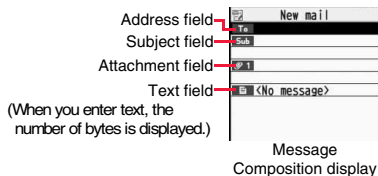

## 2 Select the address field ▶ Select an item.

**Phonebook** . . . . . Call up a Phonebook entry and select a phone number or mail address.

**Sent address** . . . . . Select a phone number or mail address and press



**Received address** . . . . . Select a phone number or mail address and press



**Mail group** . . . . . Select a mail group.

**Enter address** . . . . . Enter a mail address or phone number.

- You can enter up to 50 half-pitch characters.
- If the destination is an i-mode phone, you can send mail also by entering only the part preceding the "@" mark of a mail address.
- See page 175 for sending to multiple destination addresses.
- See page 176 for deleting an added address.

## 3 Select the subject field ▶ Enter a subject.

- You can enter up to 100 full-pitch/200 half-pitch characters.

## 4 Select the attachment field ▶ Select an item.

- See page 182 for how to select an attachment.

## 5 Select the text field ▶ Enter text.

- You can enter up to 5,000 full-pitch/10,000 half-pitch characters.
- See page 176 for pasting a header or signature.
- You can select a Deco-mail picture by pressing and holding  for at least one second.

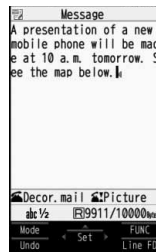

Message Entry display

## 6 Press (Send).

The animation display during transmission appears and the mail message is sent.

- To cancel sending midway, press  (Cancel) or press and hold **CLR** (for at least one second). However, the mail message might be sent depending on the timing.







## Information

- Depending on the radio wave conditions, the characters might not be displayed correctly at the destination.
- If you send an i-mode mail message with a pictograph entered to another carrier's mobile phone, the pictograph is automatically converted into a similar pictograph at the receiving end. Depending on the model or function of the receiving end's mobile phone, however, the pictograph might not be correctly displayed or be converted into a character or "=" when no corresponding pictograph is found.
- When the number of sent mail messages exceeds the FOMA phone's storage maximum, they will be overwritten from the oldest one. However, protected sent mail messages cannot be overwritten.
- You cannot compose an i-mode mail message when sent mail messages in the Outbox are saved to the maximum and all of them are protected, when 20 draft mail messages are saved, or when the Draft is full.  
Release the protection for sent mail messages, or send/delete draft mail messages, and then operate again.
- When you select "Compose message" from the Function menu such as when entering a phone number, the mail address is entered as a destination address if the phone number and mail address are stored in a Phonebook entry. When multiple mail addresses are stored in the Phonebook entry, the first mail address is entered.
- If you try to send the mail whose address is a phone number headed by "184"/"186", the confirmation display appears asking whether to delete prefix numbers and send the mail.
- When a destination phone number or mail address is stored in a Phonebook entry, the name stored in the Phonebook entry is displayed in the address field.
- You cannot send mail to the addresses that include a comma (,).
- You can enter an address in the To, Cc and Bcc fields.
- If a Phonebook entry with a secret code is set as a destination address, the secret code will be automatically added at sending. Even if a secret code is set for the Phonebook entry, however, it will not be added and the i-mode mail message will be sent as ordinary one unless the destination address is a phone number or "phone number@docomo.ne.jp".
- If you store the secret code and send mail to a mail address other than that of DOCOMO mobile phones, you might not receive the error message for unknown address.
- The recipients might not be able to receive the full length of the subject depending on their phones.
- You can send up to 2,000 full-pitch characters in text to the i-mode phone of the mova service.

## Information

- Each line feed is counted as one full-pitch character, and a space is counted as one full-pitch or half-pitch character.
- The mail message you entered a Deco-mail pictogram becomes a Deco-mail message.
- In B Mode of 2in1, you cannot compose i-mode mail.

## Function Menu of the Message Composition Display

Function menu	Operation/Explanation
<b>Send</b>	You can send the mail message. Go to step 7 on page 175.
<b>Preview</b>	Check the address, subject, text and attachments before sending. <ul style="list-style-type: none"> <li>You can send the mail message by pressing  .</li> </ul>
<b>Save</b>	When composing or editing the mail, you can save it to the Draft.
<b>Operate receiver (Add receiver)</b>	You can add multiple addresses in the address field to send the same i-mode mail to multiple recipients simultaneously. You can send the same mail to up to five addresses at the same time. <b>▶ Add receiver ▶ Select an item.</b> <b>Phonebook</b> . . . . . Call up a Phonebook entry and select a phone number or mail address. <b>Sent address</b> . . . . . Select a phone number or mail address and press  (Select). <b>Received address</b> . . . . . Select a phone number or mail address and press  (Select). <b>Enter address</b> . . . . . Enter a mail address or phone number. <ul style="list-style-type: none"> <li>To consecutively add addresses, select &lt;Not entered&gt; and repeat the above operations.</li> <li>Press  (FUNC) and select "Delete receiver" to delete the selected mail address. Select "YES".</li> <li>Press  (FUNC) and select "Change rcv. type" to change the type of mail. (See page 176)</li> <li>Select an entered mail address on the Mail Composition display to show the Address list.</li> </ul> <b>▶  (Finish)</b>

Function menu	Operation/Explanation
<b>Operate receiver (Delete receiver)</b>	You can delete the selected address when there are multiple addresses. ▶ <b>Delete receiver</b> ▶ <b>YES</b>
<b>Operate receiver (Change rcv. type)</b>	▶ <b>Change rcv. type</b> ▶ <b>Select a type of address.</b> <b>To</b> . . . . This is the direct destination address. "To" recipients are displayed at the receiving ends.※ <b>Cc</b> . . . . Specify to let parties know the mail contents in addition to the direct recipients. "Cc" recipients are displayed at the receiving ends.※ <b>Bcc</b> . . . . Specify to hide the recipients from others. "Bcc" recipients are not displayed at the receiving ends. ※They might not be displayed depending on the mobile phone, device, or mail software of the receiving end.
<b>Operate att. file (Activate camera)</b>	You can shoot and attach an image or i-motion movie. ▶ <b>Activate camera</b> ▶ <b>Select a shooting mode.</b> ● See page 135 and page 137 for how to shoot.
<b>Operate att. file (Attach file)</b>	See page 182.
<b>Operate att. file (Delete att. file)</b>	See page 184.
<b>Template (Load template)</b>	You can read in a template and compose a Deco-mail message. ▶ <b>Load template</b> ● When the text has already been entered, the confirmation display appears asking whether to delete the text. ▶ <b>Select a template.</b> The contents of the template are entered into the text. ● While selecting a template, press  to check the contents of the template. ● See page 178 for composing a Deco-mail message.
<b>Template (Save template)</b>	You can save the Deco-mail message you are composing as a template. ▶ <b>Save template</b> ▶ <b>YES</b> ● See page 163 when templates are stored to the maximum. ● See page 181 for how to check the stored template.

Function menu	Operation/Explanation
<b>Add header/sig.</b>	You can paste a header/signature at the beginning or ending of the text of the i-mode mail message. ▶ <b>Add header or Add signature</b> ● You need to store the header/signature beforehand. (See page 205)

### Information

#### <Operate receiver>

- You cannot add any addresses if the address field for "To", "Cc", and "Bcc" already contains five addresses in total or contains no addresses.
- You cannot send i-mode mail if the "To" field is blank.

#### <Template (Save template)>

- The subject of i-mode mail you are composing will be the title of the template. If no subject is entered, the title takes the name of "YYYY/MM/DD hh:mm". (Y: year, M: month, D: date, h: hour, m: minute)

#### <Add header/sig.>

- You cannot paste a header/signature if the text, including the header/signature, would exceed 5,000 full-pitch or 10,000 half-pitch characters.
- If the decoration such as font color or character size is set for the top or end of text, the header or signature will be decorated as well.

## Function Menu of the Message Entry Display

Function menu	Operation/Explanation
<b>Decorate mail</b>	See page 179.
<b>Template (Load template)</b>	See page 176.
<b>Template (Save template)</b>	See page 176.
<b>Full pitch/Half pitch</b>	See page 378.
<b>Copy</b>	See page 381.
<b>Cut</b>	See page 381.
<b>Paste</b>	See page 382.

Function menu	Operation/Explanation
<b>Undo</b>	After entering or deleting characters, pasting data, or operating on a decoration, you can undo your most recent operation. You can do it up to twice. <ul style="list-style-type: none"> <li>You can undo the operation also by pressing  (<b>Undo</b>).</li> </ul>
<b>Pictograph/symbols (Pictograph)</b>	See page 379.
<b>Pictograph/symbols (Symbols)</b>	See page 379.
<b>Pictograph/symbols (Space)</b>	See page 379.
<b>Phrase/code/quote (Common phrases)</b>	See page 379.
<b>Phrase/code/quote (Kuten code)</b>	See page 379.
<b>Phrase/code/quote (Input time)</b>	See page 379.
<b>Phrase/code/quote (Quote phonebook)</b>	See page 379.
<b>Phrase/code/quote (Quote own data)</b>	See page 379.
<b>Phrase/code/quote (Bar code reader)</b>	See page 143.
<b>Char. input/dict. (Own dictionary)</b>	See page 382.
<b>Char. input/dict. (Learned words)</b>	See page 382.
<b>Char. input/dict. (Change input mode)</b>	See page 380.
<b>Char. input/dict. (Candid. disp. size)</b>	See "Character input (Candid. disp. size)" on page 111.

Function menu	Operation/Explanation
<b>Char. input/dict. (Predict)</b>	See page 378.
<b>Char. input/dict. (Candidate display)</b>	See page 380.
<b>Char. input/dict. (Character set time)</b>	See page 380.
<b>Char. input/dict. (2/NIKO-touch guide)</b>	See page 380.
<b>Help</b>	See page 380.
<b>JUMP</b>	See page 380.
<b>Preview</b>	You can check the contents of the text before sending.

### Information

#### <Undo>

- Once you use "Undo" to return to the previous status, you cannot cancel this by using "Undo" again.
- If you close the Message Entry display, you cannot return to the previous status by using "Undo" when you re-open it. (However, after you have exited "Preview", you can return to the previous status by "Undo".)

## Composing Deco-mail to Send

When editing an i-mode mail message, you can change the size of the font and the color of the background as well as inserting images, thus composing your own original mail.

You can compose Deco-mail also using the templates (patterns). (See page 181)



Activated decoration

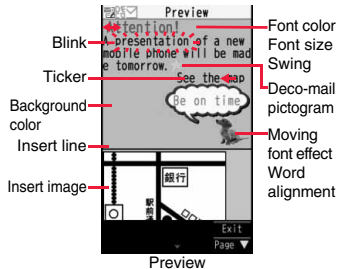

**1** Perform the operations in step 1 through step 4 on page 174.

**2** Select the text field ▶ Decorate the text using Palette.

- See page 179 for how to use Palette.

### To enter text after selecting decorations

 ▶ Select one of decorations ▶ Enter text.

### To set decorations after entering text

Enter text ▶  ▶  (Select area)

Go to "Select area" on page 180.

- You can enter up to 5,000 full-pitch/10,000 half-pitch characters. (The number of characters you can enter decreases depending on the decoration.)
- Once you decorate the mail text, "DECO" appears.

**3** Press  (Set).

The Message Composition display is displayed.

Go to step 6 on page 174.

### Information

- Even if you delete the decorated characters, only the decoration data remain and the number of characters you can enter might decrease. Clear the decoration and then delete the characters. If you delete the characters by pressing and holding  for at least one second, the characters as well as the decoration data are deleted.
- When you reply with quote to a received Deco-mail message or you forward it, the decorations and inserted images are entered in text as they are.
- If you use a template containing an image unable to attach to mail for sending, the image is deleted.
- When you send a Deco-mail message in excess of 10,000 bytes, the mail message with the URL for browsing is received at some destination i-mode phones. However, only the mail text without the URL for browsing might be received at some models.
- Decorations might not be correctly displayed if you send/receive Deco-mail messages to/from the devices such as personal computers.
- The movement of Ticker/Swing, blink and animation playback stop when a certain period has passed.



## About Decorations

### You can decorate the text of i-mode mail using Palette. You can set multiple decorations for one point.

- You cannot combine Word Alignment, Ticker, and Swing for one point.
- Lines are inserted by Line Insert with the color specified by Font Color.
- If Word Alignment, Ticker, or Swing is specified, the images and moving font effects are inserted with the specified state.
- You can enter Deco-mail pictograms using "Insert image", and by "Pictograph" on the Function menu as well.

#### How to use Palette

Press from the Message Entry display to display Palette.

- When the cursor is over the decorated character, the Palette appears with the icon for the set decoration depressed.
- Highlight the depressed icon and press (Select); then you can change, complete or cancel the decoration. You can release the area selection also by pressing while the area is selected.
- Press (Exit) to close Palette. You can close Palette also by pressing while you are operating on it.

#### Switch operations

You can switch between the operation of Palette and the operation of entering text, each time you press . You can move the cursor and enter text with Palette displayed.







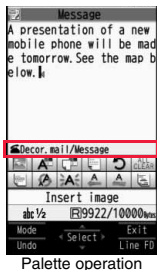

- After you enter text, the text entry operation returns.
- When you use Palette in succession, press and operate it.

















#### How to operate Decoration

Function	Operation/Explanation
<b>Insert image</b> (Font effect)	You can convert characters to a mark and insert it into the text. The mark animates in various ways and conveys your feelings to the other party. ▶  ▶ <b>Select a moving font effect</b> ▶ <b>Enter text.</b> <ul style="list-style-type: none"><li>• To delete the moving font effect, move the cursor to the moving font effect and press .</li></ul>



Function	Operation/Explanation
<b>Insert image</b> (My picture)	You can insert the image stored in "My picture" into the text of mail. ▶  ▶ <b>Select a folder</b> ▶ <b>Select an image.</b> <ul style="list-style-type: none"><li>• You can select a Deco-mail picture by pressing and holding  for at least one second from the Message Entry display.</li><li>• To delete the image, move the cursor to the image and press .</li></ul>
<b>Insert image</b> (Camera)	You can insert the image shot by the camera on the spot into the text of mail. ▶  ▶ <b>Shoot a still image.</b> <ul style="list-style-type: none"><li>• The image size of the camera is Sub-QCIF (128 x 96), QCIF (176 x 144), QVGA (240 x 320), CIF (352 x 288) or Stand-by display (240 x 427).</li><li>• To delete the image, move the cursor to the image and press .</li><li>• See step 2 and step 3 on page 135 for how to shoot.</li></ul>
<b>Font color</b>	You can change the color of characters and lines to be entered. ▶ <b>Select a color</b> ▶ <b>Enter text.</b> <ul style="list-style-type: none"><li>• In the font color changing mode, "A" is displayed at the upper right of the display.</li><li>• You can set other decorations in succession.</li><li>• When you have selected the area, you do not need to enter text.</li></ul>
<b>Background color</b>	You can change the background color of the mail text. ▶ <b>Select a color.</b>
<b>Insert line</b>	You can insert a horizontal line into the mail text. The line feed is inserted automatically, and the line is inserted. <ul style="list-style-type: none"><li>• To delete the line, move the cursor to the line and press .</li></ul>
<b>Undo</b>	You can return to the previous status of the set decoration. You can do it up to twice. <ul style="list-style-type: none"><li>• You can undo the operation also by pressing  .</li></ul>

Function	Operation/Explanation
 <b>Decorate all reset</b>	<p>You can release all the decorations.</p> <p>▶ <b>YES</b></p> <ul style="list-style-type: none"> <li>• If you have inserted an image, the message "In-line image is deleted" is displayed.</li> </ul>
 <b>Select area</b>	<p>You can set Font Color, Blink, Font Size, Word Alignment, Ticker and Swing over the selected text you have entered. You can also change the set decoration, add another decoration, or cancel Blink, Ticker or Swing.</p> <p>▶ <b>Select a start point.</b></p> <ul style="list-style-type: none"> <li>• You can select all text by pressing  (All) and selecting "YES".</li> </ul> <p>▶ <b>Select an end point.</b></p> <p>Set, change, add or cancel each decoration.</p> <ul style="list-style-type: none"> <li>• "/SELECT" is displayed at the upper right of the display during selecting decoration area.</li> </ul> <p>&lt;Set, change, or add decoration&gt;</p> <p>▶ <b>Select an icon and set, change, or add decorations.</b></p> <ul style="list-style-type: none"> <li>• Select another icon in succession to change the multiple decorations or add decorations.</li> </ul> <p>▶ </p> <ul style="list-style-type: none"> <li>• When Blink, Ticker, or Swing has been set, reselect each icon and complete decorations.</li> </ul> <p>&lt;Release Blink, Ticker, or Swing&gt;</p> <p>▶ <b>Select the icon for Blink, Ticker, or Swing</b></p> <p>▶ <b>Select the same icon again.</b></p>
 <b>Font size</b>	<p>You can change the size of characters to be entered.</p> <p>▶ <b>Select a font size ▶ Enter text.</b></p> <ul style="list-style-type: none"> <li>• In the font size changing mode, "" or "" is displayed at the upper right of the display.</li> <li>• You can set other decorations in succession.</li> <li>• When you have selected the area, you do not need to enter text.</li> </ul>

Function	Operation/Explanation
 <b>Select blink</b>	<p>You can make characters to be entered blink.</p> <p>▶ <b>Enter text.</b></p> <p>The set characters are blinking.</p> <ul style="list-style-type: none"> <li>• In the blink setting mode, "" is displayed at the upper right of the display.</li> <li>• You can set other decorations in succession.</li> </ul> <p>▶   <b>(Reset blink)</b></p>
 <b>Select ticker</b>	<p>You can make characters to be entered and images to be inserted flow (moving from right to left).</p> <p>▶ <b>Enter text.</b></p> <p>The line feed is inserted automatically and "" is displayed before and after the cursor.</p> <ul style="list-style-type: none"> <li>• In the ticker setting mode, "" is displayed at the upper right of the display.</li> <li>• You can set other decorations in succession.</li> </ul> <p>▶   <b>(Reset ticker)</b></p> <p>The line feed is inserted automatically.</p>
 <b>Select swing</b>	<p>You can make characters to be entered and images to be inserted swing (moving to left and right back).</p> <p>▶ <b>Enter text.</b></p> <p>The line feed is inserted automatically and "" is displayed before and after the cursor.</p> <ul style="list-style-type: none"> <li>• In the swing setting mode, "" is displayed at the upper right of the display.</li> <li>• You can set other decorations in succession.</li> </ul> <p>▶   <b>(Reset swing)</b></p> <p>The line feed is inserted automatically.</p>
 <b>Word alignment</b>	<p>You can change the position of characters to be entered and images to be inserted.</p> <p>▶ <b>Select a word alignment ▶ Enter text.</b></p> <p>The line feed is inserted automatically, and the alignment is set.</p> <ul style="list-style-type: none"> <li>• In the word alignment setting mode, "" is displayed at the upper right of the display.</li> <li>• You can set other decorations in succession.</li> <li>• When you have selected the area, you do not need to enter text.</li> </ul>

## Information

### <Insert image>

- You can insert up to 20 types of images within 90 Kbytes in total. However, even if the inserted types of images are 20 or fewer, the confirmation display appears for some operations asking whether to re-edit the text because the maximum number of images has exceeded.
- If multiple same images are inserted, they are counted as a single type of file. If you copy/paste the image already inserted, that image is regarded as the same image and handled as a single type of file.

### <Font color>

- If you move the cursor to the character for which another color is set, the setting changes to that color.
- The color for pictographs is also subjected to the specified font color. To restore the color to ordinary one, select “指定なし/Default”.
- You cannot change the color of Deco-mail pictographs.

### <Background color>

- You cannot change the background color when editing the header or signature.

### <Font size>

- If you move the cursor to the character for which a different font size is set, the font size is changed to that size of the character.
- You cannot change the size of the Deco-mail pictogram.

### <Select blink>

- You cannot make Deco-mail pictographs blink.

## <Template>

# Composing Deco-mail by Using Template

Template is form data for Deco-mail for which decorations such as font size and image insertion are already specified.

Other than those pre-installed in the FOMA phone, you can download templates from sites (see page 162). You can also save Deco-mail you sent, received or composed as a template (see page 176 and page 199). You can edit the saved template using Palette.

- You can delete the pre-installed templates. You can re-download them from the “P-SQUARE” site (see page 164). When you use a UIM other than the one used for downloading, the UIM security function (see page 37) is set for them.

## 1 [Template] ▶ Select a template.

- Press [Template] to compose a Deco-mail message using the contents of the template. Go to step 2 on page 174.
- Even if you set “Header/signature” to automatically paste the header or signature, you cannot paste it.
- See page 163 when you select “Search by i-mode”.



Template list



Detailed Template display

## Function Menu of the Template List

Function menu	Operation/Explanation
Compose message	You can compose a Deco-mail message using the contents of the template. Go to step 2 on page 174.

Function menu	Operation/Explanation
Sort	You can change the order of displayed templates. ▶ <b>Select an order.</b>
Edit title	▶ <b>Enter a title.</b> ● You can enter up to 15 full-pitch/30 half-pitch characters.
Info	You can display the file size, saved date and time of the template, and whether it contains images.
No. of messages	You can display the number of saved templates.
Delete (Delete this)	▶ <b>Delete this</b> ▶ <b>YES</b>
Delete (Delete selected)	▶ <b>Delete selected</b> ▶ <b>Put a check mark for templates to be deleted</b> ▶  <b>(Finish)</b> ▶ <b>YES</b>
Delete (Delete all)	▶ <b>Delete all</b> ▶ <b>Enter your Terminal Security Code</b> ▶ <b>YES</b>

### Function Menu of the Detailed Template Display

Function menu	Operation/Explanation
Compose message	You can compose a Deco-mail message using the contents of the template. Go to step 2 on page 174.
Edit	You can edit the contents of the template and save it. ▶ <b>Edit the text</b> ▶  <b>(Save)</b> ▶ <b>YES or NO</b> <b>YES</b> . . . . Overwrites and saves. <b>NO</b> . . . . Saves as a separate file. ● See step 2 and step 3 on page 178 for how to edit the text. ● See page 163 when the templates are stored to the maximum.
Save insert image	You can save images inserted into the template or Deco-mail text, and set them as the Stand-by display and Wake-up display. ▶ <b>Select an image</b> ▶ <b>YES</b> ▶ <b>Select a destination folder.</b> Go to step 3 on page 160. ● See page 163 when images are stored to the maximum.

### Information

#### <Edit>

- The title name when saved as a separate file takes "YYYY/MM/DD hh:mm" (Y: Year, M: Month, D: Date, h: hour, m: minute).

#### <Save insert image>

- Deco-mail pictograms are saved to the "お気に入り (Favorite)" folder in the "Decomail-pictograph" folder.

### <Attachments>

## Attaching Files

You can send an i-mode mail message with files attached.

You can attach following files:

- Still image
- Melody
- Moving image/i-motion movie
- ToruCa file
- PDF file
- Phonebook entry
- Schedule event
- ToDo item
- Bookmark (i-mode, Full Browser)
- Word
- Excel
- PowerPoint
- SD other files











You can attach up to 10 files within 2 Mbytes in total.

- You cannot attach files that are prohibited from being attached to mail or output from the FOMA phone to other devices.
- Regardless of the "File restriction" setting, you can attach the still image or moving image/i-motion movie shot with your FOMA phone or the files received via infrared rays.
- When you attach a file, another attachment field appears on the Message Composition display.
- Depending on the destination i-mode phone, only the compatible files are received within the memory space of that phone.
- It might take a time to send the i-mode mail depending on the size of attached files.

## 1 Message Composition display

- ▶ **Select the attachment field**
- ▶ **Do the following operations.**

Item	Operation/Explanation
Picture	▶ <b>Select a folder</b> ▶ <b>Select an image.</b> ● Highlight an attached image and press  <b>(Select)</b> to display the image. Press <b>(CLR)</b> to return to the former display.

Item	Operation/Explanation
Melody	<p>▶ <b>Select a folder</b> ▶ <b>Select a melody.</b></p> <ul style="list-style-type: none"> <li>Highlight an attached melody and press  (Select) to play back the melody.</li> </ul> <p>Press any key to stop the playback.</p>
i-motion	<p>▶ <b>Select a folder</b> ▶ <b>Select an i-motion movie.</b></p> <ul style="list-style-type: none"> <li>Highlight the attached i-motion movie and press  (Select) to play back the i-motion movie.</li> </ul> <p>Press  during playback or stop the playback to return to the former display.</p>
ToruCa	<p>When the ToruCa file is a ToruCa file (details), it is attached as a ToruCa file (details).</p> <p>▶ <b>Select a folder</b> ▶ <b>Select a ToruCa file.</b></p> <ul style="list-style-type: none"> <li>Highlight the attached ToruCa file and press  (Select) to preview it. Press  to return to the former display.</li> </ul>
PDF	<p>▶ <b>Select a folder</b> ▶ <b>Select a PDF file.</b></p> <ul style="list-style-type: none"> <li>Highlight an attached PDF file and press  (Select) to display the PDF file. Press  to return to the former display.</li> </ul>
Phonebook	<p>▶ <b>Select a search method</b> ▶ <b>Select a Phonebook entry</b></p> <p> (Select)</p> <ul style="list-style-type: none"> <li>When you specified a search method last time, the Phonebook entry is searched by that method.</li> </ul>
Schedule	▶ <b>Select a date</b> ▶ <b>Select a schedule event</b> ▶  (Select)
ToDo	▶ <b>Select a ToDo item</b> ▶  (Select)
Bookmark	▶ <b>i-mode or Full Browser</b> ▶ <b>Select a bookmark.</b>
Document file	<p>You can attach a file of Word, Excel, and PowerPoint.</p> <p>▶ <b>Select a folder</b> ▶ <b>Select a file.</b></p>
Other	<p>You can attach a file stored in "SD other files".</p> <p>▶ <b>Select a folder</b> ▶ <b>Select a file.</b></p>

**2** Go to step 2 on page 174.

## Information

### <Picture>

- The images are not sent as the attachments to i-mode phones of the mova service; they are in the form of URLs for browsing images and automatically attached with expiry dates and can be obtained by selecting URLs. The mail text that can be sent to an i-mode phone of the mova service is up to 184 full-pitch characters (369 bytes). (When the acceptable number of characters of the mova phone is "250 full-pitch characters")

When multiple files are attached, the files are deleted and just the mail text is sent.

- The i-mode phone of the mova service cannot receive GIF images.
- You can attach a Flash movie as well.
- The still image might not be received correctly or not be displayed or coarsely displayed depending on the model at the receiving end.

### <Melody>

- Melodies stored on the microSD card cannot be attached. Copy the melodies to the FOMA phone. (See page 310)
- If the receiving end is other than FOMA P706ij, the sent melody might not be played back correctly or the attachment might be deleted.
- You cannot receive the attached melody on the i-mode phone of the mova service.

### < i-motion >

- Some i-motion movies cannot be attached to mail or their file sizes may become larger or smaller.
- Moving images stored on the microSD card cannot be attached. Copy the moving images to the FOMA phone. (See page 310)
- Depending on the mobile phone of the receiving end, i-motion movies cannot be correctly received/displayed, might become coarse, or might be converted into consecutive still images.

When sending moving images to other than the 2 Mbytes compatible model, it is advisable to shoot them with the following settings:

File size setting: Mail restrict'n (S)

Image quality: Normal

### <ToruCa>

- ToruCa files stored on the microSD card cannot be attached. Copy the ToruCa files to the FOMA phone. (See page 242)

## Delete Attached File

You can delete a selected attached file or all attached files.

**1** Message Composition display  (FUNC)

▶ Operate att. file ▶ Delete att. file

▶ Delete this or Delete all ▶ YES

- To delete a single file, highlight a file to be deleted.

<Photo-sending>

## Using Photo-sending

You can send photos (still images) to the other party during a voice call. The photo is sent as the attachments of i-mode mail, and the receiving end can view it during a call.

To send photos during a voice call, you need to store the phone number and mail address of the other party in the same Phonebook entry beforehand.

Depending on the model of other party's phone, the other party might not be able to view the photo during a call.

## Shoot and Send Photos

During a voice call, you can send photos (still images) you shoot on the spot.

**1** During a voice call  (FUNC) ▶ Shoot/send photo

▶ Photo mode

The camera starts up.



**2** Press  (Record).

The photo is shot.

- Press  from the Finder display to return to the "Talking" display.
- See page 140 for how to operate on the Finder display.

**3**  (Send) ▶ Select a mail address ▶ OK

The photo is saved and sent.

- You can send it also by pressing  (FUNC) and selecting "Save & send".
- You can set "Set display" and "File restriction" by pressing  (FUNC). (See page 137 and page 142)
- When multiple mail addresses are stored, select the mail address you send the mail message to.
- When you select "Quit", the photo is saved to the Draft as the image-attached mail.

## Information

- The image sizes of the camera are QCIF (176 x 144) and Sub-QCIF (128 x 96).

## Select and Send Photos

You can send the saved photos (still images).

**1** During a voice call  (FUNC) ▶ Shoot/send photo

▶ My picture

**2** Select a folder ▶ Select a photo ▶ Select a mail address  
▶ OK



The photo is sent.

- You can select a photo (still image) of only QCIF (176 x 144) and Sub-QCIF (128 x 96).
- When multiple mail addresses are stored, select the mail address you send the mail message to.

## When you received a photo (still image)

When "Photo auto display" is set to "ON", the photo is automatically displayed.

If you have received multiple photos during a voice call, you can press  to switch them.

- You can display the received photo during a voice call by pressing  (FUNC) and selecting "Display photo".
- You can also execute "Check new msg." during a voice call by pressing  (FUNC). (See page 187)

## Information

- Photo-sending is not available in the following cases:
  - When the phone number and mail address of the other party on the phone are not stored in the same Phonebook entry
  - When the phone number and mail address of the other party on the phone are stored as secret data in the Phonebook
  - When a caller ID is not notified to the receiving end (User unset, PublicPhone, Unavailable etc.) (However, you can send from the calling end.)
  - When "Restrict dialing" is not set for the phone number of the other party on the phone during "Restrict dialing"
  - When sent mail messages in the Outbox are saved to the maximum and all of them are protected, when 20 draft mail messages are saved, or when the Draft is full (You cannot send.)
  - When the Inbox is full of unread or protected mail (You cannot receive.)
  - During Call Waiting
  - In B Mode of 2in1
- You cannot send Flash movies by Photo-sending.
- You cannot send some images by Photo-sending.
- A photo sent/received during a voice call is saved to the Outbox or Inbox as a file attachment of the image mail (the subject is the phone number).

## <Mail Auto-receive>

### Receiving i-mode Mail Automatically

When the FOMA phone is in the service area, you can receive i-mode mail, SMS messages and SMS reports automatically. (See page 186 for receiving i-mode mail after selecting it.)

When a mail message comes in, "☐(white)" appears at the top of the display.

You can save up to 2,500 received i-mode mail messages including SMS messages.

#### 1 When i-mode mail arrives, "☐(white)" blinks and the receiving message is displayed.

When receiving is completed, the display shows the number of received i-mode mail messages and Messages R/F.

- You can display the Inbox list by selecting "Mail".
- To cancel receiving midway, select "Cancel" or press and hold **[CLR]** for at least one second while "Mail Receiving..." is displayed. However, the mail message might be received depending on the timing.
- If no keys are pressed for about 15 seconds, "NEW 1" (see page 107) appears on the desktop and the former display returns. (The transit time varies depending on the setting for "Mail/Msg. ring time".)

Press **[OK]**, highlight "NEW 1", and press **[Select]** to display the Inbox list.



## Information

- You can automatically receive up to 100 Kbytes of an i-mode mail message including attached files. You can manually obtain the attached files in excess of 100 Kbytes from the i-mode Center. (See page 189)
- When the total number or size of received messages stored in the FOMA phone has reached the maximum, the mail messages will be overwritten in the priority order of mail in the "Trash box" folder and older received mail. However, unread or protected mail is not overwritten.

**Information**

- When the total number of unread or protected mail messages in the Inbox has reached the maximum, no new mail can be received and "■" (black) is displayed. To receive i-mode mail, delete received mail or read unread mail or release protection of mail until "■" (black) clears, and then perform "Check new message".
- You can receive i-mode mail with melodies, still images, or other files attached. You can receive incompatible attached files but you cannot display them.
- When you receive mail from a device that can set To, Cc and Bcc, you can check whether the message was sent to you as To, Cc or Bcc.
- Mail Messages received in the following cases are held at the i-mode Center:
  - When the power is off
  - During a videophone call
  - During Self Mode
  - When you are out of the service area
  - During infrared data exchange
  - While connecting to the FirstPass center
  - During Omakase Lock
  - During iC communication
  - While copying to the microSD card
  - While connecting to the Data Storage Center
  - When the space of the Inbox is full with protected or unread messages
- When i-mode mail messages are held at the i-mode Center, "□" (white) appears, and when they are held to the maximum, "■" (black), appears.

**Display Newly Received i-mode Mail**

- 1 Reception Result display ▶ Mail**  
▶ Select an i-mode mail message to be displayed.

- Press and hold  for at least one second from the detailed i-mode mail display to change the size of characters. (See "Mail" on page 111.)

**Information**

- Undisplayable characters are replaced by spaces, etc.

**Information**

- When the number of characters in the text of received i-mode mail exceeds the maximum, "r" or "/" is inserted at the end of the text and the excess part is deleted automatically.
- The still image automatically displayed at opening might not be correctly displayed. When the image is larger than the screen size, it is displayed shrunk with a proportional ratio retained.
- Some decorations inserted into the decorated mail (HTML mail) sent from a personal computer might not be displayed correctly.

**<Receive Option>****Receiving Selected i-mode Mail**

You can check the titles of i-mode mail messages held at the i-mode Center and select them to receive, or delete them at the Center before receiving.

To use this function, set "Receive option setting" to "ON" beforehand. When "Receive option setting" is set to "ON", you cannot receive i-mode mail messages automatically. When a mail message comes in the i-mode Center, "□" is displayed.



**Receive Option Setting**

You can set whether to select and receive necessary i-mode mail only.

- 1**  ▶ Mail settings ▶ Receive option setting ▶ ON or OFF

**Select and Receive Mail Messages**

- 1**  ▶ Receive option ▶ Operate following the procedure described in "Mobile Phone User's Guide [i-mode] FOMA version".

- When "Receive option setting" is set to "OFF", the display to the effect that it will be set to "ON" appears.  
Press  (Select) to set "Receive option setting".
- You can bring up the Receive Option display also by  ▶  Menu  
▶ メニューリスト (Menu List) ▶ メール選択受信 (Receive Option).



### Information

- Even when Receive Option Setting is set to "ON", you will still receive all mail messages if you execute "Check new message". If you do not want to receive all mail messages, remove a check mark from "Mail". (See page 204)
- When you bring up the Receive Option display, the "☑" icon goes off. Also, the "☑" icon goes off if you turn the power off or bring up the mail display.
- You cannot select SMS messages for receiving.

<Check New Message>

## Checking whether Center Holds i-mode Mail

i-mode mail messages and Messages R/F arriving at the i-mode Center are automatically sent to your FOMA phone. However, the messages will be held at the i-mode Center if your FOMA phone cannot receive mail because it is turned off or out of the service area, or when Receive Option Setting is set to "ON".

When "☑(white)" is displayed, receive mail by checking the i-mode Center.

See "Receive option" when "☑" is displayed.

### 1 Press and hold for at least one second.

"☑(white)" and "☑(white)/☑(white)" blink, the message "Checking..." is displayed, and then you receive i-mode mail messages and Messages R/F.

As the checking results, the number of newly received i-mode mail messages and Messages R/F is shown.

- To cancel receiving midway, press and hold  for at least one second. However, the mail message might be received depending on the timing.

### Information

- When icons such as "☑(black)", "☑(black)/☑(black)" or "☑(black)" are displayed, the FOMA phone cannot receive any more i-mode mail messages or Messages R/F. Delete unnecessary mail and messages, or read unread mail and messages, or release protection. (Read and unprotected mail and messages are overwritten automatically from the oldest one.)

### Information

- Even when i-mode mail messages are held at the i-mode Center, the "☑(white)" icon to that effect, or the "☑(black)" icon telling that messages are held to the maximum at the i-mode Center might not appear. (This happens if mail arrives at the Center when, for instance, your FOMA phone is off.)
- You can select items to be checked by "Set check new message".
- You cannot use this function to receive SMS messages. Use "Check new SMS" to receive them.

<Reply> <Reply with Quote>

## Replying to Received i-mode Mail

You can reply to the sender. With "Reply with quote", you can quote the original text in your received i-mode mail and reply to it. You cannot use "Reply with quote" for SMS messages.

### 1 Inbox list/Detailed Received Mail display

▶ Reply/forward ▶ Reply or Reply with quote

- You can reply also by pressing  (Reply).
- If other recipients of the simultaneous mail are found, you can choose whether to reply to the sender only or to all addresses. Select "To sender" or "To all".
- Just one quotation mark (see page 205) is added to the beginning of the text in the i-mode mail to be replied with quote.

### 2 Enter a subject and text, and then send.

When you have selected i-mode mail, go to step 3 on page 174.

When you have selected an SMS message, go to step 3 on page 214.

After you send mail, "☑" changes to "☑".

### Information

- For the sender's address that cannot be replied to (such as when the mail address exceeds 50 half-pitch characters), "Fm" is displayed.
- "Re:" is prefixed to the subject of the mail message to be replied or replied with a quotation. When the subject exceeds 100 full-pitch characters, the excess is deleted. (When "Re:" has already been prefixed, it changes to "Re2." and will be counted up to "Re99:.")

## Information

- Even if the i-mode mail text contains pasted data, you cannot quote it in your reply. Also, you cannot quote it when using the DOCOMO keitai datalink or infrared data exchange function. See page 192 for pasted data.
- If the Deco-mail text contains images prohibited from being attached to mail or being output from the FOMA phone, such images will be deleted when you reply.

<Forward>

## Forwarding Received i-mode Mail

You can forward the i-mode mail or SMS messages to others.

### 1 Inbox list/Detailed Received Mail display (FUNC)

▶ Reply/forward ▶ Forward

- You can forward also by pressing  (Forward) from the Inbox list.

### 2 Enter an address and send the mail.

When you have selected an i-mode mail message, go to step 2 on page 174.

When you have selected an SMS message, go to step 2 on page 214.

After you send mail, " " changes to "".

## Information

- "Fw:" is prefixed to the subject of the mail message to be forwarded. When the subject exceeds 100 full-pitch characters, the excess is deleted. (When "Fw:" has already been prefixed, it changes to "Fw2:" and will be counted up to "Fw99:".)
- When you forward an i-mode mail message with a file you have not obtained yet, the file information is deleted.
- Even if the i-mode mail text contains pasted data, you cannot quote it in your forwarding mail. Also, you cannot quote it when using the DOCOMO keitai datalink or infrared data exchange function. See page 192 for pasted data.
- When a mail message is forwarded and a ToruCa file (details) that contains data whose output from the FOMA phone is prohibited is attached to the mail message, the attached file returns to a ToruCa file before obtaining details.

## Information

- When a mail message on the microSD card is forwarded, the attached file is deleted.
- When you "Forward" a mail/SMS message received to Number B/Address B in Dual Mode of 2in1, the sent mail message is retained in the Outbox or Draft, even if you switch to A Mode.

## When i-mode Mail with Files Attached/ Pasted is Received

You can receive up to 2 Mbytes of the attached files on your FOMA phone. However, you receive only the attached file information for the files in excess of 100 Kbytes, so you need to manually obtain those attached files from the i-mode Center.

The FOMA phone supports following files:

- Still image
- Melody
- Moving image/i-motion movie
- PC movie
- ToruCa file
- PDF file
- Phonebook entry
- Schedule event
- ToDo item
- Bookmark (i-mode, Full Browser)
- Word
- Excel
- PowerPoint

You cannot play back or display the files other than above. You can save them to any folder in "SD other files", or use the i-mode mail to forward them.

You can use "Attachment preference" to select the files to be received.

- When multiple data items are pasted, they might not be displayed.

## Obtain Receive Option Attached Files

You can obtain the receive option attached files held at the i-mode Center.

### 1 Detailed Received Mail display

▶ Select an attached file which has not been obtained.

After obtaining is completed, files are played back/displayed.



### Information

- You cannot obtain the attached files when the unused memory space in the Inbox is smaller than the files.

## Play Back/Display Attached or Pasted Files

You can play back or display the attached/pasted files already obtained.

### 1 Detailed Sent Mail display/Detailed Received Mail display ▶ Select an attached file.

The file is played back or displayed.

- For a PC movie or document file, the confirmation display appears telling that you cannot play it back/display it. Play it back/display it after saving it to the microSD card.
- For the Phonebook entries, schedule events, ToDo items, bookmarks, and files which are not supported by the FOMA phone, the confirmation display appears asking whether to save them.

### Information

- When the sender's device is other than FOMA P706iμ, the received melodies might not be played back correctly.
- When the first attached file is an obtained still image, that still image only is automatically displayed when the mail message is opened. The size of a still image displayed automatically is up to 5M (2592 x 1944) size.
- When the image size is larger than the screen, it is displayed shrunk.

### Information

- You cannot play back a melody in excess of 100 Kbytes.
- You cannot play back a Flash movie in excess of 100 Kbytes.
- You cannot display a ToruCa file in excess of 1 Kbyte and ToruCa file (details) in excess of 100 Kbytes.

## Save Attached or Pasted Files

You can save the attached or pasted files that you have obtained. You can set some files for a ring tone, or an image on the Stand-by display, Wake-up display, or other displays.

### 1 Detailed Sent Mail display/Detailed Received Mail display/Detailed Message R/F display

▶ Highlight an attached file and press  (FUNC)

▶ Operate file ▶ Save attached file ▶ YES

- PC movies are saved to the destination folder in "microSD" folder of "PC Movie".
- Document files are saved to the destination folder in "Document viewer".
- The files not supported by the FOMA phone are saved to the destination folder in "SD other files".
- Even if the files are supported by the FOMA phone, some of them cannot be saved to the FOMA phone depending on the file such as an invalid data file or whose size is too large. In that case, the confirmation display appears asking whether to save it to the microSD card. When you save it, it is saved to a destination folder in "SD other files".
- The confirmation display might appear telling that a part of the file cannot be saved depending on the attached file.

## 2 Select a destination or folder to save to.

For melodies, go to step 2 on page 160.

For still images, go to step 3 on page 160.

For i-motion movies, go to step 2 on page 170.

- Bookmarks are saved according to each information of i-mode or Full Browser.
- If the maximum number of files has already been saved to the microSD card or there is no usable memory space when you save SD other files, PC movies, or document files, the confirmation display appears asking whether to delete unnecessary files to save new files. Select "YES", and select unnecessary files from the displayed list in Data Box to delete them. See page 163 for when files other than "SD other files" have no usable memory space.

### Information

- You cannot save a melody in excess of 100 Kbytes to the FOMA phone.
- You cannot save a Flash movie in excess of 100 Kbytes to the FOMA phone.
- You cannot save a ToruCa file in excess of 1 Kbyte and ToruCa file (details) in excess of 100 Kbytes to the FOMA phone.

<Inbox> <Outbox> <Draft>

## Displaying Mail from Inbox/Outbox/Draft

### Display Mail from Inbox

You can save up to 2,500 received i-mode mail messages including SMS messages.

You can save up to 30 Area Mail messages separately from i-mode mail messages and SMS messages.





You can check the received i-mode mail messages, SMS messages, and Area Mail messages.

## 1 Inbox ▶ Select a folder.

- See page 207 for displaying Messages R/F.



## 2 Select a mail message.

- When you select an unread mail message, " (pink)" changes to " (grey)".
- Use  to check other mail messages.
- When the mail text is long, use  to scroll the display to check it. Also, you can press  /   to scroll page by page.

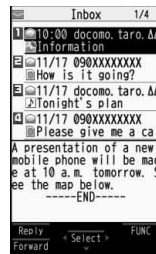

### Information

- The attached melody and effect tone of the Flash movie in mail text sound following the setting of "Auto melody play". However, when a mail message with an attached melody includes the effect tone of the Flash movie in mail text, the melody is preferentially played back. The effect tone does not sound.
- The melody and effect tone do not sound during Play Background.

### Display Mail from Outbox

You can save up to 1,000 sent i-mode mail messages including SMS messages.

You can check the sent i-mode mail messages and SMS messages.

## 1 Outbox ▶ Select a folder.

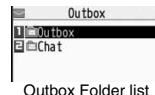

## 2 Select a mail message.

- Use to check other mail messages.
- When the mail text is long, use to scroll the display to check it. Also, you can press / or / to scroll page by page.



Outbox list



Detailed Sent Mail display

## Display Mail from Draft

You can edit and send i-mode mail messages and SMS messages in the Draft. You can save up to 20 i-mode mail messages including SMS messages.

## 1 Draft

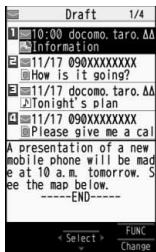

Draft list

## 2 Select a mail message.

When you have selected i-mode mail, go to step 2 on page 174. When you have selected an SMS message, go to step 2 on page 214.

## Information

- When you select the i-appli mail folder, the mail-linked i-appli that supports the folder starts.

## How to See Inbox/Outbox/Draft List and Detailed Display

### Mail menu

Icons might have the following marks:

	Unread mail messages or messages are stored in the Inbox.
	Failed-to-send mail messages are stored in the Outbox. Draft mail messages are stored in the Draft.
	"Mail security" is activated. (displayed also for chat mail)



### Inbox Folder list

#### 1 Folder status

"NEW" appears when unread messages are found, and "F" appears when Mail Security is activated.

	Ordinary folder
	i-appli mail folder
	Message R folder
	Message F folder
	Trash box folder

#### 2 Folder name

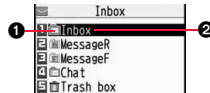

## ■Inbox list and detailed Received Mail display

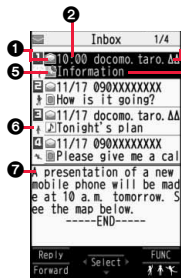

Inbox list  
For "Date+sender/  
receiver subject"

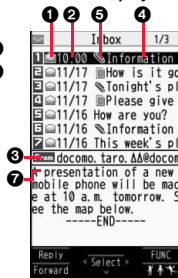

Inbox list  
For "Date+subject"

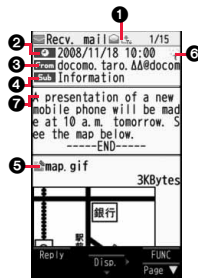

Detailed Received  
Mail display

## 1 Mail status and type

"🔒" appears when protection is set.

	Unread mail
	Read mail
	Forwarded mail
	Replied mail
	Type of the received mail (Detailed display only)

## 2 Received date and time

The Inbox list shows the time for the mail received today, and shows the date for the mail received until yesterday. The detailed display shows the date and time the mail was received. The Japanese date and time the mail was received from the Center is displayed.

## 3 Phone number or mail address of the sender or of another recipient of simultaneous mail

	Sender's mail address (Detailed display only)
	Sender's mail address that cannot be replied to (Detailed display only)
	Recipient's mail addresses of simultaneous mail (Detailed display only)
	Recipient's mail addresses of simultaneous mail that cannot be replied to (Detailed display only)

## 4 Subject

When "Mail list display" is set to "Date+sender/receiver subject", the subject is displayed up to 11 full-pitch/22 half-pitch characters. When set to "Date+subject", it is displayed up to 7 full-pitch/14 half-pitch characters, however, for a mail message with files attached, it is decreased by 1 full-pitch/2 half-pitch character/s as the icon is added at the top.

For SMS messages or Area Mail messages, the beginning of the text is displayed.

("SMS" or "Area Mail" is displayed on the detailed display.)

In Dual Mode of 2in1, "📧" is displayed at the end of the subject or sender's address of SMS/i-mode mail messages received to Number B/Address B.

	SMS messages in the FOMA phone
	SMS messages on the UIM

	Area Mail
--	-----------

## 5 Attached or pasted data

The detailed display shows the data volume as well.

<For Inbox list (Date+sender/receiver subject) and detailed Received Mail display>

"🗑️" is added to each icon when you execute "Delete att. file" (Detailed display only).

	Melody file
	Image file
	Inserted image file (List only)
	i-motion movie file
	PC movie file
	ToruCa file
	PDF file
	Document file
	Phonebook entry file
	Schedule event or ToDo item file
	Bookmark file
	Other files

	Attached file before obtaining (Detailed display only)
	Attached file suspended to be obtained (Detailed display only)
	Attached file failed to be obtained (Detailed display only)
	i-oppli start information (List only)
	i-oppli mail (List only)
	Multiple files (List only)
	Multiple pasted files
	File with the UIM security

<For Inbox list (Date+subject) (Date+sender/receiver)>

	Attached file
	i-oppli mail

	File with the UIM security
--	----------------------------

## 6 Feel \* Mail icon

When you press from Inbox list, the Feel \* Mail image is played back.

See page 104 for Feel \* Mail.

## 7 Text of mail

### ■ Outbox Folder list

#### 1 Folder status

"5" appears when Mail Security is activated.

	Ordinary folder
	i-oppli mail folder

#### 2 Folder name

### ■ Outbox list and detailed Sent Mail display

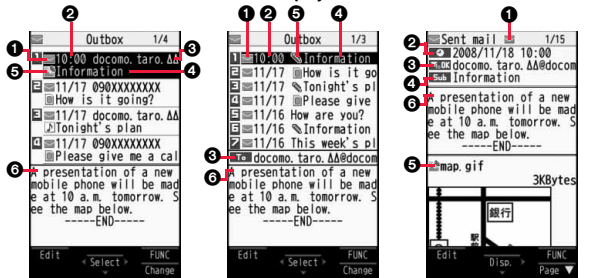

Outbox list  
For "Date+sender/  
receiver subject"

Outbox list  
For "Date+subject"

Detailed Sent Mail  
display

#### 1 Mail status

"🔒" appears when protection is set.

	Mail successfully sent
	Mail failed to be sent
	Simultaneous mail successfully sent to all addresses
	Simultaneous mail sent to some addresses
	Simultaneous mail failed to be sent to all addresses

#### 2 Sent date and time

The Outbox list shows the time for the mail sent today, and shows the date for the mail sent until yesterday. The detailed display shows the date and time the mail was sent.

"🕒" appears when the date/time is corrected.

## 3 Recipient's phone number or mail address

			Mail address successfully sent (Detailed display only)
			Mail address failed to be sent (Detailed display only)

## 4 Subject

When "Mail list display" is set to "Date+sender/receiver subject", the subject is displayed up to 11 full-pitch/22 half-pitch characters. When set to "Date+subject", it is displayed up to 7 full-pitch/14 half-pitch characters, however, for a mail message with files attached, it is decreased by 1 full-pitch/2 half-pitch character/s as the icon is added at the top.

For SMS messages, the beginning of the text is displayed. ("SMS" is displayed on the detailed display.)

	(blue)	SMS messages in the FOMA phone		SMS report received [List (Date+sender/receiver subject) and detailed display only]
		SMS messages on the UIM		

## 5 Attached data

The detailed display shows the data volume as well.

<For Outbox list (Date+sender/receiver subject) and detailed Sent Mail display>

"🗑️" is added to each icon when you execute "Delete att. file" (Detailed display only).

	Melody file		Phonebook entry file
	Image file		Schedule event or ToDo item file
	Inserted image file (List only)		Bookmark file
	i-motion movie file		Other files
	PC movie file		i-oppli mail (List only)
	ToruCa file		Multiple files (List only)
	PDF file		File with the UIM security
	Document file		

<For Outbox list (Date+subject) (Date+sender/receiver)>

	Attached file		File with the UIM security
	i-oppli mail		

## 6 Text of mail

## Draft list

### 1 Mail status

	Ordinary mail
	Simultaneous mail

### 2 Saved date and time

The Draft list shows the time for the mail saved today, and shows the date for the mail saved until yesterday. "" appears when the date/time is corrected.

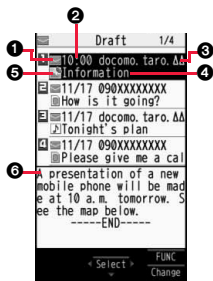

For "Date+sender/receiver subject"

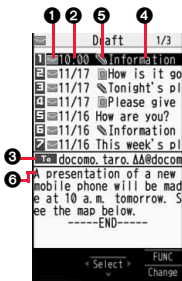

For "Date+subject"

### 3 Recipient's phone number or mail address

When the phone number or mail address is stored in the Phonebook, the name stored in the Phonebook is displayed.

### 4 Subject

When "Mail list display" is set to "Date+sender/receiver subject", the subject is displayed up to 11 full-pitch/22 half-pitch characters. When set to "Date+subject", it is displayed up to 7 full-pitch/14 half-pitch characters, however, for a mail message with files attached, it is decreased by 1 full-pitch/2 half-pitch character/s as the icon is added at the top.

For SMS messages, the beginning of the text is displayed.

	SMS messages
--	--------------

### 5 Attached data

<For Date+sender/receiver subject>

	Melody file
	Image file
	Inserted image file
	i-motion movie file
	PC movie file
	ToruCa file
	PDF file
	Document file

	Phonebook entry file
	Schedule event or ToDo item file
	Bookmark file
	Other files
	Multiple files (List only)
	File with the UIM security

<For (Date+subject) (Date+sender/receiver)>

	Attached file
	File with the UIM security

### 6 Text of mail



#### Information



- See "Mail list display" on page 204 to change a method to display the Inbox/Outbox/Draft list.
- When "Name in phonebook" of "Mail list display" is checked, the name stored in the Phonebook is displayed as sender or recipient. However, when the sender's mail address is "phone number@docomo.ne.jp", the name is not displayed even when "phone number@docomo.ne.jp" is stored in the mail address field in a Phonebook entry. Store the phone number part only to display the name. When a sender's/recipient's phone number or mail address matches a Phonebook entry stored as secret data, the name is not displayed. It is displayed in Secret Mode or Secret Data Only. Even when a sender's/recipient's phone number or mail address matches a Phonebook entry not stored as secret data, the name is not displayed in Secret Data Only. Switch to Secret Mode or release Secret Data Only to display the name.
- When "Message" of "Mail list display" is not checked, the text does not appear on the Inbox/Outbox/Draft list.



# Managing Mail Messages

## Function Menu of the Inbox Folder List/Outbox Folder List

Function menu	Operation/Explanation
<b>Operate folder (Add folder)</b>	You can add a new folder. You can add up to 22 folders to each of "Inbox" and "Outbox". ▶ <b>Add folder</b> ▶ <b>Enter a folder name.</b> ● You can enter up to 10 full-pitch/20 half-pitch characters.
<b>Operate folder (Edit folder name)</b>	You can edit the names of the added folders only. ▶ <b>Edit folder name</b> ▶ <b>Edit the folder name.</b> ● You can enter up to 10 full-pitch/20 half-pitch characters.
<b>Operate folder (Sort folder)</b>	You can sort folders. You can sort the added folders, Message R/F folder, and the i- <i>oppli</i> mail folders. ▶ <b>Sort folder</b> ▶ Use  <b>to sort the order</b> ▶  <b>Select</b>
<b>Operate folder (Delete folder)</b>	All the mail messages including secret mail in the folder will be deleted as well. ▶ <b>Delete folder</b> ▶ <b>Enter your Terminal Security Code</b> ▶ <b>YES</b>
<b>Open folder</b>	You can display the mail messages in the i- <i>oppli</i> mail folder without running mail-linked i- <i>oppli</i> .
<b>Read all [Inbox Folder only]</b>	You can change unread mail in the folder to already-read mail. ▶ <b>YES</b>
<b>Sort (Auto-sort)</b>	See page 201.
<b>Sort (Re-sort)</b>	You can resort mail messages following the sorting conditions specified by "Auto-sort". ▶ <b>Re-sort</b> ▶ <b>YES</b> ● When the folder applied with Mail security (see page 195) is found, you need to enter your Terminal Security Code.
<b>Mail security</b>	You can set the folder to open only when you enter your Terminal Security Code. ▶ <b>Enter your Terminal Security Code</b> ▶ <b>YES</b> ● To release it, perform the same operation.

Function menu	Operation/Explanation
<b>lr/  transmission (Send all lr data)</b>	See page 320.
<b>lr/  transmission (All  transmission)</b>	See page 322.
<b>No. of messages</b>	You can display the number of stored received mail messages, Messages R/F, and sent mail messages.
<b>Delete (DEL all read mails) [Inbox Folder only]</b>	You can delete all the read mail messages including secret mail in all Inbox folders. All the read SMS messages on the UIM are deleted as well. ▶ <b>DEL all read mails</b> ▶ <b>YES</b>
<b>Delete (DEL all recv. mails) [Inbox Folder only]</b>	You can delete all the mail messages including secret mail in all Inbox folders. All the received SMS messages on the UIM are deleted as well. ▶ <b>DEL all recv. mails</b> ▶ <b>Enter your Terminal Security Code</b> ▶ <b>YES</b>
<b>DEL all sent mails [Outbox Folder only]</b>	You can delete all the mail messages including secret mail in all Outbox folders. All sent SMS messages on the UIM are deleted as well. ▶ <b>Enter your Terminal Security Code</b> ▶ <b>YES</b>

### Information

#### <Operate folder (Delete folder)>

- You cannot delete an i-*oppli* mail folder if corresponding mail-linked i-*oppli* exists. If the software program does not exist, you can delete the i-*oppli* mail folder, but this will delete both folders created in the Outbox Folder list and Inbox Folder list.

#### <Sort (Re-sort)>

- You cannot re-sort the mail messages in the "Chat" folder and "Trash box" folder.
- Mail messages which are not applied with "Auto-sort" are sorted into the "Inbox" folder.

#### <Mail security>

- You can neither delete the Mail-Security-activated folder nor edit its name.

## Function Menu of the Inbox List/Outbox List/Draft List

Function menu	Operation/Explanation
<b>Reply/forward (Reply)</b> [Inbox only]	See page 187.
<b>Reply/forward (Reply with quote)</b> [Inbox only]	See page 187.
<b>Reply/forward (Forward)</b> [Inbox only]	See page 188.
<b>Edit</b> [Outbox only]	You can re-edit the sent mail message and send it again. When you have selected an i-mode mail message, go to step 2 on page 174. When you have selected an SMS message, go to step 2 on page 214.
<b>Protect (Protect ON/OFF)</b> [Inbox/Outbox]	You can protect the mail message so that it is not overwritten and deleted. You can protect all the received and sent messages. (2,500 received messages, 1,000 sent messages) The protected one is indicated by "🔒". ▶ <b>Protect ON/OFF</b> • To release protection, perform the same operation. • You can switch between protected and unprotected also by pressing <b>1</b> from the detailed Received Mail display or detailed Sent Mail display.
<b>Protect (ProtectSLCT. ON/OFF)</b> [Inbox/Outbox]	▶ <b>ProtectSLCT. ON/OFF ▶ Put/Remove a check mark for mail messages to be protected/unprotected</b> ▶ <b>(Finish)</b> • A check mark is placed to the mail already protected.
<b>Move/copy (Move)</b> [Inbox/Outbox]	▶ <b>Move ▶ Select a destination folder</b> ▶ <b>Put a check mark for mail messages to be moved</b> ▶ <b>(Finish) ▶ YES</b>

Function menu	Operation/Explanation
<b>Move/copy (Move to trash)</b> [Inbox only]	You can move mail messages to the "Trash box" folder. The mail messages moved to the "Trash box" folder are preferentially overwritten (deleted). ▶ <b>Move to trash ▶ Put a check mark for mail messages to be moved to the trash box</b> ▶ <b>(Finish) ▶ YES</b>
<b>Move/copy (UIM operation)</b> [Inbox/Outbox]	You can copy or move the mail message to the UIM or FOMA phone. (See page 370)
<b>Move/copy (Copy to microSD)</b>	See page 307.
<b>Move/copy (Store in Center)</b>	You can save mail messages stored in FOMA phone to the Data Storage Center. Data Security Service is a pay service that is available on a subscription basis. ▶ <b>Store in Center ▶ Enter your Terminal Security Code</b> ▶ <b>Put a check mark for mail messages to be saved</b> ▶ <b>(Finish) ▶ YES</b> • You can select up to 10 mail messages. • You do not need to put a check mark for the mail messages on the detailed Received Mail display and detailed Sent Mail display.
<b>Search/sort (Search sender/ Search receiver)</b> [Inbox/Outbox]	You can retrieve mail messages with a mail address or phone number of a sender or recipient. "Search sender" for received mail and "Search receiver" for sent mail are displayed respectively. ▶ <b>Search mail ▶ Search sender or Search receiver</b> ▶ <b>Select an item.</b> <b>Phonebook</b> . . . . . Call up a Phonebook entry and select a phone number or mail address. <b>Received address</b> . . . Select a phone number or mail address and press <b>(Select)</b> . <b>Sent address</b> . . . . . Select a phone number or mail address and press <b>(Select)</b> . <b>Enter address</b> . . . . . Enter the mail address or phone number. • You can enter up to 50 half-pitch characters.

Function menu	Operation/Explanation
<b>Search/sort</b> <b>(Search subject)</b> [Inbox/Outbox]	You can retrieve mail messages with a subject. ▶ <b>Search mail</b> ▶ <b>Search subject</b> ▶ <b>Enter a subject.</b> ● You can enter up to 100 full-pitch/200 half-pitch characters.
<b>Search/sort</b> <b>(Search subject+msg)</b> [Inbox/Outbox]	You can retrieve mail messages with a subject or text. ▶ <b>Search mail</b> ▶ <b>Search subject+msg</b> ▶ <b>Enter a part of a subject or text.</b> ● You can enter up to 100 full-pitch/200 half-pitch characters.
<b>Search/sort</b> <b>(Sort)</b> [Inbox/Outbox]	You can change the order of displayed mail messages. ▶ <b>Sort</b> ▶ <b>Select an order.</b>
<b>Search/sort</b> <b>(Filter)</b> [Inbox/Outbox]	You can display the mail messages only that satisfy the condition. ▶ <b>Filter</b> ▶ <b>Select a type.</b>
<b>Search/sort</b> <b>(Display all)</b> [Inbox/Outbox]	You can re-display all mail messages in "By date ↑" order after using Search Mail, or the Sort or Filter function. ▶ <b>Display all</b>
<b>Mail history</b> [Inbox/Outbox]	You can display the history of sent/received mail from the sender or to the recipient being selected or displayed. Up to 1,000 histories are displayed in the chronological order from the most recent one. ▶ <b>Select a sender's or destination address.</b> The target sent/received mail histories are displayed. ← . . . . Sent mail → . . . . Received mail ● Select a history; then you can bring up the detailed Received Mail display or detailed Sent Mail display. Press <b>(CLR)</b> to return to the former display. ● You can display also by pressing <b>(Z)</b> on the detailed Received Mail display or detailed Sent Mail display.

Function menu	Operation/Explanation
<b>Color label</b> [Inbox/Outbox]	You can color the characters on the Inbox list and Outbox list for classifying mail. Select "Default" to set ordinary character color. ▶ <b>Select a color.</b>
<b>List setting</b>	You can select the item to be displayed on the list. You can also switch between the name stored in the Phonebook and the mail address/phone number for the display in the sender's/destination address field. You can set to list the mail messages by subject depending on the setting of "Mail list display". ▶ <b>Select an item to be displayed.</b> ● You can switch each time you press <b>(Change)</b> from the Outbox list and Draft list.
<b>Ir/ transmission</b> <b>(Send Ir data)</b>	See page 319.
<b>Ir/ transmission</b> <b>(Send all Ir data)</b> [Draft only]	See page 320.
<b>Ir/ transmission</b> <b>( transmission)</b>	See page 321.
<b>Ir/ transmission</b> <b>(All transmission)</b> [Draft only]	See page 322.
<b>No. of messages</b>	You can display the number of stored received mail messages, sent mail messages and draft mail messages.
<b>Delete</b> <b>(Delete this)</b>	▶ <b>Delete this</b> ▶ <b>YES</b>
<b>Delete</b> <b>(Delete selected)</b>	▶ <b>Delete selected</b> ▶ <b>Put a check mark for mail messages to be deleted</b> ▶ <b>(Finish)</b> ▶ <b>YES</b>
<b>Delete</b> <b>(Delete read mails)</b> [Inbox only]	You can delete all the read mail messages in the folder. ▶ <b>Delete read mails</b> ▶ <b>YES</b>

Function menu	Operation/Explanation
<b>Delete</b> <b>(Delete all SMS-R)</b> [Inbox only]	You can delete all the SMS reports. While SMS reports are displayed by the Search Mail function or Filter function, only the displayed SMS reports are deleted. ▶ <b>Delete all SMS-R</b> ▶ <b>Enter your Terminal Security Code</b> ▶ <b>YES</b>
<b>Delete</b> <b>(DEL all frm folder)</b> [Inbox/Outbox]	You can delete all mail messages in the folder. ▶ <b>DEL all frm folder</b> ▶ <b>Enter your Terminal Security Code</b> ▶ <b>YES</b>
<b>Delete</b> <b>(Delete all)</b> [Draft only]	You can delete all the draft mail messages. ▶ <b>Delete all</b> ▶ <b>Enter your Terminal Security Code</b> ▶ <b>YES</b>

### Information

#### <Edit>

- To use "Mail group" for destination addresses, delete all the entered addresses, press  (Finish) to complete the deletion, and then re-select the address field.

#### <Protect>

- You cannot protect mail messages in the "Trash box" folder.
- If you protect all the sent messages which are stored to the maximum, you can no longer compose i-mode mail messages.

#### <Move/copy (Move to trash)>

- If you move unread mail to the Trash box, it changes to read mail.

#### <Move/copy (Store in Center)>

- You cannot save the SMS messages stored on the UIM.
- You cannot save the files attached to mail.
- You cannot use Data Security Service when you are out of the service area.
- When you have not signed up for Data Security Service, the message to that effect appears.
- You can download the mail messages saved to the Data Security Center from its site to your FOMA phone. For details, refer to "Mobile Phone User's Guide [i-mode] FOMA version".

#### <Search/sort>

- Even if you set "No title" for "Search subject" of "Search mail", you cannot search for the i-mode mail whose subject is not entered and displayed as "No title".

### Information

#### <Color label>

- Color Label applied to the mail messages is released when they are copied to the microSD card, copied/moved to the UIM, copied/moved from the UIM or sent via infrared rays or iC transmission.
- Color Label applied to the SMS messages on the UIM is released when the UIM is dismounted and then mounted.

### Function Menu of the Detailed Received Mail Display/ Detailed Sent Mail Display

Function menu	Operation/Explanation
<b>Reply/forward</b> <b>(Reply)</b> [Received Mail only]	See page 187.
<b>Reply/forward</b> <b>(Reply with quote)</b> [Received Mail only]	See page 187.
<b>Reply/forward</b> <b>(Forward)</b> [Received Mail only]	See page 188.
<b>Edit</b> [Sent Mail only]	See page 196.
<b>Resend</b> [Sent Mail only]	You can re-send the sent mail message. ▶ <b>YES</b>
<b>Protect ON/OFF</b>	See page 196.
<b>Move/copy</b> <b>(Copy)</b>	▶ <b>Copy</b> ▶ <b>Select an item to be copied.</b> • See page 381 for how to copy. • When the addresses of the sender and another recipient of simultaneous mail are found or the multiple destination addresses are found, select a mail address or phone number to be copied.
<b>Move/copy</b> <b>(Move)</b>	▶ <b>Move</b> ▶ <b>Select a destination folder.</b>

Function menu	Operation/Explanation
<b>Move/copy (Move to trash)</b> [Received Mail only]	You can move the mail to the "Trash box" folder. The mail messages moved to the "Trash box" folder are preferentially overwritten (deleted). ▶ <b>Move to trash</b> ▶ <b>YES</b>
<b>Move/copy (UIM operation)</b>	You can copy or move the mail to the UIM or FOMA phone. (See page 370)
<b>Move/copy (Copy to microSD)</b>	See page 307.
<b>Move/copy (Store in Center)</b>	See page 196.
<b>Operate file (Save attached file)</b>	See page 189.
<b>Operate file (Save insert image)</b>	See page 182.
<b>Operate file (Save D-pictograph)</b> [Received Mail only]	You can save Deco-mail pictograms in the mail text at once. You can save up to 20 of them. ▶ <b>Save D-pictograph</b> ▶ <b>YES</b> ● See page 163 for when the Deco-mail pictograms are stored to the maximum. ● See page 282 for how to check the stored Deco-mail pictograms.
<b>Operate file (Save as template)</b>	You can save the sent/received Deco-mail message as a template. ▶ <b>Save as template</b> ▶ <b>YES</b> ● See page 163 for when the templates are stored to the maximum. ● See page 181 for how to check the stored template.
<b>Operate file (Property)</b>	You can display the file name and file size of the image inserted into the text. ▶ <b>Property</b> ▶ <b>Select an image.</b>
<b>Operate file (Delete att. file)</b>	▶ <b>Delete att. file</b> ▶ <b>YES</b>

Function menu	Operation/Explanation
<b>Store (Store address)</b>	See page 82.
<b>Store (Add to phonebook)</b>	See page 82.
<b>Store (Auto-sort)</b>	You can store a sender or subject as a sort condition. (See page 201)
<b>Store (Add desktop icon)</b>	See page 109.
<b>Mail history</b>	See page 197.
<b>Color label</b>	See page 197.
<b>Display (Name/address)</b>	You can display the sender's/destination address by the name stored in the Phonebook or by the mail address/phone number. ▶ <b>Name/address</b> ● You can switch also by pressing <b>(5)</b> .
<b>Display (Scroll)</b>	See page 204.
<b>Display (Character size)</b>	See "Mail" on page 111.
<b>Display SMS report</b> [Sent Mail only]	You can check the result of the SMS message you sent, or the date and time it arrived at the destination. To receive the SMS report, set "SMS report request" to "ON".
<b>Ir/ transmission (Send Ir data)</b>	See page 319.
<b>Ir/ transmission ( transmission)</b>	See page 321.
<b>Delete</b>	▶ <b>YES</b> ● You can delete the mail message also by pressing <b>(O)</b> .

**Information**

## &lt;Resend&gt;

- If you re-send a failed-to-send mail message, it is saved as the sent mail message. If you re-send the failed-to-send simultaneous message to all addresses, it is saved as the sent mail message.

## &lt;Sent Address&gt; &lt;Received Address&gt;





**Displaying Sent/Received Mail Record**





Sent and received i-mode mail messages and SMS messages are stored in Sent Address and Received Address, up to 30 messages each. You can check the list for the mail addresses and phone numbers. When you exchange mail messages with the same mail address or phone number, the older one is deleted.

- In Dual Mode of 2in1, up to 60 records for Number A/Address A and Number B/Address B are stored in Received Address in total.

**1****When Using Sent Address**





Press and hold  for at least one second.



-  SMS : SMS message successfully sent
-  i-mode mail : i-mode mail successfully sent
-  SMS : SMS message failed to be sent
-  i-mode mail : i-mode mail failed to be sent
-  : Time-difference corrected time

- Press  () from the Sent Address list to display Redial. When the Sent Address list is displayed from Dialed Calls, you can press  () to display Dialed Calls.

**When Using Received Address**

Press and hold  for at least one second.

-  SMS message
-  i-mode mail
-  : Time-difference corrected time
-  : SMS/i-mode mail message received to Number B/Address B (only in Dual Mode of 2in1)

- Press  () from the Received Address list to display Received Calls.

Sent address 1/2	
11/18 10:00	MAIL
docomo_taro_AA@docomo.	
11/17 23:00	SPES
i@90XXXXXXXXXX	
11/17 19:00	MAIL
DOCOMO_Taro	







Sent Address list

Received address 1/2	
11/18 10:00	MAIL
+ docomo_taro_AA@docomo.	
11/17 23:00	SPES
i@90XXXXXXXXXX	
11/17 19:00	MAIL
+DOCOMO_Taro	



Received Address list

**2** Select a record to be displayed.

The detailed display of the Address list is displayed.

- With an SMS message for which the other party's phone number is not notified, the reason for no caller ID is displayed.
- To send i-mode mail to the displayed address, press   and go to step 3 on page 174. To send an SMS message to the displayed phone number, press   and go to step 3 on page 214.
- To store in the Phonebook, press  () . Go to step 2 of "Storing Displayed Phone Number/Mail Address in Phonebook" on page 82.

**Function Menu while Sent/Received Address is Displayed**

Function menu	Operation/Explanation
<b>Character size</b>	You can switch the character size for the list. (See "Dialed/recv. calls" on page 111)
<b>Feel * Mail</b> [Received Address only]	The Feel * Mail image is played back. See page 104 for Feel * Mail. • You can play back the Feel * mail image also by pressing  (   ).
<b>Add to phonebook</b>	See page 82.
<b>Add desktop icon</b>	See page 109.
<b>Compose message</b>	You can compose an i-mode mail message. The mail address is entered in the address field. Go to step 3 on page 174.
<b>Compose SMS</b>	You can compose an SMS message. The phone number is entered into the address field. Go to step 3 on page 214.

Function menu	Operation/Explanation
Dialing	<p>If the mail address has been stored in a Phonebook entry, you can make a voice call or videophone call to the phone number stored in the Phonebook.</p> <p>▶ <b>Select a dialing type.</b></p> <ul style="list-style-type: none"> <li>When you select "Select image", select an image to be sent to the other party during a videophone call. To cancel the setting, select "Release".</li> <li>When multiple phone numbers are stored in a Phonebook entry, you can dial the first phone number.</li> </ul> <p>▶ <b>Dial</b></p> <ul style="list-style-type: none"> <li>To make an international call, select "Int'l dial assist", select an international call access code, and follow the procedure above after selecting "Dialing" from the Function menu. (See page 59)</li> <li>To set Caller ID Notification, select "Notify caller ID". (See step 2 on page 56)</li> </ul>
Redial/Dialed calls [Sent Address only]	You can display the Redial list or the Dialed Call list.
Received calls [Received Address only]	You can display the Received Call list. All received calls (all calls) are displayed.
Delete this	▶ YES
Delete selected	▶ Put a check mark for records to be deleted ▶  (Finish)
Delete all	▶ Enter your Terminal Security Code ▶ YES

<Auto-sort>

## Sorting Mail Automatically to Each Folder

You can automatically save the mail messages that satisfy the set conditions to the specified folder. This function applies to only the added folders and i-appli mail folders.

### 1 Inbox Folder list/Outbox Folder list ▶ (FUNC) ▶ Sort ▶ Auto-sort

Follow the operation of the Function menu list on page 202 to set "Auto-sort".  
If you select a folder for which Auto-sort conditions have been set, the Auto-sort Setting display appears.

### Auto-sort Storing

You can specify a sort condition and folder from the detailed Sent/Received Mail display.

### 1 Detailed Sent Mail display/Detailed Received Mail display ▶ (FUNC) ▶ Store ▶ Auto-sort ▶ Do the following operations.

Item	Operation/Explanation
Address sort	<p>You can set the displayed sender's/recipient's address for a sorting condition.</p> <p>▶ <b>Select a folder.</b></p> <ul style="list-style-type: none"> <li>When multiple addresses are found, select an address.</li> </ul>
Subject sort	<p>You can edit the displayed subject and set it for a sorting condition.</p> <p>▶ <b>Edit the subject</b> ▶ <b>Select a folder.</b></p>

### To change the condition

The confirmation display appears asking whether to change the condition or to overwrite it.

Select "YES" to release the set condition and set the new one.

### When the same condition is set for another folder

The confirmation display appears asking whether to change the condition. Select "YES" to release the condition set for another folder and to set it for the selected folder.

- You cannot change the setting for a Mail-Security-activated folder.



### When storing another address for the folder set for "Address sort"

The confirmation display appears asking whether to add the address.

#### Information

- You can store a total of 700 addresses in all folders.
- When multiple conditions match, sorting is done in the priority below.
  - 1 Sort all
  - 2 Subject sort
  - 3 Reply impossible/Send impossible
  - 4 Address sort (Look-up address/Enter address)
  - 5 Address sort (Look-up mail group)
  - 6 Address sort (Look-up group)
- Mail messages sent simultaneously to multiple members cannot be sorted by "Address sort" or "Send impossible".
- Area Mail messages are not sorted by "Address sort".

### Function Menu of the Auto-sort Setting Display

Function menu	Operation/Explanation
<b>Address sort (Look-up address)</b>	You can look up a mail address or phone number in the Phonebook or Received/Sent Address and set it to the folder for sorting. ▶ <b>Look-up address</b> ▶ <b>Select an item.</b>
<b>Phonebook</b> . . . . .	Call up a Phonebook entry and select a phone number or mail address.
<b>Received address</b> . . .	Select a phone number or mail address and press  ( <b>Select</b> ).
<b>Sent address</b> . . . . .	Select a phone number or mail address and press  ( <b>Select</b> ).

Function menu	Operation/Explanation
<b>Address sort (Look-up group)</b>	You can set a group to be sorted into the folder. ▶ <b>Look-up group</b> ▶ <b>Select a group.</b>
<b>Address sort (Look-up mail group)</b>	You can set a mail group to be sorted into the folder. ▶ <b>Look-up mail group</b> ▶ <b>Select a mail group.</b>
<b>Address sort (Enter address)</b>	You can directly enter a mail address or phone number to be sorted into the folder. ▶ <b>Enter address</b> ▶ <b>Enter a mail address or phone number.</b> <ul style="list-style-type: none"> <li>• You can enter up to 50 half-pitch characters.</li> <li>• When the mail address is "phone number@docomo.ne.jp", enter the phone number only. You can sort SMS messages as well if you enter the phone number only.</li> </ul>
<b>Subject sort</b>	You can enter the subject of i-mode mail messages to be sorted into the folder. One subject can be set per folder. ▶ <b>Enter a subject.</b> <ul style="list-style-type: none"> <li>• You can enter up to 100 full-pitch/200 half-pitch characters.</li> </ul>
<b>Reply impossible</b>	You can set reply-disabled mail messages to be sorted. You can set for only one folder.
<b>Send impossible</b>	You can set failed-to-send mail messages to be sorted. You can set for only one folder.
<b>Sort all</b>	You can sort all mail messages into the i-ϕpli mail folder. You can set for only one i-ϕpli mail folder each in the Inbox and Outbox. When "Sort all" is set, other sort settings are disabled. ▶ <b>YES</b>
<b>Edit addr/subj</b>	You can edit and store the mail address, phone number, and subject set for the folder. ▶ <b>Edit the mail address, phone number or subject.</b>
<b>List setting</b>	You can switch whether to display the destinations by the name stored in the Phonebook or by the mail address or phone number. ▶ <b>Name or Address</b> <ul style="list-style-type: none"> <li>• You can switch also by pressing  (<b>Change</b>).</li> </ul>



Function menu	Operation/Explanation
<b>Release</b> (Release this)	You can release the sort condition. (The item is deleted from the Auto-sort Setting display.) ▶ <b>Release this</b> ▶ YES
<b>Release</b> (Release selected)	You can select mail addresses or phone numbers, and release the sort condition for them. (The items are deleted from the Auto-sort Setting display.) ▶ <b>Release selected</b> ▶ Put a check mark for mail addresses or phone numbers to be released ▶  (Finish) ▶ YES
<b>Release</b> (Release all)	You can release all sort conditions. (The items are deleted from the Auto-sort Setting display.) ▶ <b>Release all</b> ▶ YES

### Information

#### <Address sort (Look-up group)>

- On the Auto-sort Setting display, "" is added to the top of the name.
- You cannot set groups on the UIM.
- The secret mail messages received in ordinary mode (not in "Secret mode" or "Secret data only") are not sorted into the folder.

#### <Address sort (Look-up mail group)>

- On the Auto-sort Setting display, "" is added to the top of the mail group name.

#### <Subject sort>

- When the subject matches sort conditions for multiple folders, it is sorted to the folder nearest to the "Inbox" folder or "Outbox" folder.
- Even if you set "No title", the i-mode mail titled with "No title" because of no entry cannot be sorted.
- SMS messages cannot be sorted by subject.

#### <Sort all>

- You cannot sort SMS reports or SMS messages that have been directly received on the UIM.

<Mail Group>

MENU 2 6

## Creating Mail Group

You can store mail addresses by group. You can send mail to regular destinations.

You can store up to five addresses per group, and up to 20 groups.

**1** ▶ Phonebook ▶ Phonebook settings ▶ Mail group

▶ Select a Mail Group to be stored.

- When mail addresses are stored in a Mail group, "" appears at the lower left of the display. Press () to compose i-mode mail to a selected Mail group set as the destination address. Go to step 3 on page 174.



**2** Highlight <Not stored> and press

(Edit).

- If you select a stored mail address, the Mail Group Address Confirmation display appears.









**3** Enter a mail address.

- You can enter up to 50 half-pitch characters.
- When you store multiple mail addresses, repeat step 2 and step 3.

### Function Menu of the Mail Group List

Function menu	Operation/Explanation
<b>Compose message</b>	You can compose an i-mode mail message to the Mail group. Go to step 3 on page 174.
<b>Edit group name</b>	▶ Enter a name of the Mail group. • You can enter up to 10 full-pitch/20 half-pitch characters.
<b>Reset group name</b>	You can reset the name of Mail group to the default. ▶ YES



## Function Menu of the Detailed Mail Group Display/Mail Group Address Confirmation Display











Function menu	Operation/Explanation
<b>Edit address</b>	Go to step 3 on page 203. <ul style="list-style-type: none"> <li>You can edit the address also by pressing  .</li> </ul>
<b>Look-up address</b>	You can call up a phone number or mail address in the Phonebook, Sent Address, or Received Address to enter it. <b>▶ Select an item.</b> <b>Phonebook</b> . . . . . Call up a Phonebook entry and select a phone number or mail address. <b>Sent address</b> . . . . . Select a phone number or mail address and press   . <b>Received address</b> . . . . . Select a phone number or mail address and press   .
<b>Delete this</b>	<b>▶ YES</b>
<b>Delete all</b>	<b>▶ Enter your Terminal Security Code ▶ YES</b>

<Mail Settings>

## Setting Mail and Messages R/F

**1**  **▶ Mail settings ▶ Do the following operations.**

Item	Operation/Explanation
<b>Scroll</b>	You can set the number of lines that are scrolled at a time for when you press  from the detailed mail display, detailed Message R/F display, Message Composition display and preview display. <b>▶ Select the number of lines.</b>
<b>Character size</b>	See "Mail" on page 111.
<b>Mail list display</b>	You can set items to be displayed on the Inbox/Outbox/Draft list by using radio buttons or check boxes. <b>▶ Select a display format ▶</b>   .

Item	Operation/Explanation
<b>Message display</b>	You can set whether to display received mail in standard display (from the top) or from the text. <b>▶ Standard or From message</b>
<b>Mail security</b>	See page 121.
<b>Secret mail display</b>	See page 121.
<b>Auto color label</b>	You can specify the text color of the sender, received date/time and others on the Inbox list by mail address. You can store up to 10 items. <b>▶ &lt;Not stored&gt; ▶ Select an item.</b> <b>Phonebook</b> . . . . . Call up a Phonebook entry and select a phone number or mail address. <b>Sent address</b> . . . . . Select a phone number or mail address and press   . <b>Received address</b> . . . . . Select a phone number or mail address and press   . <b>Enter address</b> . . . . . Enter a mail address or phone number. <ul style="list-style-type: none"> <li>To change the set color, press   and select "Select color".</li> <li>To delete the set item, press   and select "Delete" → "Delete this" or "Delete all" and select "YES". If you select "Delete all", you need to enter your Terminal Security Code.</li> </ul> <b>▶ Select a color.</b>
<b>Pred. conv. at reply</b>	You can set whether to preferentially display the words contained in the subject and text of the received mail message as conversion candidates when you reply to, reply with quote to, or forward it. <b>▶ ON or OFF</b>
<b>Header/signature</b>	See page 205.
<b>Set check new message</b>	You can select items to be checked from among i-mode mail, Message R and Message F, for when you perform "Check new message". <b>▶ Put a check mark for the items to be checked ▶</b>   .

Item	Operation/Explanation
<b>Auto-display</b>	See page 206.
<b>Receiving display</b>	You can set whether to display the Message Receiving and Reception Result displays, even during operation of another function. ▶ <b>Alarm preferred or Operation preferred</b> <b>Alarm preferred</b> ... Prioritizes the Message Receiving and Reception Result displays when you have new mail. <b>Operation preferred</b> ... Prioritizes the display of the current operation when you have new mail.
<b>Receive option setting</b>	See page 186.
<b>Attachment preference</b>	You can set whether to receive the attached file with an i-mode mail message. The attached files for which you remove a check mark are held at the i-mode Center. (The file in excess of 100 Kbytes is held at the i-mode Center, even if you put a check mark for it.) ▶ <b>Put a check mark for items to be received</b>  (Finish) ● Put a check mark for "Tool data" to receive Phonebook entries, schedule events, ToDo items, and bookmarks. ● Put a check mark for "Other" to receive PC movies, document files, and files unsupported by the FOMA phone.
<b>Auto melody play</b>	You can set whether to play back the attached or pasted melodies automatically for when you display the text of received mail, or message R/F. ▶ <b>ON or OFF</b>
<b>Photo auto display</b>	You can set whether to automatically display the photo (still image) received during a call. ▶ <b>ON or OFF</b>
<b>Chat setting</b>	See page 213.
<b>Check settings</b>	You can check each of "Mail settings".

### Information

#### <Message display>

- Even if "From message" is set, the message might not be displayed from the text depending on the number of characters in the text.

### Information

#### <Auto color label>

- Even when you set this function, the text color of the mail message already received does not change.

#### <Set check new message>

- If you do not want to receive Messages R and Messages F by "Check new message", change these settings to "".



#### <Auto melody play>

- You cannot play back attached or pasted melodies during Play Background regardless of the setting of "Auto melody play".

## Header/Signature

You can store a header, signature and quotation mark. Also, you can set whether to automatically paste the header or signature.

- 1  ▶ **Mail settings** ▶ **Header/signature**  
▶ **Do the following operations.**

Item	Operation/Explanation
<b>Header</b>	The header is the sentence such as greeting at the beginning of the text. ▶ <b>Select the header field</b> ▶ <b>Enter a header</b>  (Finish) ● You can enter up to 5,000 full-pitch/10,000 half-pitch characters. ● If you do not want the header to be pasted automatically, select "Insert" to change " <input checked="" type="checkbox"/> " to " <input type="checkbox"/> ". See page 176 for adding a header by mail message.
<b>Signature</b>	The signature is your name and other information, placed at the end of the text. ▶ <b>Select the signature field</b> ▶ <b>Enter a signature</b>  (Finish) ● You can enter up to 5,000 full-pitch/10,000 half-pitch characters. ● If you do not want the signature to be pasted automatically, select "Insert" to change " <input checked="" type="checkbox"/> " to " <input type="checkbox"/> ". See page 176 for adding a signature by mail message.
<b>Quotation marks</b>	The quotation mark is the symbol indicating a quotation from received mail for when you reply to mail. ▶ <b>Enter a quotation mark.</b> ● You can enter up to 10 full-pitch/20 half-pitch characters.

**Information**



- You can set decorations in a header and signature.
- Even if you have put a check mark for "Insert", the header and signature cannot be pasted when you compose i-mode mail for Photo-sending during a call or from a template or i-appli.
- You cannot paste the header, signature, and quotation marks to SMS messages.

<Receive Message R/F>



**Receiving Messages R/F Automatically**

Message services automatically deliver information you want to your FOMA phone.

When your FOMA phone is in the service area, it receives Messages R/F automatically from the i-mode Center.





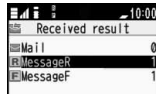

" (white)" or " (white)" appears at the top of the display when a Message R/F is delivered.

You can save up to 100 each of received Messages R/F.

**1 When you receive a Message R/F, the " (white)" or " (white)" blinks and the message for receiving the Message R/F appears.**









After the message is received, the number of received mail messages and Messages R/F is displayed.

- You can display the Message R/F list by selecting "MessageR" or "MessageF".
- If "Auto-display" is set to other than "OFF", the contents of received Message R/F are displayed automatically. They are displayed for 15 seconds when "Mail/Msg. ring time" is set to 0 through 10 seconds, or for the specified duration plus 5 seconds when it is set to 11 seconds or longer.
- If no keys are pressed for the specified duration, " (white)" or " (white)" (see page 107) appears on the desktop and the former display returns. (The transit time varies depending on the setting for "Mail/Msg. ring time".)  
Press , highlight " (white)" or " (white)", and press  (Select) to display the Message R/F list.

**When unread Messages R/F are found**

" (white)" is added to "Message R/F" of i-mode menu.

**Information**

- Received Messages R/F are not automatically displayed while a display other than the Stand-by display is shown, while an i-appli program is running, during Public Mode (Drive Mode), during Lock All, or during Personal Data Lock.
- When the Messages R/F exceeds the maximum number of messages that can be saved, they are overwritten starting from the oldest one. Unread or protected Messages R/F are not overwritten.
- When the FOMA phone cannot receive any more Messages R/F, " (black)" or " (black)" is displayed. Delete unnecessary Messages R/F, read unread Messages R/F or release protection.
- When the icon " (white)" or " (white)" is displayed, the i-mode Center holds Messages R/F. When the icon " (black)" or " (black)" is displayed, the i-mode Center can hold no more Messages R/F. Perform "Check new message" to receive them.
- Even after Messages R/F are displayed automatically, they are still displayed as unread ones in the Message R/F list. However, if you scroll through the messages during automatic display, they will be indicated as read ones.
- Messages R/F received in the following cases are held at the i-mode Center:
  - When the power is off
  - During a videophone call
  - During Self Mode
  - When you are out of the service area
  - During infrared data exchange
  - While connecting to the FirstPass Center
  - During Omakase Lock
  - During iC communication
  - During copy to microSD
  - While connecting to the Data Storage Center
  - When the space for Messages R/F is full with protected or unread messages

**Auto-display**

You can set how to automatically display Messages R/F received during standby.

**1  Mail settings ▶ Auto-display ▶ Select an option for automatic display.**

**Information**

- The Messages R/F are not displayed automatically when "Mail security" is set for "Inbox", or when "Mail security" is set for "MessageR" folder or "MessageF" folder.

<Display Message R/F>

## Reading Received Messages R/F

### 1 Inbox ▶ MessageR or MessageF ▶ Select a Message R/F to be displayed.

- You can display Messages R/F also by ▶ Message R/F ▶ MessageR or MessageF.
- When you select an unread Message R/F, “” (pink) changes to “”.
- Use to check other Messages R/F.
- When the text of Message R/F is long, use to scroll the display to check it. Also, you can press **MENU**(Page )/**OK**(Page ) or / to scroll page by page.

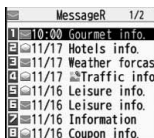

MessageR 1/2

1	10:00	Gourmet info.
2	11/17	Hotels info.
3	11/17	Weather forecast
4	11/17	Traffic info.
5	11/16	Leisure info.
6	11/16	Leisure info.
7	11/16	Information
8	11/16	Coupon info.

Message R/F list

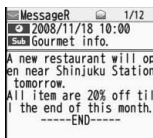

MessageR 1/12

2008/11/18 10:00

Gourmet info.

A new restaurant will open near Shinjuku Station tomorrow.  
All items are 20% off till the end of this month.  
-----END-----

Detailed Message R/F display

### Message R/F list and detailed Message R/F display

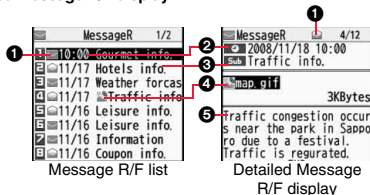

1: Message icon in list

2: Message icon in detailed display

3: Message R/F list

4: Message R/F list

5: Detailed Message R/F display

Message R/F list	Detailed Message R/F display
1 10:00 Gourmet info.	1 2008/11/18 10:00
2 11/17 Hotels info.	2 Traffic info.
3 11/17 Weather forecast	3 Snap.gif
4 11/17 Traffic info.	4 3KBytes
5 11/16 Leisure info.	5 Traffic congestion occurs near the park in Sapporo due to a festival. Traffic is regulated.
6 11/16 Leisure info.	
7 11/16 Information	
8 11/16 Coupon info.	

### 1 Status of Message R/F

“” appears when protection is set.

	Unread Message R/F
	Read Message R/F

### 2 Received date and time

The list shows the time for the Message R/F received today, and shows the date for the Message R/F received until yesterday. The detailed display shows the date and time the Message R/F was received.

### 3 Subject

### 4 The data attached or pasted

The detailed display shows the data volume.

	Valid melody file
	Valid image file
	Valid ToruCa file
	Multiple attached files
	Multiple pasted files
	File with the UIM security

### 5 Text of message

The phone number stored in the Phonebook is displayed by the name stored in the Phonebook.

## Function Menu of the Message R/F List

Function menu	Operation/Explanation
<b>Protect (Protect ON/OFF)</b>	You can protect a Message R/F not to be overwritten or deleted. You can protect up to 50 messages (Message R and Message F each). Protected messages are indicated by “”. ▶ <b>Protect ON/OFF</b> • To release protection, perform the same operation.
<b>Protect (Unprotect all)</b>	▶ <b>Unprotect all</b> ▶ YES
<b>Search/sort (Sort)</b>	You can rearrange the displaying order. ▶ <b>Sort</b> ▶ Select a displaying order.
<b>Search/sort (Filter)</b>	You can display only Messages R/F that satisfy the condition. ▶ <b>Filter</b> ▶ Select a displaying type.
<b>Search/sort (Display all)</b>	After you execute “Sort” or “Filter”, you can reset it and list all Messages R/F by “By date ↑”. ▶ <b>Display all</b>
<b>No. of messages</b>	You can display the total number of Messages R/F stored in the FOMA phone, as well as the number of unread messages and protected messages.

Function menu	Operation/Explanation
Delete (Delete this)	▶ Delete this ▶ YES
Delete (Delete selected)	▶ Delete selected ▶ Put a check mark for Messages R/F to be deleted ▶  (Finish) ▶ YES
Delete (Delete read mails)	You can delete all read Messages R/F. ▶ Delete read mails ▶ YES
Delete (DEL all frm folder)	You can delete all Messages R/F. ▶ DEL all frm folder ▶ Enter your Terminal Security Code ▶ YES

### Information

#### <Search/sort>

- To return to the former status, execute "Display all".
- If you close the list and re-open it, you can return to the list of all items.

### Function Menu of the Detailed Message R/F Display

Function menu	Operation/Explanation
Protect ON/OFF	See page 207.
Operate file (Save attached file)	You can save attached or pasted files. (See page 189)
Operate file (Save insert image)	You can save the attached image and set it as the Stand-by display, Wake-up display, or another display. (See page 182)
Operate file (Save BG image)	▶ Save BG image ▶ YES ▶ Select a destination folder. Go to step 3 on page 160.
Operate file (Save D-pictograph)	You can save the all Deco-mail pictograms inserted into the text. (See page 199)
Add to phonebook	See page 82.
Delete	▶ YES

## What is Early Warning "Area Mail"?

This service enables you to receive reports such as emergency earthquake alerts distributed from the Japan Meteorological Agency.

- You can receive Area Mail messages without i-mode contract.
- You need to set "Receive setting" to receive Area Mail messages.  
※ See page 209 for "Receive setting" of Area Mail.
- You might not be able to receive Area Mail messages in the following cases:
  - During a call (voice call/videophone call)
  - During packet communication (i-mode communication, data communication)
  - During updating software program
- You cannot receive Area Mail messages in the following cases:
  - During Omakase Lock
  - During international roaming
  - During Self Mode
 ※ When you could not receive the messages by the reasons above, you cannot receive them again.

## Receiving Early Warning "Area Mail"

When you receive an Area Mail message, the ring tone for Area Mail sounds. The "Ring volume", "Ring time", and "Vibrator" settings follow those of "Mail".

When you receive an emergency earthquake alert, a dedicated buzzer (alert) sounds, and the vibrator works to notify you. Further, the contents are automatically displayed. "Ring volume" is fixed to "Level 4", and "Vibrator" is fixed to "Melody linkage", so you cannot change their settings. You can use "Area mail settings" to set "Beep time".

Up to 30 Area Mail messages are saved separately from i-mode mail messages and SMS messages in the Inbox.

**1** When an Area Mail message arrives, "" blinks and the message telling its arrival appears.

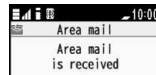

Reception Result display

- If you press any key, the former display returns.
- The contents of some Area Mail messages might be automatically displayed when you receive them. To clear it, press (CLR), or .
- When the automatically-displayed contents remain displayed, the alarm you have set does not work.
- See page 190 for displaying Area Mail messages.

## Information



- The buzzer does not sound when you receive an emergency earthquake alert with the manner setting set by "Manner mode" or "Super silent". However, the buzzer sounds with "Original" set to sound any of the following tones. When every setting is set to mute, the buzzer does not sound:
  - Phone volume
  - Mail volume
  - Alarm volume
  - VM tone
  - Keypad sound
- Even when "Vibrator" of "Original" is set to "OFF", the vibrator works if you receive an emergency earthquake alert.
- When you receive a new Area Mail message with 30 Area Mail messages saved, the read messages are overwritten from the oldest. When all 30 messages are not read, they are overwritten from the oldest one in order.
- Whether the details of a received Area Mail message are displayed or not depends on the setting by the Area Mail message provider.

## <Area Mail Settings>

### Setting Early Warning "Area Mail"

- 1  ► **Area mail settings** ► **Do the following operations.**

Item	Operation/Explanation
Receive setting	You can set whether to use Area Mail. ► <b>Read exemption clause thoroughly</b> ► Yes or No

Item	Operation/Explanation
Receive entry	You can register Message IDs for the reports to be received other than emergency information. You can register up to 20 IDs. <ul style="list-style-type: none"><li>● You do not need to operate "Receive entry" for receiving only emergency earthquake alert and disaster/evacuation information.</li><li>► <b>&lt;New&gt;</b> ► <b>Enter your Terminal Security Code</b></li><li>► <b>Enter a registration name</b> ► <b>Enter a Message ID.</b></li><li>● To edit a registered Message ID, highlight it, press  (  ), and then enter your Terminal Security Code.</li><li>● You can enter up to 15 full-pitch/30 half-pitch characters for an arbitrary registration name. For a Message ID, enter 4 half-pitch characters specified by the service provider.</li><li>● You can edit also by selecting "Edit" from the Function menu. Select "Delete this" to delete the Message ID, and select "Delete all" and enter your Terminal Security Code to delete all Message IDs.</li><li>● You cannot edit/delete "Emergency information".</li></ul>
Beep setting	You can set whether to make the beep sound for when you receive an Area Mail message that beeps. <ul style="list-style-type: none"><li>► <b>ON or OFF</b></li><li>● When you set "OFF", the dedicated ring tone for Area Mail sounds.</li></ul>
Beep time	You can set the duration the beep sounds. <ul style="list-style-type: none"><li>► <b>Enter a beep time (seconds).</b></li><li>● Enter it in two digit, from "01" through "30".</li></ul>

## Using Chat Mail

You can send or receive chat mail messages to and from multiple persons on a single display. To use Chat Mail, you need to store chat members. You can easily store them by creating chat groups.

### Store Chat Members

You can store up to six chat members including the user (yourself).

- 1 Chat mail (FUNC)
- ▶ Chat member ▶ <Not recorded>**
- ▶ Enter a mail address.**

- To edit a stored member, select the member.
- When the mail address is "phone number@docomo.ne.jp", store the phone number only.
- You can enter up to 50 half-pitch characters.



#### Information

- If you edit the mail address of the stored member, the member's name and image are changed.

### Function Menu of the Chat Member List

Function menu	Operation/Explanation
Edit	You can edit the mail address. Go to step 1 on page 210.

Function menu	Operation/Explanation
Refer address	You can look up a phone number or mail address in the Phonebook, Sent Address, or Received Address to enter it. ▶ <b>Select an item.</b> <b>Phonebook</b> . . . . . Call up a Phonebook entry and select a phone number or mail address. <b>Sent address</b> . . . . . Select a phone number or mail address and press  (Select). <b>Received address</b> . . . . . Select a phone number or mail address and press  (Select).
Change member (Chat group)	You can store the members stored in a chat group as chat members. ▶ <b>Chat group ▶ Group list or Member list</b> <b>Group list</b> . . . . . You can select members by chat group. <b>Member list</b> . . . . . You can select members from all the members stored in chat groups. <ul style="list-style-type: none"> <li>• If you select "Group list", select a chat group. The members from the selected group are stored.</li> <li>• If you select "Member list", check the members you want to store and press  (Finish).</li> <li>• If you have already stored chat members, the confirmation display appears asking whether to replace all the chat members.</li> </ul>
Change member (Mail group)	You can store the mail addresses stored in Mail group as chat members. ▶ <b>Mail group ▶ Select a Mail group.</b> <ul style="list-style-type: none"> <li>• If you have already stored chat members, the confirmation display appears asking whether to replace all the chat members.</li> </ul>
Display setting	You can check the chat member's name, image, background color, and mail address. <ul style="list-style-type: none"> <li>• You can press  to switch members.</li> <li>• The mail address of the user (yourself) is not displayed.</li> </ul>



Function menu	Operation/Explanation
Delete (Delete this)	▶ Delete this ▶ YES
Delete (Delete all)	▶ Delete all ▶ YES

## Exchange Chat Mail Messages

### 1 Chat mail

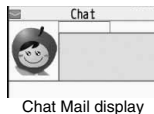

### 2 **Select** ▶ Enter characters.

- You can enter up to 250 full-pitch/500 half-pitch characters.

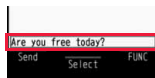

### 3 Press **Send**.

- The chat mail message is sent.
- The sent chat mail message is displayed at the top of the Chat Mail display.



### 4 The display for receiving chat mail appears and a chat mail message is received.

- The received chat mail message is displayed at the top of the Chat Mail display.
- Repeat step 2 through step 4 to send and receive chat mail messages.



### 5 **CLR** ▶ YES or NO

- YES** . . . . You can delete read and sent chat mail message from the "Chat" folder.
- NO** . . . . You do not delete read and sent chat mail message from the "Chat" folder.

Chat Mail ends.

- You can end Chat Mail also by pressing .
- When no sent and received chat mail messages are found, the confirmation display does not appear.

## ■ Chat Mail display

### 1 Image

The image you have stored in Chat Group is displayed.



### 2 Member name

The chat member's name store in the chat group is displayed. Also, the name is displayed with a specified background color.

- When the name is not stored in the chat group, up to eight half-pitch characters from the beginning of the mail address are displayed. When the mail address is stored in the Phonebook, up to four full-pitch/eight half-pitch characters from the beginning of the name are displayed.

### 3 Broadcast mark

Displayed when the chat mail message set with multiple addresses is received.

-  (blue): All addresses are stored in Chat Member.
-  (dark blue): Addresses that are not stored in Chat Member are found.

### 4 Sent/Received date and time

The date and time the chat mail message was sent/received are displayed. The time is displayed for the chat mail messages sent/received today and the date for the chat mail messages sent/received until yesterday.

### 5 Text

The text of chat mail message is displayed. The number of characters of the text to be displayed is up to 250 full-pitch/500 half-pitch characters.

If the text exceeds four lines,  is displayed and you can switch the pages by pressing



- You cannot switch the page of the text on the Chat Mail history.
- The text of the chat mail message successfully sent is displayed in black. The text of the chat mail message failed to be sent is displayed in gray.

### 6 Input box

Entered characters (characters to send) are displayed from the beginning by a factor of one line.

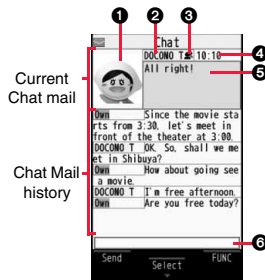

### Information

- The communication fee for when you send chat mail messages to multiple chat members is the same as for sending a chat mail message to one member. (However, the information volume for the added address increases the communication fee.)
- When "Receive option setting" is set to "ON", you cannot exchange chat mail messages.
- When the Inbox is full of unread or protected mail messages, you cannot exchange chat mail messages. Delete unnecessary mail messages or read unread mail messages, or release the protection and then operate.
- Attached files or pasted data are not displayed.
- Sent/Received chat mail messages are saved to the "Chat" folder.
- The subject of a sent chat mail message is "チャットメール (chat mail)" (half-pitch characters).
- Even when the chat mail text on the Chat Mail display contains the phone number, mail address, or URL, the Phone To/AV Phone To, Mail To, and Web To functions are not available. However, those functions will be available when Chat Mail is finished and chat mail message is brought up from the "Inbox" or "Outbox".
- During playing back a music file by MUSIC Player, a tone for the chat mail message does not sound.

### If You Receive Chat Mail during Standby

If you receive a chat mail message during standby, " appears on the desktop.

Press , highlight "", and press  (Select); then Chat Mail starts up.

### Information

- Messages are recognized as chat mail messages in the following cases:
  - When the sender's address or destination address is stored in Chat Member or in a chat group
  - When the subject contains "チャットメール (chat mail)" (all full-pitch or all half-pitch characters)
- Even when you receive a chat mail message from a member of a chat group other than Chat Member while Chat Mail is running, " appears.

### If you start Chat Mail from the desktop or Chat Group

If you start Chat Mail from a mail address or from a chat group that is not stored in Chat Member, the confirmation display appears asking whether to delete stored member and start Chat Mail.

Select "YES"; then the current chat members are deleted and the sender's mail address or chat group members are stored in Chat Member.



#### If you start Chat Mail from the desktop

The sender's mail address is stored in Chat Member. When the sender's mail address has been stored in a chat group, the members in that chat group are stored in Chat Member. However, the mail address selected as the destination is only the mail address of the sender.

#### If you start Chat Mail from Chat Group

The chat group members are stored in Chat Member. All members of the group are selected as the destination.

### Function Menu of the Chat Mail Display

Function menu	Operation/Explanation
Send	You can send the chat mail message.
Select receiver	From among chat members, you can select destination addresses to send the chat mail messages to. ▶ Put a check mark for destination addresses to send the messages to▶  (Finish)
Chat member	You can store chat members. (See page 210)
Broadcast address	You can check the destination addresses you have simultaneously sent a chat mail message to. <ul style="list-style-type: none"> <li>• When there are destination addresses that are not stored in Chat Member, the confirmation display appears asking whether to store them in Chat Member. If you store them in Chat Member, select "YES" and put a check mark for the destination addresses to be stored and press  (Finish).</li> </ul>
Reload	You can receive chat mail messages that you could not automatically receive. If you receive a new chat mail message, the Chat Mail display is updated.
View first line	You can display the latest chat mail message.
View last line	You can display the oldest chat mail message.

Function menu	Operation/Explanation
Delete read mails	You can delete all the received read chat mail messages and sent chat mail messages including secret mail and chat mail messages failed to send. ▶ YES

### Information

#### <Broadcast address>

- You can store up to six members (including yourself) in Chat Member.

## Chat Setting

- 1 ▶ Mail settings ▶ Chat setting  
▶ Do the following operations.

Item	Operation/Explanation
Sound setting	You can set a tone for when you send/receive a chat mail message on the Chat Mail display. ▶ Select a folder ▶ Select a tone. • The tone does not sound when a chat mail message comes in from a member not stored in Chat Member.
Chat image	You can set whether to display images on the Chat Mail display. ▶ ON or OFF
User setting	You can set the name and image of the user (yourself). ▶ Select the name field ▶ Enter a user name. • You can enter up to four full-pitch/eight half-pitch characters. • If you do not change the user name, go to the next step. ▶ Select the image field ▶ Select a folder ▶ Select an image.

## <Chat Group>

MENU 2 6

# Creating Chat Group

You can store the mail addresses you want to exchange chat mail per group.

By storing multiple members in a group, you can set them as chat members at a time.

You can store up to five mail addresses per group. You can create up to five groups.

- 1 ▶ Phonebook ▶ Phonebook settings ▶ Chat group ▶ Select a chat group to be stored.



Chat Group list

- When the selected chat group has any member,

"CHAT" appears at the lower left of the display.

If you press (CHAT), Chat group members are stored in Chat Member and Chat Mail starts. Go to step 2 on page 211.

- 2 Highlight <Not stored> and press

(Edit).

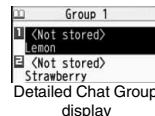

- If you select a stored mail address, the Chat Group Address Confirmation display appears.

- 3 Enter a mail address.





- You can enter up to 50 half-pitch characters.
- When the entered mail address is stored in the Phonebook, and the image is stored in the Phonebook, the image is also set.
- When the mail address is "phone number@docomo.ne.jp", store the phone number only.
- When you store multiple mail addresses, repeat step 2 and step 3.

## Function Menu of the Chat Group List

Function menu	Operation/Explanation
Activate chat	The members in the chat group are stored as chat members and Chat Mail starts. Go to step 2 on page 211.

Function menu	Operation/Explanation
<b>Edit group name</b>	▶ Enter a chat group name. • You can enter up to 10 full-pitch/20 half-pitch characters.
<b>Reset group name</b>	You can reset the name of the chat group to the default. ▶ YES

### Function Menu of the Detailed Chat Group Display/Chat Group Address Confirmation Display

Function menu	Operation/Explanation
<b>Edit</b>	You can edit the mail address. Go to step 3 on page 213. • You can edit also by pressing  (Edit).
<b>Refer address</b>	You can look up a phone number or mail address in the Phonebook, Sent Address, or Received Address to enter it. ▶ Select an item. <b>Phonebook</b> . . . . . Call up a Phonebook entry and select a phone number or mail address. <b>Sent address</b> . . . . . Select a phone number or mail address and press  (Select). <b>Received address</b> . . . . . Select a phone number or mail address and press  (Select).
<b>Change member</b>	You can store members from a Mail group in the chat group. ▶ Mail group ▶ Select a Mail group. • If you have already stored members in the chat group, the confirmation display appears asking whether to replace all the members.
<b>Member setting</b>	You can set the member's name and image. You can switch members by pressing  . ▶ Select the member name field ▶ Enter a member's name. • You can enter up to four full-pitch/eight half-pitch characters. • Not to change the member's name, go to the next step. ▶ Select the picture field ▶ Select a folder ▶ Select an image.

Function menu	Operation/Explanation
<b>Delete</b>	▶ YES
<b>Delete all</b>	▶ Enter your Terminal Security Code ▶ YES

### <Compose SMS>

## Composing SMS Messages to Send



You can compose and send SMS messages. You can save up to 1,000 sent SMS messages including i-mode mail messages to the Outbox.

- You can send and receive SMS messages to and from subscribers of overseas carriers other than DOCOMO. For the countries and overseas carriers available for the service, refer to the DOCOMO Global Service web page.
- You can move/copy the sent SMS messages to the UIM. (See page 370)

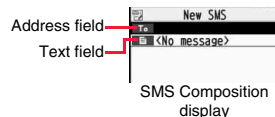
### 1 ▶ Compose SMS



### 2 Select the address field ▶ Select an item.

- Phonebook** . . . . . Call up a Phonebook entry and select a phone number.
- Sent address** . . . . . Select a phone number and press  (Select).
- Received address** . . . . . Select a phone number and press  (Select).
- Enter address** . . . . . Enter a phone number.

Only one address can be specified.

- You can enter up to 21 digits (including "+").
- When the address is that of overseas carriers other than DOCOMO, enter "+" (press and hold  for at least one second), "country code", and "destination mobile phone number" in that order. When the mobile phone number begins with "0", enter the phone number except for the "0". Also, you can enter "010", "country code", and "destination mobile phone number" in that order to send SMS messages. (When you reply to SMS messages received from overseas, enter "010".)

### 3 Select the text field ▶ Enter text.

- The number of characters you can enter differs depending on the "SMS input character".

## 4 Press (Send).

The animation display during transmission appears and mail is sent.

## 5 OK

### Information

- Depending on the radio wave conditions, the characters might not be sent successfully to the destination.
- When the number of sent mail messages exceeds the maximum number of storage, they will be overwritten starting from the oldest sent mail. However, protected sent mail cannot be overwritten.
- You cannot compose an SMS message when sent mail messages in the Outbox are saved to the maximum and all of them are protected, when 20 draft mail messages are saved, or when the Draft is full.  
Release the protection for sent mail messages, or send/delete draft mail messages, and then operate again.
- Even if "Activate" of "Caller ID notification" is set to "OFF", the caller ID is notified to the other party you send an SMS message to. If you attempt to send an SMS message to the phone number headed by "184"/"186", the confirmation display appears asking whether to delete prefix numbers and send the mail.
- If you set "SMS report request" to "ON", you cannot send SMS messages to the i-mode phone of the mova service.
- "+" is valid only at the beginning of the address.
- You cannot send the message to addresses that include any characters other than numbers, "x", "#", and "+".
- You cannot start a new line while editing the text.
- The special symbols (see page 444) are replaced by half-pitch spaces.
- Each space is counted as a character.
- You cannot reply to the SMS message whose sender is User unset/PublicPhone/Unavailable.
- In B Mode of 2in1, you cannot compose SMS messages.

### Function Menu of the SMS Composition Display

Function menu	Operation/Explanation
Send	You can send the SMS message. Go to step 5 on page 215.

Function menu	Operation/Explanation
Preview	Before sending, you can check the address and the text contents. <ul style="list-style-type: none"><li>Press  (Send) to send the SMS message.</li></ul>
Save	You can save the SMS message you are composing or editing to the Draft. <ul style="list-style-type: none"><li>You cannot save the message when the address field and text field are blank.</li></ul>
SMS report req.	See page 216.
SMS valid. per.	See page 216.
SMS input char.	See page 217.

### <Receive SMS>

## Receiving SMS Messages Automatically



You can save up to 2,500 received SMS messages including i-mode mail messages.

- You can move/copy the received SMS messages to the UIM. (See page 370)

## 1 When an SMS message arrives, " (white)" lights and the receiving message is displayed.

When receiving ends, the display shows the number of received SMS messages.

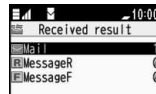

- You can display the Inbox list by selecting "Mail".
- If no keys are pressed for about 15 seconds, " " (see page 107) appears on the desktop and the former display returns. (The transit time varies depending on the setting for "Mail/Msg. ring time".)

Press , highlight " ", and press  (Select) to display the Inbox list.



Reception Result display

### Information

- When the number of unread or protected messages in the Inbox has reached the maximum, no new messages can be received and " (black)" is displayed. To receive SMS messages, delete mail in the Inbox or read unread mail or release protection until " (black)" clears, and then perform "Check new SMS".

## Display Newly Received SMS Messages

### 1 Reception Result display ▶ Mail

#### ▶ Select an SMS message to be displayed.

- Press and hold  for at least one second from the detailed SMS display to change the size of characters. (See "Mail" on page 111)



### Information

- Depending on the characters entered in the received SMS message, spaces might be displayed.
- While the sender's address (phone number) is highlighted in the displayed SMS message, you can press  (Select) to make a voice call or videophone call to the displayed number (the Phone To/AV Phone To function). Further, if the sender's phone number is stored in the Phonebook, the stored "name" is highlighted. In this case, you can dial the phone number in the same way.
- A Short Mail message is received as an SMS message on the FOMA phone. When the sender does not notify you of the phone number, the reason is displayed in the sender's field.

### <Check New SMS>

## Checking whether Center Holds SMS Messages

When SMS messages arrive at the SMS Center, they are automatically sent to your FOMA phone, but will be held at the SMS Center if your FOMA phone cannot receive messages such as when it is off or out of the service area.

You can receive the messages by "Check new SMS".

### 1 ▶ Check new SMS



### 2 Return

If the Center holds SMS messages, the FOMA phone automatically receives them.

### Information

- Some SMS messages are not delivered immediately after checking.

### Information

- When  (black) or  (black), etc. are displayed, you cannot receive any more SMS messages. Delete unnecessary mail, read unread mail, or release protection. (Read and unprotected messages are overwritten automatically from the oldest one.)
- You cannot use this function to receive i-mode mail or Messages R/F. Use "Check new message" to receive i-mode mail or Messages R/F.

### <SMS Settings>

## Setting SMS

### SMS Report Request

You can set whether to request an SMS report for when sending an SMS message.

The SMS report lets you know that your SMS message was delivered to the destination.

You can check received SMS reports in the "Inbox" folder.

### 1 ▶ SMS settings ▶ SMS report request ▶ ON or OFF

- When you operate from the Function menu of the SMS Composition display, the setting is effective only for the SMS message you are composing.

### SMS Validity Period

You can set the period that the SMS Center holds an SMS message sent but unsuccessfully delivered due to the out-of-service area, etc.

### 1 ▶ SMS settings ▶ SMS validity period ▶ Select a holding period.

- If you select "None", the stored SMS message is re-sent after a certain period of time and deleted from the SMS Center.
- When you operate from the Function menu of the SMS Composition display, the setting is effective only for the SMS message you are composing.

## SMS Input Character

You can set the characters you can enter into the text of SMS messages. You can set to enter only half-pitch alphanumeric characters and half-pitch symbols.

### 1 SMS settings ▶ SMS input character ▶ Select an item.

**Japanese (70char.)** . . . You can enter full-pitch and half-pitch characters. You cannot enter pictographs except “♥” and “☎” (see page 440). You can enter up to 70 characters for the text.

**English (160char.)** . . . You can enter only half-pitch alphanumeric characters and half-pitch symbols. You can enter up to 160 characters for the text.

- When you operate from the Function menu of the SMS Composition display, the setting is effective only for the SMS message you are composing.

## SMS Center Selection

※Normally, you do not need to change this setting.

You can set the address and “Type of number” for the SMS Center. This setting is for getting any service other than SMS Service you currently use.

### 1 SMS settings ▶ SMS center selection

▶ User setting ▶ Enter an address

▶ International or Unknown

- You can enter up to 20 half-pitch characters for the address. However, if “X” or “#” is included, you cannot set it for “International”.
- You can reset User Setting to “DoCoMo” by Reset ▶ Enter your Terminal Security Code ▶ YES.

<Web Mail>

## Using Web Mail

You can send mail messages or browse received mail messages on the i-mode site.

- You can use only in B Mode or Dual Mode of 2in1.
- For details on Web mail, refer to “Mobile Phone User’s Guide [2in1]”.

### 1 Web mail

▶ Operate following the instructions on the display.

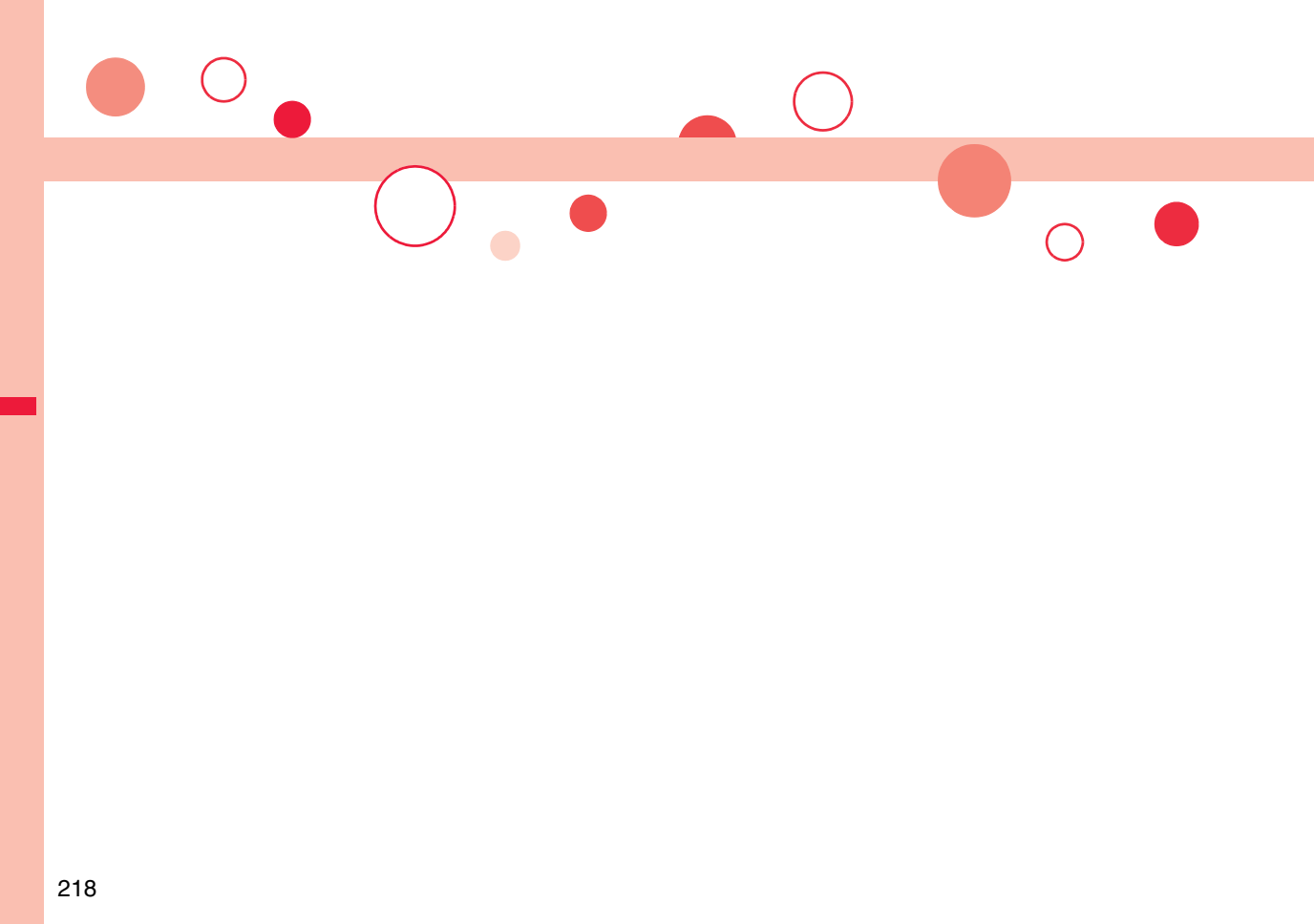



<b>What is i-appli?</b> .....	220
<b>Downloading i-appli from Sites</b> .....	<i-appli Download> 220
<b>Starting i-appli</b> .....	<i-appli Run> 221
<b>Setting i-appli</b> .....	< i-appli Settings> 234
<b>Starting i-appli Automatically</b> .....	234
<b>Operating i-appli Stand-by Display</b> .....	<i-appli Stand-by Display> 235
<b>Displaying i-appli Data Files on the microSD Card</b> .....	< i-appli(microSD)> 236

## What is i-αpli?

By downloading i-αpli programs from sites, you can use the FOMA phone more conveniently. Some i-αpli programs enable you to directly store data in the Phonebook or Schedule and some are linked to Data Box to save/obtain images.

Also, as the large capacity mega i-αpli is supported, you can enjoy playing high-resolution 3D games and full-length role playing game.

● For details on i-αpli, refer to the "Mobile Phone User's Guide [i-mode] FOMA version".

### <i-αpli Download>

## Downloading i-αpli from Sites

You can download software programs from sites to the FOMA phone. You can save up to 100 files, however, the number of files you can save decreases depending on the data volume because the memory space is shared with other data files. (See page 474)

### 1 Bring up an i-αpli downloadable site

- ▶ Select a software program.

### 2 Select "OK" when downloading ends.

- See page 163 when i-αpli programs are stored to the maximum.
- When downloading ends, the display for Software Setting (Network Set, Stand-by Set, or Program Guide Key) might appear. These settings can be done also from the Software list.

### 3 YES or NO

YES . . . . Starts i-αpli.

NO . . . . Returns to the site display.

### When downloading is suspended

When you press (CLR) or ( ) to suspend downloading an i-αpli program of 100 Kbytes or more, or when downloading is suspended by the radio wave conditions, the confirmation display appears asking whether to resume downloading. Select "YES" to resume downloading the remaining part. Select "NO" to show the confirmation display asking whether to save the file downloaded halfway. Select "YES" to partially save the file.

You can re-download the rest of the partially saved i-αpli program from the Software list.

### When you downloaded mail-linked i-αpli

An i-αpli mail folder is created automatically each in the Inbox/Outbox Folder list, and the title of the downloaded mail-linked i-αpli becomes the name of the folder.

- You can save up to five mail-linked i-αpli programs.
- You cannot download the software program if the mail-linked i-αpli using the same folder is already in the Software list.
- You cannot download mail-linked i-αpli while Mail Security is set.
- You cannot download mail-linked i-αpli if the Inbox/Outbox Folder list contains five i-αpli mail folders.
- When re-downloading mail-linked i-αpli whose folder only remains, the confirmation display appears asking whether to use the existing i-αpli mail folder. If you select "YES", the existing folder is used. If you select "NO" because you do not use it, the confirmation display appears asking whether to delete an existing folder and create a new one. You cannot download mail-linked i-αpli without creating a new folder.

### Information

- You can download pre-installed i-αpli programs from the "P-SQUARE" site (Japanese only).  
☰ Menu→メニューリスト (Menu List)  
→ケータイ電話メーカー (Mobile Phone Maker)→P-SQUARE



QR code for  
accessing the site

- Downloading is not available from some accessed sites.

## Information

- Some i-oppli programs can automatically connect to the i-mode Center after they are downloaded. However, to use this service, you need to set it in advance in "Software setting (Network set)".
- "i" appears at the top of the display while software information or a software program is being downloaded from SSL pages.
- At downloading, the confirmation display might appear asking whether to send the "serial number of your mobile phone/UIM". Select "YES" to start downloading. In this case, the "serial number of your mobile phone/UIM" is sent to the IP (Information Provider) over the Internet, so could be deciphered by third parties. However, your phone number, address, age, and gender are not notified to the IP (Information Provider) or others by this operation.
- If you attempt to re-download the software program that was downloaded using a different UIM, the confirmation display appears asking whether to overwrite the software program. With the Osaifu-Keitai compatible i-oppli, the confirmation display appears telling that the data on the IC card is to be deleted. Select "YES" to start downloading. When downloading ends, the software program that was downloaded using a different UIM and the data on the IC card are deleted.
- You cannot download some software programs while the IC card function is working or IC Card Lock is activated.
- Some software programs that start immediately after downloading cannot be saved.
- Depending on the data volume on the IC card, you might not be able to download Osaifu-Keitai compatible i-oppli even if there is still available space for software storage. Delete the displayed software programs following the confirmation display, and then download it again. (Some software programs might not be targeted for deletion, depending on the software type to be downloaded.) Depending on the software program, you need to start it and delete the files on the IC card before deleting the software program itself.
- You can save up to 1 Mbyte per i-oppli program.
- "i-oppli mail" is the mail sent and saved by mail-linked i-oppli and mail received as mail-linked i-oppli. i-oppli mail is automatically saved to the i-oppli mail folder.
- The 3D polygonal<sup>※</sup> engine enables cubic images to be displayed in i-oppli.  
<sup>※</sup>By combining polygons, a deep, cubic image is displayed.

## Display Software Info













You can display software information when downloading i-oppli.

- 1  **i-oppli**  **oppli settings**  **Disp. software info**  
 **Display or Not display**

<i-oppli Run>





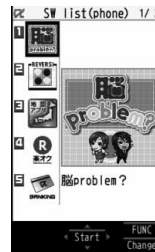

## Starting i-oppli

- 1  **(for at least one second)**  
 **Select a software program to be started.**

-  : Osaifu-Keitai compatible i-oppli
-  : Management information i-oppli
-  : microSD card compatible i-oppli
-  : Vertical full display compatible i-oppli
-  : i-oppli DX
-  : Mail-linked i-oppli
-  : Partially saved i-oppli
-  : Set for Auto Start
-  : Set for the i-oppli Stand-by display
-  : Set for both Auto Start and the i-oppli Stand-by display
-  : Can set for the i-oppli Stand-by display
-  : Downloaded from an SSL page
-  : Downloaded or upgraded by using a different UIM





Software list

- You can display the Software list on the microSD card by  ► i-ϕpli ►  ϕpli(microSD) ► SW list(microSD).
- Each time you press  (Change) from the Software list in the FOMA phone, the display format changes.
- When you start an i-ϕpli DX program or while it is running, the confirmation display might appear asking whether to permit the i-ϕpli DX program to use the FOMA phone's information and functions.
- When you select a partially saved i-ϕpli program, you can download the remaining part of it.
- " DL" or " DLK" is displayed while an i-ϕpli program is running.
- To end i-ϕpli, press and hold  (CLR) for at least one second or press ; then select "YES".
- The software program you started last time comes at the top of the list. You cannot manually change the order of software programs.
- See page 163 when you select "Search by i-mode".

### Information

- When a software program can be started from another program, the confirmation display appears. When a software program to be started is not specified, select a software program.
- To start up i-ϕpli DX, set the data and time by "Set time" beforehand.
- When a software program is running, melodies are played back at the volume set for "Phone" or "Ring volume". However, melodies are not played back during a call.
- You may need to set the communication setting while a software program is running.
- When communicating frequency is extremely high in a certain period of time while an i-ϕpli program is running, the confirmation display appears asking whether to continue communicating.
- With some software programs, you can use the Web To function and the Phone To/ AV Phone To function from i-ϕpli. However, you cannot use them while the software program is running as the i-ϕpli Stand-by display.
- If you start the camera from i-ϕpli, the shot images are not saved with ordinary images, but are saved as part of i-ϕpli for its usage.
- If you start the camera from i-ϕpli, you can specify the image size or image quality for some i-ϕpli programs.
- You can scan QR codes and JAN codes from i-ϕpli using the camera. The scanned data is saved and used by the software program.

### Information

- Images<sup>\*\*</sup> that are used by i-ϕpli and data you have entered might be sent over the Internet to the server automatically.
  - <sup>\*\*</sup>i-ϕpli uses the following types of images:
    - Images shot by the camera after it is started from a camera-linked application program
    - Images obtained by the infrared data exchange function of i-ϕpli
    - Images downloaded from sites or Internet web pages
    - Images obtained from Data Box by i-ϕpli
- i-ϕpli mail running under mail-linked i-ϕpli might not be displayed correctly.
- Some i-ϕpli programs save the various information used on the i-ϕpli programs when you end them. However, the information might not be saved if the low battery alarm sounds or the battery pack is removed while the i-ϕpli program is running. If the battery level indicates "", either press  or end the i-ϕpli program in accordance with the operation of each software program.
- You can save the data files of some software programs to the microSD card, but you might not be able to use them for another model. You can check "ϕpli(microSD)" for the software programs that use the microSD card.
- Some IPs (Information Providers) may access the software program stored in your mobile phone and have it directly halted, depending on the software program. In that case, you will not be able to start or upgrade the software program, or use it for the Stand-by display. You can delete it or display the software information. To resume running the software program, you need to receive the communication to cancel the software halting state. Contact the IP (Information Provider) to inquire about that.
- Some IPs (Information Providers) might send data to the software program stored in your mobile phone depending on the software program.
- When the IP (Information Provider) requests to halt or re-open the software program or sends data to it, the mobile phone communicates and "" is displayed. In this case, you are not charged a communication fee.
- To creators of i-ϕpli  
If you encounter an error while creating a software program, the Trace Information display might help identify the problem.  
For how to check the trace information, see "Trace Information" on page 223.

## Trace Information

You can check the details when a software program malfunctions.

### 1 i- **Trace info**

- When the memory space for Trace Info becomes full, the information is overwritten from the oldest one.
- You can operate "Copy info" and "Delete info" from the Function menu.







## Security Error History

















You can check the details when an i- program ends because of a security error.

### 1 i- **Security error history**

- You can operate "Copy info" and "Delete info" from the Function menu.
- You can display the security error history also by selecting "" on the desktop.

## Function Menu of the Software List

Function menu	Operation/Explanation
<b>Set  To</b>	You can set whether to permit the i-  program to start from a link on site or mail message. You can set also for when you place the FOMA phone over an IC card compatible scanning device. You can set this for each software program. ▶ <b>Put a check mark for items to be set</b> ▶  (Finish) • Some items might not be set depending on the software program.
<b>Auto start time</b>	See page 234.
<b>Software setting (Stand-by set)</b>	See page 235.
<b>Software setting (Network set)</b>	You can set whether to communicate while an i-  program is running. ▶ <b>Network set</b> ▶ <b>ON, OFF or Check every start</b> ▶  (Finish) • If you select "Check every start", the confirmation display appears each time you start the i-  program.

Function menu	Operation/Explanation
<b>Software setting (Stand-by net)</b>	See page 236.
<b>Software setting (Icon info)</b>	You can set whether to permit the i-  program to use information of icons indicating i-mode mail, SMS messages, Messages R/F, battery level, Manner Mode, and within/out-of service area. ▶ <b>Icon info</b> ▶ <b>ON or OFF</b> ▶  (Finish)
<b>Software setting (Change mld./img.)</b>	You can set whether to permit the i-  program to change the setting for the ring tones, Stand-by display, etc. This function is available only for i-  DX programs. ▶ <b>Change mld./img.</b> ▶ <b>ON, OFF or Check every change</b> ▶  (Finish) • If you select "Check every change", the confirmation display appears each time the i-  program tries to change the setting for the ring tones, Stand-by display, etc.
<b>Software setting (See P. book/hist.)</b>	You can set whether to permit the i-  program to refer to the Phonebook, Redial, and Received Calls. This function is available only for i-  DX programs. ▶ <b>See P. book/hist.</b> ▶ <b>ON or OFF</b> ▶  (Finish)
<b>Software setting (View ToruCa)</b>	You can set whether to permit the i-  program to refer to ToruCa files. This function is available only for i-  DX programs. ▶ <b>View ToruCa</b> ▶ <b>ON or OFF</b> ▶  (Finish)
<b>Software setting (Program guide key)</b>	You can set the software program for the Program Guide i-  that starts up from 1Seg. You can set this only for the i-  DX program that links to 1Seg. ▶ <b>Program guide key</b> ▶ <b>ON or OFF</b> ▶  (Finish)
<b>Software info</b>	You can display the software name, version, and others of the i-  program.
<b>Upgrade</b>	▶ <b>YES</b>
<b>Add desktop icon</b>	See page 109.
<b>Delete (Delete this)</b>	▶ <b>Delete this</b> ▶ <b>YES</b>

Function menu	Operation/Explanation
Delete (Delete selected)	▶ Delete selected ▶ Put a check mark for software programs to be deleted ▶  (Finish) ▶ YES
Delete (Delete all)	▶ Delete all ▶ Enter your Terminal Security Code ▶ YES
Move to microSD	See page 311.
Move to phone	See page 311.
Power saver	You can set whether to validate Power Saver Mode for each i-opppli program for when "Power saver" is set to "ON". ▶ ON or OFF

### Information

#### <Software setting (Icon info)>

- When you set "Software setting (Icon info)" to "ON" for the i-opppli Stand-by display, the icon information for unread mail/message, battery level, Manner Mode, radio wave strength and out-of-service area can be sent to the IP (Information Provider) over the Internet in the same way as the serial number of your mobile phone/UIIM, and can be deciphered by third parties.
- When the software program needs "Software setting (Icon info)", the software program might not run if "OFF" is selected.

#### <Upgrade>

- Depending on the software program, you can upgrade it at start.
- At upgrading, the confirmation display might appear asking whether to send the "serial number of your mobile phone/UIIM". Select "YES" to start upgrading. In this case, the "serial number of your mobile phone/UIIM" is sent to the IP (Information Provider) over the Internet, so could be deciphered by third parties. However, your phone number, address, age, and gender are not notified to the IP (Information Provider) or others by this operation.
- You cannot upgrade the mail-linked i-opppli in the following cases:
  - While details of the corresponding i-opppli mail folder are displayed
  - While Mail Security is set
  - When Mail Security is set for the corresponding i-opppli mail folder

### When you delete mail-linked i-opppli

The confirmation display appears asking whether to delete the i-opppli mail folder as well. If you do not delete it, you can check the text of mail from the Outbox/Inbox list.

YES. . . . . Deletes both the software program and the i-opppli mail folder.

NO. . . . . Deletes the software program only and the i-opppli mail folder is left.

Cancel. . . . . Does not delete both the software program and i-opppli mail folder; the former display returns.

- You can delete neither the i-opppli program nor the i-opppli mail folder even if you select "YES", in the following cases:

- While Mail Security is set
- While the folder is set with security
- While displaying details of the folder
- When the folder contains protected mail

### When you delete an i-opppli program whose files are on the microSD card

The confirmation display appears asking whether to delete files on the microSD card as well.

YES. . . . . Deletes both the software program and files on the microSD card. Press "YES" again on the confirmation display. You need to enter your Terminal Security Code to execute "Delete" or "Delete selected".

NO. . . . . Deletes the software program only and the files are left.

Cancel. . . . . Does not delete both the software program and files on the microSD card, and the former display returns.

### When you delete Osaifu-Keitai compatible i-opppli

The confirmation display appears telling that the files on the IC card will be deleted.

- You might not be able to delete the Osaifu-Keitai compatible i-opppli unless you delete the files on the IC card after starting the Osaifu-Keitai compatible i-opppli.
- You might not be able to delete the Osaifu-Keitai compatible i-opppli while the IC card function is working or IC Card Lock is set.

## Pre-installed i-appli Programs

### The following i-appli programs are pre-installed:

- You can delete the pre-installed i-appli programs except for “Gガイド番組表リモコン (G Guide Program List Remote-controller)”. You can re-download them from the “P-SQUARE” site (see page 164). When you use a UIM other than the one used for downloading, the UIM security function (see page 37) is set for them.
- Deadlines for re-download services
  - ・ “脳problem? (No Problem?)”: the end of July, 2012
  - ・ “リバーシ (REVERSI)”: the end of July, 2012
- The re-download service might be halted or closed without notice even in the service period.

### 脳problem? (No Problem?)

This is a new brain game which consists of enjoyable mini games specific to five brain-training fields. Get your carrier progress by getting high scores in the challenge mode.



© Panasonic Mobile Communications Co., Ltd.

## 1 Software List ▶ 脳problem? (No Problem?)

- When “ ×” or another appears at the lower left of the display, press to adjust the sound volume.

## 2 Press a few times ▶ Enter a name ▶ YES ▶ Select a secretary ▶

- You can enter the name of up to 6 full-pitch/12 half-pitch characters.
- You can display the secretary's profile when you press ( 紹介 ) from the secretary selection display.
- When personal data files are already stored, select a desired personal data file. You can store a new personal data file by selecting “新規データ作成 (Create new data)”. You can display the explanation for the i-appli program by selecting “説明 (Explanation)”.
- When a suspended data file remains, a confirmation display appears asking whether to resume the game. Suspended data files are stored for each player.

## 3 Select a menu item.

- トレーニングモード (Training mode) . . . Select a game and play it.
- チャレンジモード (Challenge mode) . . . You can play the games of five fields one by one. According to the score you get, you are ranked up, or the number of games you can play or the number of secretaries increases.
- 成績確認 (Confirm score) . . . . . You can confirm the game score.
- 秘書変更 (Change secretary) . . . . . You can change secretaries.
- 名前変更 (Change name) . . . . . You can change the name of personal data.
- データ削除 (Delete data) . . . . . You can delete the personal data.

### リバーシ (REVERSI)

Two black and two white tiles are located diagonally in the center of an eight by eight grid board.

When you surround the opponent's tile with your tiles, it switches over to your tile color.

Tiles can be surrounded horizontally, vertically, and diagonally. Black and white take turns placing tiles on the board, and the winner is the player who could reverse all of the opponent's tiles or could get more tiles at the end of the game.

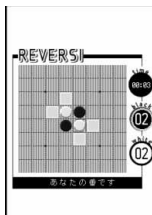

© Panasonic Mobile Communications Co., Ltd.

## 1 Software List ▶ リバーシ (REVERSI)

- When “ ×” or another appears at the lower left of the display, press to adjust the sound volume.

## 2 Select a menu item.

- ゲーム開始 (Start game) . . . Start the game. Go to step 3.
- レコード (Record) . . . . . Check your ranking and records.
- オプション (Options) . . . . . Change BGM or turn ON/OFF the ヒント (hint) function. When the ヒント (hint) function is ON, squares you can put a tile appear.
- ヘルプ (Help) . . . . . Displays the explanations about the rules, operations, records, and options.
- When the confirmation display appears asking whether to restart the suspended game at the time of a game start, select “YES” to restart the suspended game.

### 3 Select an item.

**難易度 (Difficulty)** . . . Set a level of the game from among “初級 (Beginner)”, “中級 (Intermediate)”, and “上級 (Advanced)”.  
(The background color differs depending on the difficulty.)

**順番 (Order)** . . . . . Select “黒番 (先手) [Black (first move)]”, or “白番 (後手) [White (passive move)]”.

### 地図アプリ (Map Application)

“地図アプリ (Map Application)” is the i-oppli program that enables you to use Open i-area for checking your current location, to see the map of the specified location, or to check the routes to your destination.

You can easily get transfer information by voice input.

- You are separately charged a packet communication fee. You are advised to subscribe to Pake-Houdai/Pake-Houdai Full for using this software program.
- If you delete this software program and then when you want to resume it, download it from “i エリアー周辺情報 - (i-area -Area Information-)”.
- This software program is not available when the mode of 2in1 is set to B Mode.
- Note that we are not held responsible for the accuracy and promptness of the map and route information.
- While driving, ensure that a person other than the driver operates this software program.

### ■ Standard and optional services

The standard and optional services are available with this software program.

Standard service: Provided by DOCOMO (charge free).

Optional service: Provided by ZENRIN DataCom (charged).

You can use the optional services charge free except traffic information for up to 90 days from when you have started this software program for the first time. To use the optional services from 91 days on, you need to register yourself as a member of “ゼンリン 地図+ナビ (ZENRIN/map+navi)” (charged) provided by ZENRIN DataCom.

Even when you register yourself as a member while you are using this software program, you do not need to re-download it. You can use this software program as it is.

Menu	Descriptions	From 91 days on
地図 Map	<ul style="list-style-type: none"> <li>● By using Open i-area, you can read the map of the place you are currently in or specified by entering a keyword, address, or phone number.</li> <li>● By speaking an address to input, you can easily read the map.</li> </ul>	Free
	<ul style="list-style-type: none"> <li>● You can check the map of the place stored in this software program, on the server, or retrieved by the previous search.</li> <li>● After you store it on the server, the stored point can be shared with your personal computer as well.</li> </ul>	Charged
周辺検索 Local Search	<ul style="list-style-type: none"> <li>● You can check information of shops, facilities, or iD member shops in the area you are currently in or you specify, and can obtain coupons from gourmet information.</li> <li>● You can check nearby empty parking lots.</li> <li>● By voice input, you can easily check area information.</li> </ul>	Free
ルート案内 Route	<ul style="list-style-type: none"> <li>● You can search for the route to the destination via a comprehensive means of transportation including vehicle, foot, and car.</li> <li>● You can easily search for a route to your home you have stored.</li> </ul>	Charged
乗換案内 Transfer	<ul style="list-style-type: none"> <li>● You can check the train transfer information and timetables.</li> <li>● You can check the map for a train route and set an alarm to sound before your departure.</li> <li>● By voice input, you can easily get transfer information.</li> </ul>	Charged
エクストラ Extra	<ul style="list-style-type: none"> <li>● In addition to the ordinary map, you can change the mode to show the various types of maps such as the 3D map and the map that accentuates train routes.</li> <li>● On the map, you can color the places where you measured in the past using Open i-area, by the unit of city, ward, town, village, or prefecture.</li> </ul>	Free
	<ul style="list-style-type: none"> <li>● To the server, you can back up the area data that you measured in the past using Open i-area.</li> </ul>	Charged



Menu	Descriptions	From 91 days on
災害用メニュー Emergency	<ul style="list-style-type: none"> <li>You can search for facilities which are useful in a time of disaster.</li> <li>This is a disaster-time use i-appli program that links with the map application but does not require communication.</li> </ul>	Charged
設定／ヘルプ Setting/ Help	<ul style="list-style-type: none"> <li>You can set how to show the map and route, and check how to use them.</li> </ul>	Free

#### ■“地図アプリ (Map Application)” TOP menu display and its operation

The respective menus are displayed on the TOP display.

When you close the menu, the map retrieved by the last search appears.

- The displays are for reference, so the actual ones might differ.
- At the first start-up, the usage rules and caution items on use are displayed.



TOP display

#### ◆When 90 days passes without registering yourself as a member

At the first start-up on or after 91 days, the message telling that the functions you can use are limited, and the message that refers to the member registration site appear.

The same messages appear when you select an optional service menu.

- To register yourself as a member, access “ゼンリン 地図 + ナビ (ZENRIN/map+navi)” via this software program.

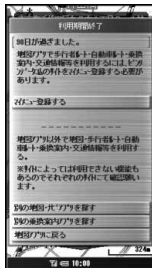

#### ■Map display and its operation



Map View display





© 2008 ZENRIN DataCom

#### ◆Key operation when the map is shown

Key operation	Action
[メニュー (Menu)]	Can show the menu.
[ ]	Can show the quick access menu.
[拡大] (Enlarge/Reduce)	Can show the scale bar. To display a large area, press [ ], and to display the details, press [ ]. Press [閉じる] (close) to fix the reduced scale, and then to clear the bar.
[ ]	Can move the map up, down, left, and right.
[CLR]	Can close the menu or return to the point retrieved by the first search.
[X]	Can turn the map counterclockwise.
[O]	Can turn the map northward.
[#]	Can turn the map clockwise.

#### ◆Key operation when the quick access menu is shown

Key operation	Action
[ ] (周辺を調べる (Check area information))	Can check area information of the place displayed on the map.
[ ] (ココへのルート (Route to this place))	Can set the start point and search for a route to the center of the map.

Key operation	Action
 [ココを 送信 (Send this place by )]	Can send the URL for the displayed map by i-mode mail.
 [ココを登録 (Store this place)]	Can store the location information on the center of the map in this software program, or on the server. When you store it on the server, the stored point can be shared with your personal computer as well.
 [地図へ (To map)]	Can close the quick access menu.
 [3D パノラマ (3D Panorama)]	Can show the points you can browse their panoramic images. Select a point to show the panoramic image.
 [ビル テナント (Building Tenant)]	Can show the buildings around and can click to check the tenants in the buildings if any.

#### ■ The Search Result display for area information and its operation

- The display is for reference, so the actual one might differ.
- The display and operation are for when you show the search result on the map, not for when you select it from the list.

#### ◆ The Search Result display for area information











© 2008 ZENRIN DataCom

#### ◆ Key operation when the Search Result display for area information is shown

※ When the cursor is not placed over the shop, etc. retrieved by the search, the quick menu appears.

Key operation	Action
	Can confirm detailed information about search results.

Key operation	Action
	Can move the map up, down, left, and right.
	Can re-search the center area of the displayed map.
	Can show the previous search results.
	Can show the next search results.
 [メニュー (Menu)]	Can show the menu.
 [拡大縮小 (Enlarge/Reduce)]	Can show the scale bar. To display a large area, press  , and to display the details, press  . Press  [閉じる (close)] to fix the reduced scale, and then to clear the bar.

### Searching for Routes to Destination

You can set a start point and destination, and search for a route. The routes you can go through on foot, by public transportation, or by car are displayed.

#### 1 TOP menu ▶ ルート案内 Route

##### ▶ ルート検索 (Search for a route)

#### 2 出発地 (Start point) ▶ Select a setting method.

- このあたり (Around here) . . . . . Set a start point measuring the approximate location by Open i-area.
- フリーワード検索 (Keyword search) . . . . . Set a start point searching by keywords.
- 地図上で指定 (Specify on map) . . . . . Set a start point on the map.
- TEL / 〒検索 (TEL/ZIP code search) . . . . . Set a start point searching by a phone number or zip code.
- 住所一覧から (From address list) . . . . . Set a start point selecting an address.
- ジャンルから (From genre) . . . . . Set a start point selecting a genre.
- 履歴から (From record) . . . . . Set a start point on the map previously displayed.
- 登録地点から (From stored point) . . . . . Set a start point from the location information stored in this software program or on the server.
- 自宅 (Home) . . . . . Set a start point from the location information of your home.
- 出発地の確認 (Confirm start point) . . . . . Confirm information about the start point.

### 3 目的地 (Destination) ▶ Select a setting method.

フリーワード検索 (Keyword search) ... Set a destination searching by keywords.

地図上で指定 (Specify on map) ... Set a destination on the map.

TEL/〒検索 (TEL/ZIP code search) ... Set a destination searching by a phone number or zip code.

住所一覧から (From address list) ... Set a destination selecting an address.

ジャンルから (From genre) ... Set a destination selecting a genre.

履歴から (From record) ... Set a destination on the map previously displayed.

登録地点から (From stored point) ... Set a destination from the location information stored in this software program or on the server.

自宅 (Home) ... Set a destination from the location information of your home.

目的地の確認 (Confirm destination) ... Confirm information about the destination.

### 4 時間指定 (Specify time) ▶ Select an item.

現時刻で指定 (Specify by current time)

... Search for a route by the current time.

出発時刻指定 (Specify start time)

... Search for a route specifying the start time.

到着時刻指定 (Specify arrival time)

... Search for a route specifying the arrival time.

終電を利用 (Use last train)

... Search for a route by the last train of the day.

### 5 条件設定 (Set conditions) ▶ Select a conditions

▶ 上記で設定 (Fix as specified above)

乗換条件 (Transfer conditions)

... Select a transfer priority criterion from “早い (Fast)”, “安い (Cheap)”, and “楽々 (Easy)”.

徒歩ルート (Foot route)

... Select a route priority criterion from “おまかせ (Free)”, “屋根多い (Many roofs)”, and “階段少ない (Less stairs)”.

◀ 特急利用 (Use special express)

... Select whether to use special expresses for even when the total distance is less than 100 km.

通常利用車種 (Ordinary type of vehicles)

... Select a type of vehicle.

### 6 ルートを検索 (Search for a route)

You can search for a route by “ で検索 (Search by )” that searches for all types of routes, or “ のみで検索 (Search by only )” that searches for routes only by car. Up to six routes are displayed as search results. When the routes using different transportation are found, the characteristics of the routes are displayed by the icons shown below:

早 (Fast): Required time is less.

安 (Cheap): Fare is cheap.

楽 (Easy): Transfer is less.

オススメ (Recommendable): Route provided with three conditions, “早 (Fast)”, “安 (Cheap)”, and “楽 (Easy)”.

有料 (Charged): Route by car using toll roads

一般 (Ordinary): Route by car using ordinary roads

● To store the route, select “ルートを登録 (Store route)”.

### 7 ルートを選択 (Select a route) ▶ ルート確認 (Confirm route)

#### Using 音声入力 (Voice Input)

By voice input, you can easily check area information, get transfer information, or read the map from the Voice Input menu.

<Example> When using Voice Input of 周辺検索 Local Search

#### 1 TOP menu ▶ 周辺検索 Local Search

##### ▶ 音声入力 (Voice Input)

The explanatory display for voice input appears.

## 2 ▶ 音声入力開始 (Start voice input) ▶ Speak about the area information to search for.

After the Voice Input display appears, speak in Japanese about the area information to search for.

Example: "Konoheno-n Konbini" (nearby convenience store)

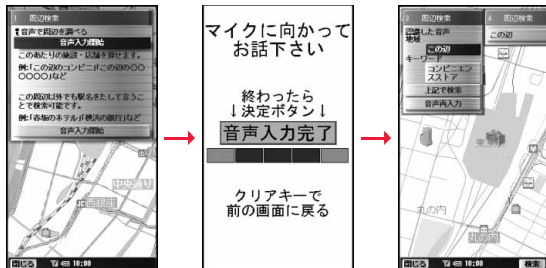

The confirmation display appears after your voice is recognized.  
When the recognition result is wrong, select "音声再入力 (Re-input voice)".

## Using Settings/Help

### 1 TOP menu ▶ 設定 / ヘルプ Setting/Help ▶ Select an item.

Item	Action
各種設定 (Settings)	You can perform the application basic setting, route setting, home setting or nearby station setting, erase all records, and initialize the application setting.
ヘルプ・規約 (Help/Rules)	You can get explanation about how to use, FAQ, and usage rules.
会員情報確認 (Confirm member information)	You can check whether you are registered as a member of "ゼンリン 地図+ナビ (ZENRIN/map+navi)".
PC確認方法 (For check on PC)	You can display the URL, log-in ID, and password to browse the map application site for personal computers.

## 楽オク出品アプリ2 (Rakuoku Exhibition Application 2)

"楽オク出品アプリ2 (Rakuoku Exhibition Application 2)" enables you to easily exhibit your goods on Rakuoku whenever you want wherever you are. Even if you are a beginner, an instruction guides you through exhibition procedures, so you can use it easily. The convenient functions such as shooting/editing photos and saving records are available so that you can exhibit your goods in a shorter time than you do on sites.

- You need to agree with "利用規約 (Usage rules)" for the first time.
- You are separately charged a packet communication fee.
- For details on Rakuoku, refer to "Mobile Phone User's Guide [i-mode] FOMA version".
- To exhibit on Rakuoku, you need to register with the Rakuten membership and exhibitor membership.
- For the information about Rakuoku, refer to i-mode site. i-mode site: Menu→オークション (Auction)



※ The display is for reference.  
The actual one may differ.



QR code for accessing the site

## i アプリバンキング (i-oppli Banking)

This is an i-oppli program that enables you to conveniently use mobile banking. Mobile banking enables you to use your FOMA phone to check the account balance, check the deposits/withdrawals, and transfer/shift money whenever you want and wherever you are. By entering your specified password at the start of this application program, you can use the mobile banking services for up to two banks.

- To use mobile banking, you need to have the bank account and subscribe to the mobile banking service of each bank.
- You are separately charged a packet communication fee.
- For details on i-oppli Banking, refer to "Mobile Phone User's Guide [i-mode] FOMA version".
- For the information about i-oppli Banking, refer to i-mode site.  
i-mode site: ☎ Menu→メニューリスト (Menu List)  
→モバイルバンキング (Mobile Banking)  
→i アプリバンキング (i-oppli Banking)



※ The display is for reference.  
The actual one may differ.



QR code for  
accessing the site

## Gガイド番組表リモコン (G Guide Program List Remote-controller)

This is a convenient i-oppli program that bundles the TV program list and AV remote-controller function and the monthly charge is free.

Anytime and anywhere you are, you can easily obtain the terrestrial digital, terrestrial analog or BS digital TV program information for the desired time zone. You can know about titles, contents, and start/end times of TV programs. Further, you can start a 1Seg program from the program list and vice versa.

If there is any program you want to watch, you can set timer recordings of the program on a DVD recorder, etc. over the Internet. (You need to have a DVD recorder, etc. that supports the remote timer recording function. And you need to perform initial settings of this application program.) Further, you can search for the program information by keywords such as program genres or celebrities you like, or pickup keywords on the top of the display. You can also remote-control a TV, video recorder, and DVD player. (Some models are not supported.)

- See "Using Infrared Remote-controller Function" on page 321 for details on the infrared remote-controller.
- You need to make the initial settings and to agree with the usage rules for the first time.
- You are separately charged a packet communication fee.
- To use this application program overseas, set the FOMA phone's clock to Japan time.
- For details, refer to "Mobile Phone User's Guide [i-mode] FOMA version".
- You cannot delete "Gガイド番組表リモコン (G Guide Program List Remote-controller)".
- This software program is not available when the mode of 2in1 is set to B Mode.

### About program booking function

You can select and book a program you want to watch from the program list of this application program.

#### How to book a program

1. Software list▶Gガイド番組表リモコン (G Guide Program List Remote-controller)
  - ▶ Highlight a program to be booked and press **戻る** (メニュー)
  - ▶ 視聴予約 (Book program)▶ 予約実行 (Execute booking)
  - ▶ Operate following the instructions on the display.





※ The display is for reference.  
The actual one differs.  
Local programs according  
to your region appear on  
your display.

## About timer recording function

You can select a program you want to record and set a timer recording from the program list of this application program.

### How to set a timer recording



1. Software list▶Gガイド番組表リモコン (G Guide Program List Remote-controller)
  - ▶ Highlight a program to be set for a timer recording and press  ()
  - ▶ #ワンセグ録画予約 (1Seg timer recording)▶ 予約実行 (Execute booking)
  - ▶ Operate following the instructions on the display.(You can set a timer recording also by highlighting a program and pressing )

## About remote timer recording function

If you have a DVD recorder, etc. that supports the remote timer recording function, you can set timer recordings from the program list of this application program over the Internet even if you are away.

For remote timer recording, you need to make initial settings of this application program.

### How to make initial settings

1. Set the Internet connection for the DVD recorder, etc.  
(Refer to the instruction manual of the DVD recorder, etc. you use.)
2. Software list▶Gガイド番組表リモコン (G Guide Program List Remote-controller)
  - ▶  ()▶ リモート録画予約 (Remote timer recording)
  - ▶ Operate following the guidance.

### How to set timer recordings

After the initial settings, specify your desired program and select "リモート録画予約 (Remote timer recording)". Then, the DVD recorder, etc. specified on this application program is connected via the Internet, and you can set timer recordings.

- You are separately charged a packet communication fee.

## iD設定アプリ (iD Setting Application)

Chargeless electronic money "iD" is a service that enables you to do shopping by placing your Osaifu-Keitai or a credit card with "iD" mounted over a scanning device. You can do shopping easily and conveniently without signing. Depending on the card publishing company, cashing is also supported.

- For using "iD", you need to subscribe to a card publishing company that supports "iD" as well as to have Osaifu-Keitai on which specified settings have been completed by the iD application program or card application program provided by the card publishing company, or a credit card on which "iD" is mounted.

- When you use "iD" on Osaifu-Keitai, you need to complete iD application settings and then make settings at the card application end by downloading or starting the card application provided by your card publishing company. Depending on the card you use, you might be able to use iD only with the settings at the card application end, without any iD application settings.
- The expense (annual fees, etc.) charged for the iD service differs depending on the card publishing company.
- For the information about "iD", refer to the i-mode site of "iD".  
i-mode site:  Menu→メニューリスト (Menu List)→「iD」

※ The display is for reference.  
The actual one may differ.



QR code for  
accessing the site

## DCMXクレジットアプリ (DCMX Credit Application)

"DCMX" is a credit service that supports "iD" and offered by NTT DOCOMO, INC. DCMX provides DCMX mini that enables you to use up to ¥10,000 per month and respective DCMX/DCMX GOLD services that enable you to use more amount and save up DOCOMO points.

With "DCMX mini", you can easily make a subscription from this application program and immediately use Mobile Phone Credit.



※ The display is for reference.  
The actual one may differ.

Subscribing for membership/Screening ※1

Setting card information

### Use

No troublesome deposit is required! Just by placing the mobile phone with the card information setting completed, at a shop where the following iD mark is put up, you can enjoy shopping without signing※2.



### Check

You can check, on the application program, the balance for the current month※3, and detailed account!

### Change

You can perform setting from the application program when changing models or updating your validity period.

※1 The online screening is conducted at your subscription for DCMX mini. For subscribing to a service other than "DCMX mini", you are connected to the subscription page for i-mode.

※2 You might be required to enter your pin number under certain conditions.

※3 Available for DCMX mini only.

● For service contents and details of subscriptions, refer to the i-mode site of DCMX.

· i-mode site: ☎ Menu→DCMX iD



QR code for accessing the site

## Information

- To start this application program for the first time, you need to agree with "ご利用上の注意 (Cautions in use)".
- You are charged a packet communication fee for settings and operations.

## ■ Cautions on Osaifu-Keitai compatible i-oppl

Note that we take no responsibility for any information set on your IC card.

## FOMA 通信環境確認アプリ (FOMA Communication Environment Check Application)

"FOMA 通信環境確認アプリ (FOMA Communication Environment Check Application)" enables you to check whether the FOMA phone is available at the FOMA High-Speed Area.

- Use "FOMA 通信環境確認アプリ (FOMA Communication Environment Check Application)" with your consent to "ご利用上の注意 (Cautions in use)".
- Depending on the communication environment (such as weather, radio wave conditions, network congestion state) at the time of communication environment check, the different result or "out of service" might appear even in the same area or at the same period of time.
- You might not be able to check correctly if you use another function while using this application program.



※ The display is for reference.  
The actual one may differ.

## Setting i-oppai

- 1 i-oppai oppai settings  
▶ Do the following operations.

Item	Operation/Explanation
Auto start setting	See page 234.
Disp. software info	See page 221.
Preferred tone	You can set which sound to be output preferentially, from MUSIC or i-oppai program, for when you start an i-oppai program during music playback. ▶ MUSIC or  oppai
$\alpha$ Backlight	You can set the backlight operation for when an i-oppai program is running. ▶ Select an item. Depend on system . . . . Follows the setting of "Backlight". Depend on software . . . Follows the setting of each software program. Constant light . . . . . Lights constantly.
$\alpha$ Power saver	You can set to Power Saver Mode to decrease battery consumption by suspending the i-oppai program temporarily for when you close the FOMA phone during i-oppai running. ▶ ON or OFF • This setting is valid from when an i-oppai program starts until it closes. • Even when this function is set to "ON", Power Saver Mode becomes invalid if "Power saver" that can be set for each i-oppai program is set to "OFF".
$\alpha$ Vibrator	You can set the vibrator operation for when an i-oppai program is running. ▶ Depend on system or Depend on software Depend on system . . . . Does not work regardless of the setting of "Vibrator". With some software programs, the vibrator works. Depend on software . . . Follows the setting of each software program.
Check settings	You can check each of " oppai settings".

### Information

< $\alpha$ Backlight> < $\alpha$ Vibrator>

- With some software programs, the backlight and vibrator settings are "OFF". Consequently, if you set "Depend on software", the backlight and vibrator will not work; if you want them to work, set "Depend on system".

## Starting i-oppai Automatically

You can make an i-oppai program start automatically at the set date and time. Set the date and time for automatic start using Auto Start Time.

### Auto Start Setting

You can set whether to enable automatic start of i-oppai programs.

- 1 i-oppai oppai settings ▶ Auto start setting  
▶ ON or OFF

### Auto Start Time

You can set the date and time for automatic start. You can set for up to three software programs.

- 1 Software list (FUNC) ▶ Auto start time
- 2 Put a check mark for an item to be set (Finish)  
Time interval set . . . . Starts at an interval specified by the software program. The setting is completed.  
Start time set . . . . . Starts at the set start time automatically.
- 3 Select start time ▶ Enter the date and time to be set.
- 4 1 time ▶ Select a type of repeat.  
• If you select "Weekly", put a check mark for days of the week to be set and press (Finish).



## 5 Press (Finish).

### Auto Start Info

You can check whether a software program has started automatically and properly. Also, you can check the information of start failure from IC card. Up to three records of automatic start, a record of automatic start set by i- $\alpha$ pli, and a record of start failure from IC card are stored.

#### 1 $\triangleright$ i- $\alpha$ pli $\triangleright$ $\alpha$ pli info $\triangleright$ Auto start info

**StartO** . . . . .Started automatically and properly.

**StartX** . . . . .Did not start automatically.

When "Start" is displayed, you can press  (Start) to start the software program.

**Start-** . . . . .Has not started yet.

### Information

- Software programs do not start automatically in the following cases:
  - When the FOMA phone is turned off
  - When the date and time are not set
  - When another function is working
  - During Lock All
  - During Personal Data Lock
  - During playback of animations/Flash movies
  - When the time set for automatic start is identical to the reserved time set for "Software update", or the time set for an alarm of "Alarm", "Schedule" or "ToDo", "Book program" or "Timer recording"
  - When a start time has been specified to the same software program within 10 minutes from the previous auto-start
- If automatic start fails, "  $\alpha$ pli" appears on the desktop. Select the icon to bring up the Auto Start Info.

## <i- $\alpha$ pli Stand-by Display>



# Operating i- $\alpha$ pli Stand-by Display

### Software Setting (Stand-by Set)

You can set an i- $\alpha$ pli program for the Stand-by display. Once set, the i- $\alpha$ pli Stand-by display automatically appears each time you bring up the Stand-by display.





#### 1 Software list $\triangleright$ (FUNC) $\triangleright$ Software setting $\triangleright$ Stand-by set $\triangleright$ ON or OFF $\triangleright$ (Finish)



"" is displayed for the software program set as the Stand-by display.

"" or "" is displayed while an i- $\alpha$ pli Stand-by display is running.

### To operate an i- $\alpha$ pli program as a normal i- $\alpha$ pli program when an i- $\alpha$ pli Stand-by display is running

From the i- $\alpha$ pli Stand-by display, press .

"" or "" changes to a blinking "" or "" and then you can operate the i- $\alpha$ pli program as a normal one.

- To return to the i- $\alpha$ pli Stand-by display, press and hold  for at least one second or press ; then select "Ended". To release the i- $\alpha$ pli Stand-by display, select "Terminated", and select "YES".

### Information

- If you turn off the FOMA phone while the i- $\alpha$ pli Stand-by display is running, the confirmation display appears asking whether to start the i- $\alpha$ pli program when you turn on the power again.
- You can set only one software program for the i- $\alpha$ pli Stand-by display.
- Some i- $\alpha$ pli programs cannot be set for the Stand-by display.
- With some software programs set as the i- $\alpha$ pli Stand-by display, you can press a key to go from the normal i- $\alpha$ pli status to the i- $\alpha$ pli Stand-by display status. However, you cannot return to the i- $\alpha$ pli Stand-by display if another menu function is running.
- Note that you might not be able to receive timely information if you have set "Software setting (Stand-by net)" to "OFF".
- You cannot use the Web To function and the Phone To/AV Phone To function from the i- $\alpha$ pli Stand-by display.
- If the software program which connects to the network is set for the i- $\alpha$ pli Stand-by display, it might not operate successfully because of radio wave conditions or other factors.

## Information

- When you bring up the Stand-by display while a menu function is operating, the image set for "Stand-by display" of "Display setting" will be displayed, even when the i-αpli Stand-by display is set.
- When communicating frequency is extremely high in a certain period of time while an i-αpli program is running as the i-αpli Stand-by display, the confirmation display appears. When you press **(CLR)**, the confirmation display appears asking whether to continue communication.
- If you set Lock All or Personal Data Lock when the i-αpli Stand-by display is shown, the i-αpli Stand-by display will end. If you set Lock All, the image set for "Stand-by display" of "Display setting" will be displayed and if you set Personal Data Lock, the default Stand-by display will be displayed. The i-αpli Stand-by display will return when you release each lock.

## Software Setting (Stand-by Net)

You can set whether to permit communication for when the i-αpli Stand-by display is running.

- 1 **Software list** ▶ **(i-α)** **(FUNC)** ▶ **Software setting**  
▶ **Stand-by net** ▶ **ON or OFF** ▶ **(Finish)**

## End Stand-by Display

You can temporarily end the running i-αpli Stand-by display. Also, you can release the i-αpli Stand-by display.

- 1 **(MENU)** ▶ **Settings** ▶ **Display** ▶ **Display setting**  
▶ **Stand-by display** ▶ **End** **(i-α)** **αpli display**  
▶ **End or Terminate**
- When you select "Terminate", select "YES".

## End Stand-by Info

When the i-αpli Stand-by display does not end successfully, you can check the date/time and its reason.

- 1 **(MENU)** ▶ **i-αpli** ▶ **(i-α)** **αpli info** ▶ **End stand-by info**
- When "**(FUNC)**" is displayed on the End Stand-by Info display, press **(i-α)** **(FUNC)**, and select "Copy info" to copy the information. Select "Delete info", and select "YES" to delete the information.

## < (i-α) αpli(microSD) >

## Displaying i-αpli Data Files on the microSD Card

Depending on the i-αpli program, you can save its data files on the microSD card.

You can display the i-αpli data files saved on the microSD card.

- 1 **(MENU)** ▶ **i-αpli** ▶ **(i-α)** **αpli(microSD)** ▶ **(i-α)** **αpli(microSD)**

## Function Menu while i-αpli Data File is Displayed

Function menu	Operation/Explanation
Folder info	You can display the information of the software program that uses the selected folder, available/unavailable for folder usage, and the reason if unavailable.
Delete folder	You can delete the selected folder and files in the folder. ▶ <b>Enter your Terminal Security Code</b> ▶ <b>YES</b>

# Osaifu-Keitai/ToruCa

What is Osaifu-Keitai? .....	238
What is iC Transfer Service? .....	238
Starting Osaifu-Keitai Compatible i-oppai .....	<IC Card Content> 239
What is ToruCa? .....	<ToruCa> 240
Obtaining ToruCa Files .....	<Obtain ToruCa Files> 240
Displaying ToruCa Files .....	<ToruCa Viewer> 241
How to See ToruCa File List/Detailed ToruCa File Display ...	243
Setting about ToruCa .....	<ToruCa Settings> 246
Locking IC Card Function .....	<IC Card Lock> 246

## What is Osaifu-Keitai?

Just by placing the FOMA phone over the scanning device in a shop, Osaifu-Keitai enables you to make payment and use it as a reward card or coupons.

Further, you can take advantage of communications to deposit electronic money or to check your account for balance or usage details. Security is fully secure so that you can make use with a sense of security.

For details, refer to “Mobile Phone User’s Guide [i-mode] FOMA version”.

※ To use the Osaifu-Keitai compatible service, you need to download the Osaifu-Keitai compatible i-appli program from the Osaifu-Keitai compatible site<sup>※1</sup> to make the settings.

※1 i-mode site (Japanese only): ☎ Menu→メニューリスト (Menu List)  
→おサイフケータイ (Osaifu-Keitai)

- Data on the IC card (including electronic money, reward points, etc.) might be lost or deformed owing to the malfunction of the FOMA phone. (When we keep your FOMA phone for repair, we cannot keep it with data files left, so the data files shall be deleted beforehand by yourself as a rule.) For supports such as reissue, restoration, temporary storage, or transfer of data files, consult the service provider which supports Osaifu-Keitai, except for the data transfer by iC transfer service. For your important data files, be sure to use the service with backup support.
- In any case including malfunction or model change, we cannot be held responsible for the loss or deformation of data on the IC card or other losses caused regarding Osaifu-Keitai compatible services.
- If your FOMA phone is stolen or lost, inquire of the provider for Osaifu-Keitai compatible service you use about ways of dealing with the trouble, immediately. With this FOMA phone, you can use Omakase Lock or IC Card Lock. (See page 117 and page 246)

## What is iC Transfer Service?

iC transfer service<sup>※1</sup> is the service for moving<sup>※2</sup> a package of data files<sup>※3</sup> on the IC card of your Osaifu-Keitai to your new Osaifu-Keitai when you replace your Osaifu-Keitai such as at the time of phone model change or malfunction.

After moving data files on the IC card, just download<sup>※4</sup> an Osaifu-Keitai compatible i-appli program, and then you can easily use the Osaifu-Keitai services. iC transfer service is available at the service counters such as a nearby DOCOMO shop.

For details, refer to “Mobile Phone User’s Guide [i-mode] FOMA version”.

※1 Both the transferring end and transferred end have to be the FOMA phone that supports iC transfer service. Visit a nearby counter such as a DOCOMO shop to use iC transfer service.

※2 This service is not for “copying” but for “moving” data files, so no data files on the IC card remain in the FOMA phone at the transferring end. iC transfer services is not available for some cases, so use backup services for Osaifu-Keitai compatible services.

※3 Some Osaifu-Keitai compatible services do not cover iC transfer service, and you can move only the files on the IC card of the Osaifu-Keitai compatible service that covers iC transfer service.

※4 You are charged a packet communication fee for downloading i-appli programs and respective settings.

## Starting Osaifu-Keitai Compatible i-appli

### Read and Write Data inside the IC Card

You can start the Osaifu-Keitai compatible i-appli from the Software list. By using Osaifu-Keitai compatible i-appli, you can read/write the data inside the IC card and use convenient functions such as depositing electronic money or traffic tickets, or checking your account for the balance and usage details on the mobile phone.

- Take care of your Terminal Security Code and password used for each service not to reveal to anyone.
- When you start or download the Osaifu-Keitai compatible i-appli program for the first time, the message "Use IC card for current UIM?" appears. When you select "YES", you cannot use the IC card function afterward unless you insert the same UIM. To use the IC card function with another UIM, insert the currently supported UIM first, and then delete all the Osaifu-Keitai compatible i-appli programs. Otherwise, you cannot use it.
- Reading and writing data from the software program and to the IC card is suspended in the following cases:  
In that case, the read or written data is discarded. The operation after the communication ends differs depending on the service you use.
  - When a call comes in while an i-appli program is running
  - When the battery goes flat

### 1 Osaifu-Keitai ▶ IC card content

The list of the Osaifu-Keitai compatible i-appli programs is displayed. When you select an i-appli program, it starts up.

- See page 221 for the Software list.

### Use Osaifu-Keitai

Place the FeliCa mark "" of the FOMA phone over the scanning device, and you can use the FOMA phone as electronic money to pay for shopping or to use it as a traffic ticket. This function is available without starting the software program.

- During a call or i-mode connection, you can use Osaifu-Keitai by placing the FeliCa mark over the scanning device, however, you cannot start the Osaifu-Keitai compatible i-appli.

### 1 Place the FeliCa mark "" of the FOMA phone over the scanning device to use the target service.

- The Call/Charging indicator lights when you bring your FOMA phone close to a scanning device and communication becomes ready.

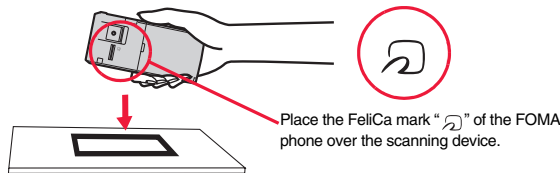

### Information

- Mount the battery pack to use Osaifu-Keitai. Even when the power is turned off or when the battery has gone flat, you can use Osaifu-Keitai by placing the FeliCa mark over the scanning device, however, you cannot start the Osaifu-Keitai compatible i-appli. You might not be able to use Osaifu-Keitai if you have left the battery unused for a long period or not charged it after the low battery alarm sounds. Charge the battery.
- When the FeliCa mark "" of the FOMA phone placed over the scanning device is not identified, slightly move the mark forwards, backwards, to left, or to right.
- Osaifu-Keitai compatible i-appli might start when you place the FOMA phone over the scanning device.

<ToruCa>

## What is ToruCa?

ToruCa is an electronic card that you can obtain with Osaifu-Keitai for use as fliers, restaurant cards, and coupon tickets.

You can obtain ToruCa files from scanning devices or sites and can easily exchange them using mail, infrared ray, or a microSD card.

The obtained ToruCa files are saved to "ToruCa" of "Osaifu-Keitai".

• Available on the ToruCa compatible model. For details, refer to "Mobile Phone User's Guide [i-mode] FOMA version".

### Flow for using ToruCa

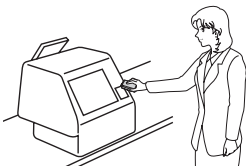

Place your Osaifu-Keitai over a scanning device to obtain a ToruCa file.

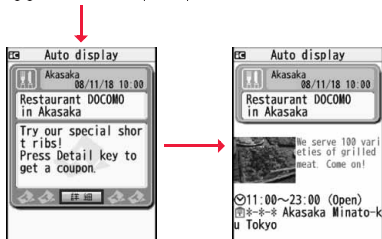

You can view more detailed information by using "詳細 (Details)" key.

### Sources of ToruCa files

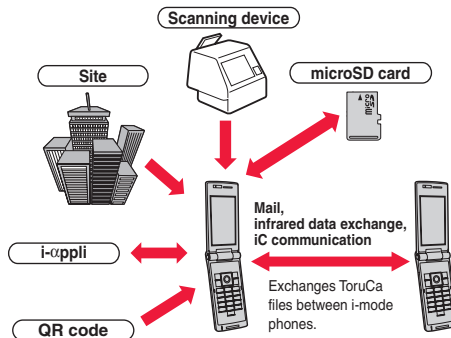

<Obtain ToruCa Files>

## Obtaining ToruCa Files

### Obtain from Scanning Device

You can obtain the ToruCa file from a scanning device using the IC card function. By obtaining detailed information, a ToruCa file becomes a ToruCa file (details) which has more pieces of information.

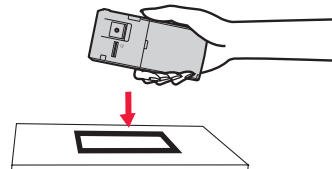

• For a ToruCa file (details), you can download up to 100 Kbytes per file, and for a ToruCa file before obtaining the details, you can download up to 1 Kbyte per file.

**1** Place the FeliCa mark "☞" of the FOMA phone over the scanning device.



## When the ToruCa file is obtained

A ToruCa obtained tone sounds, the Call/Charging indicator lights.

- When "Receiving display" is set to "ON", detailed display of obtained ToruCa file appears.
- For a ToruCa file before obtaining detailed information, the confirmation display appears asking whether to connect to a site to download detailed information. Select "YES" to display a ToruCa file (details) with detailed information obtained. Select "NO" to display a ToruCa file without detailed information.
- If no keys are pressed for about 15 seconds or "Receiving display" is set to "OFF", "NEW" appears on the desktop.  
Press , highlight , and press  (Select); then the ToruCa File list appears.

## About Auto-reading Function of ToruCa

If you set "Auto reading" to "Accept" to use the ToruCa files by placing the FOMA phone over the scanning device, the available ToruCa files are automatically recognized. The used ToruCa files are converted into "Used" and then moved to the "Used ToruCa" folder. Up to 20 used ToruCa files are saved, and when the number of the files exceeds 20, the files are deleted from the one downloaded at the oldest date.

- Even if "Auto reading" is set to "Reject", the confirmation display might appear asking whether to use "Auto reading" when you place the FOMA phone over the scanning device. To use ToruCa files, select "YES", and then set "Auto reading" to "Accept".

### Information

- When you fail to obtain a ToruCa file, the ToruCa failed-to-obtain tone sounds, and the Call/Charging indicator lights.
- A ToruCa obtained tone and a ToruCa failed-to-obtain tone sound at the volume set for "Phone" of "Ring volume".
- Depending on the settings by IPs (Information Providers), you might not be able to update ToruCa files or send them by mail or infrared rays.

<ToruCa Viewer>

## Displaying ToruCa Files

You can display the ToruCa file obtained using the IC card function, or from sites or mail.

### 1 ▶ Osaifu-Keitai ▶ ToruCa ▶ Select a folder.

- Each time you press  from the ToruCa Folder list, you can switch folders between the FOMA phone and the microSD card.
- When the folder contains unread ToruCa files, "NEW" appears.

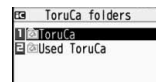

ToruCa Folder list

### 2 Select a ToruCa file.

## When obtaining detailed information from a ToruCa file

A ToruCa file before obtaining detailed information itself does not show the detailed information. Select "詳細 (Details)" on the ToruCa file display and select "YES" to connect to the site to obtain more detailed information.



After obtaining the detailed information, the ToruCa file is overwritten and saved.

### Information

- You are charged the ordinary packet fee for obtaining.

## Function Menu of the ToruCa Folder List

Function menu	Operation/Explanation
<b>Operate folder (Add folder)</b>	<p>You can create a user folder. You can create up to 20 folders.</p> <p>▶ <b>Add folder</b> ▶ <b>Enter a folder name.</b></p> <ul style="list-style-type: none"> <li>• You can enter up to 10 full-pitch/20 half-pitch characters for the FOMA phone.</li> <li>• You can enter up to 31 full-pitch/63 half-pitch characters for the microSD card.</li> </ul>
<b>Operate folder (Edit folder name)</b>	<p>You can edit the folder name for the user folder.</p> <p>▶ <b>Edit folder name</b> ▶ <b>Enter a folder name.</b></p> <ul style="list-style-type: none"> <li>• You can enter up to 10 full-pitch/20 half-pitch characters for the FOMA phone.</li> <li>• You can enter up to 31 full-pitch/63 half-pitch characters for the microSD card.</li> </ul>
<b>Operate folder (Delete folder)</b>	<p>All ToruCa files in the folder are deleted.</p> <p>▶ <b>Delete folder</b> ▶ <b>Enter your Terminal Security Code</b> ▶ <b>YES</b></p>
<b>Search all folders</b>	<p>You can search through all ToruCa files in the FOMA phone (except ToruCa files stored in the "Used ToruCa" folder) by specifying a search condition.</p> <p>▶ <b>Select a search condition.</b></p> <p><b>Genre</b> . . . Select a genre.</p> <p>Press  (<b>Detail</b>) to display a list of category icons belonging to the genre.</p> <p><b>Title</b> . . . . . Enter characters to be searched for, from those in the title.</p> <p><b>Index</b> . . . Enter characters to be searched for, from those in location data.</p> <ul style="list-style-type: none"> <li>• You can enter up to 20 full-pitch/40 half-pitch characters for the Title search, and up to 10 full-pitch/20 half-pitch characters for the Index search.</li> </ul>

Function menu	Operation/Explanation
<b>Auto-sort</b>	<p>You can set to automatically sort and save the ToruCa files that satisfy the conditions set to the folder for when you obtain them from a scanning device.</p> <p>▶ <b>Select a sorting condition.</b></p> <p><b>Genre</b> . . . . . Put a check mark for the genre to sort into and press  (<b>Finish</b>). You can put it for multiple genres.</p> <p><b>Title</b> . . . . . Enter characters from those in the title, to be a sorting condition.</p> <p><b>Index</b> . . . . . Enter characters from those in the location data, to be a sorting condition.</p> <p><b>Release</b> . . . Select "YES" to release the sorting condition you specified.</p> <ul style="list-style-type: none"> <li>• You can enter up to 20 full-pitch/40 half-pitch characters for the Title sort, and up to 10 full-pitch/20 half-pitch characters for the Index sort.</li> <li>• When a sorting condition is already specified for the folder, it is displayed. Press  (<b>FUNC</b>) to set a sorting condition again.</li> </ul>
<b>Copy (Copy to microSD)</b>	<p>You can copy the ToruCa files together with the folder from the FOMA phone to the microSD card.</p> <p>▶ <b>Copy to microSD</b></p>
<b>Copy (CPY all to microSD)</b>	<p>You can copy all the ToruCa files together with the folder from the FOMA phone to the microSD card.</p> <p>▶ <b>CPY all to microSD</b> ▶ <b>Enter your Terminal Security Code</b> ▶ <b>YES</b></p>
<b>Copy (Copy to phone)</b>	<p>You can copy the ToruCa files together with the folder from the microSD card to the FOMA phone.</p> <p>▶ <b>Copy to phone</b></p>
<b>Copy (Copy all to phone)</b>	<p>You can copy all the ToruCa files together with the folder from the microSD card to the FOMA phone.</p> <p>▶ <b>Copy all to phone</b> ▶ <b>Add or Overwrite</b> ▶ <b>Enter your Terminal Security Code</b> ▶ <b>YES</b></p> <ul style="list-style-type: none"> <li>• When you select "Overwrite", the confirmation display appears telling that the ToruCa files in the FOMA phone will be deleted.</li> </ul>



Function menu	Operation/Explanation
lr/  transmission (Send all lr data)	See page 320.
lr/  transmission (All  transmission)	See page 322.
Memory info	You can display the used memory space (estimate)/the number of saved files.
Delete all	You can delete all the ToruCa files stored in the FOMA phone. ▶ Enter your Terminal Security Code ▶ YES
Select storage	You can set a destination folder for when copying from the FOMA phone to the microSD card. ▶ YES

## Information

### <Auto-sort>

- " " is displayed when the Genre sort is set, " " is displayed when the Title sort is set, and " " is displayed when the Index sort is set.
- When a file satisfies multiple conditions, it is sorted into the top of the folder in the ToruCa Folder list.

### <Copy (Copy to microSD)>

- The ToruCa file (details) is copied as a ToruCa file before obtaining details if it contains the data file with the UIM security or whose output from the FOMA phone is prohibited.

### <Copy (CPY all to microSD)>

- The ToruCa files in the "ToruCa" folder within the FOMA phone are saved to "SD ToruCa" on the microSD card.

### <Copy (Copy all to phone)>

- The ToruCa files in "SD ToruCa" on the microSD card are added or overwritten and then saved to the "ToruCa" folder in the FOMA phone.

### <Select storage>

- " " is displayed for the folder set as a destination.
- When you execute Check microSD, or create or edit a folder by using a personal computer, the destination folder on the microSD card might be changed. When the setting is changed, set the destination folder again.

## How to See ToruCa File List/Detailed ToruCa File Display

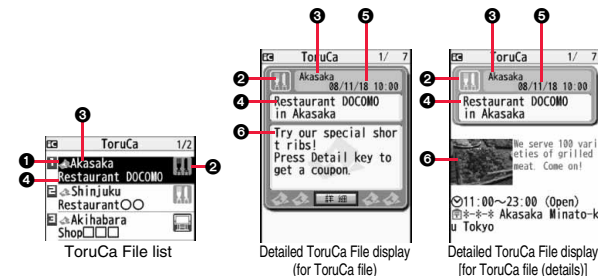

### 1 Indicates the state of ToruCa file

※1	Unread ToruCa file
	Read ToruCa file
※2	FOMA phone incompatible ToruCa file

※1 Does not apply to the ToruCa file downloaded from a site.

※2 Appears for only the ToruCa file on the microSD card.

• " " is added to the expired ToruCa file.

• " " is added to the ToruCa file whose output from the FOMA phone is prohibited.

### 2 Indicates the category

Displays a category icon that matches the contents of the ToruCa file.

### 3 Indicates the Index file

Displays the location data of the publisher that publishes the information about the ToruCa file.

### 4 Indicates the title





### 5 Indicates the date and time the ToruCa file was obtained



### 6 Indicates the ToruCa information

Simple explanation and the "詳細 (Details)" key are displayed for a ToruCa file.

Information about the publisher is displayed for a ToruCa file (details).

## Function Menu of the ToruCa File List/Detailed ToruCa File Display

Function menu	Operation/Explanation
<b>Attach to mail</b>	You can compose an i-mode mail message with the ToruCa file attached. Go to step 2 on page 174. ● You can compose it also by pressing   .
<b>Move</b>	▶ <b>Select a destination folder.</b> ● You cannot select the "Used ToruCa" folder.
<b>Search/sort (Search)</b> [List only]	You can search through ToruCa file in the folder by specifying a search condition. ▶ <b>Search ▶ Select a search condition.</b> <b>Genre . . .</b> Select a genre. Press   to display a list of category icons belonging to the genre. <b>Title . . . . .</b> Enter characters to be searched for, from those in the title. <b>Index . . . . .</b> Enter characters to be searched for, from those in location data. ● You can enter up to 20 full-pitch/40 half-pitch characters for the Title search, and up to 10 full-pitch/20 half-pitch characters for the Index search.
<b>Search/sort (Sort)</b> [List only]	You can change the order of displayed files. ▶ <b>Sort ▶ Select an order.</b>
<b>Copy (Copy)</b>	You can copy the displayed or highlighted ToruCa file to another folder. ▶ <b>Copy ▶ Select a destination folder.</b> ● You cannot select the "Used ToruCa" folder.
<b>Copy (Copy to microSD)</b>	The files are copied to the folder as specified by "Select storage" on page 243. ▶ <b>Copy to microSD</b>
<b>Copy (Copy to phone)</b>	You can copy the ToruCa file from the microSD card to the ToruCa folder in the FOMA phone. ▶ <b>Copy to phone</b>

Function menu	Operation/Explanation
<b>Multiple-choice</b> [List only]	You can select multiple ToruCa files and operate them. ▶ <b>Put a check mark for ToruCa files to be selected</b> ▶   ▶ <b>Select an item.</b> <b>Move . . . . .</b> See page 244. <b>Copy . . . . .</b> See page 244. <b>Copy to microSD . . . . .</b> See page 244. <b>Copy to phone . . . . .</b> See page 244. <b>Send Ir data . . . . .</b> See page 319. <b>Select all . . . . .</b> Selects all files. <b>Release all . . . . .</b> Releases all selections.
<b>Update ToruCa</b> [Detailed display only]	You can re-obtain the information about the ToruCa file. The re-obtained ToruCa file (details) is automatically overwritten and then saved. ▶ <b>YES</b> ● You cannot update some ToruCa files. ● See page 163 for when ToruCa files are stored to the maximum.
<b>Operate image (Save image)</b> [Detailed display only]	You can save the image displayed on the ToruCa file and set it for the Stand-by display or Wake-up display. ▶ <b>Save image ▶ Select an image ▶ YES</b> ▶ <b>Select a destination folder.</b> Go to step 3 on page 160. ● See page 163 for when images are stored to the maximum.
<b>Operate image (Save BG image)</b> [Detailed display only]	You can save the background image of the ToruCa file and set it for the Stand-by display or Wake-up display. ▶ <b>Save BG image ▶ YES ▶ Select a destination folder.</b> Go to step 3 on page 160. ● See page 163 for when images are stored to the maximum.
<b>Operate image (Retry)</b> [Detailed display only]	You can play back an animation image or Flash movie in the ToruCa file from the beginning. ▶ <b>Retry</b> ● When a part of the Flash movie is outside the display area, the Flash movie might not be played back.
<b>Add to phonebook</b> [Detailed display only]	See page 82.
<b>Add desktop icon</b>	See page 109.

Function menu	Operation/Explanation
Ir/  transmission (Send Ir data)	See page 319.
Ir/  transmission ( transmission)	See page 321.
<b>Memory info</b> [List only]	You can display the used memory space (estimate)/the number of saved files.
<b>Delete</b> (Delete this) [List only]	▶ Delete this ▶ YES
<b>Delete</b> (Delete selected) [List only]	▶ Delete selected ▶ Put a check mark for ToruCa files to be deleted ▶  (Finish) ▶ YES
<b>Delete</b> (Delete all) [List only]	You can delete all ToruCa files in the folder. ▶ Delete all ▶ Enter your Terminal Security Code ▶ YES
<b>Delete</b> [Detailed display only]	▶ YES

### Information

#### <Attach to mail>

- The ToruCa file (details) that contains data whose output from the FOMA phone is prohibited is attached as a ToruCa file before obtaining details.
- You might not be able to attach the ToruCa file to i-mode mail depending on its file size.

#### <Copy (Copy)>

- You cannot copy ToruCa files whose output from the FOMA phone is prohibited.

### Information

#### <Copy (Copy to microSD)>

- The ToruCa file (details) is copied as a ToruCa file before obtaining details if it contains the data file with the UIM security or whose output from the FOMA phone is prohibited.
- When the number of files in the destination folder on the microSD card is full, a new folder is automatically created and ToruCa files are saved to that folder. When copying is completed, the message "This folder is set for storage XXXXXXXX" (XXXXXXX denotes a folder name) appears.
- The name of copied ToruCa file is TORUCXXX (XXX denotes a numeral).
- When no folder is set as a destination folder on the microSD card, a new folder is created automatically and the file is saved to the folder. After saving, the newly created folder is set as the destination folder.
- You might not be able to execute "Copy to microSD" for the ToruCa file depending on its file size.

#### <Copy (Copy to phone)>

- You might not be able to execute "Copy to phone" for the ToruCa file depending on its file size.

#### <Operate image>

- The image satisfying the following conditions is saved as a frame or mark:
  - Transparent GIF file that is not an animation GIF file
  - The file extension is "ifm".
  - Images of Stand-by (240 x 427), CIF (352 x 288), QVGA (240 x 320), QCIF (176 x 144), or Sub-QCIF (128 x 96) are saved as frames; and images of Stand-by (240 x 427) or smaller except frames are saved as marks.

## Setting about ToruCa

- 1**  **Osaifu-Keitai** ▶ **Settings**  
▶ **Do the following operations.**

Item	Operation/Explanation
<b>Receive ToruCa</b>	You can set whether to obtain ToruCa file from a scanning device using the IC card function. ▶ <b>Accept or Reject</b>
<b>Receiving display</b>	You can set whether to display the detailed ToruCa File display when you obtain a ToruCa file while the Stand-by display is shown. ▶ <b>ON or OFF</b>
<b>Check same data</b>	You can set whether to check the same ToruCa file is already obtained before obtaining a ToruCa file from a scanning device or obtaining a ToruCa file automatically from data broadcasting while watching a 1Seg program. ▶ <b>ON or OFF</b> <b>ON</b> . . . Checks and does not obtain a new ToruCa file if the same ToruCa file is already obtained. <b>OFF</b> . . . Does not check. Obtains even the same ToruCa file.
<b>Auto reading</b>	You can set whether to have the available ToruCa files automatically recognized for when you place the FOMA phone over the scanning device. ▶ <b>Accept or Reject</b>

### Information

#### <Check same data>

- The ToruCa files stored in the "Used ToruCa" folder or expired ToruCa files are not included in target files.

#### <Auto reading>

- If "Auto reading" is set to "Reject", you might not be able to use ToruCa files.

## Locking IC Card Function

To prevent the IC card function from being used by others, you can set the Osaifu-Keitai, obtained ToruCa, or IC communication disabled.

- If the battery runs out while IC Card Lock is set, the IC card stays locked.

- 1** Press and hold  for at least one second.

"" appears and IC Card Lock is set.

- To release IC Card Lock, perform the same operation and enter your Terminal Security Code. When Timer Lock ON At Close is set, the display for releasing IC Card Lock appears also by opening the FOMA phone.

### IC Lock (Power-off)

You can set whether to lock the IC card function while the power is turned off.

- 1**  ▶ **Settings** ▶ **Lock/Security**

or

-  ▶ **Osaifu-Keitai** ▶ **IC card lock set.**

- 2** **IC lock (power-off)**

- ▶ **Enter your Terminal Security Code** ▶ **Select an item.**

**Setting before OFF** . . . . Follows the setting just before turning off the power.

**Lock** . . . . . Sets IC Card Lock.

# 1Seg

What is 1Seg? .....	248
Before Using 1Seg.....	249
Setting Channels .....	<Channel Setting> 249
Watching 1Seg Programs .....	<Activate 1Seg> 251
Using Program Guide i-appli.....	<Program Guide i-appli> 255
Using Data Broadcasting .....	<Data Broadcasting> 256
Using TV Links .....	<TVlink> 257
Recording a 1Seg Program while Watching .....	257
Booking Programs or Setting Timer Recording of 1Seg .....	<Book Program> <Timer Recording> 259
Settings for 1Seg .....	<User Settings> 263

## What is 1Seg?

1Seg is the terrestrial digital TV broadcasting service for mobile objects, and it broadcasts data as well as video and audio. Further, by using i-mode, you can obtain the detailed information, can participate in quiz programs or can have fun with TV shopping. For details on the 1Seg service, browse to the web page as follows:

社団法人 デジタル放送推進協会 (The association for Promotion of Digital Broadcasting)

From personal computers: <http://www.dpa.or.jp/>

From i-mode: <http://www.dpa.or.jp/1seg/k/> (Japanese only)

### ■ Using 1Seg

- The 1Seg broadcasting is a service provided by television entrepreneurs (broadcasting stations).
- The subscription is not required to receive video, audio and data broadcasting transmitted on the airwaves for the 1Seg service, and its charge is free.
- The information displayed in the data broadcasting area contains "Data broadcasting" and "Data broadcasting site".  
"Data broadcasting" is displayed on airwaves together with video and audio, and "Data broadcasting site" is displayed by connecting from the information of data broadcasting to the sites provided by television entrepreneurs (broadcasting stations). Also, it might be connected to "i-mode site", etc. When connecting to sites, you need to subscribe to i-mode separately.
- You are charged a packet communication fee for browsing "Data broadcasting site" and "i-mode site".  
You might be charged an information fee for using some sites (i-mode pay sites).

### ■ Radio waves

1Seg is one of the broadcasting services receiving radio waves (broadcasting waves) different from that used for the FOMA services. Accordingly, you cannot watch the broadcasting when you are out of reach of the broadcasting waves, or when the broadcasting is suspended regardless of whether you are in or out of the FOMA service area.





Even when you are in the terrestrial digital TV broadcasting service area, reception condition might be deteriorated or you might not be able to receive programs in the following places:

- Where the radio tower that transmits broadcasting waves is far away
- Where the radio waves are blocked by geographical features such as mountains or valleys of high-rise buildings
- Where the radio waves are weak or do not reach, such as in tunnels, underground, or recesses of buildings

The reception conditions might be improved by moving your FOMA phone away from close to you, or moving yourself to another place.

### ■ Messages on the display when you use 1Seg for the first time

When you use 1Seg for the first time after purchase, the Exemption Clause Confirmation display appears.

Press  or  and then press  .

If you select "NO" from the succeeding confirmation display, the same confirmation display does not appear afterward.

- The Exemption Clause Confirmation display also appears when you replace the UIM with another one.

### ■ What is broadcasting storage area?

The broadcasting storage area is a storage area inside the terminal that is exclusive for 1Seg. The information you input according to the instruction on the data broadcasting program is saved to that broadcasting storage area following the settings of television entrepreneurs (broadcasting stations). The information to be saved might contain answers for quiz, and personal information such as membership number, gender, age, or occupation.

The saved information might be displayed, or be sent to television entrepreneurs (broadcasting stations) without your re-input when you browse to the data broadcasting site.

- See page 264 to erase information in the broadcasting storage area.

When you replace the UIM with another one, the confirmation display appears asking whether to reset the broadcasting storage area. Select "YES", and reset it. If you select "NO", the services using the broadcasting storage area are not available.

### ■ Messages on the display when the information in the broadcasting storage area is read out

When the information in the broadcasting storage area is used while you are watching a program, the message "Use saved information? It may include information used by the same broadcasting group" is displayed.

If you select "YES", the confirmation display asking whether to read out the stored information while watching the same program does not appear after that. Further if you select "YES (confirm once)", the same confirmation display does not appear afterward.

## Before Using 1Seg

### How to Watch a 1Seg Program

<Example> When you watch a 1Seg program for the first time

#### STEP

#### 1 Channel Setting

Store the channel list for the area you use. (See page 249)

#### STEP

#### 2 Activating 1Seg

Activate 1Seg. (See page 251)

##### ■ Battery level

If you try to start 1Seg when the battery is low, the battery alert tone sounds, and the confirmation display appears asking whether to start it. Also, when the battery becomes low while you are watching or recording a 1Seg program, the battery alert tone sounds, and the confirmation display appears asking whether to end 1Seg. The battery alert tone sounds regardless of the setting of "Keypad sound".

- When you do nothing from the confirmation display for about one minute, 1Seg automatically terminates.
- While "Rec. when low battery" is set to "ON", the confirmation display does not appear during recording. (See page 263)
- If the battery level becomes low during recording and recording ends, the video recorded up to that point is automatically saved.
- During Multitask, the battery alert tone sounds but the confirmation display does not appear. Switch to the viewer display and then operate.

##### ■ When a call etc. comes in while you are watching or recording a 1Seg program

When an event shown below occurs while watching or recording a 1Seg program, the video and audio are suspended, and each function works. Recording is not suspended. After you finish each function, you can resume watching a 1Seg program.

- Incoming voice call, videophone call
- Receiving i-mode mail, SMS, Message R/F  
(when "Receiving display" is set to "Alarm preferred")  
See page 255 for receiving i-mode mail messages or SMS messages.
- Notification of Alarm, Schedule, ToDo, Book Program  
(when "Alarm setting" is set to "Alarm preferred")
- Notification of Timer Recording  
(When the start date/time comes, the FOMA phone works according to the setting of "Priority".)

### Information

- When you have not inserted the UIM, when you have canceled the contract with DOCOMO, or when you have temporarily suspended using the FOMA service, you cannot watch 1Seg programs.
- Even when you have inserted the UIM contracted with DOCOMO, you might be disabled to start 1Seg if you repeatedly watch 1Seg programs in the condition the FOMA phone cannot communicate such as when you are out of the service area. In that case, try to start 1Seg in the condition the FOMA phone can communicate such as by moving into the FOMA service area.
- When you watch a 1Seg program for the first time, start 1Seg in the FOMA service area.
- 1Seg is not available while "USB mode setting" is set to "microSD mode" or "MTP mode" and the FOMA phone is connected to a personal computer.
- 1Seg might automatically start when you end a call by closing the FOMA phone during a call. In such a case, be careful not to use the FOMA phone close to your ear because audio is output at the sound volume for 1Seg.
- The life of battery pack may shorten if you watch 1Seg programs for a long time during charging.
- 1Seg is not available overseas.

### <Channel Setting>

## Setting Channels

To watch 1Seg programs, you need to execute Channel Setting and to select a channel list in advance. You can store up to 10 channel lists.

- The broadcasting stations you can receive differ depending on the local area. If you store a channel list of the area for traveling or business trip, you can watch programs in the area just by selecting the channel list.
- The remote-control numbers you use with channel selections are previously set for respective broadcasting stations.
- You cannot execute Channel Setting during recording of a 1Seg program.

## Auto Channel Setting

The broadcasting stations you can currently watch are automatically searched and stored in a channel list.



- You need to set this function in the terrestrial digital TV broadcasting service area.

### 1 1Seg ▶ Channel setting ▶ Auto channel setting ▶ YES

Searching takes place.

- From the Channel list display or viewer display, press  ( **FUNC** ), select "Channel setting", and select "Auto channel set".

### 2 YES ▶ Enter a title.

- You can enter up to 11 full-pitch/22 half-pitch characters.
- When you press  ( **Set** ) without entering a title, the title name takes the name of "YYYY/MM/DD hh:mm". (Y: year, M: month, D: date, h: hour, m: minute)
- To cancel searching midway, press  ( **Cancel** ) or  ( **CLR** ); then select "YES". You can store the searched broadcasting stations in a channel list.

## Information

- When the multiple broadcasting stations which have the same remote-control number are retrieved, the message to the effect that the remote-control number is doubled appears. Select "OK" and select your area from the Local Area Selection display. The channels in the area you select are preferentially assigned to remote-control numbers 1 to 12, and channels in the area you do not select are assigned to remote-control numbers 13 onward.
- The time to search channels requires for about 30 to 60 seconds. However, it differs depending on the number of broadcasting stations or airwave conditions, and might exceed 60 seconds.

## Select Area

You can store the broadcasting stations set by prefecture to a channel list.

### 1 1Seg ▶ Channel setting ▶ Select area ▶ Select an area ▶ Select a prefecture ▶ YES

- From the Channel list display or viewer display, press  ( **FUNC** ), select "Channel setting", and select "Select area".

## Information

- Depending on the area, you may not be able to correctly store the broadcasting stations by "Select area". In that case, search for the broadcasting stations by "Auto channel setting".

## Select Channel List

You can select a channel list to set the broadcasting stations you receive. Also, you can edit the channel list already stored.

### 1 1Seg ▶ Channel list ▶ Select a channel list.

The channel list you receive is set, and the detailed display appears.

- Select a broadcasting station to watch a 1Seg program.
- When you select "Channel list" from the Function menu of viewer display, the viewer display returns by selecting a channel list.
- You can watch a 1Seg program also by pressing  ( **Detail** ) from the Channel list display and selecting a broadcasting station.

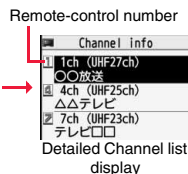

## Function Menu of the Channel List Display

Function menu	Operation/Explanation
Channel setting	See page 249.
Edit title	▶ Enter a title. You can enter up to 11 full-pitch/22 half-pitch characters.
Delete this	▶ YES • You cannot delete the channel list currently set.



## Function Menu of the Detailed Channel List Display

Function menu	Operation/Explanation
<b>Remote control No.</b>	<p>You can change the broadcasting station set for the remote-control number.</p> <ul style="list-style-type: none"> <li>▶ <b>Select a broadcasting station you want to change</b></li> <li>▶ <b>Select the remote-control number to be set.</b></li> </ul> <p>● If any broadcasting station has already been set for the specified remote-control number, the broadcasting stations switch positions. Repeat the operation to set a broadcasting station for a remote-control number.</p> <p>▶ [Finish] ▶ <b>YES</b></p>
<b>Delete this</b>	<p>▶ <b>YES</b></p> <ul style="list-style-type: none"> <li>● When you delete all the broadcasting stations in the channel list, the channel list itself is deleted.</li> <li>● You cannot delete the broadcasting station in the channel list currently set.</li> </ul>

### <Activate 1Seg>

## Watching 1Seg Programs

- When you use 1Seg for the first time, the Exemption Clause Confirmation display appears. (See page 248)
- You can start 1Seg also by using the channel information displayed in the Program Guide i-copli, sites, or mail.

### 1 Press and hold [1Seg] for at least one second.

1Seg starts from the channel you watched last time.

"[1Seg]" is displayed while watching a 1Seg program.

- When you have not stored any channel list, the confirmation display appears. Select "OK" and execute Channel Setting. (See page 249)
- To end watching, press [Power] and select "YES".



Viewer display

### ■ About Viewer display

(When "Switch display" is "V. img+Caption+DBC".)

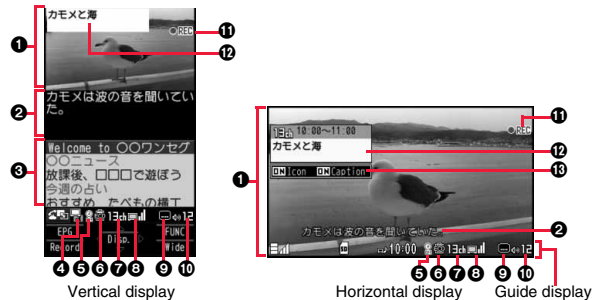

- 1 Video
- 2 Caption
- 3 Data Broadcasting
- 4 Operation Mode
  - ▶ Video Mode: Operates the video or audio. (See page 251)
  - ▶ Data Broadcasting Mode: Operates the data broadcasting. (See page 256)
- 5 Off Timer
  - ▶ "OFF" appears while Off Timer is set.
- 6 ECO Mode
  - ▶ "ECO" appears during ECO Mode.
- 7 Channel (Remote-control number)
- 8 Airwave Reception Level (estimate)
  - ▶ [Signal strength icons] (strong) ↔ (weak)
  - ▶ "No signal" appears out of the broadcasting area.
- 9 Reception of Caption
  - ▶ "REC" is displayed while caption information is being received.
- 10 Sound Volume
- 11 Record Video
  - ▶ "REC" appears during video recording, and "REC" appears during video recording by Timer Recording.
- 12 Program Information (outline)
  - ▶ The program name is displayed on the vertical display. The channel, start/end time, and program name are displayed on the horizontal display. This is displayed when you operate keys.

### Icon/Caption

Icon: "ON/OFF" of "Icon"

Caption: "ON/OFF" of Caption

This is displayed when you operate keys.

- After you select a channel using Channel Search, the channel (Remote-control number) might not be displayed.
- While "Icon" is set to "OFF" and the horizontal display is shown, the guide display appears when you operate keys.

### Channel switching operation (in Video Mode only)

Operation	Key operation
<b>Direct channel selection</b>	Remote control No.1-9 . . . . .  ~ Remote control No.10 . . . . . Remote control No.11 . . . . . Remote control No.12 . . . . .
<b>Channel selection</b>	
<b>Channel search</b>	(for at least one second) • Each time of pressing switches channels by searching receivable broadcasting stations in order of frequency. •  (Cancel) or  to suspend

### Operations while watching a 1Seg program

Operation	Key operation
<b>Sound volume adjustment</b>	※1 or
<b>Mute</b>	※1 •  ※1 or adjust volume to play back sound
<b>Start program guide i-appli</b>	※2
<b>Program info</b>	(for at least one second) ※2
<b>Program info (outline)</b>	 • Each time of pressing switches "ON/OFF" of "Icon" and Caption in the horizontal display.
<b>Vertical/Horizontal display</b>	※1 ※3 • Each time of pressing switches the display direction.

Operation	Key operation
<b>Record video</b>	(for at least one second) •  to end
<b>Record still image</b>	
<b>Switch TV/data BC</b>	※2 • Each time of pressing switches between Video Mode and Data Broadcasting Mode.

※1 In Data Broadcasting Mode, you cannot operate.

※2 You cannot operate from the horizontal display.

※3 When you close the FOMA phone, the vertical display returns.

### Information

- Even when you switch displays by using Multitask while you are watching a 1Seg program, the audio from the 1Seg program is output. (Play Background) The audio might not be output, however, depending on the function or program. (See page 449)
- When "TV sound while closed" is set to "ON", the audio is output even if you close the FOMA phone while you are watching a 1Seg program. You cannot do anything other than adjusting the volume when your FOMA phone is closed.
- The following might occur depending on the airwave conditions:
  - The audio is interrupted.
  - The data broadcasting is not operable.
  - Block-shaped noise appears on the display or playing stops.
  - The video or the data broadcasting is not displayed. (A dark screen appears.)
- The caption might not be displayed depending on the program.
- The data broadcasting cannot be displayed on the horizontal display.
- If you move, the receivable airwaves or broadcasting stations might change being affected by mountains or buildings. If reception on 1Seg goes bad after moving, perform "Auto channel setting"; then reception might be improved via different airwaves or you might be able to watch programs of other broadcasting stations.
- If you use Channel Search to select channels after you move, etc., you might find the channels you could not store by "Auto channel setting". Execute "Add to ch. list" to store the channels you found, and then you can watch the channel from the next time.
- When starting 1Seg or switching channels, it takes a while before you can watch a 1Seg program.

## Function Menu of Viewer Display

Function menu	Operation/Explanation
<b>Channel info</b>	You can display the detailed display of the selected channel list. Select a broadcasting station to switch to it.
<b>Program info</b>	You can display information of the program you are watching.
<b>Channel list</b>	Go to step 1 of "Select Channel List" on page 250.
<b>Channel setting</b>	See page 249.
<b>Add to ch. list</b>	You can add the broadcasting station you are currently watching to the channel list. ▶ <b>YES</b> • The broadcasting station is stored in the lowest number of an unoccupied remote-control number from 13 onward.
<b>Program guide</b>	See page 255.
<b>Switch display</b>	You can switch the contents of the viewer display. ▶ <b>Select an item.</b> • If you set to "Enlarged V. img+DBC", the video on the vertical display is enlarged. However, the sides of the video might be cut depending on the program. • Even if you set to "Data broadcasting", the audio from 1Seg programs is output.
At 1Seg start-up When "Caption" is set to "ON": V. img+Caption+DBC When "Caption" is set to "OFF": Visual image+DBC	
<b>Switch TV/data BC</b>	You can switch between Video Mode and Data Broadcasting Mode while watching a 1Seg program on the vertical display.
At 1Seg start-up Video Mode	
<b>Icon</b>	See page 264.
<b>Compose message</b>	See page 254.

Function menu	Operation/Explanation
<b>Settings (Off timer)</b>	When the specified time elapses, the confirmation display appears asking whether to end watching or recording a program (except for Timer Recording). ▶ <b>Select a time.</b>
At 1Seg start-up OFF	
<b>Settings (Brightness)</b>	You can set the brightness of the display light to Level 1 (dark) through 5 (bright). ▶ <b>Select a brightness level.</b> • If you set to "Auto setting", it is adjusted automatically in accordance with the ambient brightness sensed by the light sensor. • The setting here is valid until you finish watching the 1Seg program. The setting at 1Seg start-up follows the setting specified by "Brightness" of "Backlight" on page 101.
<b>Settings (Image quality)</b>	See page 263.
<b>Settings (LCD AI)</b>	See page 102.
<b>Settings (Auto volume)</b>	See page 263.
<b>Settings (Remaster)</b>	See page 263.
<b>Settings (Listening)</b>	See page 263.
<b>Settings (Equalizer)</b>	See page 263.
<b>Settings (Main/sub sound)</b>	▶ <b>Sound</b> ▶ <b>Main/sub sound</b> ▶ <b>Main sound, Sub sound, or Main+sub sound</b>
At 1Seg start-up Main sound	
<b>Settings (Switch audio data)</b>	▶ <b>Sound</b> ▶ <b>Switch audio data</b> ▶ <b>Sound 1 or Sound 2</b> • You can switch only when audio that can be switched is found.

Function menu	Operation/Explanation
Settings (TV sound w/ closed)	See page 263.
Settings (ECO mode)	See page 263.
Data broadcasting (Reload contents)	You can reload the data broadcasting site being displayed. ▶ <b>Reload contents</b> • The confirmation display appears asking whether to re-send the data you entered, depending on the site.
Data broadcasting (Certificate)	See page 153.
Data broadcasting (Set image display)	See page 165.
Data broadcasting (Sound effect)	See page 264.
Data broadcasting (Reset settings)	See page 264.
Back to data BC	You can stop browsing the data broadcasting site and return to the data broadcasting.
Tune service	You can select a program to watch when the same broadcasting station is broadcasting multiple services (programs). ▶ <b>Select a channel.</b>
TVlink list	You can display the TVlink list. (See page 257)

### Information

#### <Settings (Off timer)>

- In the following cases, the Off Timer confirmation display appears after each operation finishes.
  - During recording standby for Timer Recording
  - During recording by Timer Recording
  - When a still image is being saved
  - When an unsaved image is left
  - During channel search by Auto Channel Setting

## Send i-mode Mail while Watching

You can compose and send i-mode mail messages while you are watching a 1Seg program. (Multiwindow)

When you send an i-mode mail message to the FOMA phone supporting the "Media To" function by "Recom. channel mail", the receiving end can start 1Seg by using the "Media To" function.

- You cannot operate 1Seg while the Message Composition display is shown. You cannot display the caption and data broadcasting, either.
- You can compose SMS messages while watching a 1Seg program.



### 1 Viewer display FUNC Compose message ▶ Compose message or Recom. channel mail

#### Compose message

... You can compose a new i-mode mail message.  
Go to step 2 on page 174.

#### Recom. channel mail

... You can compose an i-mode mail message whose text contains the information of the channel you are watching.  
Go to step 2 on page 174.

- When the Message Composition display is shown, you can switch between the Message Composition display and the viewer display (horizontal display) each time you press and hold  for at least one second. When the viewer display is shown, you can change the display directions each time you press .

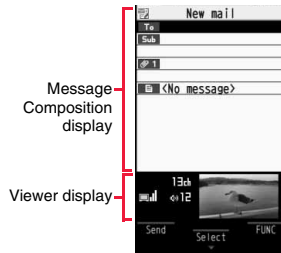

### Information

- Even when you show the Message Composition display/detailed Sent Mail display by Multitask while you are watching a 1Seg program, the display appears in the multiwindow.
- Only the audio is output from a 1Seg program without showing the viewer display if you select "Mail history" from the Function menu of the Inbox/Outbox/Draft list or a detailed mail display by Multitask while watching a 1Seg program and show the detailed Sent Mail display of a mail message sent to a person whose mail address is not stored in the Phonebook.
- When  appears, switch to the viewer display and then operate.
- In B Mode of 2in1, you cannot compose/send i-mode mail message. (See page 396)

## Receive i-mode Mail while Watching

When an i-mode mail message comes in from the person whose mail address is stored in the Phonebook, you can open the detailed Received Mail display while you are watching a 1Seg program. (Multiwindow)

- You cannot operate 1Seg while the detailed Received Mail display is shown. You cannot show the caption and data broadcasting, either.
- You can show an SMS message as well while watching a 1Seg program.

### 1 Receive i-mode mail while Viewer display is shown

#### ▶ Reception Result display ▶ Mail

#### ▶ Select an i-mode mail message to be displayed ▶ OK

- When the detailed Received Mail display is shown, you can switch between the detailed Mail display and the viewer display (horizontal display) each time you press and hold **[MENU]** for at least one second. When the viewer display is shown, you can change the display directions each time you press **[INFO]**.

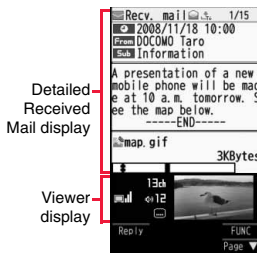

### Information

- Even when you show the detailed Received Mail display by Multitask while you are watching a 1Seg program, the display appears in the multiwindow.
- Only the audio is output from a 1Seg program without showing the viewer display when you show a mail message from the party whose mail address is not stored in the Phonebook.
- When the display is shown in multiple windows, or when only audio from a 1Seg program is played back with the detailed Received Mail display shown, you cannot press **[INFO]** to show other messages. However, you can press **[INFO]** to show other messages when you select "Mail history" from the Function menu of the Inbox/Outbox/Draft List or the detailed mail display by Multitask while watching a 1Seg program.
- When "**[INFO]**" appears, switch to viewer display and then operate.

## <Program Guide i-appli>

# Using Program Guide i-appli

By using the Program Guide i-appli, you can start 1Seg by selecting a program from the program guide, book programs, and set timer recordings. (See page 231)

### 1 **[MENU]** ▶ 1Seg ▶ Program guide

- Press **[MENU]** (**[TV起動]**) from the display of "Gガイド番組表リモコン" (G Guide Program List Remote-controller) to watch the program currently broadcast on the selected channel.
- For details, refer to "Mobile Phone User's Guide [i-mode] FOMA version".



### Information

- You can set the Program Guide i-appli by "Program guide key" of "Software setting".
- When you use "Gガイド番組表リモコン" (G Guide Program List Remote-controller) for the first time, you need to do initial settings.
- This software program is not available when the mode of 2in1 is set to B Mode.

## Using Data Broadcasting

1Seg enables you to use the data broadcasting in addition to the video and audio. Various information including still/moving images is available from the site linked with TV programs.

### 1 Viewer display (Video Mode)



Video Mode switches to Data Broadcasting Mode and “d” appears.

- Audio from a 1Seg program is output even during Data Broadcasting Mode.

- You can display only data broadcasting when you press (Full). Press (Change) to return to the former display.

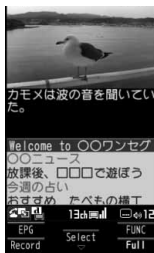

### 2 Select an item (link).

- The confirmation display appears asking whether to connect to i-mode depending on the data broadcasting and data broadcasting site.
- See page 151 for the operation while a site is displayed.

#### Information

- Each time you press , Video Mode and Data Broadcasting Mode are switched.
- You cannot display the data broadcasting on the horizontal display.
- You cannot enter pictographs when you enter characters on data broadcasting or data broadcasting site.
- Depending on the program, the audio might be output while the i-mode site is displayed. However, the 1Seg video is not displayed.
- Depending on the program, a tone might be output when you display the data broadcasting or data broadcasting site. In that case, the output of the 1Seg audio temporarily stops, and the tone of the data broadcasting is preferentially output.
- While the data broadcasting or data broadcasting site is displayed, the confirmation display might appear asking whether to send the contents you entered on the site or whether to permit obtaining mobile phone information.

#### Information

- When you select “YES (confirm once)” from the confirmation display for data broadcasting, the information on data broadcasting might be automatically updated, and you might be charged a packet communication fee. (See page 264)
- If you move in a place where the airwave is unstable while watching a 1Seg program, the video, data broadcasting, and data broadcasting site may be automatically updated. In that case, the top page of the data broadcasting appears, and the information you have entered into the connected data broadcasting or data broadcasting site is cleared. Ensure that you watch the data broadcasting and data broadcasting site in a place where the airwave is stable.

### Use Highlighted Information for Various Operations

You can use the highlighted information in the data broadcasting site to easily use the functions such as making calls, or sending mail. Select an item (link) and use the Phone To/AV Phone To or Mail To function. (See page 164)

#### Information

- Depending on the data broadcasting or data broadcasting site, the function of composing i-mode mail or storing the Phonebook entries might be automatically used. The confirmation display asking whether to use each function appears.

<TVlink>

## Using TV Links

Some data broadcasting programs might contain TV links which lead to the details of the programs or related information site.

From the TV links, you can store the site address information in the TVlink list and can easily call them up for browsing later.

### Store in TV Links

When you select the item (link) that can be stored in the TVlink list, the confirmation display appears asking whether to store it in the TVlink list. You can store up to 50 TV links.

#### 1 In Data Broadcasting Mode, select an item (link) that can be stored in the TVlink list ► YES

- When you try to store the same URL or memo information, the confirmation display appears asking whether to overwrite it.
- When the maximum number of TV links has already been stored in the TVlink list, the confirmation display appears asking whether to store after deleting.

### Information

- Validity period is set for some links.
- When a URL for a link contains more than 60 half-pitch characters, you cannot store the link.

### Bring Up a Stored TV Link

#### 1 ► 1Seg ► TVlink

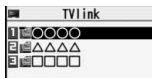

► Select a TV link to be displayed.

- When the confirmation display appears asking whether to connect to i-mode, select "YES".
- For a link whose validity period is expired, the confirmation display appears asking whether to delete it.



TVlink list

### Icons in the TVlink list

Icon	Format	Description
	Memo information	Displays memo information.
	Link communication contents	Connects to the data broadcasting site. (Video and caption are not displayed.)
	i-mode contents	Connects to the i-mode site.

### Function Menu of the TVlink List

Function menu	Operation/Explanation
Display detail	Displays the title, URL, outline, content type, and validity period of the TV link.
No. of TVlink	Displays the number of the registered TV links.
Delete this	► YES
Delete selected	► Put a check mark for TV links to be deleted ►  (Finish)
Delete all	► Enter your Terminal Security Code ► YES

## Recording a 1Seg Program while Watching

You can save the program as video or still images while you are watching.

- The copy control signals such as "Copy never", "Copy once", and "Copy free" are incorporated into 1Seg. The copy control signals are determined by each broadcasting station.
- You cannot record the programs of "Copy never". Further, when the copy control signal is changed to "Copy never" during recording, the recording session is closed, and the video recorded up to that point is saved.



## Record Video

The recorded video is saved to the microSD card (“Data box”→“1Seg”→“Video”→“microSD”).

- See page 296 for playing back the recorded video.
- You cannot save the recorded video to the FOMA phone.

### 1 Viewer display (for at least one second)

The confirmation tone sounds, “ REC ” appears, and recording starts.

- When the airwave reception level indicates “”, you cannot record video. Even if “” is indicated, you might not be able to record it depending on the airwave conditions.
- You cannot change the channel during recording.

### 2 Press .

The confirmation tone sounds and video is saved.

- When the file size is larger than 2 Gbytes, or the storage location becomes full, the recording automatically ends, and then the video recorded up to that point is saved.

#### ■ Estimate of the number of saved files and recordable time

The maximum savable number	99
The maximum recordable time (total)	Approx. 740 minutes

- The savable number of video files decreases depending on the data volume.
- The maximum recordable time is an estimate for microSD card of 2 Gbytes, and it is an estimate for 224 kbps of video, 48 kbps of audio, and 52 kbps of data (including captions). The recordable time varies depending on the broadcasting station or program.

#### Information

- The playing time of the saved data might become shorter than the recording time depending on the airwave conditions.
- The recording is not suspended even when you switch displays by Multitask or when a call comes in during recording.
- When the airwave conditions are changed to indicate “” during recording, recording continues but video and audio during that period are not saved.
- If you remove the battery pack or pull out the microSD card during recording, the recorded data is saved to the microSD card as the file that cannot be played back.
- Depending on the broadcasting station or program, video and audio might be saved a few seconds after your recording operation.

#### Information

- You cannot record when the video storage area is full. Also, you might not be able to record when the unused space in the storage area is not enough. Delete unnecessary video files and try again.
- Some programs cannot use the storage area fully.
- The file name and title name of the saved video are as follows:  
File name: “PRGXXX”  
Title name: “YYYY/MM/DD hh:mm”  
(X: numerals, Y: year, M: month, D: date, h: hour, m: minute)
- You cannot set the recorded video for the Stand-by display, ring tone or Call Receiving display.
- Data broad casting cannot be saved as video.

## Record Still Images

The recorded still images are saved to your FOMA phone (“Data box”→“1Seg”→“Image” folder). You can save up to 3,500 files in total sharing the memory space with other data files, however, the number of files you can save decreases depending on the data volume. (See page 474)

- See page 282 for displaying the recorded still image files.
- You cannot save still images to the microSD card.

### 1 Viewer display

The confirmation tone sounds, and the still image is saved.

- When the airwave reception level indicates “”, you cannot record still images.

#### Information

- The file name and title name of the saved still image are as follows:  
File name: “YYYYMMDDhhmmXXX”  
Title name: “YYYY/MM/DD hh:mm”  
(Y: year, M: month, D: date, h: hour, m: minute, X: numeral)
- You cannot set the recorded still image for the Stand-by display or the Call Receiving display.
- See page 163 for when images are stored to the maximum.
- Data broadcasting and caption cannot be saved as still images.



## Booking Programs or Setting Timer Recording of 1Seg

You can book programs or set timer recordings of 1Seg. At the specified date/time, an alarm sounds to notify you of the start of the program.

- You can book programs or set timer recordings also by using the channel information displayed in the Program Guide i-appli, sites, or mail.

### Book Program

You can book programs by setting the date/time, channel, and program name. You can book up to 100 programs.

1 1Seg > Book program > (New)

▶ Do the following operations.

- Select a booked program to check the contents, and you can edit it by pressing (Edit).

Item	Operation/Explanation
Start date setting	Enter a date/time for starting watching. ▶ Select an item. Enter date . . . . . Enter a date/time directly. Choose date . . . . . Select a date from the Calendar and enter a time.
Channel	▶ Select a channel.
Edit title	▶ Enter a program name. • You can enter up to 48 full-pitch/96 half-pitch characters.
Repeat	▶ Select a type of repeat. • If you select "Select day", put a check mark for days of the week to be set and press  (Finish). • The item set with repetition is counted as one item.

Item	Operation/Explanation
Alarm	▶ Select an alarm method. ON . . . . . Alerts you at the time set for the start date/time comes. The setting for alarm notification is completed. ON/Set time . . . Alerts you at the time set as the prenotification. OFF . . . . . Does not alert. The setting for alarm notification is completed. (You cannot watch the 1Seg program.) ▶ Select how many seconds (minutes) before the specified time to be alerted.
Alarm tone	▶ Select a type of alarm tone ▶ Select a folder ▶ Select an alarm tone.
Volume	▶ Use  to adjust the volume. • If you set to "Step", the alarm tone is silent for about three seconds, and then the volume steps up every about three seconds, from Level 1 through Level 6.
(Activate TV w/ alarm)	If you set to "ON", you can start 1Seg directly from the Booking Alarm Notification display. ▶ ON or OFF

2 Press (Finish).

## Timer Recording

You can set timer recordings by setting the date/time, channel, and program name. You can set up to 100 timer recordings.

1 1Seg ▶ Timer recording   
▶ Do the following operations.

- Select a set timer recording to check the contents, and you can edit it by pressing (Edit).
- You can display the used memory space (estimate) by pressing (Memory).

Item	Operation/Explanation
Start date setting	Enter a date/time for starting or ending recording. The booking alarm notification is made about one minute before the starting time.
End date setting	▶ Select an item. Enter date . . . . . Enter a date/time directly. Choose date . . . . . Select a date from the Calendar and enter a time.
Channel	▶ Select a channel.
Edit title	▶ Enter a program name. • You can enter up to 48 full-pitch/96 half-pitch characters.
Repeat	▶ Select a type of repeat. • If you select "Select day", put a check mark for days of the week to be set and press  (Finish). • The item set with repetition is counted as one item.
Alarm	You can set whether to make the alarm tone for the booking alarm notification. ▶ ON or OFF
Volume	▶ Use  to adjust the volume. • You cannot set the volume to "Stop".

Item	Operation/Explanation
Priority	You can set a recording operation for when the start date/time arrives while operating a function which cannot be started up simultaneously. ▶ Recording or Operation Recording . . . . . Suspends and terminates the function being operated, and starts recording. Operation . . . . . The confirmation display appears asking whether to start recording. Select "YES" to suspend and terminate the function being operated and start recording. <ul style="list-style-type: none"><li>• For while operating a function which can be started up simultaneously, recording starts by the Multitask function.</li><li>• When the start time arrives during a call (including dialing and ringing), recording starts after you end the call. When you are using another function during a call, recording starts after you end the call and the function.</li></ul>

2 Press (Finish).

- When the confirmation display appears asking whether to set the timer recording, select "YES". If you select "YES (confirm once)", the same confirmation display does not appear afterward.

### Information

- You can book programs or set timer recordings also by using the program information displayed in the Program Guide i-αppli, sites, or mail. In that case, the registration display might appear with the start date/time, end date/time, channel, and program name entered.
- When you booked multiple programs whose booking alarm notification is made at the same date/time, the notification for the program set for the earliest start date/time is preferentially made. When the start date/time of the programs is the same, the notification set for the program booked in the last is preferentially made.
- You cannot set multiple timer recordings whose recording time overlaps. If you set two timer recordings and the recording end time of one program is the same as the recording start time of the other, recording of the first program ends about one minute earlier.
- You cannot book programs or set timer recordings of which starting date/time or alarm notification date/time (for Timer Recording, about one minute before) is over except for the booking set to be repeated.

## Information

- The program bookings and timer recordings of which alarm notification date/time is over are automatically deleted. However, the bookings set to be repeated, program bookings for which "Alarm" is set to "OFF" are not deleted. Also the bookings are not deleted if you were operating the program booking/timer recording function on the notification date/time.
- When no channel lists are set, you cannot book programs and set timer recordings.
- When you have set "Priority" to "Operation" and the confirmation display is shown, the recording does not start even at the recording start time and starts at the time you select "YES". However, the recording is not executed if the recording end time is over.
- The title of the recorded video file takes the program name booked for the timer recording.
- "⊙ REC" appears on the viewer display during recording by Timer Recording.
- The audio from a 1Seg program is not output during recording started by Timer Recording. You can output the audio by pressing (CLR) or adjusting the sound volume, however.

## Function Menu while Book Program or Timer Recording is Displayed

Function menu	Operation/Explanation
<b>New</b>	Go to step 1 on page 259 for Book Program. Go to step 1 on page 260 for Timer Recording.
<b>Edit</b>	Go to step 1 on page 259 for Book Program. Go to step 1 on page 260 for Timer Recording.
<b>Sort</b>	You can change the display order. ▶ <b>Select an order.</b>
<b>Delete this</b>	▶ <b>YES</b>
<b>Delete past</b>	You can delete the program bookings and timer recordings whose start date/time or end date/time is set for the past date/time. ▶ <b>YES</b>
<b>Delete selected</b>	▶ <b>Put a check mark for program bookings or timer recordings to be deleted</b> ▶ (Finish) ▶ <b>YES</b>
<b>Delete all</b>	▶ <b>Enter your Terminal Security Code</b> ▶ <b>YES</b>
<b>Memory info</b>	You can display the used memory space (estimate). [Timer Recording only]

## When you set an alarm for "Book program" or "Timer recording"

The icon appears on the desktop.

"🔔". . . . Displayed when an alarm is set for today (except the setting for past time).

"🔔". . . . Displayed when an alarm is set for tomorrow or onward only.

- If you set "Alarm" to "OFF" for a program booking, the icons are not displayed.

## When the time specified for "Book program" or "Timer recording" comes

<Book Program>

The alarm sounds for about five minutes, and illumination lights. The vibrator works as the same setting for "Phone" of "Vibrator". The set start date/time, channel, program name and an animation appear on the display.

<Timer Recording>

About one minute before starting time, the alarm sounds for about two seconds, and illumination lights. The vibrator works as the same setting for "Phone" of "Vibrator". The set start date/time, end date/time, channel, program name and an animation appear on the display, then the viewer display appears.

To end recording started by Timer Recording to save video, press (MENU) from the viewer display and select "YES".

- During a call  
The alarm sounds from the earpiece.

- During operations

<Book Program>

When "Alarm setting" is set to "Operation preferred", the booking alarm notification is made only when the Stand-by display is shown. When it is set to "Alarm preferred", the booking alarm notification is made even while you are operating another function or during a call. (See page 364)

<Timer Recording>

Timer Recording works according to the setting of "Priority". (see page 260) However, Timer Recording might not work when you are reading to/writing from the microSD card, or accessing the Data Storage Center.

- When the booking alarm notification for a program booking or timer recording is set to the same time of "Alarm", "ToDo", or "Schedule"  
The notification is made in the priority order of "Alarm" → "Timer recording" → "ToDo" → "Schedule" → "Book program". A missed program booking or timer recording is notified by the icon on the desktop.

- When the power is turned off

The booking alarm notification is not made. For Timer Recording, you cannot record a 1Seg program unless the power has been set to "ON" one minute before the start date/time.

The icon does not appear on the desktop even after turning on the power.

- In Manner Mode

The vibrator, message display, and illumination light notify you. The alarm sounds at the volume set for Manner Mode. (See page 97)

- During Lock All, Personal Data Lock or Omakase Lock

The booking alarm notification is not made. You cannot record a 1Seg program unless each lock is released one minute before the start date/time.

After releasing each lock, the icon appears on the desktop to inform you.

- During infrared data exchange, during iC communication, or while SD-PIM is operated

The booking alarm notification is not made. You cannot record a 1Seg program unless each function is finished one minute before the start date/time.

After each function is finished, the icon appears on the desktop to inform you.

- While resetting settings or updating software program

The booking alarm notification is not made. You cannot record a 1Seg program unless setting reset or software update is finished one minute before the start date/time.

When the specified time comes during resetting settings, the icon does not appear on the desktop even after resetting settings is completed.

## Information

- When you book programs or timer recordings with "Alarm setting" set to "Alarm preferred", and the booking alarm time arrives while you are dialing, the alarm sounds after you have called up the other party. When booking alarm time arrives during ringing, the alarm sounds after communication has started.
- You might not be able to set some Chaku-uta Full® music files for an alarm for a program booking.
- When a Chaku-uta Full® music file is set for an alarm for a program booking, only the audio is output at the specified time. The illumination for when you play back a demo to select an alarm tone differs from for when you are notified by an alarm.

## To clear alarm tone/booking alarm message, and animation for Book Program

The alarm tone stops by pressing any of the keys, but the animation becomes a still image, and the booking alarm message stays displayed. When "Activate TV w/ alarm" is set to "OFF", press any key again to clear. However, you cannot clear the booking alarm message by pressing a side key, with the FOMA phone closed. When a call comes in, the alarm stops.



## When "Activate TV w/ alarm" of Book Program is set to "ON"

Press  (TV) and select "YES" from the Booking Alarm Notification display; then 1Seg starts, and you can watch the booked program. If you start watching the booked program during recording, the video recorded up to that point is automatically saved; then the booked program appears.

## When "Booking Alarm Notification" is not executed or recording is completed

The icon appears on the desktop. You can check that icon for the contents of the missed booking alarm (booking information) or recording result.

The booking information or recording result is the latest missed one.

- When "Activate TV w/ alarm" is set to "ON", you can start 1Seg also by pressing  (TV) and select "YES" from the display of booking Information.
- When recorded video is stored, you can play back the video also by pressing  (Play) from the display of recording result.

## Recording Result

You can display up to 20 recording results from the latest one.

**1**  **1Seg**  **Recording result**  
 **Select a recording result.**

- To delete all recording results, press  (DEL all), enter your Terminal Security Code, and select "YES".

Recording result	
1	2008/11/18 10:00
N	Drama
2	2008/11/18 08:00
N	Variety show
3	2008/11/18 07:00
N	News

## Settings for 1Seg

### 1 1Seg ► User settings ► Do the following operations.

Item	Operation/Explanation
<b>Caption</b>	You can set whether to display the caption for when watching starts. ► <b>ON or OFF</b>
<b>Rec. when low battery</b>	You can set whether to continue recording when the battery runs short during recording. ► <b>ON or OFF</b> <b>ON</b> . . . . The confirmation display does not appear and recording continues. <b>OFF</b> . . . . The confirmation display appears asking whether to end recording.
<b>Image quality</b>	You can change the image quality. ► <b>Select an item.</b> <b>Standard</b> . . . .The average image quality <b>Sports</b> . . . . .The image quality suitable for sports programs <b>Cinema</b> . . . . .The image quality suitable for movies <b>Dynamic</b> . . . . .The dynamic image quality by accentuation
<b>Sound (Auto volume)</b>	You can set whether to turn up the sound volume so that it will be more audible. ► <b>Sound effect ► Auto volume ► ON or OFF</b>
<b>Sound (Remaster)</b>	You can bring the sound from an earphone to the original sound by complementing high-pitch range lost at data compression. ► <b>Sound effect ► Remaster ► ON or OFF</b>

Item	Operation/Explanation
<b>Sound (Listening)</b>	You can set sound effect for listening. ► <b>Sound effect ► Listening ► Select an item.</b> <b>Surround</b> . . . . Makes the sound natural and stereophonic. <b>Natur 1/2</b> . . . . Complements the cooped-up feeling specific to earphones and plays back natural sound. Select 1 or 2 according to your taste. <b>OFF</b> . . . . . Sets Listening to "OFF". ● "Natur 1/2" is effective for the sound from an earphone.
<b>Sound (Equalizer)</b>	You can change the quality of the sound from an earphone. ► <b>Sound effect ► Equalizer ► Select an item.</b> <b>Normal</b> . . . . .Reproduces normal sound quality. <b>Dynamic</b> . . . . .Makes the sound dynamic by accentuation. <b>Voice</b> . . . . .Makes conversation audible. <b>Train</b> . . . . .Minimizes abnormal sound that causes sound leakage.
<b>Sound (TV sound while closed)</b>	You can set whether to continue outputting audio for when you close the FOMA phone while watching a 1Seg program. ► <b>TV sound while closed ► ON or OFF</b> ● When the setting is "OFF", audio is silenced when you close the FOMA phone. Audio is output again when you open the FOMA phone and select "OK".
<b>ECO mode</b>	You can set ECO Mode which fixes some settings and reduces the battery consumption. ► <b>YES</b> ● To release ECO Mode, perform the same operation. ● Once ECO Mode is set, the following settings are fixed and cannot be changed. However, if you release ECO Mode, settings return. Image quality: Standard Remaster: OFF Listening: OFF Equalizer: Normal

Item	Operation/Explanation
<b>Display light</b>	<p>You can set the period of time of the display lights while you are watching a 1Seg program.</p> <p>▶ <b>Constant light or Lighting duration</b></p> <p>▶ <b>Enter a lighting duration (minutes).</b></p> <p>● Enter from "01" through "30" in two digits.</p>
<b>Data broadcasting (Set image display)</b>	<p>You can set whether to display images of the data broadcasting site. (See page 165)</p>
<b>Data broadcasting (Sound effect setting)</b>	<p>You can set whether to sound an effect tone of the data broadcasting and the data broadcasting site.</p> <p>▶ <b>Sound effect setting ▶ ON or OFF</b></p>
<b>Data broadcasting (Reset settings)</b>	<p>If you select "YES (confirm once)" from the confirmation display for data broadcasting, the same confirmation display does not appear afterward. The confirmation display resumes after you execute Reset Settings.</p> <p>▶ <b>Reset settings ▶ YES</b></p>
<b>Icon</b>	<p>You can set whether to always display guide (see page 251) in the horizontal display.</p> <p>▶ <b>ON or OFF</b></p> <p>● Even if you set "Icon" to "OFF", the icon such as "☎", "✉", "☎" or "✉" appears during communication or when an i-mode mail message or Message R/F comes in.</p>
<b>Check TV settings</b>	<p>You can check each of "User settings".</p>
<b>Reset channel setting</b>	<p>You can delete all channel lists.</p> <p>▶ <b>Enter your Terminal Security Code ▶ YES</b></p>
<b>Reset storage area</b>	<p>▶ <b>(iR) (FUNC) ▶ Delete this or Delete all</b></p> <p><b>Delete this . . . .</b> Deletes only the information of the affiliated broadcasting stations you selected, from the broadcasting storage area.</p> <p><b>Delete all . . . .</b> Deletes the information of all affiliated broadcasting stations created in the broadcasting storage area.</p> <p>▶ <b>YES</b></p> <p>● If you select "Delete all", you need to enter your Terminal Security Code.</p>

Item	Operation/Explanation
<b>Reset TV settings</b>	<p>You can reset each of "User settings" to the default. See "Function List" for the items to be reset. (See page 422)</p> <p>▶ <b>Enter your Terminal Security Code ▶ YES</b></p>

### Information

#### <Sound (TV sound while closed)>

- When "TV sound while closed" is set to "ON", the information about the data broadcasting might be automatically updated, and you might be charged a packet communication fee.
- Regardless of the setting of this function, the audio is output even if your FOMA phone is closed when you switch displays by Multitask, or when the displays are shown in multiple windows.

#### <ECO mode>

- When you switch to the horizontal display from the vertical display in ECO Mode, the information about the data broadcasting is discarded. Switch to the vertical display to receive the data broadcasting again.

#### <Data broadcasting (Set image display)>

- If you change this setting, "Set image display" of "i-mode settings" is also changed.

#### <Data broadcasting (Reset settings)>

- You cannot reset the confirmation display at the start of 1Seg (see page 248) and at the time of Timer Recording (see page 260).

#### <Icon>

- The guide display might appear even if "Icon" is set to "OFF" when the airwave conditions have got worse.

# Full Browser/PC Movie

Displaying Web Pages Designed for PC . . . . . <Full Browser>	266
Setting Full Browser . . . . . <Full Browser Settings>	269
What is PC Movie? . . . . .	272
Downloading PC Movies . . . . .	272
Playing Back PC Movies from Data Box . . <PC Movie Player>	274

## Displaying Web Pages Designed for PC

You can browse Internet web pages designed for PCs using the Full Browser function. You can display even the Internet web pages that cannot be correctly displayed by i-mode. However, you cannot display or correctly display some Internet web pages.

- The data such as Home URL or Bookmarks registered via Full Browser cannot be used via i-mode. The contents set by Full Browser are invalid for i-mode, either.
- Note that you are charged a high communication fee for the massive data communication such as browsing Internet web pages having many images or downloading data files. For details on the packet communication fee, refer to "Mobile Phone User's Guide [i-mode] FOMA version".
- You can browse Internet web pages composed of frames. You can select a frame to display it as well. (See page 268)
- You can display SSL/TLS<sup>®</sup>-compatible pages via Full Browser.  
 ※SSL and TLS are the methods of safer data communication using authentication/ encryption technology to protect your privacy. SSL/TLS pages prevent eavesdropping and information alteration during communication by exchanging encrypted data files. Further, server authentication prevents web spoofing, thus making your personal information such as credit card number or postal address exchanged safer.

### 1 Full Browser ▶ Select an item.

- Home** . . . . . Displays an Internet web page set as Home URL.
- Bookmark** . . . . . Displays an Internet web page stored in Bookmark. (See page 156)
- Last URL** . . . . . Displays an Internet web page you viewed last time.
- Go to location** . . . . . Displays an Internet web page by entering a URL. (See "Displaying Internet Web Pages" on page 155)







#### Full Browser settings

- . . . . . Configures Full Browser settings. (See page 269)
- When "Access setting" is set to "No", the confirmation display appears asking whether to start Full Browser. Highlight "Yes" and select "OK" to switch setting of "Access setting", then Full Browser starts up.
- To end Full Browser, press  with an Internet web page displayed and select "YES".

#### Information

- It may take long to display some Internet web pages.
- You cannot use the following functions in Full Browser:
  - Phone To function
  - Screen memos
  - Flash movies
  - PDF files

### Full Browser Display

- 1 : Displaying in the multiwindow
- 2 : Window number/Number of windows
- 3 : During communication in another window
- 4 : During communication in another frame
- 5 : PC Mode
- 6 : Phone Mode
- 7 : Displaying an enlarged frame

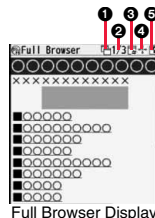



## Operations for the Full Browser display

Operation	Key operation	
	Phone Mode	PC Mode
Return to previous page	[Back] or [1]	[1]
Forward to next page	[Forward] or [3]	[3]
Scroll display	[Up/Down]	[Up/Down]
Scroll display page by page	[Up/Down] or [MENU] (Page [Up/Down])	[Up/Down] (Page [Up/Down])
	• To scroll to the top/end of the page, [Up/Down] (for at least one second), [MENU] (Page [Up/Down]) (for at least one second) or [X] / [#]	
Reload	[2]	
Enlarge/Reduce display size	[7] to reduce the display size, [8] to display in standard size, [9] to enlarge the display size	
Display Bookmark Folder list	[0]	

## Switch Display Mode

Two modes, “Phone mode” and “PC mode”, are available for the Full Browser display.

### 1 [i] [r] ▶ Full Browser ▶ Full Browser settings ▶ Display Mode setting ▶ Phone mode or PC mode

#### Phone mode

... Displays an Internet web page to fit in the display width of the FOMA phone. You do not need to scroll sideways; you can browse Internet web pages only by scrolling upward and downward.

#### PC mode

... Displays an Internet web page in the same format as when it is displayed on your personal computer in 800 (width) x 600 (height) dots. You can browse Internet web pages by scrolling upward, downward, and sideways.

- When you show an Internet web page, you can switch the display modes each time you select “Change disp. mode” from the Function menu.

## Use Operation Mode

Press [i] [r] (Open) from the Full Browser display to switch to “Operation mode”. The operation palette is displayed in Operation Mode, and you can move to the previous/next page or enlarge/reduce the display size.

[Back]: Moves to the previous/next page.

[Up/Down]: Enlarges/reduces the display size.

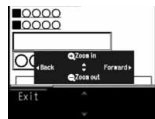

## Open in the Multiwindow

You can simultaneously open up to five Internet web pages via Full Browser.

- You can switch the simultaneously opened Internet web pages to show one by one.

### 1 Full Browser display ▶ [i] [r] (FUNC) ▶ Open new window ▶ Select an item.

- Bookmark** ... Opens a new window to show an Internet web page stored in Bookmark. (See page 156)
- Enter URL** ... Opens a new window to show an Internet web page by entering a URL. (See “Displaying Internet Web Pages” on page 155)
- Home** ... Opens a new window to show an Internet web page set as Home URL.
- Link** ... Opens a new window to show a page of the link highlighted on the Full Browser display.
  - See page 268 for how to switch or close the window.

## Information



- Some Internet web pages have links configured to open in new windows. When you open such a link, the new window opens even if you do not perform above operations.

## Display a Page Composed of Frames

You can display Internet web pages composed of frames. You can select a frame, and enlarge each selected frame for displaying.

### 1 From an Internet web page composed of frames

▶ Use  to highlight a frame, and press  (Select).

- In Phone Mode, highlight a frame by .
- To return to the display for all frames, press  or select "All frames" from the Function menu.

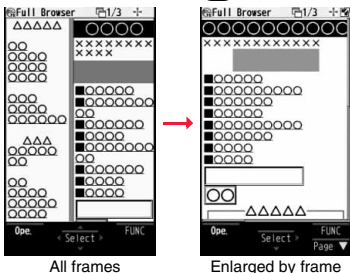

#### Information

- When an Internet web page has many divided frames, you might not be able to open all frames. "⊗" is added to the frames that you could not open.

## Switch from i-mode to Full Browser

You can switch to Full Browser to show the Internet web pages incorrectly displayed by i-mode.

### 1 While a page to be shown is displayed in Full Browser

▶  (FUNC) ▶ Internet ▶ Switch to FB ▶ OK

#### Information

- You cannot correctly display some Internet web pages.

## Function Menu of Full Browser Display

Function menu	Operation/Explanation
Add bookmark	See page 156.
Bookmark	See page 156.
Enter URL	You can enter a URL to display an Internet web page. ▶ <b>Select a text box.</b> Go to step 2 of "Displaying Internet Web Pages" on page 155. • The URL of the displayed site is entered beforehand.
Reload	The contents of the Internet web page is updated to the latest ones.
Change disp. mode	See page 267.
Open new window	See page 267.
Change window	You can switch the windows while displaying the Internet web pages in the multiwindow. ▶ <b>Select a window.</b>
Close window	You can close the window while displaying the Internet web pages in the multiwindow. ▶ <b>YES</b>
Save image	See page 160.
Add desktop icon	See page 109.
Compose message	You can compose an i-mode mail message with the URL of the displayed Internet web page pasted to the text. Go to step 2 on page 174.
Home (Set as home URL)	You can set the displayed Internet web page as Home URL. ▶ <b>Set as home URL</b> ▶ <b>YES</b>
Home (Display home)	You can display the Internet web page set as Home URL. ▶ <b>Display home</b>

Function menu	Operation/Explanation
<b>Scroll (Speed)</b>	See page 269.
<b>Scroll (Focus while scroll)</b>	See page 269.
<b>Zoom</b>	See page 270.
<b>All frames</b>	You can return to the display for all frames from the display for the enlarged frame.
<b>Retry</b>	You can play back the displayed animation from the beginning.
<b>Page info</b>	You can display information of the displayed Internet web page. ▶ <b>URL or Title</b>
<b>Others (Set image display)</b>	You can set whether to display images. ▶ <b>Set image display</b> See page 270.
<b>Others (Change CHR code)</b>	See page 153.
<b>Others (Cookie setting)</b>	You can set whether to validate cookies. ▶ <b>Cookie setting</b> Go to step 1 of "Cookie Setting" on page 271.
<b>Others (Delete Cookies)</b>	You can delete cookies. ▶ <b>Delete Cookies</b> Go to step 1 of "Delete Cookies" on page 271.
<b>Others (Referer setting)</b>	You can set whether to send a referer. ▶ <b>Referer setting</b> Go to step 1 of "Referer Setting" on page 271.
<b>Others (Certificate)</b>	See page 153.

### Information

#### <Compose message>

- The number of characters of the URL you can paste to the text is up to 512 half-pitch characters. If the URL contains 512 half-pitch characters or more, you cannot paste it.

### Upload Images

#### You can upload JPEG or GIF images stored in the FOMA phone to an Internet web page.

- Procedure for uploading images differs depending on the Internet web page. Follow the instructions on the display.

### Information

- When the total size of the selected images exceeds 80 Kbytes, you cannot upload the images.
- You may not be able to upload images depending on the Internet web page.
- You cannot upload the images whose output from FOMA phone is prohibited.

### <Full Browser Settings>

## Setting Full Browser

-  ▶ **Full Browser** ▶ **Full Browser settings**  
▶ Do the following operations.

Item	Operation/Explanation
<b>Display Mode setting</b>	See page 267.
<b>Scroll (Speed)</b>	You can set scroll speed. ▶ <b>Speed</b> ▶ <b>High speed or Low speed</b>
<b>Scroll (Focus while scroll)</b>	You can set whether to highlight links while scrolling. ▶ <b>Focus while scroll</b> ▶ <b>ON or OFF</b>

Item	Operation/Explanation
<b>Zoom</b>	<p>You can set the display size of the Internet web page. From the Function menu of the Full Browser display, you can enlarge/reduce the display size by each page.</p> <p>▶ <b>Select a display size.</b></p> <ul style="list-style-type: none"> <li>● In PC Mode, you can select a display area by "Select disp. area" from the Function menu of the Full Browser display.</li> </ul>
<b>Access setting</b>	<p>You can set whether to use Full Browser.</p> <p><b>Yes</b> . . . Uses Full Browser.</p> <p><b>No</b> . . . Displays the cautions at the start of Full Browser. Check the cautions, highlight "Yes" and then select "OK", then the setting switches to "Yes", and Full Browser becomes available.</p>
<b>Home URL</b>	<p>You can set Home URL.</p> <p>▶ <b>Select the URL field</b> ▶ <b>Enter a URL</b> ▶ <b>OK</b></p>
<b>Set image display</b>	<p>You can set whether to display images.</p> <p>▶ <b>ON or OFF</b></p>
<b>PC Movie auto-play</b>	<p>You can set whether to automatically play back the downloaded type of PC movies while obtaining.</p> <p>▶ <b>ON or OFF</b></p>
<b>Cookie setting</b>	See page 271.
<b>Delete Cookies</b>	See page 271.
<b>Referer setting</b>	See page 271.
<b>Script setting</b>	<p>You can set whether to validate JavaScript. JavaScript is a simple program language that runs on Internet web pages. It is widely used to create Internet web pages with movements.</p> <p>When "Valid" is set, you can use the JavaScript function to browse Internet web pages in Full Browser.</p> <p>▶ <b>Valid or Invalid</b></p>



Item	Operation/Explanation
<b>Window Open Guard</b>	<p>You can set whether to prevent a new window from opening automatically by JavaScript.</p> <p>▶ <b>Valid or Invalid</b></p>
<b>Check settings</b>	You can check respective Full Browser settings.
<b>Reset last URL</b>	<p>You can erase the URL of the Internet web page you viewed last.</p> <p>▶ <b>YES</b></p>

### Information

#### <Access setting>

- If you replace the UIM with a new one when "Yes" is set, the setting switches to "No".

#### <Set image display>

- Even when "ON" is set, images might not be displayed correctly. In this case, "  " is displayed.
- When "OFF" is set, "  " is displayed and the data file is not received.

#### <Script setting>

- Some Internet web pages may not be displayed correctly unless "Valid" is set.
- Even when "Valid" is set, it might not work depending on JavaScript.

## Cookie

By using cookies, you can effectively access the Internet web pages you have accessed once.

A cookie is the system to temporarily save personal information such as the date/time or number of times you accessed an Internet web page. The information from the server is written into the FOMA phone, temporarily saved, and used for content services.

- If a cookie is sent, the information such as the date/time or number of times you accessed an Internet web page is also sent to the web page. Note that even if your information is detected by a third party by sending a cookie, we cannot be held responsible for that. However, you may not be able to correctly display or use some Internet web pages or content services unless the cookie setting is valid.

### Cookie Setting

You can set whether to validate cookies.

- 1  **Full Browser** ▶ **Full Browser settings**  
▶ **Cookie setting** ▶ **Select an item.**

**Valid.** . . . . . Always validates cookies. The confirmation display does not appear before a cookie is sent or received.

**Invalid** . . . . . Always invalidates cookies.

**Notify(sending)** . . . . . Validates cookie's sending/receiving. The confirmation display appears each time a cookie is sent.

**Notify(receiving)** . . . . . Validates cookie's sending/receiving. The confirmation display appears each time a cookie is received.

**Notify(send/recv.)**  
. . . . . The confirmation display appears asking whether to permit a cookie to be sent or received each time a cookie is sent or received.

- When you replace your UIM with another one, "Invalid" is set. If you change the setting with replacing one inserted, the display for entering your Terminal Security Code might appear.

### Information

- When "Notify" is set, the confirmation display might consecutively appear asking whether to send/receive (update) cookies depending on the Internet web page.

### Delete Cookies

- 1  **Full Browser** ▶ **Full Browser settings**  
▶ **Delete Cookies** ▶ **Enter your Terminal Security Code**  
▶ **YES**

## Referer

The referer denotes the link source information. When a referer is sent, the information about from which page you have accessed it is sent to the site.

Note that even if your information is detected by a third party by sending a referer, we cannot be held responsible for that.

### Referer Setting

You can set whether to send a referer while an Internet web page is open.

- 1  **Full Browser** ▶ **Full Browser settings**  
▶ **Referer setting** ▶ **Select an item.**

**Send.** . . . . . Sends a referer.

**Unsend** . . . . . Does not send a referer.

**Notify** . . . . . When a referer is sent, the confirmation display appears asking whether to send it.

### Information

- When "Notify" is set, the confirmation display might consecutively appear asking whether to send a referer depending on the Internet web page.

## What is PC Movie?

By using high speed communication, you can play back smooth and high-quality PC movies provided by portal sites, movie specialty sites and other sites on the Internet.

- PC Movie Player supports playback of Windows Media® Video.
- When downloading or streaming a PC movie, you might receive a bulky size of file.  
Note that you are charged a high packet communication fee for a bulky sent/received file such as a streaming type file whose size is not limited. For the details of the packet communication fee and billing plan, refer to "Mobile Phone User's Guide [i-mode] FOMA version".

Categories		Description
Type	Playback type	
<b>Streaming type (cannot be saved)</b>	Plays back while obtaining	You can play back a PC movie while obtaining it. A long time playback is available.
<b>Download type (can be saved)</b>	Plays back while obtaining	When "PC Movie auto-play" is set to "ON", you can play back a PC movie while obtaining it. You can save it to the microSD card after download and play it back without re-connection. Up to 10 Mbytes of a file can be downloaded.
	Plays back a file saved to the microSD card	To the microSD card, you can save not only data files obtained by the FOMA phone but also PC movies obtained or created on a personal computer, and then play them back. You can save a bulky file of up to the space size of microSD card.

- The distribution server for streaming type supports Windows Media Services 9 only. You cannot play back a streaming type of PC movie distributed from other than Windows Media Services 9.
- Some sites check the operating environment (browser type, OS type, etc.) are checked and you might not be able to play back PC movies.
- See page 275 for the supported file format of PC movies.

## Downloading PC Movies

### Playing Back a Streaming Type of PC Movie

#### 1 Select a PC movie from a PC movie obtainable site▶YES

See page 274 for the operation during playback.



#### About license (Windows Media DRM)

- Among the PC movies protected by the license, you can play back the streaming type of PC movies only. You cannot play back the download type of PC movies protected by the license.
- You might not be able to play back PC movies depending on the license setting of the PC movies.
- If files are stored to the maximum when you try to obtain a license to save it to the FOMA phone, the confirmation display appears asking whether to delete currently stored licenses to save a new one. Select "YES" to delete all the stored licenses to save it. You need to obtain a license again to play back a PC movie whose license is deleted.

## Playing Back a Download Type of PC Movie

### 1 Select a PC movie from a PC movie obtainable site▶YES

See page 274 for the operation during playback.

- If "PC Movie auto-play" is set to "ON", a PC movie is played back during obtaining. If "OFF" is set, you can play it back by selecting "Play" from the Obtaining Completion display.
- When you obtain a download type of PC movie from a site, the file is obtained while it is played back, and obtaining itself continues even when you suspend the playback midway.







Obtaining Completion display

### When obtaining a PC movie is suspended



Depending on the type of a PC movie being obtained or the reason why the obtaining is suspended, the operation differs.



#### Streaming type

After the suspension by an incoming call, alarm notification, or disconnection of communication, the obtaining will be in pause state. Press   to resume playback from the suspended point.

The display before playback returns when you suspend obtaining by pressing  or .

#### Download type

After the suspension by an incoming call, alarm notification, or disconnection of communication, the Obtaining Completion display appears. However, when it is played back while obtaining, the display in pause state appears. Select "Play" to play back the obtained segments of the file. Select "ResumeDL" to resume obtaining from the suspended point. The confirmation display appears asking whether to discard the data when you suspend obtaining by pressing  or .

- For download type of PC movies, the downloading is continued during suspension if it is suspended by an incoming voice call, receiving a mail message or Message R/F, or alarm notification.
- Depending on the PC movie or the site you are connecting to, you cannot resume from the suspended point even by pressing   or selecting "ResumeDL". In that case, the obtaining resumes from the top of the file.



## Information

- Note that there is no upper size limit for a streaming type of PC movie, you might exchange the files of no size limit. When obtaining it, the confirmation display appears asking whether to play it back.
- Depending on the site or PC movie you are connecting to, you might not be able to obtain a file, play it back during obtaining, or play it back after obtaining.
- Depending on the line speed, line state, or radio wave conditions, the playback during obtaining might be suspended or the images might blur. You can repeatedly play back the download type of PC movies after obtaining but cannot play back the streaming type of PC movies.
- If the PC movie has the restrictions on the playable period, you cannot play it back before and after that period. If you leave your FOMA phone with the battery pack removed for a long time, the date/time information retained in the FOMA phone might be reset. In that case, you cannot play back the PC movie that has the restrictions on the playable period or playable deadline. See "Contents info" for checking the playback restrictions.
- If you try to play back a PC movie with a low battery, the battery alert tone sounds regardless of the setting of "Keypad sound", and the confirmation display appears asking whether to play it back. When the battery becomes low during playback, the playback pauses, and the confirmation display appears asking whether to end the playback.
- "Contents info" of a PC movie and deadline information on the display that notifies you of a playable deadline are shown by the date/time with "Summer time" set to "OFF".

## Saving PC Movies

You can save the obtained PC movies to the microSD card. However, you cannot save the streaming type of PC movies.

### 1 Obtaining Completion display▶Save▶YES

The PC movie is saved to the folder selected by "Select storage".

- When the maximum number of files has already been saved to the microSD card or memory space is full, the confirmation display appears asking whether to delete unnecessary files to save new one. Select "YES" and select unnecessary files from the displayed list in Data Box to delete them. Before deleting, you can play back PC movies on the microSD card for confirmation, but cannot display the previous or next files.

## Information

- You cannot attach the saved PC movie to an i-mode mail message for sending.

## Playing Back PC Movies from Data Box

You can play back moving images published on the Internet for personal computers or PC movies saved to the microSD card via a personal computer, etc.

**1** MENU ▶ Data box ▶ PC Movie

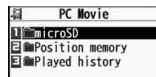

PC Movie Type Selection display

**2** microSD ▶ Select a folder ▶ Select a file.

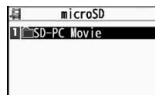

PC Movie Folder list



PC Movie list

### Operations while playing back a PC movie

• See page 277 for when you operate from the Function menu.

Operation	Key operation
Pause <sup>※1</sup>	 •   to play back
Fast forward <sup>※1</sup>	 •   to play back
Display next file <sup>※2※3</sup>	
Display previous file <sup>※2※3</sup>	<sup>※4</sup>
Select position to play <sup>※1※5</sup>	Press and hold
Sound volume adjustment	or

Operation	Key operation
Mute	 •   or adjust the sound volume to play back sound
Switch vertical display/ horizontal display <sup>※6※7</sup>	(Wide) • Each time of pressing switches display directions.
Remaster	 • Each time of pressing switches between "ON" and "OFF".
Listening	 • Each time of pressing switches in order of "OFF" → "Surround" → "Natur1" → "Natur2".
Equalizer	 • Each time of pressing switches in order of "Normal" → "S-XBS1" → "S-XBS2" → "Train".

※1 You might not be able to operate this for some PC movies.

※2 You cannot operate this for a streaming type of PC movie, or when you are playing back a PC movie while obtaining it. You cannot operate this when you play back an obtained but unsaved PC movie from the Obtaining Completion display, either.

※3 The files are displayed in the order on the PC Movie list. You can operate this when you play back from the PC Movie list. However, PC movies in WVX, ASX, and WAX formats are skipped.

※4 When three seconds have elapsed after starting playback, you go back to the beginning of the file. However, you might not be able to operate this for a streaming type of PC movie or when you are playing back a PC movie while obtaining it.

※5 You cannot operate this during fast-rewinding.

※6 The horizontal playback is valid during playback only. When you close the playback display, the vertical display returns.

※7 You cannot operate this for PC movies with incompatible video data or voice-only PC movies.

• If you play back on the horizontal display from the pause state, the display might become dark, however, the video appears soon after you resume the playback.



You can perform the following operations when you play back or pause a PC movie using the switch of Flat-plug Stereo Earphone Set (option) or Flat-plug Earphone/Microphone with Switch (option).

Operation	Switch operation
Pause	Press once. ● To play back, press again.
Play back next file	Press twice in succession.
Play back previous file	Press three times in succession. ● When playback time is over three seconds, you go back to the beginning of the file.

#### ■ Specification for PC movie playback

File format	WMV, WMA, WVX, WAX, ASF, ASX	
Extension	wmv, wma, wvx, wax, asf, asx	
Codec	Video	Windows® Media Video 8 through 9
	Audio	Windows® Media Audio 2 through 9
Bit rate	Video only	512 kbps
	Voice only	192 kbps
	Video + Voice	512 kbps + 64 kbps
Video size	QVGA (sidewise 320 dots x lengthwise 240 dots)	
Frame rate	30 fps	

You might be able to play back the files that exceed the bit rates described above.

- Even when the file format is supported, you might not be able to obtain files, play back during obtaining, or play back after obtaining depending on the file.
- If the file format of either video or audio is not supported, the file of the supported format only might be output.

#### Information

- Files with the extension of wvx, wax, asx are the files for which the URL of a PC movie on the Internet is specified. When you select those files saved on the microSD card, streaming or downloading playback starts from the specified URL.

#### ■ Icons on the PC Movie list

Icon	File format
	WMV, ASF
	WVX, ASX
	WMA
	WAX

Icon	Description
	PC movie on the Internet
	PC movie saved to the microSD card

- Above icons are displayed only for “Position memory” or “Played history”.

#### When you select “Position memory” from the PC Movie Type Selection display

The Position Memory Selection display appears. When you select “Marker to resume” or “Position memory1 through 9”, the PC movie is played back from the stored position.

Marker to resume	This is stored automatically when a call comes in, an alarm operates, or the battery level goes flat during playback of a PC movie, or when you terminate the PC Movie player during playback.
Position memory	You can store in any optional position in a PC movie, and create up to nine position memories. (See page 276 and page 277)

- You can display information about the position memory by pressing (FUNC) and selecting “Posit. memory info”.
- To delete “Position memory”, press (FUNC) and select “Multiple-choice”, “Delete this”, or “Delete all”. You cannot delete “Marker to resume”.
- When a PC movie with a position memory has been deleted or moved to another folder, or when its file name has been edited, you cannot play it back.
- Even when you play back a PC movie from a position memory, it may be played back from the beginning, depending on the PC movie.

## When you select “Played history” from the PC Movie Type Selection display

When you play back a PC movie, the URL or storage location of that file is stored as a history. Up to 30 histories are stored, and when those are exceeded, the oldest history is overwritten. Select a played history to play back the PC movie according to the history information.



- When a PC movie stored in a played history has been deleted or moved to another folder, you cannot play it back.
- When you play back an obtained but unsaved PC movie from the Obtaining Completion display, it is not stored in Played History.

## Function Menu of the PC Movie Folder List

Function menu	Operation/Explanation
<b>Add folder</b>	▶ <b>Enter a folder name.</b> • You can enter up to 31 full-pitch/63 half-pitch characters.
<b>Edit folder name</b>	▶ <b>Enter a folder name.</b> • You can enter up to 31 full-pitch/63 half-pitch characters.
<b>Delete folder</b>	▶ <b>Enter your Terminal Security Code</b> ▶ <b>YES</b>
<b>Select storage</b>	You can set a destination folder for saving downloaded PC movies to the microSD card. ▶ <b>YES</b>

### Information

<Select storage>

- “” is displayed for the folder set as a destination folder.

## Function Menu of the PC Movie List/Played History List

Function menu	Operation/Explanation
<b>Contents info</b>	You can display the file title, file name, and others of the PC movie.
<b>Move</b>	You can move the PC movie to another folder. ▶ <b>Select a destination folder.</b>

Function menu	Operation/Explanation
<b>Edit title (Edit title)</b>	▶ <b>Edit title</b> ▶ <b>Enter a title.</b> • You can enter up to 18 full-pitch/36 half-pitch characters.
<b>Edit title (Reset title)</b>	You can reset the title to the default. ▶ <b>Reset title</b> ▶ <b>YES</b>
<b>Copy</b>	You can copy the PC movie to another folder. ▶ <b>Select a destination folder.</b>
<b>History info</b>	You can display information of the played history.
<b>Position memory</b>	You can store the URL information of the PC movie stored in Played History to a position memory. When you play back the file from the position memory, it is played back from the beginning. ▶ <b>Select a position memory number to be registered.</b> • You cannot select “Marker to resume”.
<b>Multiple-choice</b>	You can select multiple files and operate them. ▶ <b>Put a check mark for files to be operated</b> ▶  (FUNC) ▶ <b>Select an item.</b> <b>Delete</b> . . . . .See “Delete this” on page 276. <b>Copy</b> . . . . .See page 276. <b>Move</b> . . . . .See page 276.
<b>Description</b>	You can display the lyric or description of the PC movie. ▶ <b>The words view or Description view</b> • Up to 1,024 full-pitch/2,048 half-pitch characters can be displayed in each.
<b>Memory info</b>	You can display the used memory space (estimate).
<b>Delete this</b>	▶ <b>YES</b>
<b>Delete all</b>	You can delete all the files in the folder. ▶ <b>Enter your Terminal Security Code</b> ▶ <b>YES</b>
<b>Listing</b>	You can change the display format of PC Movie list. ▶ <b>Title or File name</b>

## Function Menu during Pause/at the End of Playback

Function menu	Operation/Explanation
<b>Fast</b>	The PC movie is played back fast. <ul style="list-style-type: none"> <li>● To cancel it, press  .</li> </ul>
<b>Rewind</b>	The PC movie is played back fast in the opposite direction. <ul style="list-style-type: none"> <li>● To cancel it, press  .</li> </ul>
<b>Stop</b>	You can end playback.
<b>Position to play</b>	You can set the start position for playing back the PC movie. <ul style="list-style-type: none"> <li>▶ Use  to move the cursor position of the time bar and press  .</li> <li>● To cancel, press .</li> </ul>
<b>Sound effect (Remaster)</b>	You can bring the sound from an earphone to the original sound by complementing high-pitch range lost at data compression. <ul style="list-style-type: none"> <li>▶ <b>Remaster</b> ▶ <b>ON or OFF</b></li> </ul>
<b>Sound effect (Listening)</b>	You can set sound effect for listening. <ul style="list-style-type: none"> <li>▶ <b>Listening</b> ▶ <b>Select an item.</b></li> <li><b>Surround</b> . . . Makes the sound natural and stereophonic.</li> <li><b>Natur 1/2</b> . . . Complements the cooped-up feeling specific to earphones and plays back natural sound. Select 1 or 2 according to your taste.</li> <li><b>OFF</b> . . . . . Sets Listening to "OFF".</li> <li>● "Natur 1/2" is effective for the sound from an earphone.</li> </ul>
<b>Sound effect (Equalizer)</b>	You can change the quality of the sound from an earphone. <ul style="list-style-type: none"> <li>▶ <b>Equalizer</b> ▶ <b>Select an item.</b></li> <li><b>Normal</b> . . . Reproduces normal sound quality.</li> <li><b>S-XBS1</b> . . . Enhances bass sound.</li> <li><b>S-XBS2</b> . . . Enhances bass sound more deeply than S-XBS1.</li> <li><b>Train</b> . . . . Minimizes abnormal sound that causes sound leakage.</li> </ul>
<b>Contents info</b>	See page 276.

Function menu	Operation/Explanation
<b>Position memory</b>	You can store a position memory in the PC movie. Operate at the desired position in pause state. <ul style="list-style-type: none"> <li>▶ <b>Select a position memory number to be stored.</b></li> <li>● You cannot select "Marker to resume".</li> </ul>
<b>Description</b>	See page 276.
<b>Copy URL</b>	While playing back a PC movie published on the Internet, you can copy the URL of that PC movie. <ul style="list-style-type: none"> <li>● You can copy up to 512 half-pitch characters for the URL.</li> </ul>
<b>Display size</b>	You can set whether to display the PC movie in the original size (Actual size) or to fit it to the display size. <ul style="list-style-type: none"> <li>▶ <b>Actual size or Fit in display</b></li> <li>● Even if you set to "Actual size", the PC movie in excess of the display size is reduced to the display size.</li> </ul>

### Information

#### <Position to play>

- Depending on the PC movie, you might not be able to select the position to play.

#### <Sound effect>

- Even if an earphone is not connected, the respective setting contents are displayed on the display.

#### <Position memory>

- Depending on the PC movie, the top position might be stored as the playback start position regardless of the position where you pause.

#### <Display size>

- Depending on the image size, the image might be displayed with the right or bottom side cut off.

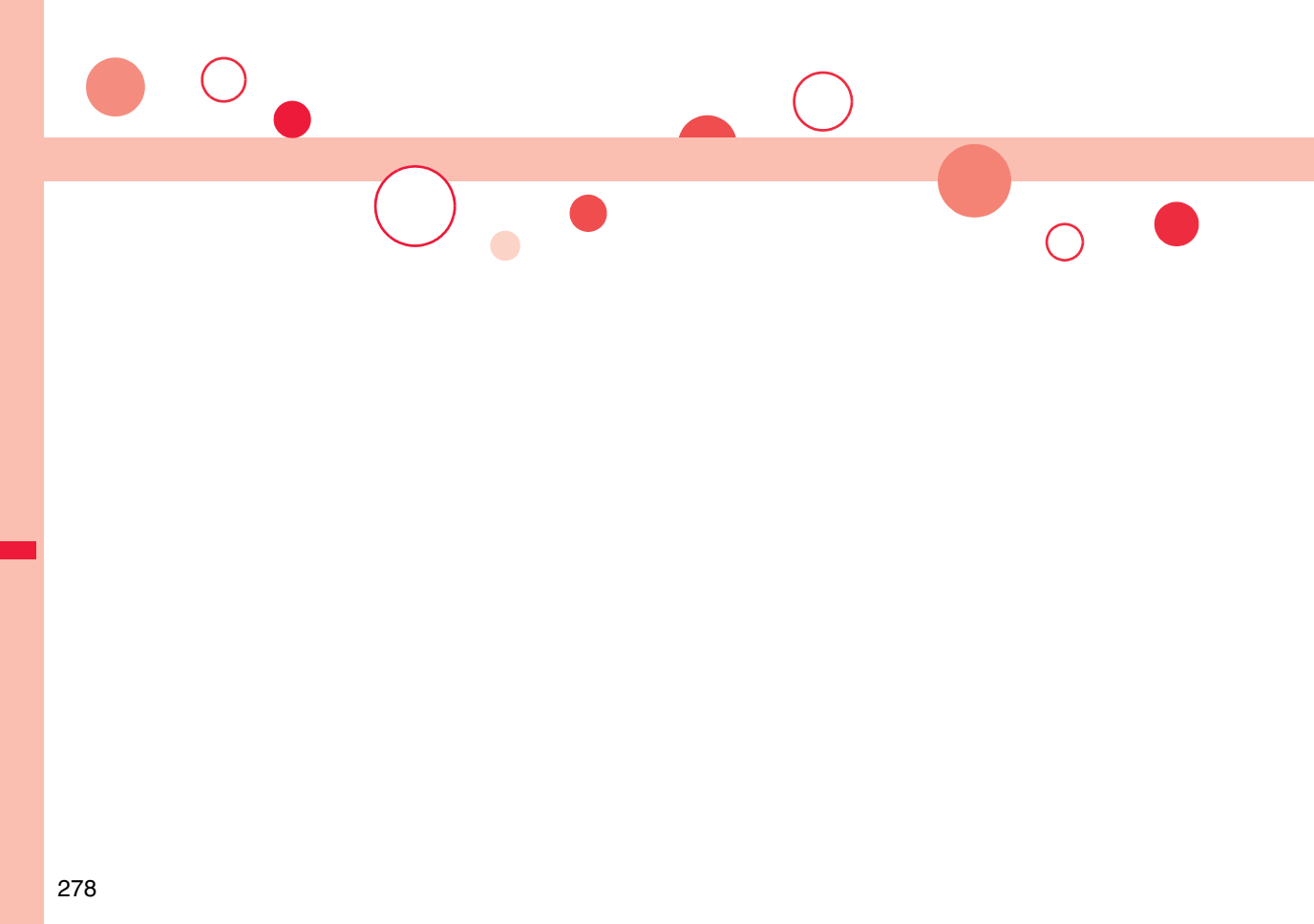

# Data Display/Edit/Management

About Data Box.....	280	Checking microSD Card .....	<Check microSD>	313
<b>Making Full Use of Still Images</b>		Displaying Capacity of microSD Card .....	<microSD Info>	313
Displaying Images .....	<Picture Viewer>	Using a microSD Card with a Personal Computer .....		313
Editing Still Images.....	<Edit Picture>	Folder Configuration on microSD Card .....		314
Creating Animations.....	<Original Animation>	<b>Making Full Use of Data</b>		
<b>Making Full Use of Moving Images</b>		Managing Folders .....		316
Playing Back Moving Images/i-motion Movies		<b>Making Full Use of Infrared Data Exchange</b>		
.....	<i-motion Player>	About Infrared Data Exchange .....		317
Using Playlist .....		Sending/Receiving One or Multiple Data Files .....		319
Editing Moving Images/i-motion Movies .....	<Edit i motion>	Sending/Receiving All Data Files .....		320
<b>Making Full Use of Video</b>		Using Infrared Remote-controller Function.....		321
Playing Back Video.....	<Video Player>	Communication Setting.....	<Forwarding Image>	321
<b>Making Full Use of Chara-den</b>		<b>Making Full Use of iC Communication</b>		
What is Chara-den? .....	<Chara-den>	About iC Communication .....	<iC Transmission>	321
Displaying/Operating Chara-den Images		Sending/Receiving One Data File.....		321
.....	<Chara-den Player>	Sending/Receiving All Data Files .....		322
Recording Chara-den Images .....	<Record Chara-den>	<b>Making Full Use of Voice Recorder</b>		
<b>Making Full Use of Melodies</b>		Using Voice Recorder .....	<Voice Recorder>	322
Playing Back Melodies.....	<Melody Player>	<b>Making Full Use of PDF Viewer</b>		
<b>Making Full Use of Kisekae Tool</b>		Displaying PDF Files .....	<PDF Viewer>	323
Checking Kisekae Tool .....	<Kisekae Tool>	<b>Making Full Use of Document Viewer</b>		
<b>Making Full Use of microSD Card</b>		Displaying Word, Excel, and PowerPoint Files		
About microSD Card .....	305	.....	<Document Viewer>	327
Inserting/Removing microSD Card .....	305	<b>Printing Still Images</b>		
Displaying Data Items on microSD Card .....	<SD-PIM>	Printing Saved Images .....		329
Copying Still Images, Moving Images, etc. ....	309			
Moving Copyrighted Files .....	<Movable Contents>			
Managing Unsupported Files .....	<SD Other Files>			
Formatting microSD Card .....	<microSD Format>			

## About Data Box

Data Box contains the items and folders as listed below. Data is saved to respective folders according to the contents.

My picture	
i-mode	Downloaded still images, etc.
Search by i-mode	Connects to the data site.
Camera	Still images shot by the camera, shot Chara-den images, etc.
Decomail-picture	Still images to be used for composing Deco-mail
Search by i-mode	Connects to the data site.
Decomail-pictograph	<p>お気に入り (Favorite)*1 Pictographs to be used for composing Deco-mail</p> <p>お絵文字 (Pictograph)*1 ● You can delete the pre-installed Deco-mail pictographs. You can re-download them from the "P-SQUARE" site (see page 164). When you use a UIM other than the one used for downloading, the UIM security function (see page 37) is set for them.</p> <p>装飾 (Decoration)*1</p> <p>ハート・キラキラ (Heart/Sparkling)*1</p> <p>天気・季節 (Weather/Season)*1</p> <p>移動・生活 (Transfer/Life)*1</p> <p>電話・メール (Phone/Mail)*1</p> <p>食べ物 (Food)*1</p> <p>キャラクター (Cartoon character)*1</p> <p>文字 (Character)*1</p> <p>Search by i-mode</p>
Pre-installed	Pre-installed still images
User folder**2	Still images in the user folder
Original animation	The function of displaying still images continuously
Frame	Still images to be used for frames
Stamp	Still images to be used for marker stamps and cushy marks
Search by i-mode	Connects to the data site.
microSD	Picture
	Still images shot by the camera, and images in JPEG format and GIF format that conform to the DCF standard and were copied from the FOMA phone
	Image Box
	Animation images in GIF format copied from the FOMA phone, and images in JPEG format that do not conform to the DCF standard
	Movable contents
	Copyrighted still images moved from the FOMA phone
	Decomail-pictograph
	Deco-mail pictographs copied from the FOMA phone

MUSIC		
i-mode	Initial folder	Chaku-uta Full® music files obtained from sites
	Search by i-mode	Connects to the data site.
	User folder**2	Chaku-uta Full® music files in the user folder
	Search by i-mode	Connects to the data site.
	microSD	Copyrighted Chaku-uta Full® music files downloaded or moved from the FOMA phone
WMA		WMA files obtained from personal computer
Music&Video Channel		
Downloaded program		Programs downloaded via Music&Video Channel
Saved program		Programs saved to the FOMA phone
motion		
i-mode		i-motion movies obtained from sites, etc.
Search by i-mode		Connects to the data site.
Camera		i-motion movies recorded by the camera, shot Chara-den movies, etc.
Pre-installed		Pre-installed i-motion movies
Voice recorder		Voices recorded by the voice recorder
User folder**2		i-motion movies in the user folder
Playlist		Playback of playlist
Position memory		Playback of marker position
Search by i-mode		Connects to the data site.
microSD	Movie	Moving images shot by the camera or copied from the FOMA phone
	Movable contents	Copyrighted moving images moved from the FOMA phone
	Other contents	Voice-only i-motion movies**3 recorded by using the camera function, voice-only i-motion movies**3 copied from the FOMA phone, or video-unplayable i-motion movies**3 copied from the FOMA phone
Melody		
i-mode		Downloaded melodies, etc.
Search by i-mode		Connects to the data site.
Pre-installed		Pre-installed melodies
User folder**2		Melodies in the user folder
Voice announce		Data files recorded by using "Voice announce"

Playlist	Playback of playlist	
Search by i-mode	Connects to the data site.	
microSD	Melody	Melodies copied from the FOMA phone
	Movable contents	Copyrighted melodies moved from the FOMA phone
<b>My documents</b>		
i-mode	Downloaded PDF files, etc.	
microSD	PDF files downloaded or copied from the FOMA phone	
<b>Kisekae Tool</b>		
Search by i-mode	Connects to the data site.	
microSD	Kisekae Tool files downloaded, or moved from the FOMA phone	
<b>Chara-den</b>		
Pre-installed or downloaded Chara-den images		
<b>PC Movie</b>		
microSD	PC movies downloaded, or saved by personal computer	
Position memory	Playback of marker position	
Played history	Playback histories of PC movies	
<b>1Seg</b>		
Image	Still images recorded by 1Seg	
Video	microSD	Video recorded by 1Seg, and copyright-protected and 1Seg compatible moving images made with other AV devices
	Position memory	Playback of marker position
<b>Document viewer</b>		
Document files saved from mail (attached files)		
<b>SD other files</b>		
SD others	Incompatible files saved from mail (attached files), or files in BMP or PNG format obtained by Full Browser	

※1 The folder names can be changed by "Edit folder name". Deco-mail pictograms are directly saved to these folders, and files other than Deco-mail pictograms cannot be saved to them.

※2 The folder names you have entered for "Add folder" are displayed.

※3 Includes the music files in AAC format.

## Icons in the File list

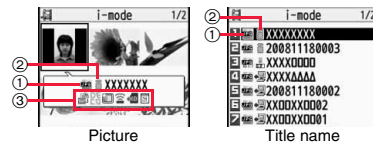

### ① File Type

Icon	Type	File format
	Still image	JPEG
	Still image/Animation image	GIF
	Frame	GIF
	Marker stamp	GIF
	Cushy mark	GIF
	Flash movie	SWF
	i-motion movie	MP4 (AMR)
	i-motion movie	MP4 (AAC)
	i-motion movie	MP4 (AAC+[HE-AAC])
	i-motion movie	MP4 (Enhanced aacPlus)
	i-motion movie	ASF
	Video	MPEG2-TS
	Partially saved i-motion movie	—
	Melody	SMF
	Melody	MFi
	Complete PDF file	PDF
	Partial PDF file	PDF
	Incomplete PDF file	PDF
	Damaged PDF file	PDF
	Kisekae Tool file	—
	Partially saved Kisekae Tool file	—
	Chara-den image	—

Icon	Type	File format
	Word file	WORD
	Excel file	EXCEL
	PowerPoint file	POWERPOINT
	Incompatible file	—

- For the file with the file restrictions, “” is added to each icon.
- Some files have restrictions on the number of playbacks, playable period, or playable deadline. “” is added to the icon of the file with playback restrictions and “” is added to the icon of the file with playback restrictions expired.

### ② Acquired source

Icon	Description
	Obtained from sites or i-mode mail attachment
	Files shot by the FOMA phone, or recorded by the voice recorder
	Obtained from infrared data exchange or iC communication or microSD card
	Files of recorded Chara-den images
	Files of recorded 1Seg programs

※ For the copyrighted file movable to the microSD card, “” is displayed.

### ③ Available operation

Icon	Description
	Attach to i-mode mail
	Insert image into Deco-mail
	Set display
	Send Ir data, iC transmission
	Copy to microSD card
	Upload

<Picture Viewer>

MENU 4 6

## Displaying Images

You can display the still images saved to the FOMA phone or microSD card.

### 1 [MENU] ▶ Data box ▶ My picture ▶ Select a folder ▶ Select a file.

- Each time you press [MENU] from the Folder list, you can switch between the folders in the FOMA phone and the microSD card.
- See page 316 for the Function menu of the Folder list.

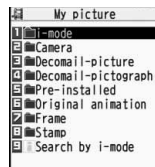

Folder list



Still Image list

- The image on the right is displayed when you cannot display a preview image:



- When selecting folders or still images by another function, some folders or still images may not be displayed depending on the function. You may at times be able to confirm the still image by pressing [Envelope] [Play] while you are selecting it.
- See page 163 when you select “Search by i-mode”.

### Display Images Recorded by 1Seg

### 1 [MENU] ▶ Data box ▶ 1Seg ▶ Image ▶ Select a file.



## ■ Operations when playing back still images

- See page 286 for when you operate from the Function menu.

Operation	Key operation
Display the next file*1	
Display the previous file*1	
Zoom (Enlarge/Reduce)**2	<b>Zoom</b> <ul style="list-style-type: none"> <li>•  (+) or  (-) to display enlarge/reduce during zooming</li> <li>•  (Return) to return to the original size</li> </ul>

\*1 Files are displayed in the order on the Still Image list.

\*2 You cannot operate depending on the image size or file format.

## ■ Specifications for playing back still image files

File format	JPEG*1, GIF, Flash
Extension	jpg, gif, swf, ifm
Pixels	Files of 5M (2592 x 1944) size or smaller*2
File size	Still images of 2 Mbytes or less

\*1 The types of JPEG file you can play back are Baseline and Progressive of the Exif/CIFF/JFIF format.





\*2 For the file in the Progressive format, you can display the file of VGA (640 x 480) size or smaller.



- You cannot display some files even if their file formats are supported.

## Function Menu of the Still Image List

Function menu	Operation/Explanation
Edit picture	See page 286.
Edit title	<ul style="list-style-type: none"> <li>▶ <b>Enter a title.</b></li> <li>• For a file in the FOMA phone, you can enter up to 9 full-pitch/18 half-pitch characters.</li> <li>• For a file on the microSD card, you can enter up to 18 full-pitch/36 half-pitch characters.</li> </ul>
Display picture	You can display the image.

Function menu	Operation/Explanation
Set display	<p>You can paste the image to the Stand-by display and other displays for displaying. See "Positioning" for the position to which you paste the still image.</p> <ul style="list-style-type: none"> <li>▶ <b>Select the display you paste it to.</b></li> <li>• "★" is displayed for the pasted items but not for the videophone related items other than "Videophone dial" or "V.phone incoming" even if already pasted.</li> <li>• If you select the videophone related items other than "Videophone dial" or "V.phone incoming", an appropriate message is displayed at the center of the still image.</li> </ul>
Picture info	<p>You can display the still image title, file name and others.</p> <ul style="list-style-type: none"> <li>• The item of "Set display" only is displayed for "Picture info" of original animations.</li> </ul>
Attach to mail	<p>Go to step 2 on page 174.</p> <ul style="list-style-type: none"> <li>• You can compose an i-mode mail message also by pressing  .</li> </ul>
Decorate mail	<p>You can compose Deco-mail using data in the "Decomail-picture" folder or "Decomail-pictograph" folder.</p> <p>Go to step 2 on page 174.</p> <ul style="list-style-type: none"> <li>• See page 178 for Deco-mail.</li> </ul>
Send Ir data	See page 319.
transmission	See page 321.
Add desktop icon	See page 109.
Copy to microSD	See page 309.
Store in Center	<p>You can save the still image stored in the FOMA phone to the Data Storage Center. Data Security Service is a pay service that is available on a subscription basis.</p> <ul style="list-style-type: none"> <li>▶ <b>Enter your Terminal Security Code</b></li> <li>▶ <b>Put a check mark for still images to be saved</b> ▶  (Finish)</li> <li>▶ <b>YES</b></li> <li>• You can select up to 10 still images.</li> <li>• You can switch between "Picture" and "Title name" by pressing  (FUNC).</li> <li>• While a still image is displayed, you do not need to put a check mark for the still image.</li> </ul>
Copy to phone	See page 310.

Function menu	Operation/Explanation
Move to microSD	See page 311.
Move to phone	See page 311.
Positioning	You can set the position for when you paste the still image to the Stand-by display, etc. See page 283 for "Set display". ▶ <b>Select a position for displaying.</b>
Edit file name	▶ <b>Enter a file name.</b> ● You can enter up to 36 half-pitch alphanumeric characters.
File restriction	If you set "File restricted" for the file, the operation of attaching to i-mode mail is disabled at the receiving end who receives the image as the first distribution. ▶ <b>File unrestricted or File restricted</b> ● See page 142 for the file restrictions.
DPOF setting	See page 329.
Slideshow	All still images are consecutively displayed starting from the still image selected in the folder. You can select the speed the still image switches at. ▶ <b>Normal or Slow</b> Press  (Stop) to stop Slideshow. Press  (Resume) again to resume Slideshow.
Copy	You can copy the still image, moving image, PDF file, document file, or SD other file on the microSD card to another folder on the microSD card. ▶ <b>Select a destination folder.</b>
Move	You can move the still image, moving image, PDF file, document file, Kisekai Tool file, or SD other file to another folder. ▶ <b>Select a destination folder.</b> ● Press  (↓) to display folders at the second-tier level or lower, if they exist. Press  (CLR) to return to the upper level.
Delete this	▶ <b>YES</b>

Function menu	Operation/Explanation
Delete all	You can delete all files in the folder. ▶ <b>Enter your Terminal Security Code</b> ▶ <b>YES</b>
Multiple-choice	You can select multiple files and operate them. ▶ <b>Put a check mark for the files to be operated</b> ▶  (FUNC) ▶ <b>Select an item.</b> <b>Picture/Title name/Listing</b> ..... See page 284, page 304 and page 324. <b>Delete</b> ..... See "Delete this" on page 284. <b>DPOF setting</b> ..... See page 329. <b>Copy</b> ..... See page 284. <b>Move</b> ..... See page 284. <b>Copy to microSD</b> ..... See page 309. <b>Copy to phone</b> ..... See page 310. <b>Send Ir data</b> ..... See page 319. <b>Select all</b> ..... Selects all files. <b>Release all</b> ..... Releases all selected files.
Memory info	You can display the used memory space (estimate).
Sort	You can change displayed order. ▶ <b>Select an order.</b> ● You cannot sort the files on the microSD card.
Picture/Title name	You can switch the lists of still images. ● You can switch the lists also by pressing  (Change) from the Still Image list.

### Information

#### <Edit title>

- You may not be able to edit the title depending on the file.

#### <Display picture>

- You may not be able to execute Display Picture depending on the file.
- Flash movies are played back at the volume set for "Phone" of "Ring volume". When "Phone" of "Ring volume" is set to "Step", they are played back at "Level 2".

## Information



### <Set display>

- Flash movies can be pasted only to "Stand-by display", "Wake-up display", "Dialing", "Calling", "Videophone dial", "V.phone incoming", "Mail sending", "Mail receiving", "Checking", and "Mail/msg. rcpt result".
- Animation GIF images cannot paste to the videophone related items other than "Videophone dial" or "V.phone incoming".
- The displayed size might differ from the actual size depending on the image size or the display pasted to.
- You cannot execute "Set display" for some image files.

### <Attach to mail>

- You may not be able to compose i-mode mail depending on the image.
- See page 142 for attaching a file set with the file restriction to mail.

### <Decorate mail>

- When an image size is larger than Sub-QCIF (128 x 96) size, the display for selecting how to convert the image size appears. The converted still image is saved as a separate new file.  
Select "Attach directly"; then the image size does not change.  
Select "Sub-QCIF scale down"; then the image size is scaled down to Sub-QCIF (128 x 96) size or smaller with its proportional ratio retained.  
Select "Sub-QCIF trim away"; then the image size is scaled down or cut out to Sub-QCIF (128 x 96) size or smaller with its proportional ratio retained.  
If the file size exceeds the maximum size to create a Deco-mail message, its size is converted to the maximum size to create a Deco-mail message or less.
- Even if you scale down or cut out the still image to Sub-QCIF (128 x 96) size, you can again scale down or cut it out by pressing  (Cancel) or pressing  (FUNC) and selecting "Cancel". When you press  (FUNC) and select "Set", the Message Composition display appears.
- Depending on the image, you may not be able to create a Deco-mail message.

## Information

### <Store in Center>

- You cannot save the following still images:
  - Images whose sizes exceed 100 Kbytes
  - Images whose output from the FOMA phone is prohibited
  - Images other than in JPEG or GIF format
- You cannot use Data Security Service when you are out of the service area.
- When you have not signed up for Data Security Service, the message to that effect appears.
- You can download the saved still images from the Data Storage Center site to your FOMA phone. For details, refer to "Mobile Phone User's Guide [i-mode] FOMA version".

### <Edit file name>

- You may not be able to edit the file name depending on the file.
- You cannot use half-pitch space for the file name.

### <File restriction>

- You may not be able to set the file restrictions depending on the file.

### <Slideshow>

- Flash movies are not displayed.
- The time interval to show the images might differ depending on the image.

### <Copy> <Move>

- If a call comes in while copying/moving multiple files, copying/moving is canceled even midway.

### <Delete this> <Delete all>

- If a call comes in while deleting multiple files, deleting is canceled.
- The video whose recording time is long might take a long time to be deleted. Make sure that the remaining battery is full enough. Further, during deleting, the FOMA phone is placed in the same status as it is out of the service area.
- You might not be able to delete the video containing data that does not support the FOMA phone.

### <Multiple-choice>

- You can select up to 3,500 still images, moving images, melodies, PDF files and Kisekae Tool files, and up to 100 videos, document files and SD other files.

### <Picture/Title name>

- When you use "Picture" to display still images, some images may appear different.

## Function Menu while Playing Back Still Image

Function menu	Operation/Explanation
Edit picture	See page 286.
Set display	See page 283.
Picture info	See page 283.
Attach to mail	See page 283.
Decorate mail	See page 283.
Send Ir data	See page 319.
 transmission	See page 321.
Display size	You can set whether to display the still image in original size (normal size) or to fit to the display size. ▶ <b>Normal or Fit in display</b> • Even if you set to "Normal", the still image in excess of the display size is reduced to the display size.
Add desktop icon	See page 109.
Copy to microSD	See page 309.
Store in Center	See page 283.
Copy to phone	See page 310.
Positioning	See page 284.
DPOF setting	See page 329.
Delete	See "Delete this" on page 284.
Retry	You can play back the animation or Flash movie from the beginning.

&lt;Edit Picture&gt;

## Editing Still Images

## 1 Still Image list/Still image in play

▶  (FUNC) ▶ Edit picture

- The still image larger than VGA (640 x 480) size is reduced to VGA (640 x 480) size.



Edit Picture display



2  (FUNC) ▶ Edit the still image.

See page 287 to page 289 for how to operate.

3  (Save) ▶ YES or NO

YES . . . Overwrites the image to save.

NO . . . Saves the image as a new still image.

- When you press  (Save) in step 3 to save an edited still image on the microSD card, it is saved to the "i-mode" folder anew.
- Not to save the edited still image, press (CLR) or ; then select "YES".
- See page 163 when images are stored to the maximum.

## ■ The size of still image you can edit

Edit menu	2M, 1M, VGA,	1.4M Wide	Stand-by, CIF, QVGA, QCIF, Sub-QCIF	Other sizes smaller than VGA
Marker stamp	○	○	○	○
Frame	—	—	○	—
Character stamp	○	○	○	○※1
Cushy mark	—	—	○	○
Change size	○	○	○	○
Trim away	○	○	○	○※2
Retouch	—	○	○	○
Rotate	○	○	○	○
Brightness	○	○	○	○
Attach to mail	○	○	○	○

○: Editing picture is enabled. —: Editing picture is disabled.

※1 You cannot edit the still image smaller than 24 x 24 dots.

※2 You cannot edit the still image of Chat Picture (80 x 80) size or smaller.

● You can edit the still images of 2592 x 1944 dots, 2592 x 1456 dots, 2048 x 1536 dots, 1920 x 1440 dots, 1920 x 1080 dots, 1632 x 1224 dots, and 1616 x 1212 dots, as well.

## Information

- You can execute "Edit picture" only for the "File unrestricted" files of still images shot by the camera, obtained by data communication, downloaded from sites, or retrieved from i-mode mail.
- You cannot edit some still images, or you might have difficulty to produce editing effect.
- If you repeat editing image, the image quality may deteriorate or the file size may become larger.
- You may not be able to edit some still images whose sizes are changed.
- If the battery runs out during editing, the edited contents are discarded.

## Information

- The file name, title, storage location, and acquired source of the newly saved still image are as follows:
  - File name: "YYYYMMDDhhmmnnnn"
  - Title: "YYYY/MM/DD hh:mm"
  - (Y: year, M: month, D: date, h: hour, m: minute, n: number)
  - Storage location: Folder the source file is saved to (Still images on the microSD card are saved to the "i-mode" folder.)
  - Acquired source: The same as the source file

## Function Menu of the Edit Picture Display

Function menu	Operation/Explanation
<b>Marker stamp</b>	<p>You can add the marker stamp in the "Stamp" folder.</p> <p>▶ <b>Select a marker stamp.</b></p> <ul style="list-style-type: none"> <li>● You can rotate the marker stamp by pressing  (FUNC) and selecting "90° to right/90° to left/180°". Select "Scale up/Scale down" to enlarge or shrink the marker stamp.</li> <li>● You can reselect a marker stamp by pressing  (Cancel).</li> </ul> <p>▶ <b>Use  to position the marker stamp and press .</b></p> <ul style="list-style-type: none"> <li>● You can add a marker stamp by pressing  (Add).</li> <li>▶  (Set)</li> </ul>
<b>Frame</b>	<p>▶ <b>Select a frame</b> ▶  (Set)</p> <ul style="list-style-type: none"> <li>● You can add the frame whose size is the same as the size of the image you are editing.</li> <li>● You can display the previous or next frame by pressing .</li> <li>Press and hold  for at least one second to display sequentially.</li> <li>● You can rotate the frame by pressing  (FUNC) and selecting "180° rotation".</li> <li>● You can reselect a frame by pressing  (Cancel).</li> </ul>

Function menu	Operation/Explanation
<b>Character stamp</b>	<p>You can add text.</p> <p>▶ <b>Enter characters.</b></p> <p>You can enter up to 15 full-pitch/30 half-pitch characters. However, the number of characters you can enter decreases depending on the size of the still image.</p> <ul style="list-style-type: none"> <li>Press  (FUNC) and select "Character color" to select a color; then, you can change the color of characters. You can switch between "16 Color" and "256 Color" by pressing  (Change). Select "Font" to change the character fonts. Select "Character size" to enlarge or shrink characters. Select "Character input" to edit entered characters.</li> </ul> <p>▶ Use  to position the characters and press  (Put).</p> <p>▶  (Set).</p> <ul style="list-style-type: none"> <li>You can reselect a position by pressing  (Cancel).</li> </ul>
<b>Cushy mark</b>	<p>You can compound a cushy mark in the "Stamp" folder. The person's facial region is automatically recognized and the cushy mark is pasted to an appropriate position.</p> <p>▶ <b>Select a cushy mark.</b></p> <ul style="list-style-type: none"> <li>Press  (FUNC) and select "Scale up/Scale down" to enlarge or shrink the cushy mark.</li> <li>To cancel, press  (Cancel).</li> </ul> <p>▶ Use  to position the cushy mark and press  (Put).</p> <ul style="list-style-type: none"> <li>The cushy mark that comes out of the still image is cut off.</li> <li>You can add a cushy mark by pressing  (Add).</li> </ul> <p>▶  (Set).</p>
<b>Change size</b>	<p>▶ <b>Select an image size to change to.</b></p> <ul style="list-style-type: none"> <li>If you select the size different in proportional ratio from the source still image, the still image is enlarged or shrunk so that it does not exceed the selected size with its proportional ratio retained.</li> </ul> <p>▶  (Set).</p> <ul style="list-style-type: none"> <li>You can reselect a size by pressing  (Cancel).</li> </ul>

Function menu	Operation/Explanation
<b>Trim away</b>	<p>You can trim the still image to a certain size.</p> <p>▶ <b>Select an image size to trim to.</b></p> <ul style="list-style-type: none"> <li>You cannot select a trimming frame larger than the still image you are editing.</li> <li>When you select "Dial/recv. PIC (240 x 144)", the still image you are editing and the trimming frame are halved at both lengthwise and sidewise to be displayed.</li> </ul> <p>▶ Use  to select a part to be trimmed and press  (Set).</p> <ul style="list-style-type: none"> <li>You can reselect a size to trim by pressing  (Cancel).</li> </ul> <p>▶  (Set).</p> <ul style="list-style-type: none"> <li>You can reselect a part to be trimmed by pressing  (Cancel).</li> </ul>
<b>Retouch</b>	<p>You can set texture and color tone of the still image.</p> <p>▶ <b>Select an item.</b></p> <p><b>Sharp</b> ..... Stresses the outline.</p> <p><b>Blur</b> ..... Softens the outline.</p> <p><b>Sepia</b> ..... Makes the color tone sepia.</p> <p><b>Emboss</b> ..... Makes the still image rugged.</p> <p><b>Negative</b> ..... Reverses the color tone.</p> <p><b>Horizontal flip</b> ..... Flips the image horizontally.</p> <p><b>Super clear shadow</b> ... Makes the dark still image clear.</p> <p><b>Memory color</b> ..... Corrects the color and contrast.</p> <p>▶  (Set).</p> <ul style="list-style-type: none"> <li>You can reselect an effect by pressing  (Cancel).</li> </ul>
<b>Rotate</b>	<p>▶ <b>90° to right, 90° to left or 180°</b>  (Set).</p> <ul style="list-style-type: none"> <li>You can reselect the rotation angle by pressing  (Cancel).</li> </ul>
<b>Brightness</b>	<p>You can adjust the brightness to -3 (dark) through +3 (bright).</p> <p>▶ <b>Select a brightness level.</b></p>
<b>Attach to mail</b>	See page 283.
<b>Save</b>	See page 286.

**Information****<Marker stamp>**

- You cannot select the marker stamp with following sizes:
  - When the size is larger than the still image to be edited
  - CIF (352 x 288)    · VGA (640 x 480)    · Stand-by (240 x 427)
  - QVGA (240 x 320)    · QCIF (176 x 144)    · Sub-QCIF (128 x 96)
- You cannot enlarge a marker stamp to the size larger than the still image you are editing.

**<Character stamp>**

- You cannot set some character colors depending on the image to be edited. In that case, select another color.

**<Cushy mark>**

- You cannot select a cushy mark larger than VGA (640 x 480) size.
- You can enlarge or shrink a cushy mark up to three times, but cannot enlarge it to the size larger than VGA (640 x480) size.
- Person's face or outline might not be recognized correctly. When multiple persons' faces are found, a single person's face only is recognized.

**<Original Animation>****Creating Animations**

You can select up to 20 JPEG files (20 frames) of Stand-by (240 x 427) size or smaller from the "i-mode" folder, "Camera" folder and user folders, and play them back as animations. You can store 20 original animations.

- 1**  **Data box**  **My picture**  
 **Original animation**  **<New>**

- To change, select an original animation you have set.

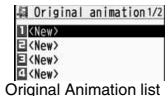



- 2** **Select a frame position from <1 st> to <20th>**  
 **Select a folder**  **Select a still image.**

- To release the stored still image, select "Release this".

- 3** **Repeat step 2**  **(Finish)**

**Function Menu of the Original Animation List**

Function menu	Operation/Explanation
<b>Edit title</b>	 <b>Enter a title.</b> ● You can enter up to 9 full-pitch/18 half-pitch characters.
<b>Org. animation</b>	Go to step 2 on page 289.
<b>Display picture</b>	You can play back the original animation.
<b>Set display</b>	See page 283.
<b>Picture info</b>	See page 283.
<b>Release animation</b>	 <b>YES</b>

**Function Menu while Playing Back Original Animation**

Function menu	Operation/Explanation
<b>Set display</b>	See page 283.
<b>Display size</b>	See page 286.
<b>Retry</b>	You can play back the original animation again.

**Information**

- If you delete a still image stored in an original animation, the original animation which contains the still image is released.

&lt;i-motion Player&gt;

## Playing Back Moving Images/i-motion Movies

You can play back the moving images saved to the FOMA phone or microSD card.

### 1 Data box motion Select a folder Select a file.

- Each time you press from the Folder list, you can switch between the folders in the FOMA phone and the microSD card.
- See page 316 for the Function menu of the Folder list.
- See page 163 when you select "Search by i-mode".

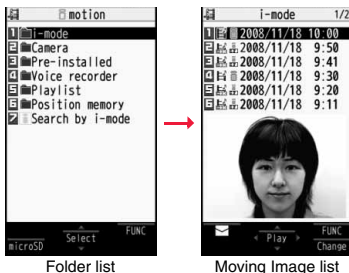

- The following images are displayed when you cannot display the preview images:



Cannot be played back



No preview images



Playback restrictions have expired, and the like.



Incomplete download

- When you select a folder or i-motion movie from another function, some folders or i-motion movies may not be displayed depending on the function. You may be able to confirm the i-motion movie by pressing while selecting an i-motion movie.
- Depending on the i-motion movie, you can play back by selecting a chapter set for the i-motion movie. (See page 292)

#### ■ Operations when playing back moving image

- See page 292 for when you operate from the Function menu.

Operation	Key operation
Quick View	(See page 292)
Mute	<ul style="list-style-type: none"> <li>  or adjust the sound volume to play back sound</li> </ul>

Operation	Key operation
Pause <sup>※1</sup>	<ul style="list-style-type: none"> <li>  to play back</li> </ul>
Play back frame by frame <sup>※2</sup>	during pause <ul style="list-style-type: none"> <li>Each time of pressing proceeds frame by frame.</li> </ul>
Sound volume adjustment	or
Display next file or chapter <sup>※3</sup>	
Display previous file or chapter <sup>※3</sup>	<ul style="list-style-type: none"> <li>When playback time is over three seconds, you go back to the beginning of the file. (You go back to the top of the chapter for the file with chapters.)</li> </ul>
Search (fast forward) <sup>※2</sup>	Press and hold .
Search (fast rewind) <sup>※2</sup>	Press and hold .
Change vertical disp./horizontal disp./full disp.	<ul style="list-style-type: none"> <li>Each time of pressing switches display formats.</li> </ul>
Remaster	<ul style="list-style-type: none"> <li>Each time of pressing switches between "ON" and "OFF".</li> </ul>
Listening	<ul style="list-style-type: none"> <li>Each time of pressing switches in order of "OFF" → "Surround" → "Natur1" → "Natur2".</li> </ul>
Equalizer	<ul style="list-style-type: none"> <li>Each time of pressing switches in order of "Normal" → "S-XBS1" → "S-XBS2" → "Train".</li> </ul>

※1 You cannot operate this for a streaming type of i-motion movie.

※2 You cannot operate this for a streaming type of i-motion movie, or when you are playing back an i-motion movie while obtaining it. Further, you might not be able to operate this depending on the i-motion movie.

※3 Moving images having no chapters are switched in the order on the Moving Image list. This operation is available when you play back from the Moving Image list. Moving images having chapters are switched in the order that the chapters are stored.



## ■ Specifications for moving image playback

File format	MP4, ASF	
Coding system	MP4 file	Video: MPEG4, H.263, H.264 Audio: AMR, AAC, AAC+ (HE-AAC), Enhanced aacPlus
	ASF file	Video: MPEG4 Audio: G.726
Pixels	MPEG4: Files of VGA (640 x 480) size or smaller	
	H.263: Files of only Sub-QCIF (128 x 96) and QCIF (176 x 144) size	
	H.264: Files of QVGA (240 x 320) size or smaller	
Extension	sdv, 3gp, mp4, asf	

- Even when the file format is supported, you might not be able to play back some files.

### When you select “Position memory” from the Folder list for moving images

The display for selecting Position Memory appears. When you select “Marker to resume” or “Position memory 1/2”, the moving image is played back from the stored position.

Marker to resume	This is stored automatically when a call comes in, an alarm operates, or the battery level goes flat during playback of a moving image.
Position memory	You can store in any optional position in a moving image, and create up to two position memories. (See page 293)

- To delete “Position memory”, press (FUNC) and select “Delete”. You cannot delete the “Marker to resume”.
- When the moving image with a position memory has been deleted or moved to another folder, you cannot play it back.

### Information

- While searching (fast forward or fast rewind) a moving image or playing it back frame by frame, it does not sound. You can search (fast forward or fast rewind) while pausing or playing back the moving image (including slow and quick view).
- If you receive mail or a Message R/F when playing back an i-motion movie, the video or sound might be interrupted.



## Function Menu of the Moving Image List

Function menu	Operation/Explanation
<b>Edit</b> <b>motion</b>	See page 294.
<b>Edit title</b>	See page 283.
<b>Set</b> <b>motion</b> <b>(Ring tone)</b>	You can set a moving image for a ring tone. ▶ <b>Ring tone</b> ▶ <b>Select an incoming type</b> ▶  (Finish) ● The set item is indicated by “★”.
<b>Set</b> <b>motion</b> <b>(Stand-by display)</b>	You can set a moving image for the Stand-by display. ▶ <b>Stand-by display</b> ▶ <b>YES</b> ▶  (Finish)
<b>Set</b> <b>motion</b> <b>(Wake-up display)</b>	You can set a moving image for the Wake-up display. ▶ <b>Wake-up display</b> ▶ <b>YES</b> ▶  (Finish)
<b>motion info</b>	You can display the i-motion movie title, file name and others.
<b>Attach to mail</b>	You can compose an i-motion mail message with the file attached. Go to step 2 on page 174. ● You can compose it also by pressing  ().
<b>Send Ir data</b>	See page 319.
<b>transmission</b>	See page 321.
<b>Copy to microSD</b>	See page 309.
<b>Copy to phone</b>	See page 310.
<b>Move to microSD</b>	See page 311.
<b>Move to phone</b>	See page 311.
<b>Copy</b>	See page 284.
<b>Move</b>	See page 284.
<b>Add desktop icon</b>	See page 109.
<b>Edit file name</b>	See page 284.
<b>File restriction</b>	See page 284.
<b>Reset title</b>	You can reset the title to the default. ▶ <b>YES</b>

Function menu	Operation/Explanation
Delete this	See page 284.
Delete all	See page 284.
Multiple-choice	See page 284.
Memory info	You can display the used memory space (estimate).
Sort	See page 284.
Listing	<p>You can change the displayed contents for Moving Image list. You can select whether the title or file name is displayed in the microSD Card list.</p> <p>▶ <b>Select a display format.</b></p> <p><b>Title</b> . . . . . The titles or file names are listed.</p> <p><b>Title + Image</b> . . . . . The title or file name, and image are displayed at a time. The displayed image is the first frame of moving image.</p> <p><b>Title/File name</b> . . . . . You can select whether to display the title or file name.</p> <ul style="list-style-type: none"> <li>• In the case of the microSD Card list, "Title" is displayed as "Name", and "Title + Image" is displayed as "Name + Image".</li> <li>• You can switch the lists also by pressing  (Change) from the Moving Image list.</li> </ul>

### Information

#### <Set motion>











- You cannot set the i-motion movie whose acquired source is "" as a ring tone.
- See "  motion info" to check whether the i-motion movie can be set for a ring tone or receiving display.







### Information

#### <Attach to mail>

- When the file size is larger than 2 Mbytes, the confirmation display appears asking whether to cut it out to the mail size. Select "YES" to cut out the i-motion movie from the beginning to the about 2-Mbyte point.
- You may not be able to compose i-mode mail depending on the i-motion movie.
- Depending on the i-motion movie, its file size may become larger or smaller.
- You cannot attach an i-motion movie in excess of 2 Mbytes to mail from the Edit  motion display. See "Trim for mail" for how to cut out the i-motion movie for attaching to i-motion mail.

### Function Menu during Pause/at the End of Playback

Function menu	Operation/Explanation
Normal play	The moving image is played back at the normal speed.
Chapter list	<p>You can display the list of chapters stored in the moving image and select a chapter to be played back.</p> <p>▶ <b>Select a chapter to be played back.</b></p>
Slow	<p>The moving image is played back mute at half the normal speed.</p> <ul style="list-style-type: none"> <li>• To cancel Slow playback, press  , or perform "Normal play".</li> </ul>
Quick View (1.25x)	<p>The moving image is played back at the speed 1.25 times the normal speed.</p> <ul style="list-style-type: none"> <li>• Press  to play back the moving image at twice the normal speed. Press   to play back at the normal speed.</li> </ul>
Quick View (2x)	<p>The moving image is played back at twice the normal speed.</p> <ul style="list-style-type: none"> <li>• To cancel Quick View, press  , or perform "Normal play".</li> </ul>
Stop	You can end playback.
Position to play	<p>You can set the start point for playing back the moving image.</p> <p>▶ Use  to move the cursor position of the time bar and press  (Set).</p> <ul style="list-style-type: none"> <li>• To cancel, press .</li> </ul>

Function menu	Operation/Explanation
<b>Sound effect (Remaster)</b>	You can bring the sound from an earphone to the original sound by complementing high-pitch range lost at data compression. ▶ <b>Remaster</b> ▶ <b>ON or OFF</b>
<b>Sound effect (Listening)</b>	You can set sound effect for listening. ▶ <b>Listening</b> ▶ <b>Select an item.</b> <b>Surround</b> . . . . . Makes the sound natural and stereophonic. <b>Natur 1/2</b> . . . . . Complements the cooped-up feeling specific to earphones and plays back natural sound. Select 1 or 2 according to your taste. <b>OFF</b> . . . . . Sets Listening to "OFF". ● "Natur 1/2" is effective for the sound from an earphone.
<b>Sound effect (Equalizer)</b>	You can change the quality of the sound from an earphone. ▶ <b>Equalizer</b> ▶ <b>Select an item.</b> <b>Normal</b> . . . . . Reproduces normal sound quality. <b>S-XBS1</b> . . . . . Enhances bass sound. <b>S-XBS2</b> . . . . . Enhances bass sound more deeply than S-XBS1. <b>Train</b> . . . . . Minimizes abnormal sound that causes sound leakage.
<b>Position memory</b>	You can store a position memory in the moving image. Store it at the desired position in pause state. ▶ <b>Position memory1 or Position memory2</b>
<b>Edit  motion</b>	See page 294.
<b>Attach to mail</b>	See page 291. ● You can compose an i-mode mail message also by pressing   from the playback end display.
<b>Set  motion</b>	See page 291.
<b> motion info</b>	See page 291.
<b>Send Ir data</b>	See page 319.
<b> transmission</b>	See page 321.
<b>Copy to phone</b>	See page 310.

Function menu	Operation/Explanation
<b>Add desktop icon</b>	See page 109.
<b>Display size</b>	You can set the display whether to display a moving image in the original size (Actual size) or to fit to the display size. ▶ <b>Actual size or Fit in display</b> ● Even if you set to "Actual size", the moving image in excess of the display size is reduced to the display size.
<b>Change to full</b>	You can switch display formats of moving images. Each time of selecting the item switches displays in order of playback on the vertical display → playback on the horizontal display fitted to the display size → playback on the enlarged full display.

### Information

#### <Chapter list>

- When restrictions on chapter forward/rewind are applied, you cannot select chapters after/before the one you are currently playing back.

#### <Slow>

- You cannot slow-play the following i-motion movies:
  - A streaming type of i-motion movie
  - An i-motion movie being played back while obtaining data
  - An i-motion movie played back from the Stand-by display

#### <Quick View>

- You cannot execute Quick View for some i-motion movies.
- i-motion movies are not played back in stereo sound during Quick View.
- It may be hard to hear sound during Quick View.

#### <Position to play>

- Depending on the moving image/i-motion movie, you might not be able to select the position to play.

#### <Sound effect>

- Even if an earphone is not connected, the respective setting contents are shown on the display.
- When audio format of the i-motion movie is AMR or G.726, sound effect might be unavailable.

#### <Position memory>

- Depending on the moving image/i-motion movie, you might not be able to store the position memory.

#### <Display size>

- Depending on the image size, the image might be displayed with the right or bottom side cut off.

**Information****<Change to full>**

- The moving image of QCIF (176 x 144) size or smaller is not played back in full display.
- Depending on the image size, the image might be displayed with the right or bottom side cut off.

**Using Playlist**

You can store moving images in a playlist, and continuously play them back in the order you like. You can create up to 5 playlists, and can store up to 30 moving images per playlist.

**Store Playlist**

- 1** **MENU** ▶ **Data box** ▶ **i-motion** ▶ **Playlist**  
▶ Select Playlist 1 through 5.

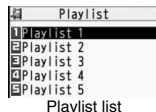

- 2** Select <1st> through <30th> ▶ Select a folder  
▶ Select a moving image.

- 3** Repeat step 2 ▶ **Finish**

- To release a stored moving image, press **DEL** (**FUNC**) and select "DEL one from list". Select "DEL all from list", then you can release all the stored moving images.
- To change the order of stored moving images, press **Order** (**FUNC**) and select "Order to play", and select a moving image whose position to be changed. Then, select the destination position to change the order.

**Information**

- You cannot store partially saved i-motion movies in the playlist.

**Play Back Playlist**

- 1** **Playlist list** ▶ Highlight a playlist and press **Play**.

**Function Menu of the Playlist List**

Function menu	Operation/Explanation
<b>Play</b>	See page 294.
<b>Edit playlist</b>	You can edit the playlist. Go to step 2 of "Store Playlist" on page 294.
<b>Release playlist</b>	You can release all moving images stored in the playlist. ▶ YES
<b>Edit playlist name</b>	You can edit the name of the playlist. ▶ <b>Edit a playlist name.</b> • You can enter up to 10 full-pitch/20 half-pitch characters.

**<Edit i-motion>****Editing Moving Images/i-motion Movies**

You can edit the moving image/i-motion movie. The moving image/i-motion movie you edited is saved to the folder containing the source moving image/i-motion movie.

- 1** **Moving Image list/During pause/At the end of playback** ▶ **FUNC**  
▶ **Edit i-motion**



- Use **Volume** or **Up/Down** to adjust the sound volume.



Edit i-motion display

- 2** **FUNC** ▶ **Edit the moving image/i-motion movie.**  
See page 295 for how to operate.

### 3 Press (Save).









- Not to save the edited moving image/i-motion movie, press  or ; then select "YES".

### 4 YES

The edited moving image/i-motion movie is saved.

- See page 163 for when i-motion movies are stored to the maximum.

#### ■ Operations during editing an i-motion movie or demo playback















Operation	Key operation
Pause	 •  to play back
Fast forward	Press and hold  .
Fast rewind	Press and hold  .
Forward frame by frame	 during pause
Rewind frame by frame	 during pause
Sound volume adjustment	 or 

- You cannot do some operations depending on the state.

#### Information

- You cannot edit the following moving images/i-motion movies:
  - The files with "File restriction" and "Replay restriction" obtained from sites or i-mode mail
  - The files other than VGA (640 x 480), HVGA Wide (640 x 352), QVGA (320 x 240), QCIF (176 x 144) and Sub-QCIF (128 x 96) size
  - The files saved to the microSD card
- You might not be able to edit some i-motion movies.
- The image quality may deteriorate or the file size may become larger or smaller by executing "Edit  motion".
- When a call comes in, the battery level goes flat, or you close the FOMA phone while editing, the confirmation display appears asking whether to save the fixed edited contents.

## Function Menu of the Edit motion Display

Function menu	Operation/Explanation
Trim  motion	<p>You can cut out a certain range from an i-motion movie.</p> <p>▶ Use  to display a start frame and press  (Start).</p> <p>The start frame is set and the moving image/i-motion movie is played back.</p> <p>▶ Press  () at the position you want to cut out.</p> <p>Playing back the moving image/i-motion movie pauses.</p> <p>▶ Use  to display an end frame and press  (End).</p> <p>The cut out range is played back.</p> <ul style="list-style-type: none"><li>• When the file size reaches about 10 Mbytes, the end frame is automatically set.</li></ul> <p>▶ Press  (Set).</p> <ul style="list-style-type: none"><li>• Press  (Play) to play back a demo to check the edited moving image/i-motion movie.</li></ul>
Trim for picture	<p>You can cut out the still image and save it.</p> <p>▶ Use  to display a frame and press  (Set) ▶ YES</p> <p>▶ Select a folder.</p> <ul style="list-style-type: none"><li>• See page 163 for when images are stored to the maximum.</li></ul>
Trim for mail	<p>You can cut out the moving image/i-motion movie to the size attachable to i-mode mail.</p> <p>▶ Mail size (S) or Mail size</p> <p>Mail size (S) . . . Cut out to the size of about 500 Kbytes or less.</p> <p>Mail size . . . . . Cut out to the size of about 2,048 Kbytes or less.</p> <p>▶ Use  to display a start frame and press  (Start).</p> <p>The moving image/i-motion movie is played back.</p> <p>When the file size reaches about 500 Kbytes, about 2,048 Kbytes, or at the end of playback, the playback stops automatically.</p> <p>▶  (Set)</p> <ul style="list-style-type: none"><li>• Press  (Play) to play back a demo and you can check the edited moving image/i-motion movie.</li></ul>



Function menu	Operation/Explanation
Attach to mail	See page 291.
File restriction	See page 284.

### Information

<Trim  motion>

- If you execute "Trim  motion", the file size may become larger.

## Function Menu while i-motion Movie is Edited or Demo Playback is in Pause

Function menu	Operation/Explanation
Normal play	You can play back at the normal speed.
Slow	You can play back mute at half the normal speed.
Quick View (1.25x)	You can play back at the speed 1.25 times the normal speed.
Quick View (2x)	You can play back at twice the normal speed.
Starting point	You can set the start frame for "Trim  motion" and "Trim for mail".
Ending point	You can set the end frame for "Trim  motion".
Determine	You can set the frame for "Trim for picture".
Stop	You can stop playing back.

<Video Player>

## Playing Back Video

You can play back the video saved to the microSD card.

1  Data box ▶ 1Seg ▶ Video ▶ microSD ▶ Select a file.

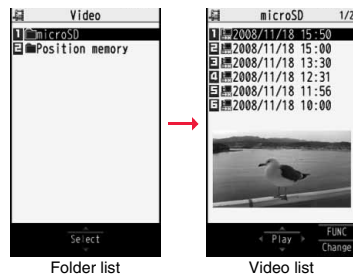











- The image on the right is displayed when you cannot display a preview image:



### Operations when playing video

- See page 298 for when you operate from the Function menu.

Operation	Key operation
Quick View	 (  ) (See page 292)
Mute	  <ul style="list-style-type: none"> <li>•   or adjust the sound volume to play back sound</li> </ul>
Pause	  <ul style="list-style-type: none"> <li>•   to play back</li> </ul>
Play back frame by frame	 (Frame) during pause <ul style="list-style-type: none"> <li>• Each time of pressing proceeds frame by frame.</li> </ul>

Operation	Key operation
Sound volume adjustment	or /
Displays next video※1	
Displays previous video※1	 ● When playback time is over 10 seconds, you go back to the beginning of the file.
30 second skip (fast forward)※2	(for at least one second) or  during playback or pause
30 second skip (rewind)※2	(for at least one second) or  during playback or pause
Program title	 ● Icons and the time bar appear on the horizontal display.
caption	while displaying program title ● Each time of pressing from the horizontal display switches ON/OFF of "Icon" and "Caption". ● Each time of pressing from the horizontal display switches the positions of the time bar as well regardless of whether the caption is displayed or not.
Vertical/Horizontal display	※3 ● Each time of pressing switches the display directions.

※1 Displayed in the stored order on the Video List.

※2 You cannot operate for a file whose playback time is shorter than 30 seconds.

※3 Close the FOMA phone to return to the vertical display.

### When you select "Position memory" from the Folder list for videos

The display for selecting Position Memory appears. When you select "Marker to resume" or "Position memory 1/2", the video is played back from the stored position.

Marker to resume	This is stored automatically when a call comes in, an alarm operates, or the battery level goes flat during playback of a video.
Position memory	You can store in any optional position in a video, and create up to two position memories. (See page 298)

● To delete "Position memory", press () and select "Delete". You cannot delete the "Marker to resume".



● When the video with a position memory has been deleted or moved to another folder, you cannot play it back.

### Information

- No sound is output during playing back frame-by-frame or 30-second skipping. Further, captions are not displayed.
- The displayed time bar is for reference.
- The part of video that was not correctly recorded owing to the bad radio wave conditions is not displayed and skipped to the position where it can be displayed correctly. In that case, the video might not be played back for a few seconds, or might be distorted. Further, the time bar might not be displayed correctly.
- If you try to play back a video with a low battery, the battery alert tone sounds, and the confirmation display appears asking whether to play it back. When the battery becomes low during playback, the playback pauses, the battery alert tone sounds, and the confirmation display appears asking whether to end the playback. The battery alert tone sounds regardless of the setting of "Keypad sound".
- If you edit (divide) the video using a mobile phone or personal computer that supports the edit function, you might not be able to correctly play it back on the FOMA phone.

### Function Menu of the Video List

Function menu	Operation/Explanation
<b>Edit title</b>	▶ Enter a title. ● You can enter up to 18 full-pitch/36 half-pitch characters.
<b>File property</b>	You can display the channel name, the program name, etc. of the video.
<b>Add desktop icon</b>	See page 109.
<b>Reset title</b>	You can reset the title to the default. ▶ YES
<b>Delete this</b>	See page 284.
<b>Delete selected</b>	You can select multiple videos and delete them. ▶ Put a check mark for videos to be deleted ▶   (Finish) ▶ YES
<b>Delete all</b>	See page 284.
<b>Memory info</b>	You can display the used memory space (estimate).

Function menu	Operation/Explanation
<b>Listing</b>	You can change the displayed contents for Video list. <b>▶ Select a display format.</b> <b>Title</b> . . . . . The title names are displayed. <b>Title + image</b> . . . . The title name and image are displayed at a time. The displayed image is the first frame of video.
<b>Information</b>	
<Listing>	
<ul style="list-style-type: none"> <li>The video that was not recorded correctly owing to the bad radio wave conditions might not be played back.</li> </ul>	
<b>Function Menu during Pause/at the End of Playback</b>	
Function menu	Operation/Explanation
<b>Normal play</b>	The video is played at the normal speed.
<b>Slow</b>	The video is played back mute at half the normal speed. <ul style="list-style-type: none"> <li>To cancel Slow play, perform "Normal play".</li> </ul>
<b>Quick View</b>	The video is played back quickly. <b>▶ Select an item.</b> <b>1.25x</b> . . . See page 292. <b>2x</b> . . . . . See page 292.
<b>Stop</b>	You can end playback.
<b>Position to play</b>	You can set the start point for playing the video. <b>▶ Use  to move the cursor position of the time bar and press .</b> <ul style="list-style-type: none"> <li>To cancel, press <b>(CLR)</b>.</li> </ul>
<b>Position memory</b>	You can store a position memory in the video. Store it at the desired position in pause state. <b>▶ Position memory1 or Position memory2</b>
<b>File property</b>	See page 297.
<b>Add desktop icon</b>	See page 109.

Function menu	Operation/Explanation		
<b>Icon</b>	See page 264.		
<b>Image quality</b>	See page 263.		
<b>Sound (Auto volume)</b>	See page 263.		
<b>Sound (Remaster)</b>	See page 263.		
<b>Sound (Listening)</b>	See page 263.		
<b>Sound (Equalizer)</b>	See page 263.		
<b>Sound (Main/sub sound)</b>	<b>▶ Main/sub sound</b> <b>▶ Main sound, Sub sound, or Main+sub sound</b>		
<table border="1" style="width: 100%;"> <tr> <td style="text-align: center;">At player start-up</td> </tr> <tr> <td style="text-align: center;">Main sound</td> </tr> </table>		At player start-up	Main sound
At player start-up			
Main sound			
<b>Caption</b>	You can set whether to display the caption. <b>▶ ON or OFF</b>		

Information
<Position to play>
<ul style="list-style-type: none"> <li>Depending on the video file, you might not be able to select the position to play.</li> <li>When you have selected the part that was not recorded correctly owing to bad radio wave conditions, the start point moves to the part where you can play back the video correctly.</li> </ul>



## <Chara-den>

# What is Chara-den?

Chara-den is an animation character representing yourself. You can send it as your image during videophone calls.

You can use the Chara-den player to play it back and shoot it.

- You can delete the pre-installed Chara-den image. You can re-download it from the "P-SQUARE" site (see page 164). When you use a UIM other than the one used for downloading, the UIM security function (see page 37) is set for it.
- Some Chara-den images synchronize their movement with your voice spoken into the microphone.

## <Chara-den Player>

# Displaying/Operating Chara-den Images

You can display stored Chara-den images.

You can make the Chara-den image move by key operation.



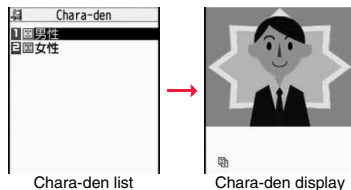



1  ▶ Data box ▶ Chara-den ▶ Select a Chara-den image.





## ■ Key assignment of operating Chara-den

You can use the Action list to check the actions that you can operate.

- The number of actions you can operate varies depending on the Chara-den image.

Key operation	Details
 (Whole Action Mode)	Whole action: expresses an action with whole of the body.
 (Parts Action Mode)	Parts action: expresses an action with a part of the body.
	Suspends the running action.
	Displays the Action list.
	Makes a videophone call.
	Records Chara-den images.

※1 You cannot operate for the pre-installed Chara-den image.

※2 Press  again to cancel the first .

## Function Menu of the Chara-den List

Function menu	Operation/Explanation
Chara-den call	See page 71.
Substitute image	See page 71.
Rec. Chara-den	See page 300.
Edit title	▶ Enter a title. • You can enter up to 18 full-pitch/36 half-pitch characters.
File property	You can display the title, file name, and others of the Chara-den image.
Memory info	You can display the used memory space (estimate).
Add desktop icon	See page 109.
Delete	▶ YES
Delete all	▶ Enter your Terminal Security Code ▶ YES • This operation deletes the pre-installed Chara-den image as well.

Function menu	Operation/Explanation
<b>Multiple-choice</b>	You can select and delete multiple Chara-den images. ▶ Put a check mark for Chara-den images to be deleted ▶  (FUNC) ▶ Delete ▶ YES
<b>Display size</b>	You can set whether to display the Chara-den image in "Actual size" or "Fit in display". ▶ Actual size or Fit in display
<b>Reset title</b>	You can reset the title to the default one. ▶ YES

### Information

#### <File property>

- "Rec. file restriction" denotes whether to restrict the operation such as attaching still images/moving images created by "Rec. Chara-den" to mail, saving them to microSD card, or editing them.

#### <Delete> <Delete all> <Multiple-choice>

- If you delete a Chara-den image set for the substitute image except "男性 (Male)", "男性 (Male)" is set for the substitute image. If you delete "男性 (Male)", a pre-installed substitute image will be sent.

## Function Menu of the Chara-den Display

Function menu	Operation/Explanation
<b>Chara-den call</b>	See page 71.
<b>Substitute image</b>	See page 71.
<b>Rec. Chara-den</b>	See page 300.
<b>Add desktop icon</b>	See page 109.
<b>Action list</b>	You can display the list for actions that you can operate. <ul style="list-style-type: none"> <li>• Highlight an action, and press  (Select) to run the action; and press  (Detail) to check the details of the action.</li> <li>• You can display the Action list also by pressing  (MENU).</li> </ul>

Function menu	Operation/Explanation
<b>Change action</b>	You can switch the action modes between Whole Action Mode (  ) and Parts Action Mode (  ). (At Chara-den display) (Whole Action Mode)
<b>File property</b>	See page 299.
<b>Display size</b>	See page 300.

### <Record Chara-den>

## Recording Chara-den Images

You can shoot the displayed Chara-den image as a still image or moving image.

- 1 ▶ Data box ▶ Chara-den  
▶ Select a Chara-den image to be shot  
▶ (Record)

- You can select "Rec. Chara-den" also from the Function menu of the Chara-den list or Chara-den display for recording.



Chara-den  
Recording display

## Shoot Still Images

- 1 Display " (Record)" on the Chara-den Recording display and press (Record).

A still image of the displayed Chara-den image is shot.

- While " (Photo)" is displayed, press (Photo) to display " (Photo)".

- 2 Press (Save).

The still image you have shot is saved to the "Camera" folder.

## Record Moving Images

### 1 Display “” on the Chara-den Recording display and press (Record).

Recording of the displayed Chara-den image starts.

- While “” is displayed, press (Movie) to display “”.

### 2

The recorded moving image is saved to the “Camera” folder.

#### Information

- The image size is fixed to QCIF (176 x 144).
- In Manner Mode or when “Phone” or “Mail” of “Ring volume” is set to “Silent”, the recording confirmation tone, the recording start tone, and the recording end tone do not sound.
- When “Recording type” is set to “Video + voice”, the voice is recorded as well.

## Function Menu of the Chara-den Recording Display

Function menu	Operation/Explanation
Switch Chara-den	▶ Select a Chara-den image to be displayed. • If you switch Chara-den images, the action mode switches to Whole Action Mode.
Substitute image	See page 71.
Action list	See page 300.
Change action	See page 300.
Display size	See page 300.
Recording size	You can set the image size for recording and saving a still Chara-den image. You can set only in Photo Mode. ▶ <b>QCIF (176 x 144) or Small (117 x 96)</b>
Recording type	You can set whether to record video or voice for recording and saving a moving Chara-den image. You can set only in Movie Mode. ▶ <b>Video + voice or Video</b>

Function menu	Operation/Explanation
Recording quality	You can set the image quality for saving a moving Chara-den image. You can set only in Movie Mode. ▶ <b>Normal, Prefer image quality, or Prefer motion speed</b>

## <Melody Player>

### Playing Back Melodies

#### 1 ▶ Data box ▶ Melody

- Each time you press from the Folder list, you can switch between the folders in the FOMA phone and the microSD card.
- See page 316 for the Function menu of the Folder list.



#### 2 Select a folder ▶ Select a melody.

- When selecting folders and melodies by another function, some folders or melodies may not be displayed depending on the function. Some melodies may be played back for confirmation while being selected, or you may at times be able to play back the melody by pressing (Play).



Melody list

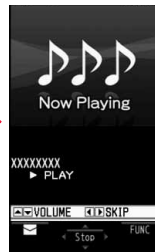

Melody Playback

- See page 163 when you select “Search by i-mode”.

## Play Back Playlist

You can repeatedly play back the melodies selected by “Edit playlist”.

#### 1 ▶ Data box ▶ Melody ▶ Playlist

## ■ Operation while playing back a melody

Operation	Key operation
Halt	(Stop),  through  ( ),  (#),  ※1,  (MENU),
Sound volume adjustment	or  ※2
Replay next file※3	
Replay previous file※3	

※1 Halts the playback of melodies which cannot be attached to mail.

※2 Halts the playback when the FOMA phone is closed.

※3 Valid when played back from the Melody list.

## Information

- The melodies are played back at the volume set for "Phone" of "Ring volume". When "Phone" of "Ring volume" is set to "Silent" or "Step", they are played back at "Level 2". However, the melody played back when it is selected does not sound.
- Even if you change the volume while playing back, the volume set for "Phone" of "Ring volume" returns when you exit the Melody player.

## Function Menu of the Melody List

Function menu	Operation/Explanation
Edit title	<p>▶ <b>Edit the title.</b></p> <ul style="list-style-type: none"> <li>• For a file in the FOMA phone, you can enter up to 31 full-pitch/63 half-pitch characters.</li> <li>• For a file on the microSD card, you can enter up to 18 full-pitch/36 half-pitch characters.</li> </ul>
Edit file name	<p>▶ <b>Edit the file name.</b></p> <ul style="list-style-type: none"> <li>• You can enter up to 36 half-pitch alphanumeric characters (except extension).</li> </ul>
Play melody	See page 301.
Set as ring tone	<p>▶ <b>Select an incoming type.</b></p> <ul style="list-style-type: none"> <li>• "★" indicates the set item.</li> </ul>

Function menu	Operation/Explanation
File restriction	<p>You can set the file restrictions on the selected melody.</p> <p>▶ <b>File unrestricted or File restricted</b></p> <ul style="list-style-type: none"> <li>• See page 142 for the file restrictions.</li> </ul>
Add desktop icon	See page 109.
Attach to mail	<p>You can compose an i-mode mail message with the selected melody attached.</p> <p>Go to step 2 on page 174.</p> <ul style="list-style-type: none"> <li>• You can compose it also by pressing  ().</li> </ul>
Send Ir data	See page 319.
transmission	See page 321.
Copy to microSD	See page 309.
Melody info	You can display the melody title, file name and others.
Copy to phone	See page 310.
Move to phone	See page 311.
Copy	<p>You can copy the melody from a folder on the microSD card to another folder on the microSD card.</p> <p>▶ <b>Select a destination folder.</b></p>
Memory info	You can display the used memory space (estimate).
Reset title	<p>You can reset the title to the default.</p> <p>▶ <b>YES</b></p>
Delete (Delete this)	<p>You can delete the melody stored in the FOMA phone.</p> <p>▶ <b>Delete this ▶ YES</b></p>
Delete (Delete selected)	<p>You can select and delete multiple melodies stored in the FOMA phone.</p> <p>▶ <b>Delete selected</b></p> <p>▶ <b>Put a check mark for melodies to be deleted ▶</b>  ()</p> <p>▶ <b>YES</b></p>
Delete (Delete all)	<p>You can delete all melodies stored in the selected folder in the FOMA phone.</p> <p>▶ <b>Delete all ▶ Enter your Terminal Security Code ▶ YES</b></p>
Delete this	<p>You can delete the melody stored on the microSD card.</p> <p>▶ <b>YES</b></p>

Function menu	Operation/Explanation
<b>Delete all</b>	You can delete all melodies stored in the selected folder on the microSD card. ▶ <b>Enter your Terminal Security Code ▶ YES</b>
<b>Multiple-choice</b>	You can select multiple melodies stored on the microSD card and operate them. ▶ <b>Put a check mark for the melodies to be operated</b> ▶ <b>FUNC</b> ▶ <b>Select an item.</b> <b>Delete</b> . . . . . See "Delete this" on page 302. <b>Copy</b> . . . . . See page 302. <b>Move</b> . . . . . See page 303. <b>Select all</b> . . . . . You can select all melodies. <b>Release all</b> . . . . . You can release all selected melodies.
<b>Sort</b>	You can change displayed order. ▶ <b>Select an order.</b> ● You cannot sort the files on the microSD card.
<b>Move</b>	You can move the melody to another folder. ▶ <b>Select a destination folder</b> ▶ <b>Put a check mark for melodies to be moved</b> ▶ <b>(Finish)</b> ▶ <b>YES</b> ● Press   to display folders at the second-tier level or lower, if they exist. Press  to return to the upper level. ● For the microSD card, you do not need to put a check mark for the melodies.
<b>Move to microSD</b>	See page 311.

### Information

#### <Edit file name>

- When the icon of the acquired source is "" or "" and the icon such as "" or "" is displayed for that melody, you cannot change the file name.
- You cannot use some characters such as symbols for a file name.

#### <File restriction>

- You can set the file restrictions only to the melody with the acquired source icon "".
- When the melody file exceeds 100 Kbytes by applying the restriction, you cannot set the file restrictions.

### Information

#### <Attach to mail>

- You cannot attach the melody with "" or "" whose acquired source icon is "" or "", or the melody in excess of 100 Kbytes.

#### <Melody info>

- You may not be able to attach to i-mode mail even when the file restriction in the melody information is "File unrestricted".

#### <Delete>

- When a melody set for another function is deleted, the setting returns to the default. (When the melody is set for an alarm tone of "Schedule", "ToDo", or "Book program", or for "Alarm", it switches to "Clock Alarm Tone".)
- You cannot delete the pre-installed melody.

## Function Menu of the Melody Playback Display

Function menu	Operation/Explanation
<b>Attach to mail</b>	See page 302.
<b>Set as ring tone</b>	See page 302.
<b>Melody info</b>	See page 302.
<b>Copy to microSD</b>	See page 309.
<b>Copy to phone</b>	See page 310.
<b>Add desktop icon</b>	See page 109.
<b>Play all/ Play portion</b>	You can temporarily switch the play start positions of the melody.

&lt;Kisekai Tool&gt;

## Checking Kisekai Tool

You can check the details on Kisekai Tool files.

- You can delete the pre-installed Kisekai Tool file.

You can re-download it from the "P-SQUARE" site (see page 164). When you use a UIM other than the one used for downloading, the UIM security function (see page 37) is set for it.

### 1 MENU ▶ Data box ▶ Kisekai Tool ▶ Select a Kisekai Tool file ▶ Select an item.

Selected image, ring tone or illumination are played back as a demo. If you select a color theme, the display is displayed in selected color theme.

- Each time you press  from the Kisekai Tool list, you can switch between the list in the FOMA phone and the microSD card. In the Folder list on the microSD card, you can display the Kisekai Tool list by selecting a folder.

- See page 316 for the Function menu of the Folder list.

- The image on the right is displayed when you cannot display a preview image.

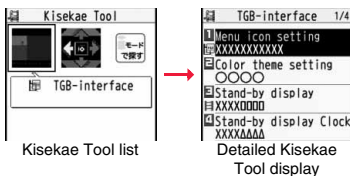

Cannot be played back





No preview image

- See page 163 when you select "Search by i-mode".

### Information

- You cannot set Kisekai Tool files on the microSD card at a time.
- Clock display cannot be played back as a demo.

## Function Menu while Kisekai Tool File is Displayed

Function menu	Operation/Explanation
<b>Edit title</b>	See page 283.
<b>Preview</b>	You can preview the Kisekai Tool file.
<b>Set at one time</b>	You can set the Kisekai Tool file at one time. (See page 103) <ul style="list-style-type: none"> <li>You can set the Kisekai Tool file at one time also by pressing .</li> </ul>
<b>File info</b>	You can display the title, file name, and others of the Kisekai Tool file.
<b>Move to microSD</b>	See page 311.
<b>Move to phone</b>	See page 311.
<b>Reset title</b>	You can reset the title to the default. ▶ YES
<b>Move</b>	See page 284.
<b>Delete this</b>	See page 284.
<b>Delete all</b>	You can delete all files in the folder. ▶ Enter your Terminal Security Code ▶ YES
<b>Multiple-choice</b>	See page 284.
<b>Memory info</b>	You can check the used memory space (estimate)/number of stored items.
<b>Sort</b>	See page 284.
<b>Listing</b>	You can change the displayed contents for the Kisekai Tool list. <ul style="list-style-type: none"> <li>▶ Title or Image</li> <li>• You can switch the lists also by pressing  (Change) from the Kisekai Tool list.</li> </ul>

## About microSD Card

You need to obtain a microSD card separately to use the functions related to the microSD card.

The microSD card is available at mass retailers for home electric appliances etc.

- FOMA P706ij supports a commercial microSD card of up to 2 Gbytes and microSDHC card of up to 8 Gbytes (As of June 2008).

For the latest operation check information such as the memory capacity and manufacturers of microSD cards, access the following sites (Japanese only). Note that the microSD cards other than published in the sites might not correctly work.

· From i-mode to P-SQUARE (As of June 2008)

☎ Menu → メニューリスト (Menu List)

→ ケータイ電話メーカー (Mobile Phone Maker) → P-SQUARE

· From personal computers

<http://panasonic.jp/mobile/>



QR code for accessing the site

Note that the published information is the result obtained from the operation check, which does not necessarily guarantee all performances of those microSD cards.

- During processing of the card, "⏏" is displayed. During processing of the card, never remove the microSD card, or turn off the FOMA phone. Check that processing of the card does not go on before turning off the FOMA phone, and then remove the microSD card.
- When the FOMA phone or microSD card has many data files, it may take longer to access the files.
- Up to about 65,500 folders and files on the microSD card can be recognized.
- The microSD card has an operating life. If you use the microSD card for a long time, you may not be able to write new data on it, or the card may be disabled.
- With the FOMA phone, you can save the downloaded still images, i-motion movies, melodies, Kisekae Tool files, Chaku-uta Full® music files, and i-appli programs with the file restrictions to the microSD card. You cannot save the files IPs (Information Providers) do not permit.

### Information

- You may not be able to use the microSD card formatted using a personal computer and other devices. Be sure to use the microSD card formatted with FOMA P706ij.

### Information

- Note that formatting deletes all the contents on the microSD card.
- If you read/write data from/on a microSD card using a device other than this FOMA phone, the microSD card might become unusable depending on the device or operations.
- When you insert a microSD card which has been used with another device such as a personal computer into FOMA P706ij, new files and folders to be used in FOMA P706ij are created.

## Inserting/Removing microSD Card

### ■ Inserting

- 1 Open the cover of the microSD card slot.

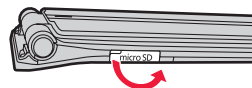

- 2 Face the back surface of the microSD card upwards and insert the card.

- Push it until it clicks.

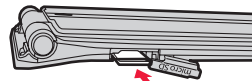

- 3 Close the cover of the microSD card slot.

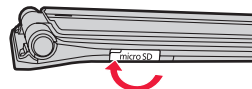

## ■ Removing

- 1 Open the cover following step 1 of “■ Inserting” and push the microSD card until it stops.

- Pushing the microSD card inside pops up the card.

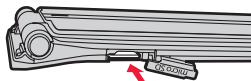

- 2 Remove the microSD card.

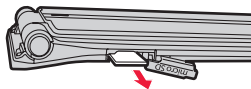

## ■ Icons on the display

The following icons appear when you insert the microSD card:

: You can save and read data.

: The microSD card is write-protected. You cannot save data, and execute “Check microSD” and “microSD format”.

: You cannot use the microSD card. Remove the microSD card and then insert it again.

If “” is still displayed, execute “Check microSD” or “microSD format”.

## Information

- Do not insert or remove the microSD card with the FOMA phone turned on. It may damage the microSD card or its data.
- Note that microSD card may pop out when you insert or remove it.
- Check the direction of the microSD card, and then insert or remove it straight. If you obliquely insert the microSD card into the slot, the microSD card may be damaged.
- It may take long to initially read or write data after inserting the microSD card.

## <SD-PIM>

## Displaying Data Items on microSD Card

You can display the Phonebook entries, schedule events, ToDo items, mail messages, text memos, and bookmarks (i-mode/Full Browser) stored on the microSD card.

- You can operate in the same way on the detailed Phonebook display, detailed mail display, and detailed Bookmark display as when you display data stored in your FOMA phone.

See page 87 for detailed operations of the Phonebook.

See page 198 for detailed operations of mail.

See page 157 for detailed operations of bookmarks.

- 1 ▶ LifeKit ▶ SD-PIM ▶ Select a category.

- If you select “Schedule”, ToDo items are also displayed.

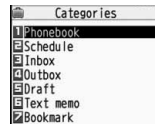

Category list

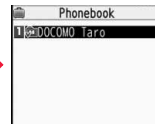

microSD File display  
(For Phonebook)

- 2 Select a file ▶ Select a data item.



Data list  
(For Phonebook)



Detailed data display  
(For Phonebook)



## Function Menu of the Category List/microSD File Display/ Data List/Detailed Data Display

Function menu	Operation/Explanation
<b>Edit title</b>	▶ <b>Enter a title.</b> ● You can enter up to 15 full-pitch/31 half-pitch characters.
<b>Add to phone</b>	See page 308.
<b>Overwrite to phone</b>	See page 309.
<b>Add one to phone</b>	See page 308.
<b>Add all to phone</b>	See page 308.
<b>Overwr. all to ph.</b>	See page 308.
<b>Copy to microSD</b>	See page 307.
<b>Delete this</b>	▶ <b>YES</b>
<b>Delete all</b>	You can delete all files in the currently displayed category. ▶ <b>Enter your Terminal Security Code</b> ▶ <b>YES</b>
<b>microSD info</b>	See page 313.
<b>Property</b>	You can display the detailed data display.
<b>microSD format</b>	See page 312.
<b>Check microSD</b>	See page 313.

## Copy Data Items in the FOMA Phone to the microSD Card

You can copy the Phonebook entries, schedule events, ToDo items, mail messages, text memos, and bookmarks stored in the FOMA phone to the microSD card.

### Copy one to microSD

You can copy a single file from the FOMA phone onto the microSD card. A copied data item is saved as a single file.

You cannot copy the secret code stored in a Phonebook entry.

- 1 **Display for a data item to be copied** ▶  ( **FUNC** )  
▶ **Copy to microSD** ▶ **YES**

### Copy all to microSD

You can copy the data items of the category selected on the Category list or of the category displayed on the microSD File display from the FOMA phone to the microSD card. The copied data items are all saved as a single file.

You cannot copy secret codes or voice dial entries stored in the Phonebook entries.

- 1 **Category list/microSD File display** ▶  ( **FUNC** )  
▶ **Copy to microSD**  
▶ **Enter your Terminal Security Code** ▶ **YES**

- To copy scheduled events, select "Schedule", "ToDo", or "All" (Schedule and ToDo).
- To copy bookmarks, select "i-mode", "Full Browser", or "All" (i-mode and Full Browser).

### Information

- When you copy a file stored as secret data, the file is copied as an ordinary file.
- When you copy all files, the files stored as secret data are also copied.
- When you copy all the Phonebook entries, the contents of "Own number" are also copied.

**Information**

- For copying mail, some files attached to mail may be deleted depending on file format.
- When you copy mail containing links to start an i-appli program, the information about starting the i-appli program in that mail is deleted.
- During copying, the FOMA phone is placed in the same status as it is out of the service area.



**Copy Data Items on the microSD Card to the FOMA Phone**

You can copy the Phonebook entries, schedule events, ToDo items, mail messages, text memos, and bookmarks (i-mode/Full Browser) stored on the microSD card to the FOMA phone.

- See page 315 for the number of data items that can be saved to the microSD card.

**Add one to phone**

You can copy the data item selected on the data list or displayed on the detailed data display to the FOMA phone.

- 1 Data list/Detailed data display     
▶ Add one to phone or Copy to phone ▶ YES

**Add all to phone**





You can copy all data items in all files of the category selected on the Category list or all data items in all files displayed on the microSD File display to the FOMA phone.

The copied data items are added to the FOMA phone.

- 1 Category list   ▶ Add all to phone   
▶ Enter your Terminal Security Code ▶ YES
- or
- microSD File display   ▶ Add all to phone   
▶ Enter your Terminal Security Code ▶ YES

**Add to phone**

You can copy all data items in a file selected on the microSD File display or all data items displayed on the data list to the FOMA phone. The copied data items are added to the FOMA phone.

- 1 microSD File display   ▶ Add to phone   
▶ Enter your Terminal Security Code ▶ YES
- or
- Data list   ▶ Add all to phone   
▶ Enter your Terminal Security Code ▶ YES

**Overwrite all to phone**

You can copy all data items in all files of the category selected on the Category list or all data items in all files displayed on the microSD File display to the FOMA phone.

Note that the data items already stored in the FOMA phone are overwritten and deleted.

- 1 Category list   ▶ Overwr. all to ph.   
▶ Enter your Terminal Security Code ▶ YES ▶ YES
- or
- microSD File display   ▶ Overwr. all to ph.   
▶ Enter your Terminal Security Code ▶ YES ▶ YES

## Overwrite to phone

You can copy all data items in a file selected on the microSD File display or all data items displayed on the data list to the FOMA phone. Note that the data items already stored in the FOMA phone are overwritten and deleted.

- 1 **microSD File display**  **(FUNC)** **▶ Overwrite to phone**  
**▶ Enter your Terminal Security Code ▶ YES ▶ YES**  
or  
**Data list**  **(FUNC)** **▶ Overwr. all to ph.**  
**▶ Enter your Terminal Security Code ▶ YES ▶ YES**

## Information

- If the memory capacity of the FOMA phone runs short during copying, copying is suspended midway; however, the data already copied is stored.
- When you perform "Add one to phone" for a Phonebook entry, any group is not set if the group number or group name stored in the microSD file differs from that stored on the FOMA phone.
- When you overwrite the Phonebook entries, the voice dial entries are deleted.
- When you copy a mail message with the Outbox or Inbox full, the oldest unprotected mail message is overwritten (the read one for the Inbox).
- When you execute "Add all to phone", you cannot copy the following data:
  - Schedule events set for the same date and time
  - Bookmarks of the same URL
- If the number of files stored on the microSD card increases, it may take long to read or write data.
- During copying, the FOMA phone is placed in the same status as it is out of the service area.

## Copying Still Images, Moving Images, etc.

### Copy Files from the FOMA Phone to the microSD Card

The destination folder and file name are as follows:

Still image (DCF standard)	The destination folder in the "Picture" folder PXXXXXXX (X denotes a numeral.)
Still image (Non DCF standard)	The destination folder in the "Image Box" folder STILXXXX (X denotes a numeral.)
Still image (Deco-mail pictogram)	The destination folder in the "Decomail-pictograph" folder DIMGXXXX (X denotes a numeral.)
Moving image (With video)	The destination folder in the "Movie" folder MOLXXX (X denotes an alpha-numeral.)
Moving image (Without video)	The destination folder in the "Other contents" folder MMFXXXX (X denotes a numeral.)
Melody	The destination folder RINGXXXX (X denotes a numeral.)
PDF file	The destination folder The same file name as the one in the FOMA phone

- When you copy or move a file between the FOMA phone and the microSD card, its file format might change.

- 1 **Still Image list/Still image in play/Moving Image list/Melody list/Melody during playback/PDF File list**  
**▶**  **(FUNC)** **▶ Copy to microSD**

- If you have used "Multiple-choice" to select files to be copied, you can copy the multiple files at a time.

## Information



- You can copy JPEG, GIF, SWF, MP4, MFi, SMF and PDF files in the "i-mode" folder, "Camera" folder, "Decomail-picture" folder, "Decomail-pictograph" folder and a user folder.
- You can copy multiple JPEG, GIF, SWF and MP4 files at a time but not others.

**Information**

- When the files in the destination folder are stored to the maximum, a new folder is automatically created and files are saved to that folder. For the files other than still images, the message "Storage is changed to XXXXXXX" (XXXXXXX denotes a folder name) appears when copying is completed.
- You cannot copy the following files:
  - Files that you shot Chara-den images whose "Rec. file restriction" is "File restricted"
  - Files whose output from the FOMA phone is prohibited
  - Pre-installed Deco-mail pictures
  - Files set with playback restrictions
  - Partially saved i-motion movies or Chaku-uta Full® music files
  - PDF files partially downloaded page by page
- If you copy the file to the microSD card, the image quality may deteriorate or the file size becomes larger.

**Copy Files from the microSD Card to the FOMA Phone**

You can copy files from the microSD card to the i-mode folder in the FOMA phone. (Deco-mail pictograms are copied to the "お気に入り (Favorite)" folder in the "Decomail-pictograph" folder.)

- 1 Still Image list/Still image in play/Moving Image list/  
Moving image in pause/Moving image at the end of  
playback/Melody list/Melody during playback/PDF File  
list, which is on the microSD card  

**▶ Copy to phone**

- If you have used "Multiple-choice" to select files to be copied, you can copy the multiple files at a time.
- See page 163 when images/i-motion movies/melodies/PDF files are stored to the maximum.

**Information**

- Do not pull out the microSD card during copying.
- You can copy JPEG, GIF, SWF, MP4, MFi, SMF and PDF files. However, you cannot copy a melody and an SWF file in excess of 100 Kbytes.

**Information**

- You can copy multiple JPEG, GIF, SWF and MP4 files only at a time. However, you cannot copy multiple moving images of ASF format, VGA (640 x 480) and HVGA Wide (640 x 352) size, or in excess of 10 Mbytes.
- When you copy moving images, the images are cut out, converted or shrunk; therefore the image quality may deteriorate or the file size may become larger or smaller. However, a moving image whose video codec is H.264 is copied without being converted or shrunk.
- When you copy VGA (640 x 480) size or HVGA Wide (640 x 352) size of a moving image, the image is converted into QVGA (320 x 240) size. When you copy VGA (640 x 480) size or HVGA Wide (640 x 352) size of a moving image, ASF file, or the file in excess of 10 Mbytes, it might take a longer time.
- You cannot copy the moving image in excess of 10 Mbytes in the following cases:
  - When the video codec is H.264
  - When the audio codec is AAC, AAC+ (HE-AAC), or Enhanced aacPlus
  - When the bit rate of the moving image is in excess of the restriction
  - When searching (fast forward or fast rewind) is disabled
  - When the moving image size is other than VGA (640 x 480), HVGA Wide (640 x 352), QVGA (320 x 240), QCIF (176 x 144) or Sub-QCIF (128 x 96)
 Some moving images cannot be copied in the conditions other than the above.
- Playing back a copied ASF file may take a longer time.
- The file after copying takes the title of the one set on the microSD card. When no title is set on the microSD card or the default title is unknown, the file name will be the title.

## &lt;Movable Contents&gt;

**Moving Copyrighted Files****Move Files in the FOMA Phone to the microSD Card**

You can move the copyrighted file obtained from a site to the microSD card after encoding. The moved file is then saved to the destination folder in the "Movable contents" folder (the specified destination folder for Chaku-uta Full® music files).

Some files you moved to the microSD card can be operated only with the UIM you used when moving, and some files can be operated with the UIM and the phone you used when moving.

- 1 Still image list/Moving image list/Melody list/Kisekae Tool list/Chaku-uta Full® Music list  
  - ▶ Move to microSD ▶ OK

**Information**

- You can move a file to the microSD card only when the acquired source icon is "".
- Partially saved i-motion movies, Chaku-uta Full® music files and Kisekae Tool files cannot be moved to the microSD card.
- The setting is released if you move a file set for another function.

**Move Files from the microSD Card to the FOMA Phone**

You can move a copyrighted file from the microSD card to the "i-mode" folder in the FOMA phone.

- 1 Still Image list/Moving Image list/Melody list/Kisekae Tool list/Chaku-uta Full® Music list, which is on the microSD card  
  - ▶ Move to phone
    - See page 163 for when files are stored to the maximum.

**Information**

- You can move a copyrighted file (with file restriction) to the FOMA phone only if its property for "Moved to phone" is "Available" or "Available (Same model)". In addition, you cannot move a file of "Available (Same model)" to the FOMA phone other than P706ij. See "Picture info", " motion info", "Melody info", "File info", or "Music info" to check whether the file is "Available", "Unavailable" or "Available (Same model)".
- The setting is released if you move a file set for another function.
- The moved files are saved to the "i-mode" folder. However, the Kisekae Tool files are saved to the "Kisekae Tool" folder and Chaku-uta Full® music files are saved to the "Initial folder" in Data Box.

**Move i-oppli in the FOMA Phone to the microSD Card**

Some i-oppli programs can be moved to and saved to the microSD card. You cannot start the i-oppli program moved to the microSD card. Move it back to your FOMA phone to start. However, some i-oppli programs can be operated only with the UIM you used when moving, and some other programs can be operated only with the UIM and the phone you used when moving.

- 1 Software list  
  - ▶ Move to microSD ▶ YES

**Move i-oppli from the microSD Card to the FOMA Phone**

You can move an i-oppli program from the microSD card to the FOMA phone.

- 1 Software list  
  - ▶ Move to phone ▶ YES

&lt;SD Other Files&gt;

## Managing Unsupported Files

You can save a variety of files which are not supported by the FOMA phone, or files in BMP and PNG format obtained by Full Browser, to the microSD card. (See page 189 and page 268)



You can attach the saved files to an i-mode mail message to send, or check them on a personal computer.

### 1 Data box > SD other files > Select a folder.

- See page 316 for the Function menu on the Folder list.
- You cannot display the contents of the file using the FOMA phone.



## Function Menu of the SD Other File List

Function menu	Operation/Explanation
<b>Edit title</b>	See page 283.
<b>File info</b>	You can display the name and type of files.
<b>Attach to mail</b>	You can compose an i-mode mail message with the file attached. Go to step 2 on page 174. <ul style="list-style-type: none"> <li>• You can compose it also by pressing  ().</li> </ul>
<b>Copy</b>	See page 284.
<b>Move</b>	See page 284.
<b>Delete this</b>	See page 284.
<b>Delete all</b>	See page 284.
<b>Multiple-choice</b>	See page 284.
<b>Memory info</b>	You can display the used memory space (estimate).

&lt;microSD Format&gt;



## Formatting microSD Card

When you use the microSD card for the first time, you need to format (initialize) it. Be sure to use FOMA P706iμ for formatting. The microSD card formatted using other devices such as personal computers may not be used properly.

Note that formatting deletes all the contents on the microSD card.

### 1 LifeKit > SD-PIM > ( ) > microSD format > Enter your Terminal Security Code > YES

#### Information

- Do not remove the microSD card during formatting. Malfunction of the FOMA phone or microSD card could result.
- If you press  (  ) or  , or receive a voice call or videophone call while formatting the microSD card, formatting is canceled. Format it again.
- Files that have been saved to the microSD card whose formatting is suspended becomes unfixd.
- You cannot format an incompatible memory card.
- Required folders are automatically created when you save data to the microSD card after formatting.



<Check microSD>

## Checking microSD Card

You can check and recover the microSD card.

1  LifeKit    Check microSD  
▶ YES

### Information

- Do not remove the microSD card during Check microSD. Malfunction of the FOMA phone or microSD card could result.
- You cannot execute Check microSD for the unformatted microSD card or incompatible memory card.
- When you execute Check microSD, the microSD card may not be recovered correctly, the data existed before executing Check microSD may be deleted, or the microSD card itself may be initialized depending on the condition of the microSD card.
- If you press  Quit or , or receive a voice call or videophone call during Check microSD, Check microSD is canceled.
- If you cancel Check microSD midway, data not recovered may remain. In this case, try Check microSD again.
- It may take long to complete Check microSD depending on the data volume stored on the microSD card.

<microSD Info>

## Displaying Capacity of microSD Card

You can display the used and unused memory space (estimate) on the microSD card.

- See page 284 for checking the used memory space for the still images or moving images.

1  LifeKit    microSD info

### Information

- As the microSD card contains the system files for the card, the memory space is smaller than that described on the microSD card even if it contains no data.

## Using a microSD Card with a Personal Computer

By connecting the microSD card to the microSD card adapter, you can use the microSD card on a personal computer which supports SD card. The microSD card adapter is available at mass retailers for home electric appliances etc.



For installing the microSD card adapter, refer to the instruction manual for the microSD card adapter.



### Use FOMA Phone as microSD Reader/Writer

With a microSD card inserted, connect the FOMA phone to a personal computer; then you can read the data from or write the data onto the microSD card.

The following equipment is required:

- Connector Cable: FOMA USB Cable with Charge Function 01/02 (option)
- Personal Computer: Personal computer having the USB port (Universal Serial Bus Specification Rev 1.1 compliant) that can be connected with the FOMA USB Cable with Charge Function 01/02 (option)
- Compatible Operating Systems: Windows 2000, Windows XP, Windows Vista (Japanese version in each)

1  Settings  Other settings  USB mode setting  
▶ microSD mode

- When you set to "microSD mode",  appears on the Stand-by display.
- To save WMA files from your personal computer to the microSD card, set to "MTP mode". When you set to "MTP mode",  appears on the Stand-by display.
- To use the FOMA phone for packet communication, 64K data communication, data sending/receiving (OBEX™ communication), and for calls with USB Hands-free compatible device, set mode to "Communication mode".

2 Connect the FOMA phone to a personal computer using the FOMA USB Cable with Charge Function 01/02 (option).

The personal computer recognizes the microSD card.

-  appears on the desktop, and  appears on the Stand-by display. Also,  is displayed while the microSD card is in the FOMA phone.

**Information**

- If the FOMA phone and personal computer are not correctly connected, or the remaining battery level of the FOMA phone shows very low or goes flat, you cannot send or receive data. In addition, you may lose data.
- While data is being read or written, do not pull the FOMA USB Cable with Charge Function 01/02 off. Not only you cannot send or receive data, but also you may lose the data.
- While data is being read or written, you cannot set this function. Further, make sure that you do not "Reset settings" or "Initialize" during reading/writing. Malfunction of the microSD card could result.
- You cannot read from/write to a personal computer while reading from/writing to the FOMA phone, and vice versa.
- To use the DOCOMO keitai datalink, set it to "Communication mode".

**Folder Configuration on microSD Card**

The FOMA phone creates the following folders on the microSD card to save data files. When you write files to the microSD card from a personal computer, you need to write in the specified folder configuration and file names.

DCIM (Folder for DCF standard still images)

├── △△△\_PANA

└── P△△△zzzz.### (Extension is JPG, or GIF.)

MISC [DPOF folder (This folder is created automatically when "DPOF setting" on page 329 is set.)]

SD\_VIDEO (Folder for moving images)

├── PRL◇◇◇◇ (Folder for movies)

├── MOL◇◇◇◇.### (Extension is 3GP, SDV, ASF, or MP4.)

├── MGR\_INFO (Folder for video management information)

└── PRG◇◇◇◇ (Folder for videos)

PRIVATE

├── DOCOMO

├── STILL (Folder for non-DCF standard still images)

├── SUD□□□□

└── STILzzzz.### (Extension is JPG, GIF, or SWF.)

├── DOCUMENT (Folder for PDF files)

├── PUD□□□□

└── PDFDC□□□□.PDF

├── RINGER (Folder for melodies)

├── RUD□□□□

└── RINGzzzz.### (Extension is MLD, or SMF.)

├── TORUCA (Folder for ToruCa files)

├── TRC□□□□

└── TORUC□□□□.TRC

├── MMFILE [Folder for non-SD-VIDEO standard moving images (include music data of AAC format)]

├── MUD□□□□

└── MMFzzzz.### (Extension is 3GP, SDV, ASF, or MP4.)

├── WM\_SYSTEM

└── WM

├── DECOIMG (Folder for Deco-mail pictograms)

├── DUD□□□□

└── DIMGzzzz.### (Extension is JPG, or GIF.)

├── OTHER (Folder for SD other files)

├── OUD□□□□

└── OTHER□□□□.### (Extension is up to three-digit half-pitch alphabets that the FOMA phone cannot recognize.)

├── MOVIE (Folder for PC movie files)

├── MVUD□□□□

└── MOVIE□□□□.### (Extension is WMV, WMA, WVX, WAX, ASF, or ASX.)

├── TABLE (Folder for additional information)

└── MEIGROUP

├── PMC

├── DOCUMENT (Folder for Word, Excel, or PowerPoint files)



├── DOC□□□□

└── DOCDC□□□□.### (Extension is XLS, DOC, or PPT.)

├── TABLE

└── DOCUMENT



 SD\_PIM (Folder for Phonebook entries, schedule events, ToDo items, mail messages, text memos, and bookmarks)  
 PIM▲▲▲▲▲.### (Extension is VCF for Phonebook entries, VCS for schedule events and ToDo items, VMG for mail messages, VNT for text memos, and VBM for bookmarks.)

 SD\_AUDIO (Folder for SD-Audio)

 SD\_BIND (Folder for i-oppli or movable contents)

 SVC▲▲▲▲▲  
 ■■■■■◆◆◆◆◆

△△△: A three-digit half-pitch numeral of 100 through 999 (Use the same numerals for the folder name, and for the file name saved to that folder.)

□□□: A three-digit half-pitch numeral of 001 through 999

◇◇◇: A hexadecimal numeral\* of 001 through FFF using half-pitch numerals of 0 through 9 and half-pitch alphabets of A through F

▲▲▲▲▲: A five-digit half-pitch numeral of 00001 through 65535

■■■■■ and ◆◆◆◆◆: Hexadecimal numerals\* of 0001 through FFFF using half-pitch numerals of 0 through 9 and half-pitch alphabets of A through F

zzzz: A four-digit half-pitch numeral of 0001 through 9999

###: Extension

\*The hexadecimal numerals are carried up every 16, unlike the way the decimal numerals are carried up every 10.

●Using a personal computer, you can write a file name of up to 64 bytes (including extension) of free characters for a PDF file, SD other file, PC movie file, Word file, Excel file and PowerPoint file.

**■ The number of files and time that can be saved to the microSD card**

File	Folder	Number of savable files/time
Still image (DCF standard)	DCIM	See page 132.
Still image (Non-DCF standard)	STILL	Approx. 58,390
Moving image (Movie)	SD_VIDEO	See page 134.
Moving image (Video)	SD_VIDEO	99
Moving image (Non-SD-VIDEO standard)	MMFILE	Approx. 58,390
PC movie file	MOVIE	Approx. 58,390
Melody	RINGER	Approx. 58,390
PDF file	DOCUMENT	Approx. 58,390
Word, Excel, PowerPoint file	PMC	Approx. 58,390
SD-Audio	SD_AUDIO	999

File	Folder	Number of savable files/time
ToruCa file	TORUCA	Approx. 58,390
Deco-mail pictogram	DECOIMG	Approx. 58,390
SD other file	OTHER	Approx. 58,390
Phonebook entry, schedule event, ToDo item, mail message, text memo, bookmark	SD_PIM	Approx. 58,390
i-oppli	SD_BIND	Approx. 58,390
Movable contents	SD_BIND	

- The number of savable files and time for saving vary depending on the memory capacity of the microSD card. You can save more files by adding folders to save files to.
- You might not be able to save the maximum number of files depending on the file size.
- You can check used and unused space of the microSD card by "microSD info".

**Information**



- Folder and file names may be displayed in lowercase characters depending on the personal computer you use.
- When the personal computer is set not to display extensions and hidden folders, change the setting and then operate. For how to change the setting, refer to the instruction manual for your personal computer or Help.
- Do not use the personal computer to delete or move the folders on the microSD card. The microSD card might not be read by FOMA P706iμ.
- You cannot see the files in the "SD\_AUDIO", "SD\_BIND" and "PRG◇◇◇" folders on a personal computer, as they are encrypted.
- When you save data in the "PRG◇◇◇" folder by using a personal computer, you might not be able to delete the video using the FOMA phone.
- When you delete, overwrite, or write a file on a personal computer, ensure that you do not use the same file name you have once used. Even when you have deleted that file, use a different file name.
- On the FOMA phone, you might not be able to display or play back a data item which was saved to the microSD card from other devices. On other devices, you might not be able to display or play back a data item which was saved to the microSD card from the FOMA phone.
- To procure a microSD reader/writer or PC card read adapter, inquire respective manufacturers for the operation of microSD card beforehand.

## Managing Folders

My picture, MUSIC,  motion, Melody, My documents, Kisekai Tool (SD), PC Movie, Document viewer, and SD other files in Data Box manage files in the respective folders.

- See page 345 for folder operations of MUSIC.
- Even when the files in the "Movable contents" folder are listed, the Function menu in the Folder list is displayed.

### Function Menu of the Folder List

Function menu	Operation/Explanation
<b>Add folder</b>	<p>You can create a user folder.</p> <ul style="list-style-type: none"> <li>▶ <b>Enter a folder name.</b></li> <li>• You can enter up to 10 full-pitch/20 half-pitch characters in the FOMA phone.</li> <li>• You can enter up to 31 full-pitch/63 half-pitch characters on the microSD card. You can enter up to 10 full-pitch/20 half-pitch characters for a folder in the "Movable contents" folder.</li> </ul>
<b>Edit folder name</b>	<p>You can edit the name of a user folder, or a folder in the "Decomail-pictograph" folder in the FOMA phone.</p> <ul style="list-style-type: none"> <li>▶ <b>Enter a folder name.</b></li> <li>• You can enter up to 10 full-pitch/20 half-pitch characters in the FOMA phone.</li> <li>• You can enter up to 31 full-pitch/63 half-pitch characters on the microSD card. You can enter up to 10 full-pitch/20 half-pitch characters for a folder in the "Movable contents" folder.</li> </ul>
<b>Delete folder</b>	<p>You can delete a user folder and all files in the folder.</p> <ul style="list-style-type: none"> <li>▶ <b>Enter your Terminal Security Code ▶ YES</b></li> </ul>
<b>Folder security</b> [My picture/  motion]	<p>You can set the folder to open only when you enter your Terminal Security Code.</p> <ul style="list-style-type: none"> <li>▶ <b>Enter your Terminal Security Code ▶ YES</b></li> </ul> <p>The folder changes to ".</p> <ul style="list-style-type: none"> <li>• To release it, perform the same operation.</li> </ul>

Function menu	Operation/Explanation
<b>Delete all image</b> [My picture only]	<p>You can delete all the files in "My picture" and the "Image" folder in "1Seg".</p> <ul style="list-style-type: none"> <li>▶ <b>Enter your Terminal Security Code ▶ YES</b></li> <li>• You cannot delete the pre-installed files. (However, Deco-mail pictograms are deleted.) The files on the microSD card are not deleted, either.</li> </ul>
<b>Edit playlist</b> [Melody only]	<p>You can select up to 10 melodies and program them in order as you like. This is displayed while you are selecting "Playlist".</p> <ul style="list-style-type: none"> <li>▶ <b>Select a playing order from &lt;1st&gt; through &lt;10th&gt;</b></li> <li>▶ <b>Select a folder ▶ Select a melody.</b></li> <li>• To release a programmed melody, select "Release this".</li> <li>▶ <b>Repeat the operations and complete the playlist editing</b></li> <li>▶  <b>Finish</b></li> </ul>
<b>Release playlist</b> [Melody only]	<p>You can release all the programmed melodies from the playlist. This is displayed while you are selecting "Playlist".</p> <ul style="list-style-type: none"> <li>▶ <b>YES</b></li> </ul>
<b>Select storage</b>	<p>You can set the destination folder for when you save the shot still/moving images or the melodies and PDF files obtained by downloading or data communication to the microSD card.</p> <ul style="list-style-type: none"> <li>▶ <b>YES</b></li> </ul>

### Information

#### <Add folder>

- You can add up to 20 folders in the FOMA phone. However, you can add up to 19 folders in the ".
- You cannot add folders on the microSD card in the following cases:
  - When 900 folders are contained in "Picture"
  - When 4,095 folders are contained in "Movie"
  - When 999 folders are contained in "Image Box", "Decomail-pictograph", "Melody", "Other contents", "My documents", "Document viewer", or "SD other files".

## Information

### <Edit folder name>

- You cannot edit the Folder-Security-activated folder name.

### <Delete folder>

- When a melody set for another function is deleted, the setting returns to the default. (When the melody is set for an alarm tone of "Schedule", "ToDo" or "Book program", or for "Alarm", it switches to "Clock Alarm Tone".)





### <Folder security>

- You can set it only for "i-mode", "Camera", "User folder", and "Voice recorder".
- When you select a folder with folder security, the display for entering your Terminal Security Code appears. Enter your Terminal Security Code to temporarily release folder security.

### <Edit playlist>

- If you change or delete the file name, title, or contents of the melody stored in the playlist, all the melodies are released from the playlist.

### <Select storage>

- The following icons are displayed for the folder set as a destination folder:
  - " ... The folders in the "Picture" folder and "Movie" folder
  - " ... The folders in "My documents", "Document viewer", and "SD other files"  
The folders in the "Decomail-pictograph" folder, "Image Box" folder, and "Melody" folder
  - " ... The folders in the "Movable contents" and "Kisekae Tool" folder
  - " ... The folders in the "Other contents" folder
- When you execute Check microSD, or create or edit a folder by using a personal computer, the destination folder on the microSD card might be changed. When the setting is changed, set the destination folder again.

## About Infrared Data Exchange

The FOMA phone conforms to IrMC™ version 1.1 standard.

You can exchange data files with the devices supporting the infrared data exchange function. However, you cannot exchange some files depending on the other party's device.

- The distance for infrared data exchange should be within about 20 cm. Do not move the FOMA phone with the infrared data port pointed to the receiving end until data transfer ends.
- Hold the FOMA phone with your hands securely so that it does not move.
- If you expose the FOMA phone to direct sunlight or put it under fluorescent lights or near an infrared equipment, you may not be able to transmit infrared ray normally due to their influence.
- First set at the receiving end and begin sending data from the sending end within 30 seconds.
- During exchange, the FOMA phone is placed in the same state as it is out of the service area, so you cannot make/receive voice calls or videophone calls, use packet communication such as i-mode or mail, or use data communication.

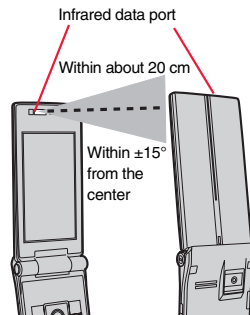

### ■ List of data files you can transfer

Transferable data	Transfer terms	One item	Multiple items	All items
Phonebook (Own number)		○	—	Up to 1,000 items
Schedule*1		○	—	Up to 1,000 items
ToDo		○	—	Up to 100 items
Received mail**2		○	—	Up to 2,500 items
Sent mail		○	—	Up to 1,000 items
Draft mail		○	—	Up to 20 items
Text memo		○	—	Up to 20 items
Melody**3, **4		○	—	—
Still image file**4, **5, **6		○	○	—

Transferable data	Transfer terms	One item	Multiple items	All items
Moving image file	※4, ※7	○	○	—
PDF file	※3, ※4, ※8	○	—	—
ToruCa file	※4	○	○	Up to 495 items
Bookmark (i-mode/Full Browser)	※9	○	—	Up to 100 items each for i-mode and Full Browser

○: Can be transferred    —: Cannot be transferred

※1 You cannot send/receive holidays and anniversaries.

※2 You can send/receive up to 30 Area Mail messages separately. (2,530 messages in total)

※3 You cannot send/receive some files.

※4 The file is sent/received after being converted to the vnt file.

※5 Includes Flash movies.

※6 You cannot send/receive original animations and still images recorded by 1Seg.

※7 You cannot send/receive ASF files and videos recorded by 1Seg.

※8 The i-mode bookmarks may be deleted.

※9 When sending/receiving bookmarks, the folder-sort setting may not be reflected.

#### ■ Storage location and order of received files

	Data	Storage location/Order
Phonebook (Own number)	receive one data	The phone number is stored to the lowest empty memory number in "010" through "999" in the Phonebook. If all memory numbers "010" through "999" are occupied, the phone number is stored to the lowest empty memory numbers in "000" through "009" (2-touch dial).
	receive all data	Stored in the same memory number as that of the sender.
Schedule	receive one data	Stored with the starting date/time of the schedule event.
	receive all data	Stored with the same date and time as those of the sender.
ToDo	receive one data	Stored on the top in the ToDo list.
	receive all data	Stored in the same order as that of the sender.

	Data	Storage location/Order
Received mail	receive one data	Stored in the "Inbox" folder on the Inbox Folder list with the same date and time as that of the sender.
	receive all data	Stored in the same folder as that of the sender with the same date and time.
Sent mail	receive one data	Stored in the "Outbox" folder on the Outbox Folder list with the same date and time as that of the sender.
	receive all data	Stored in the same folder as that of the sender with the same date and time.
Draft mail	receive one data	Stored with the same date and time as that of the sender.
	receive all data	Stored with the same date and time as that of the sender.
Text memo	receive one data	Stored in the first <Not recorded>.
	receive all data	Stored in the same order as that of the sender from the top of the list.
Melody	receive one data	Stored on the top in the "i-mode" folder in "Melody" inside "Data box".
Still Image file	receive one data/ receive multiple data	Stored on the top in the "i-mode" folder in "My picture" inside "Data box".
Moving Image file	receive one data/ receive multiple data	Stored on the top in the "i-mode" folder in "Motion" inside "Data box".
PDF file	receive one data	Stored on the top in the "i-mode" folder in "My documents" inside "Data box".
ToruCa file	receive one data/ receive multiple data	Stored on the top in the "ToruCa" folder.
	receive all data	Stored in the same folder as that of the sender in the same order.
	receive all data	Stored in the same folder as that of the sender in the same order.
Bookmark	receive one data	Stored on the top in the "Bookmark" folder each for i-mode and Full Browser.
	receive all data	Stored in the same folder as that of the sender in the same order.

## Information

- You cannot send the following files:
  - Files whose output from the FOMA phone is prohibited
  - Partially saved files
  - Pre-installed Deco-mail pictures
  - Phonebook entries and SMS messages on the UIM
- You cannot send the files on the microSD card. Copy or move to the FOMA phone and then send.
- You can send/receive up to 9 full-pitch/18 half-pitch characters for a title of a still image, moving image, or PDF file, or up to 31 full-pitch/63 half-pitch characters for a title of a melody.
- When you send a mail message, the file attached to the mail message is also sent. However some files cannot be sent depending on the file type.
- Depending on the mobile phone at the receiving end, subjects of i-mode mail messages cannot be received completely.
- The mail message with an attached file which has not been obtained, or the mail message containing the link information for starting an i-appli program is sent after the file or information is deleted.
- When the maximum number of storable received mail messages (see page 474) is exceeded, the messages are overwritten in the following order; messages in the "Trash box" folder → the oldest received message.
- When the maximum number of storable sent mail messages (see page 474) is exceeded, the oldest unprotected mail message in the Outbox folder is overwritten.
- When you send a ToruCa file (details) using infrared rays, the confirmation display appears asking whether to forward the file including the detailed information. In this case, select "YES" to send it with the detailed information, or select "NO" to send the ToruCa file as a file before obtaining the detailed information.
- The ToruCa file (details) that contains data whose output from the FOMA phone is prohibited is sent as a ToruCa file before obtaining the detailed information.
- You cannot receive Phonebook entries while Restrict Dialing is activated. At sending, you can send only the Phonebook entries set with Restrict Dialing and data of Own Number.
- It may take long to forward data or you might not be able to receive data depending on the data size.
- You cannot store a still image in excess of 2 Mbytes, moving image in excess of 10 Mbytes, melody in excess of 100 Kbytes, PDF file in excess of 2 Mbytes, ToruCa file in excess of 1 Kbyte, or ToruCa file (details) in excess of 100 Kbytes.
- If the FOMA USB Cable with Charge Function 01/02 (option) is connected to the FOMA phone, you may not be able to perform infrared data exchange.
- You cannot send files that are not supported by the device at the receiving end.

## Sending/Receiving One or Multiple Data Files

You can send/receive the data files one by one using infrared rays. You can send/receive multiple still images, moving images, and ToruCa files at a time.



### ■ Notes on sending/receiving

- In Secret Mode, you can send secret data as well. However, in Secret Data Only, you can send only the secret data.
- If you receive a Phonebook entry stored as secret data during Secret Mode or Secret Data Only, the Phonebook entry is stored as an ordinary one.
- When sending a Phonebook entry, you cannot send the stored secret code and voice dial entry.

## Send One or Multiple Data Files

### 1 Display of the data file to be sent (FUNC)

▶ Send Ir data

- To send a Phonebook entry, select "Send Ir data" from the Function menu and select "Send phonebook".
- To send a mail message, ToruCa file or bookmark, select "Ir/  transmission" from the Function menu and select "Send Ir data".
- To send multiple files, select the files you want to send by "Multiple-choice". Press  (FUNC) to select "Send Ir data".

### 2 YES

- To send multiple files, select "YES" by a factor of selected number of files, and send them.

## Receive One or Multiple Data Files

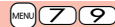



### 1 ▶ LifeKit ▶ Receive Ir data

- You can paste the Ir data receiving function to the desktop. (See page 109)

### 2 Receive ▶ YES

- The confirmation display appears asking whether to continue receiving after receiving one data file. When you received multiple files, select "YES".

**Information**

- When you receive an instruction for starting a software program, and you have already downloaded a compatible software program, that software program starts. If you have not put a check mark for "Ir  appli To" of "Set  appli To", the software program does not start up automatically.

**Sending/Receiving All Data Files**

By using infrared rays, you can collectively send/receive Phonebook entries, schedule events, ToDo items, text memos, bookmarks, mail messages, and ToruCa files.

To send all data files, enter a session number (any four-digit number).

The receiving end needs to enter the same session number.

**■ Notes on sending/receiving all data files**

- Receiving all data files deletes all data you have stored including the secret data and protected data, and the received data overwrites the existing data. The data you have stored in "Secret mode" is deleted as well. Check that no important data is stored before receiving all data files.
- If you send all Phonebook entries, the "Own number" data is also sent. All the data of "Own number" at the receiving end is overwritten except the own number. Mail address is also overwritten by sender's address, so change it at the receiving end.
- Even if you send all Phonebook entries, information of voice dial entries is not sent.
- The Phonebook entries stored as secret data are sent not only during Secret Mode but also any other time. The sent secret data is stored as secret data at the receiving end, too.
- The group names in the Phonebook you have received are stored, so the data set in "Group setting" is also overwritten.
- Note that the schedule events at the receiving end are all deleted if you send all ToDo items to the phone that does not support ToDo.
- You can send/receive the protected sent/received mail messages.

**Send All Data Files**

**1** Display of the data file to be sent  

▶ Send all Ir data ▶ Enter your Terminal Security Code.

- To send the Phonebook entries, select "Send Ir data" from the Function menu and select "Send all phonebook".
- To send mail messages, ToruCa files or bookmarks, select "Ir/  transmission" from the Function menu and select "Send all Ir data".

**2** Enter the session number ▶ YES

- Enter any four-digit number as the session number.

**Receive All Data Files**

**1**  ▶ LifeKit ▶ Receive Ir data

- You can paste the Ir data receiving function to the desktop. (See page 109)

**2** Receive all ▶ Enter your Terminal Security Code  
▶ Enter the same session number as that entered at the sending end ▶ YES ▶ YES

The stored data is deleted, then receiving starts.

**Information**

- When you receive Phonebook entries in which still images are stored or mail to which files are attached, and the multiple same still images or files are found, only one image or file is stored.

## Using Infrared Remote-controller Function

You can use the FOMA phone as a TV remote-controller by starting the **i-oppli** program.

- To use remote-control devices, you may need to download the software program for those devices. [The pre-installed "Gガイド番組表リモコン (G Guide Program List Remote-controller)" supports the infrared remote-controller function.] The key operation for the remote-controller differs depending on the software program.
- This function does not work with some devices.
- Communication might be affected by compatible devices and the ambient light.
- You cannot use the infrared remote-controller during Self Mode.

### Infrared Remote-controller

- Turn the FOMA phone's Infrared data port to the front of a device to be operated. You can operate within about 4 meters away from the device.
- The radiation angle of the infrared rays is within  $\pm 15^\circ$  from the center.

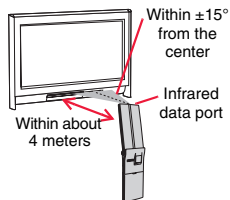

<Forwarding Image>

### Communication Setting

For when you forward Phonebook entries using infrared rays, iC communication, SD-PIM, or DOCOMO keitai datalink, you can specify whether to forward the stored still images together.

- 1 **MENU** ▶ Phonebook ▶ Phonebook settings  
▶ Forwarding image ▶ ON or OFF



<iC Transmission>

## About iC Communication

iC communication is the function that enables you to send/receive data files to/from another FOMA phone using the FeliCa reader/writer function. You can send/receive data files by facing the FeliCa "☞" mark of your FOMA phone toward that of another FOMA phone supporting the iC communication function.

- The type of files and conditions of forwarding are the same as those of infrared data exchange. (See page 317) However, you cannot send multiple files at a time.
- You cannot execute iC communication while "iC card lock" is activated.
- You might have difficulty in sending or receiving files depending on the destination FOMA phone. In that case, move a FeliCa mark "☞" close to or away from the other FeliCa mark or move each side up, down, left, or right.

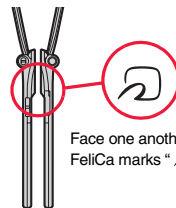

## Sending/Receiving One Data File

You can send/receive the data files one by one using iC communication.

- See "■Notes on sending/receiving" on page 319 as well.

### Send One Data File

- You cannot use this function during charging.

- 1 **Display of the data file to be sent** ▶ **MENU** (FUNC)

▶ **☞ transmission**

- To send a Phonebook entry, select "☞ transmission" from the Function menu and select "Send phonebook".
- To send a mail message, ToruCa file or bookmark, select "Ir/☞ transmission" from the Function menu and select "☞ transmission".

2 **YES**

## Receive One Data File

- You cannot use this function during Multitask.

- Face the FeliCa mark “

## Sending/Receiving All Data Files

By using iC communication, you can collectively send/receive Phonebook entries, schedule events, ToDo items, text memos, bookmarks, mail messages, and ToruCa files.



To send all data files, enter a session number (any four-digit number). The receiving end needs to enter the same session number.

- See  Notes on sending/receiving all data files” on page 320 as well.

## Send All Data Files

- You cannot use this function during charging.

- Display of the data file to be sent ▶  (FUNC)
  - ▶ All  transmission
  - ▶ Enter your Terminal Security Code.

- To send the Phonebook entries, select “ transmission” from the Function menu and select “Send all phonebook”.
- To send mail messages, ToruCa files or bookmarks, select “lr/  transmission” from the Function menu and select “All  transmission”.

- Enter the session number ▶ YES
  - Enter any four-digit number as the session number.

## Receive All Data Files

- You cannot use this function during Multitask.

- Face the FeliCa mark “
  - YES ▶ Enter your Terminal Security Code
    - ▶ Enter the same session number as that entered at the sending end.

The stored data is deleted, and then receiving starts.

### Information

- When you receive Phonebook entries in which still images are stored, and the multiple same still images are found, only one image is stored.

## <Voice Recorder>

### Using Voice Recorder

This function is for recording voices. You can record voices in a meeting instead of taking notes.

- This function is the same as the one for when “Movie type set” is set to “Voice” in Movie Mode.
- You can play back the saved voice from “ motion” of “Data box”.
- See page 133 for the estimate of recordable time.

-  ▶ LifeKit ▶ Voice recorder

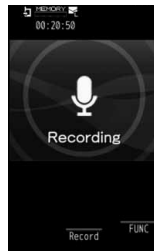

Voice Recorder  
Recording display

- Press  (Record).  
Recording starts.



### 3 Press (Stop).

- Recording ends. The Voice Recorder Saving Pre-check display appears.
- Press  to play back the recorded voice.



### 4 Press (Save).

## Function Menu of the Voice Recorder Recording display

Function menu	Operation/Explanation
<b>File size setting</b>	<p>▶ <b>Select an item.</b></p> <p><b>Mail restrict'n(S)</b> . . . . . You can record up to 500 Kbytes.</p> <p><b>Mail restrict'n(L)</b> . . . . . You can record up to 2 Mbytes.</p> <p><b>Long time</b> . . . . . You can record for a long time. The voice is saved to the microSD card.</p>
<b>Storage setting (Store in)</b>	<p>You can set the storage location for the recorded voice. When you set to "Phone", the voice is saved to "Voice recorder" in the "motion" folder. When you set to "microSD", it is saved to the folder in "Other contents" which you set for "Select storage".</p> <p>▶ <b>Phone or microSD</b></p>
<b>Storage setting (Auto save set)</b>	<p>You can set whether to automatically save the recorded voice after you finish recording.</p> <p>▶ <b>ON or OFF</b></p>
<b>Storage setting (File restriction)</b>	See page 142.
<b>Memory info</b>	You can display the used memory space (estimate)/number of stored items.

## Function Menu of the Voice Recorder Saving Pre-check display

Function menu	Operation/Explanation
<b>Play</b>	See page 323.
<b>Save</b>	See page 323.

Function menu	Operation/Explanation
<b>Attach to mail</b>	<p>You can save the recorded voice and attach it to i-mode mail. Go to step 2 on page 174.</p> <ul style="list-style-type: none"> <li>You can compose it also by pressing  .</li> </ul>
<b>Store in</b>	See page 323.
<b>File restriction</b>	See page 142.
<b>Cancel</b>	You do not save the recorded voice.

<PDF Viewer>

## Displaying PDF Files

You can display the PDF files saved by downloading from sites.

1  ▶ **Data box** ▶ **My documents** ▶ **Select a folder** ▶ **Select a PDF file.**

- Each time you press  from the Folder list, you can switch between the folders in the FOMA phone and the microSD card.
- See page 316 for the Function menu of the Folder list.
- If you cannot display a preview image, any of the following images are displayed:

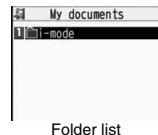

Cannot be displayed



Does not support (PDF file displayed as " " or " ")



Does not support (PDF file displayed as " ")

- See page 161 when the PDF file is set with a password.

## ■ Operations when displaying a PDF file

- See page 324 for when you operate from the Function menu.

Operation	Key operation	Operation	Key operation
Upper scroll		Next page	
Lower scroll		Previous page	
Left scroll		Search	
Right scroll		Search next	
Bring up key operation guide		Search previous	
Zoom in		Bring up bookmark list	
Zoom out		Add bookmark (for at least one second)	
Fit page			

### Information

- When many files are stored in the FOMA phone or the microSD card, it may take long to access them. It may take long to display the PDF file depending on the PDF file.
- Some files might not be correctly displayed.
- When you try to display undownloaded pages while the PDF file partially downloaded is displayed, downloading of the page starts.

## Function Menu of the PDF File List

Function menu	Operation/Explanation
Edit title	See page 283.
Document info	You can display the PDF file name, saved date/time, etc.
Attach to mail	You can compose an i-mode mail message with the PDF files attached. Go to step 2 on page 174. • You can compose it also by pressing  ().
Send Ir data	See page 319.
transmission	See page 321.

Function menu	Operation/Explanation
Copy to microSD	See page 309.
Copy to phone	See page 310.
Copy	See page 284.
Move	See page 284.
Add desktop icon	See page 109.
Delete this	See page 284.
Delete all	See page 284.
Multiple-choice	See page 284.
Memory info	You can display the used memory space (estimate)/number of stored items.
Sort	See page 284.
Listing	You can change the displayed contents of the PDF File list. ▶ <b>Title or Image</b> • You can switch the lists also by pressing  ( from the PDF File list.

### Information



#### <Listing>

- When you use "Image" to display PDF files, they might appear different from the actual images depending on the PDF files.

## Function Menu while PDF File is Displayed

Function menu	Operation/Explanation
Zoom in	You can zoom in the PDF file. You can zoom in the PDF file up to 1,000%.
Zoom out	You can zoom out the PDF file. You can zoom out the PDF file up to 8%.
Go to	You can move to another page of the PDF file. ▶ <b>Select the page you want to move to.</b> • If you select "Specified page", enter the page number you want to move to in the page number field, and select "OK"; then you can access to the specified page.

Function menu	Operation/Explanation
<b>Search</b>	<p>You can display the screen in which the specified character string is contained. The point that matches the specified character is marked in yellow green.</p> <ul style="list-style-type: none"> <li>▶ <b>Search</b> ▶ <b>Select the search string field</b></li> <li>▶ <b>Enter a character string to be searched for.</b></li> <li>• You can enter up to 8 full-pitch/16 half-pitch characters.</li> <li>▶ <b>Put a check mark for search conditions to be specified</b></li> <li>▶  <b>Search</b></li> <li>• If you select "Search prev." or "Search next", you can continue to search under the same condition.</li> </ul>
<b>Bookmark/mark (Disp. bookmark)</b>	See page 326.
<b>Bookmark/mark (Add bookmark)</b>	<p>You can set a bookmark (i-mode bookmark) for the page currently displayed and can display the desired page easily by selecting the bookmark. You can set up to 10 bookmarks.</p> <ul style="list-style-type: none"> <li>▶ <b>Add bookmark</b> ▶ <b>YES</b> ▶ <b>Select the title field</b> ▶ <b>Enter a title</b></li> <li>▶ <b>OK</b></li> <li>• You can enter up to 64 full-pitch/128 half-pitch characters.</li> <li>• See page 327 when bookmarks are stored to the maximum.</li> </ul>
<b>Bookmark/mark (Display mark)</b>	See page 326.
<b>Bookmark/mark (Add mark)</b>	<p>You can store the currently displayed page number and the position within the page as the mark. You can use the stored mark as the sign of the reference point. You can set up to 10 marks.</p> <ul style="list-style-type: none"> <li>▶ <b>Add mark</b> ▶ <b>YES</b></li> <li>• See page 327 when marks are stored to the maximum.</li> </ul>
<b>View types (View mode)</b>	<p>You can change display format of the PDF file.</p> <ul style="list-style-type: none"> <li>▶ <b>View mode</b> ▶ <b>Select a display format.</b></li> <li>• If you select "User defined", enter the magnification value in the magnification specification field, and select "OK"; then you can display the page at the specified magnification.</li> <li>• The magnification you can specify is 8 through 1,000%.</li> <li>• If you save a file after changing the display format, it is displayed at the saved magnification next time.</li> </ul>
<b>View types (Rotate view)</b>	▶ <b>Rotate view</b> ▶ <b>90° to right or 90° to left</b>

Function menu	Operation/Explanation
<b>View types (Page layout)</b>	<p>You can change the display layout of the PDF file.</p> <ul style="list-style-type: none"> <li>▶ <b>Page layout</b></li> <li>▶ <b>Single page, Continuous or Continuous-facing</b></li> </ul>
At Viewer start-up	Single page
<b>View types (Display link)</b>	<p>You can display links set in the PDF file. Internal links (links set in the PDF file displayed), Web To, Mail To, and Phone To/AV Phone To are available for the links.</p> <ul style="list-style-type: none"> <li>▶ <b>Display link</b> ▶ <b>Select a link.</b></li> <li>• When multiple links are found in the display, you can select a link by pressing .</li> <li>• When you select an internal link, you can move to the linked page in the PDF file. See page 164 for another link.</li> </ul>
<b>View types (Page info ON/OFF)</b>	<p>You can set whether to display the zoom magnification, page number, and scroll bar for displaying the PDF file.</p> <ul style="list-style-type: none"> <li>▶ <b>Page info ON/OFF</b> ▶ <b>Select an item</b> ▶ <b>Display or Not display</b></li> </ul>
At Viewer start-up	Display
<b>View types (Document info)</b>	See page 324.
<b>Save</b>	See page 327.
<b>Download remain</b>	<p>You can download all pages of the PDF file which you have not completely downloaded yet such as partially downloaded page by page or failed to be downloaded owing to disconnection of communication midway.</p> <ul style="list-style-type: none"> <li>▶ <b>YES</b></li> </ul>
<b>Capture screen</b>	<p>You can cut out a part of the display and save it as JPEG image.</p> <ul style="list-style-type: none"> <li>▶  <b>Select</b> ▶ <b>YES</b> ▶ <b>Select a folder.</b></li> <li>• See page 163 when images are stored to the maximum.</li> </ul>
<b>Attach to mail</b>	<p>You can compose an i-mode mail message with the PDF files attached.</p> <p>Go to step 2 on page 174.</p>

**Information**

## &lt;Search&gt;

- The search conditions work as shown below:

Match case: Identifies between uppercase and lowercase for search.

Whole words only: Searches for character strings that completely match by unit of a word.

Search upward: When you do "Search next", you can search backwards to the first page from the start page.

Search "?" as wildcard: "?" mark (half-pitch) entered in the search string field is set for a search condition as a random character.

Search in this page: Searches in the currently displayed page only.

## &lt;View types (Page layout)&gt;

- You cannot change the layout of the partial PDF file.

## &lt;Capture screen&gt;

- You might not be able to cut out the display depending on the security setting of the PDF file.

**Display Bookmark**

You can list the bookmarks set for the PDF file and the i-mode bookmarks additionally set.

By selecting a bookmark, you can display the page for which the bookmark is set.

**1** While a PDF file is displayed  (FUNC)

▶ Bookmark/mark ▶ Disp. bookmark

▶ Bookmark or i-mode bookmark ▶ Select a bookmark.

- Some bookmarks that have been set beforehand are categorized into tier-levels. Press  (next) to display the bookmarks at the lower level. However, all the bookmarks at the third-tier level or lower are displayed at the third-tier level.

**Function Menu while i-mode Bookmark is Displayed**

Function menu	Operation/Explanation
Edit title	▶ Enter a title. • You can enter up to 64 full-pitch/128 half-pitch characters.
Delete (Delete)	▶ Delete ▶ YES

Function menu	Operation/Explanation
Delete (Delete selected)	▶ Delete selected ▶ Put a check mark for bookmarks to be deleted ▶  (Finish) ▶ YES
Delete (Delete all)	▶ Delete all ▶ Enter your Terminal Security Code ▶ YES

**Display Mark**

You can list the marked pages and positions stored in the PDF file. When you select a mark, you can display the page in which the mark is stored.

**1** While a PDF file is displayed  (FUNC)  
▶ Bookmark/mark ▶ Display mark ▶ Select a mark.**Function Menu while the Mark List is Displayed**

Function menu	Operation/Explanation
Delete	▶ YES
Delete selected	▶ Put a check mark for marks to be deleted ▶  (Finish) ▶ YES
Delete all	▶ Enter your Terminal Security Code ▶ YES

## Save

You can save the PDF files. You can save the newly downloaded pages and added bookmarks/marks.

You can save up to 3,500 files in total sharing the memory space with other data files, however, the number of files you can save decreases depending on the data volume. (See page 474)

### 1 While a PDF file is displayed ▶ (FUNC) ▶ Save ▶ YES

The PDF file once saved to the FOMA phone or microSD card is overwritten each time you save it. (The operation in step 2 is not required.)

The PDF file that is not saved to the FOMA phone or microSD card is newly saved.

- With the PDF file that was re-downloaded from the first page owing to updating at the server's end, the confirmation display appears asking whether to overwrite the current data. Select "YES" to overwrite it. Select "NO" to newly save.

### 2 Select a destination folder.

- See page 163 when PDF files in the FOMA phone are stored to the maximum.

## When bookmarks or marks are set to the maximum

If you try to add a bookmark or mark to the PDF file for which 10 bookmarks or marks have been set, or if you try to save the PDF file for which 11 or more bookmarks or marks have been set, the confirmation display appears asking whether to add/save the bookmark or mark after unnecessary ones are deleted.

1. YES
2. Select bookmarks/marks to be deleted ▶ YES

or

Put a check mark for bookmarks/marks to be deleted ▶  (Finish) ▶ YES

- Continue putting a check mark until "Finish" appears.

## Document Display Settings

You can set a display format for when the PDF files are displayed from sites.

### 1 ▶ i-mode settings ▶ Doc. display settings ▶ Select a display format.

## <Document Viewer>

# Displaying Word, Excel, and PowerPoint Files

You can display the Microsoft Word, Microsoft Excel and Microsoft PowerPoint files saved to the microSD card. (See page 314)

### ■ Viewable document type

Document type	Extension
Excel	XLS
Word	DOC
PowerPoint	PPT







### 1 ▶ Data box ▶ Document viewer ▶ Select a folder ▶ Select a file.











- See page 316 for the Function menu of the Folder list.



### ■ Operations when displaying a document file

- See page 328 for when you operate from the Function menu.



Operation	Key operation
Upper scroll	
Lower scroll	
Left scroll	
Right scroll	
Bring up key operation guide	
Zoom in	
Zoom out	

Operation	Key operation
Fit page	
Next page	  
Previous page	  
Search	
Search next	
Search previous	

**Information**

- Some files might not be correctly displayed.

**Function Menu of the Document List**

Function menu	Operation/Explanation
<b>Edit title</b>	See page 283.
<b>File info</b>	You can display the name and type of files.
<b>Attach to mail</b>	You can compose an i-mode mail message with the document file attached. Go to step 2 on page 174. <ul style="list-style-type: none"> <li>You can compose it also by pressing  .</li> </ul>
<b>Copy</b>	See page 284.
<b>Move</b>	See page 284.
<b>Delete this</b>	See page 284.
<b>Delete all</b>	See page 284.
<b>Multiple-choice</b>	See page 284.
<b>Memory info</b>	You can display the used memory space (estimate).

**Function Menu while Document File is Displayed**

Function menu	Operation/Explanation
<b>Zoom in</b>	You can zoom in the file. You can zoom in the file up to 1,000%.
<b>Zoom out</b>	You can zoom out the file. You can zoom out the file up to 8%.
<b>View types</b>	You can change display format of the file. <ul style="list-style-type: none"> <li><b>Select a display format.</b></li> <li>If you select "User defined", enter the magnification value in the magnification specification field; then you can display the page at the specified magnification.</li> <li>The magnification you can specify by "User defined" is 8 through 1,000%.</li> </ul>

**Function menu****Operation/Explanation**

<b>Go to</b>	You can move to another page or sheet of the file. <ul style="list-style-type: none"> <li><b>Select the page or the sheet you want to move to.</b></li> <li>If you select "Specified page" for the Microsoft Word file or Microsoft PowerPoint file, enter the page number you want to move to in the page number field; then you can move to the specified page.</li> </ul>
<b>Search</b>	You can display the screen in which the specified character string is contained. The point that matches the specified character string is highlighted. <ul style="list-style-type: none"> <li><b>Search ▶ Select the search string field</b></li> <li><b>Enter a character string to be searched for.</b></li> <li>You can enter up to 8 full-pitch/16 half-pitch characters.</li> <li><b>Put a check mark for search conditions to be specified</b></li> <li> (Search)</li> <li>If you select "Search prev." or "Search next", you can continue to search under the same condition.</li> </ul>
<b>Zoom &amp; page</b>	You can set whether to display the zoom magnification and page number for displaying the file. <ul style="list-style-type: none"> <li><b>Display or Not display</b></li> </ul>
<b>Scroll bar</b>	You can set whether to display the scroll bar for displaying the file. <ul style="list-style-type: none"> <li><b>Display or Not display</b></li> </ul>
<b>Rotate view</b>	<b>▶ 90° to right or 90° to left</b>
<b>Document info</b>	You can display the name and type of files.

**Information****<Search>**

- The search conditions work as shown below:

Whole words only: Searches for character strings that completely match by unit of a word.

Match case: Identifies between uppercase and lowercase for search.

Search in this page (Excel file only): Searches in the currently displayed page only.

Search in this file (Excel file only): Searches in the whole file.

## Printing Saved Images

### Select a Method to Print the Images Saved in the microSD Card

DPOF is the format for recording the print information about the still image you shot with a digital camera. You can input the information into the still image on the microSD card about whether to print it out and how many copies you print out. You can take the card to DPE service shops or use a DPOF compatible printer to print photos as you specify.

**1 Still image in play/Still image list**  

▶ **DPOF setting** ▶ **Print**

▶ **Enter the number of copies to be printed out.**

- Enter "01" through "99" in two digits.
- To cancel printing the selected still image, select "Print OFF". To cancel printing all still images, select "All print OFF".

#### Information

- The classification icon of the images set with DPOF Setting is "".
- You can set DPOF Setting for up to 999 image files.
- You cannot set DPOF Setting for the image in excess of 2 Mbytes or 5M (2592 x 1944) size.
- If unused space on the microSD card is not enough, DPOF Setting might not be set. (The icon and Picture Information, however, indicate DPOF is set.)
- Still images shot by P706iμ also support PRINT Image Matching III.

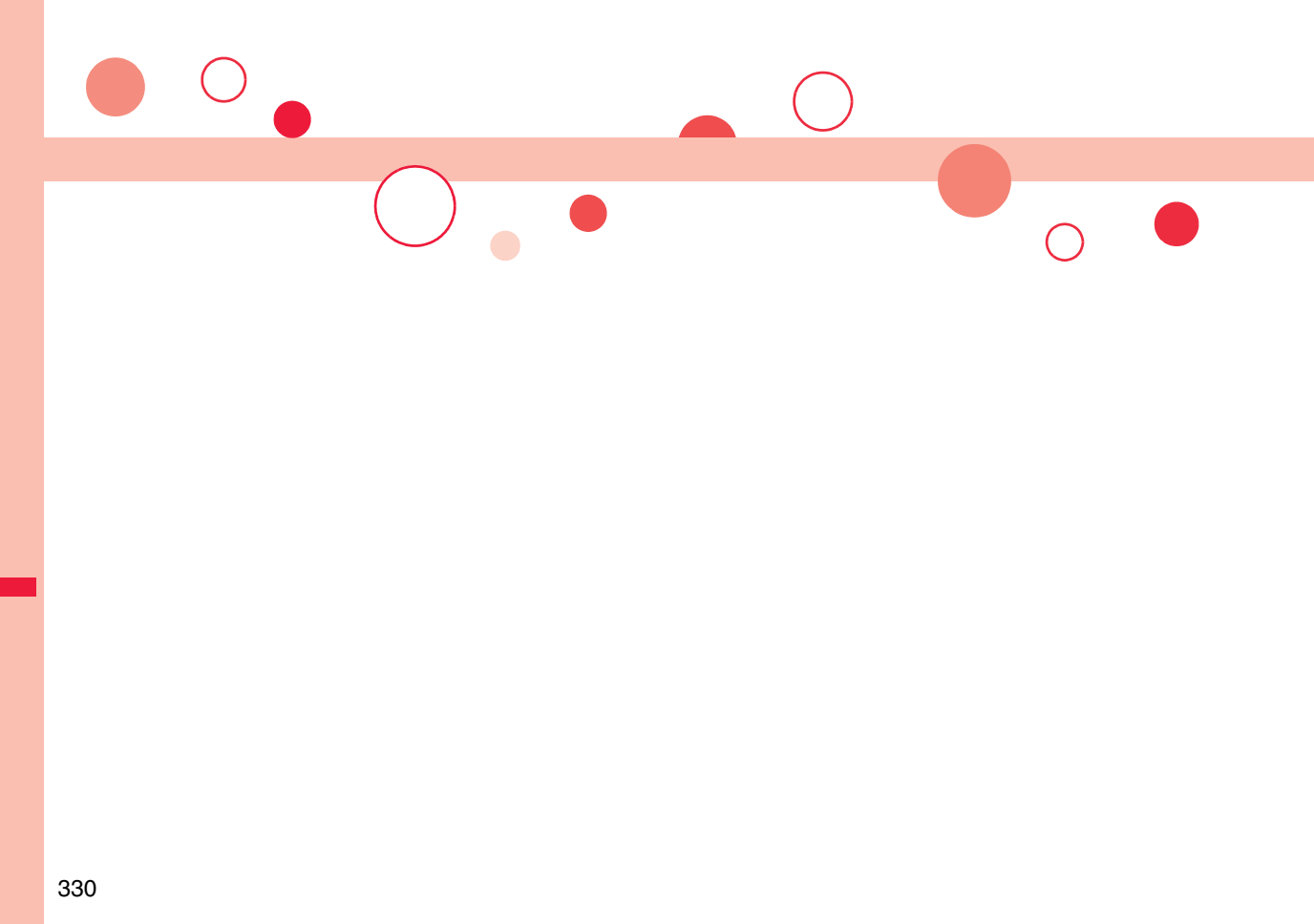



# Music&Video Channel/Music Playback

<b>Music&amp;Video Channel</b>	
What is Music&Video Channel? .....	332
Setting Programs .....	332
Playing Back/Operating Programs .....	334
<b>MUSIC Player</b>	
Playing Back Music .....	338
Saving Music Files .....	338
Using MUSIC Player .....	<MUSIC Player> 340
Using Playlist .....	348

## ■ Handling Music Files

You can use music files saved on the microSD card for personal use only. Before using, give enough consideration not to infringe on the third party's intellectual property rights or other rights such as copyright.

## What is Music&Video Channel?

Music&Video Channel is a service which automatically delivers up to about one-hour programs at night by just setting your favorite music programs in advance. Further, you can enjoy high-quality moving image program of up to about 30 minutes. Programs are updated periodically and you can enjoy the delivered programs at your convenient time such as on commuting.

### ■ Before using Music&Video Channel

- Music&Video Channel is a pay service which is available on a subscription basis. (You need to subscribe to i-mode and Pake-Houdai/Pake-Houdai Full to apply for it.)
- Other than the service fee for using Music&Video Channel, you might be separately charged an information fee depending on the program.
- For the details on Music&Video Channel, refer to "Mobile Phone User's Guide [i-mode] FOMA version".
- If you insert the UIM to the Music&Video Channel incompatible FOMA phone after you subscribe to Music&Video Channel, you cannot use Music&Video Channel Service. Note that the service fee applies unless you cancel the Music&Video Channel subscription.
- You cannot obtain or set programs during international roaming. When you try to obtain or set programs, note that you are charged a packet communication fee for the i-mode communication. Take procedures to halt the distribution of programs before departure to overseas. Then, after homecoming, resume receiving distribution.

## Setting Programs

If you previously set a program that you want to watch, the FOMA phone automatically downloads the program data at night.

### 1 MUSIC ▶ Music&Video Channel



Music&Video Channel display





### 2 Set program ▶ Follow the instructions on the display to set a program.

- For details, refer to "Mobile Phone User's Guide [i-mode] FOMA version".
- See page 163 when data files are stored to the maximum.

### When a program is set

" " appears on the Stand-by display 12 hours before the time the program obtaining starts. However, it does not appear if you have inserted a UIM which is different from the one you used to set the program.



Programs are automatically obtained at night. The display for obtaining programs does not appear but " " appears on the desktop when they are successfully obtained. Press , highlight " ", and press  (Select) to display the Music&Video Channel display.

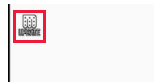

When obtaining fails, " " appears.

## Information

- When the communication is disconnected during obtaining a program, re-obtaining is automatically tried up to five times by an interval of about three minutes. When a display for obtaining a program is shown, however, the confirmation display appears asking whether to re-obtain the program.
- The ring tone does not sound and the vibrator does not work to notify that obtaining programs starts or is completed. When you set "Music&Video ch illum." of "Illumination" to "ON", the Call/Charging indicator flickers when obtaining programs is completed. (See page 105)
- You can set up to two programs at once.
- Note that a newly obtained program overwrites a saved program and you can no longer play back that saved program afterward. To avoid overwriting, perform "Move program" to move the program to the "Saved program" folder.
- You cannot save the obtained program to the microSD card.
- To set programs, you need to register the site which offers Music&Video Channel programs to your My Menu. (See page 154)
- If you have not subscribed to Music&Video Channel, select "About this service" to see the Music&Video Channel introduction page.
- When the programs could not be obtained due to "power off" or "low battery" at the start time of program obtaining, re-obtaining is performed at night of the following day.
- It may take a time to obtain programs, so fully charge the battery and operate in the good radio wave conditions.
- You cannot perform the setting operation and automatic obtaining of the program selected on the Music&Video Channel display or the program in use.
- When you cancel Music&Video Channel, the programs other than those moved by "Move program" are deleted.
- If you insert a UIM which is different from the one you used to set programs, programs cannot be automatically obtained. Set the programs again from the Music&Video Channel display.
- When you select a service menu for Music&Video Channel, the message "Confirm set up information?" appears. If you select "YES", the programs that have been distributed might be deleted. However, they will not be deleted while the distribution is set to be halted.
- If you insert the UIM of the FOMA phone that you have been set for programs into another Music&Video Channel compatible FOMA phone, the programs cannot be obtained automatically. Select "Set program" again from the Music&Video Channel display to automatically update the program setting on the FOMA phone, then the programs can be obtained automatically.

## Check/Cancel the Set Program

### 1 Music&Video Channel display ▶ Set program ▶ Follow the instructions on the display.

You can check or cancel the set program. For details, refer to "Mobile Phone User's Guide [i-mode] FOMA version".

## Information

- Even if the setting of a program is canceled, My Menu is not deleted.

## Obtain a Program Manually

" " appears on the Stand-by display when the automatic program obtaining fails or the program is not updated even after the program distribution date. When the automatic obtaining fails, you can manually obtain the program.

### 1 Music&Video Channel display ▶ Select a program ▶ YES

- For a partially obtained program, select "Play" to play it back.
- For a program which has not been updated, select "Play" to play it back.
- See page 163 when data files are stored to the maximum.

## Information

- When obtaining of a program is suspended, the part of the program obtained up to that point is saved. To obtain remaining part, you can manually obtain it except in some time zones. When a program has been updated or switched to another program, obtaining starts not from the suspended point but from the beginning.
- You cannot re-obtain the program whose playable deadline has expired. Such a program cannot be updated until the next distribution date.
- You may not be able to manually obtain programs depending on the time zone.

## Playing Back/Operating Programs

- You can enjoy playing back programs in stereo sound by connecting the Flat-plug Stereo Earphone Set (option).

### 1 [MENU] ▶ MUSIC ▶ Music&Video Channel

#### ▶ Select a program.

“” is displayed while Music&Video Channel is activated, and “” is displayed when the program shifts to pause state during Play Background.

- When information of the previously played program exists, playback starts from the position and/or in the mode accordingly.
- Highlight a program and press (Chapter); then the Chapter list is displayed.
- Highlight a program and press (To site) to connect to the URL of the program URL information.
- Any of the following images are displayed when you cannot display the preview images:



Cannot be played back



No preview images



Playback restrictions have expired, and the like.



Updating program

- When you or press during playback or pause, playing back program ends.
- You can use mail functions, display sites, and so on, while listening to music using Music&Video Channel (Play Background). (See page 449)

## Operate Music&Video Channel from Data Box

You can play back programs also from Data Box. From Data Box, you can play back currently distributed programs as well as the programs that have been distributed in the past and moved to the “Saved program”.

### 1 [MENU] ▶ Data box ▶ Music&Video Channel

#### ▶ Downloaded program or Saved program

#### ▶ Select a program.

- You can switch display format each time you press (Change) from the Program list.

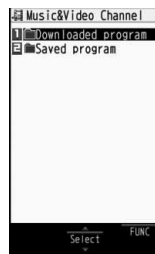

Program Folder list

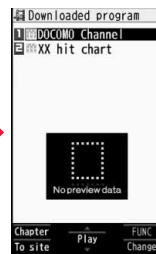

Program list

### ■ About Music&Video Channel Playback display

- Program image or program video  
(When no images are stored, an animation appears.)
- Chapter number/The number of chapters
- Chapter name/Artist name
- Program name
- Playback state
- Playback time/Total playback time
- Play mode (No indication for “Normal”)  
 : Repeat
- Equalizer  
**NORMAL** : Normal  
**S-XBS1** : S-XBS1  
**S-XBS2** : S-XBS2  
**TRAIN** : Train
- Stereo/Monaural  
**STEREO** : Stereo  
**MONO** : Monaural

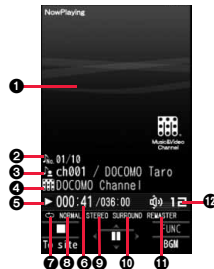

- 10...Listening (No indication for "OFF")  
 : Surround    : Natur1    : Natur2
- 11...Remaster (No indication for "OFF")  
 : ON
- 12...Sound volume
- Operation while playing back a Music&Video Channel program

Operation	Key operation
Halt	
Pause	 •   to play back
Sound volume adjustment	or /
Replay next chapter	or  (for at least one second)
Replay previous chapter	or  (for at least one second) • When playback time is over three seconds or no previous chapter is found, you go back to the beginning of the file.
Search (fast forward)*	Press and hold .
Search (fast rewind)*	Press and hold .
Connect to site	(To site)
Play background	
Display next image	
Display previous image	
Remaster	 • Each time of pressing switches between "ON" and "OFF".
Listening	 • Each time of pressing switches in order of "OFF" → "Surround" → "Natur1" → "Natur2".
Equalizer	 • Each time of pressing switches in order of "Normal" → "S-XBS1" → "S-XBS2" → "Train".

\* You cannot operate during pause.

From the Music&Video Channel Playback display, you can do the following operations by using the switch of the Flat-plug Stereo Earphone Set (option) or the Flat-plug Earphone/Microphone with Switch (option):

- You can operate them when the FOMA phone is closed as well.

Operation	Switch operation
Pause	Press once. • To play back, press again.
Replay next chapter	Press twice in succession.
Replay previous chapter	Press three times in succession. • When playback time is over three seconds or no previous chapter is found, you go back to the beginning of the file.

■ Icons on the Music&Video Channel display/the Program list

The icons on the Music&Video Channel display indicate the download status.



Icon	Description
	Successfully obtained program
	Broken program
	Partially obtained program or unsuccessfully obtained program



- "NEW" is added to the newly obtained program.
- Some programs have restrictions on the number of playbacks, playable deadline, or playback period. "⌚" is added to the icon of the program with playback restrictions and "⌚" is added to the icon of the program with restrictions expired. You can check the playback restrictions for the program by "Program info".
- Some programs have restrictions on operation. "⊘" is added to the icon of the program with operation restrictions.
- Depending on the program, its playable time zone is fixed. "🌐" is added to the icon of the program with time zone restrictions. The time follows the time information obtained from the network.
- When obtaining a periodically-updated program fails, "🔄" appears to tell the program has not been updated. "🔄" disappears when obtaining the program starts.
- The file restriction is set to all the Music&Video Channel programs. See page 142 for the file restrictions.

**Information**

- The information of the previously played program is erased if you do the following operations:
  - When you turn on/off the FOMA phone
  - When you update the program
  - When you delete or move the previously played program
- If you try to play back a program with a low battery, the confirmation display appears asking whether to play it back. The battery alert tone sounds regardless of the setting of "Keypad sound". When the battery becomes low during playback, the playback pauses, and the confirmation display appears asking whether to end the playback.
- In the following cases, playback pauses and resumes after you finish each operation:
  - When you make/receive a voice call or videophone call
  - When you receive a mail message or Message R/F while "Receiving display" is set to "Alarm preferred" or the Stand-by display is shown
  - When an alarm tone of "Alarm", "Schedule", "ToDo", "Book program" or "Timer recording" sounds
 Depending on the function which occurred, the confirmation display might appear asking whether to end the Music&Video Channel program.
- If a black display appears after you play back a program with time zone restrictions, playback starts at the next playable time zone.
- "Program info" of a Music&Video Channel program and deadline information on the display that notifies you of a playable deadline follow the date/time corrected by "Auto time adjust ON". However, even if you set "Summer time" to "ON", they are shown in "OFF" time.
- If you playback a program in countries other than Japan, the playable deadline might expire before or after the displayed deadline.

**Function Menu of Music&Video Channel Display/Program Folder List/Program List**

Function menu	Operation/Explanation
<b>Chapter list</b>	<p>You can display the list of chapters set for the program. Select a chapter to play back the selected chapter and afterward.</p> <ul style="list-style-type: none"> <li>• Press   and select "Chapter info" to display the information about the chapter title, playback time, etc.</li> </ul>

Function menu	Operation/Explanation
<b>Play mode setting</b>	<ul style="list-style-type: none"> <li>▶ <b>Normal or Repeat</b></li> <li><b>Normal</b> . . . Plays back the program once in the order of the chapters.</li> <li><b>Repeat</b> . . . Plays back the program repeatedly in the order of the chapters.</li> </ul>
<b>Program info</b>	You can display the program title, distribution source, playback restrictions, etc.
<b>Move program</b>	<p>Programs currently distributed are updated to new programs on the next distribution date. You can save the current programs by moving them to the "Saved program" folder before the distributed program is updated. You can check "Memory info" for unused memory space you can save to. You can save up to 10 programs sharing the memory space with other data files, however, the number of programs you can save decreases depending on the data volume. (See page 474)</p> <ul style="list-style-type: none"> <li>▶ <b>YES</b></li> <li>• See page 163 when programs are stored to the maximum.</li> </ul>
<b>Add desktop icon</b>	See page 109.
<b>Edit title</b>	<ul style="list-style-type: none"> <li>▶ <b>Enter a title.</b></li> <li>• You can enter up to 31 full-pitch/63 half-pitch characters.</li> </ul>
<b>Reset title</b>	<p>You can reset the title to the default.</p> <ul style="list-style-type: none"> <li>▶ <b>YES</b></li> </ul>
<b>Multiple-choice</b>	<p>You can select and delete multiple programs stored in "Saved program" folder.</p> <ul style="list-style-type: none"> <li>▶ <b>Put a check mark for programs to be deleted</b> ▶  </li> <li>▶ <b>Delete</b></li> </ul>
<b>Connect to URL</b>	<p>You can access the URL when the program has the URL information.</p> <ul style="list-style-type: none"> <li>▶ <b>YES</b></li> </ul>
<b>Display image</b>	<p>You can display the program images stored in the program.</p> <ul style="list-style-type: none"> <li>• Press  to return to the list.</li> </ul>
<b>Memory info</b>	You can display the used memory space (estimate).
<b>Delete/Delete this</b>	<p>You can delete the program.</p> <ul style="list-style-type: none"> <li>▶ <b>YES</b></li> </ul>
<b>Delete all</b>	<p>You can delete all the programs stored in the "Saved program" folder.</p> <ul style="list-style-type: none"> <li>▶ <b>Enter your Terminal Security Code</b> ▶ <b>YES</b></li> </ul>

**Information****<Play mode setting>**

- The playable mode setting is invalid for the programs having the time zone restrictions.
- Even if you set to "Repeat", the program is not played back repeatedly if it has no time zone restrictions but has restrictions on the number of playbacks.

**<Move program>**

- You cannot move the program when its obtaining is not completed, or the move restriction or time zone restriction is set for the program.

**<Edit title>**

- When the next program is delivered, the edited title is overwritten by the new title.

**<Multiple-choice> <Delete/Delete this> <Delete all>**

- Even when you delete the program, the program setting is not released.

**Function Menu during Playback/Pause**

Function menu	Operation/Explanation
<b>Chapter list</b>	See page 336.
<b>Play mode setting</b>	See page 336.
<b>Sound effect (Remaster)</b>	You can bring the sound from an earphone to the original sound by complementing high-pitch range lost at data compression. ▶ <b>Remaster</b> ▶ <b>ON or OFF</b>
<b>Sound effect (Listening)</b>	You can set sound effect for listening. ▶ <b>Listening</b> ▶ <b>Select an item.</b> <b>Surround</b> . . . Makes the sound natural and stereophonic. <b>Natur 1/2</b> . . . Complements the cooped-up feeling specific to earphones and plays back natural sound. Select 1 or 2 according to your taste. <b>OFF</b> . . . . . Sets Listening to "OFF". • "Natur 1/2" is effective for the sound from an earphone.

Function menu	Operation/Explanation
<b>Sound effect (Equalizer)</b>	You can change the quality of the sound from an earphone. ▶ <b>Equalizer</b> ▶ <b>Select an item.</b> <b>Normal</b> . . . . Reproduces normal sound quality. <b>S-XBS1</b> . . . . Enhances bass sound. <b>S-XBS2</b> . . . . Enhances bass sound more deeply than S-XBS1. <b>Train</b> . . . . . Minimizes abnormal sound that causes sound leakage.
<b>Program info</b>	See page 336.
<b>Chapter info</b>	You can display the title, play time, etc. of the chapter currently played back.
<b>Connect to URL</b>	See page 336.
<b>Previous image</b>	You can display a previous image.
<b>Next image</b>	You can display a next image.
<b>Change to full</b>	You can play back the program horizontally with the images rotated in 90 degrees to the right. • When they are already played back horizontally, the vertical display returns.

**Information****<Sound effect>**

- Even if an earphone is not connected, the respective setting contents are displayed on the display.

**<Previous image> <Next image>**

- You can display up to three images, however, you may not be able to display them depending on the program.

**<Change to full>**

- On the full display, you cannot play back the audio-only music programs and video programs of QCIF (176 x 144) size or smaller.
- Depending on the image size, the image might be displayed with the right or bottom side cut.

## Playing Back Music

You can play back music files on your FOMA phone by using MUSIC Player or i-motion player.

### ■MUSIC Player (See page 340)

By "MUSIC Player" of "MUSIC", you can play back Chaku-uta Full® music files or music files saved from music CDs to the microSD card via a personal computer.

### ■i-motion Player (See page 290)

From the "i motion" folder in "Data box", you can play back the voice-only i-motion movie (including music data of AAC format) or AAC format files stored on the microSD card.

- You can display mail, sites, and so on, while listening to music by MUSIC Player (Play Background). (See page 449)

## Saving Music Files



### Download Chaku-uta Full® Music Files

You can download Chaku-uta Full® music files from sites. You can save up to 111.6 Mbytes of files including other data files. (See page 473)

### 1 Bring up a Chaku-uta Full® music file downloadable site▶ Select a Chaku-uta Full® music file▶ Save▶ YES

- Select "Play" to play back the Chaku-uta Full® music file. See page 343 for operations while a Chaku-uta Full® music file is being played back.
- Select "Property" to display the Chaku-uta Full® music file information. (See page 346)
- See page 163 when Chaku-uta Full® music files are stored to the maximum.

### 2 Select a destination folder.

- Press   to display folders at the second-tier level or lower, if they exist. Press  to return to the upper level.

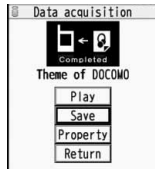

Obtaining Completion display

### When downloading Chaku-uta Full® music file is suspended

When you press  to suspend downloading or when the downloading is suspended by an incoming call, the confirmation display appears asking whether to resume downloading. Select "YES" to resume downloading the remaining part. Select "NO" to show the Obtaining Completion display. Select "Save pt." to save it to a folder in "i-mode" folder in "MUSIC" in "Data box".

You can re-download the rest of the partially saved file from "Data box".

- The title name of the partially saved Chaku-uta Full® music file takes the date and time when it is downloaded.
- When the playable period or playable deadline of the partially saved Chaku-uta Full® music file has expired, you cannot download the remaining segments of the file. Further, the partially saved file is deleted when you save re-obtained data.

### About Uta-hodai

Uta-hodai files are the Chaku-uta Full® music files you can play back just for a period of the contract with a content provider. The playable deadline is specified in the license information that is downloaded together with the music file.

Even when the playable deadline has expired, you can play back the music file by updating the license.

- When a music file (Chaku-uta Full® music file downloaded on the membership service basis) whose playable deadline has expired is found at the start of MUSIC Player, the confirmation display appears asking whether to update the playable deadline. Select "YES" to update the file (Packet communication fee is charged). Select "NO" not to use the music file. See page 340 for starting MUSIC Player.
- Some Uta-hodai music files are applied with surplus playable days even after the playable deadline has passed. During this period, you can play back files without updating the playable deadline information. When the surplus playable days are over, you cannot play back the files. Also if you download a music file with playable period not updated, you cannot play it back before it is saved.
- When the upper limit of the (membership) music services you can register is exceeded, the confirmation display appears asking whether to overwrite them. Select "YES" to overwrite a music service whose playable deadline is the oldest. You can no longer play back the music files downloaded from the overwritten service.
- Packet communication fee charged for updating a playable deadline during international roaming is not supported by Pake-Houdai and Pake-Houdai Full.
- If you insert the UIM with a phone number different from the one you used to download Uta-hodai music files, you cannot download/play back the files. When you use Uta-hodai with a new UIM, execute "Initialize" (see page 373).



## Information

- You can save up to 5 Mbytes per Chaku-uta Full® music file.
- When the Uta-hodai music file set for the ring tone or alarm tone needs to be updated because the playable deadline has expired, the default tone sounds when a call comes in, or an alarm sounds/vibrates.
- For a Chaku-uta Full® music file that has restrictions on the number of playbacks, playable period, or playable deadline, “” is displayed at the head of the title. If you remove the battery and keep it aside for a long time, the date/time information in the FOMA phone might be reset. In that case, you cannot play back the Chaku-uta Full® music file that has restrictions on the playable period or playable deadline. See “Music info” for checking the playback restrictions.
- “Music info” of a Chaku-uta Full® music file and deadline information on the display that notifies you of a playable deadline are shown by the date/time with “Summer time” set to “OFF”.
- Partially saved Chaku-uta Full® music files cannot be played back from Data Box.

## Save WMA Files

You can use Windows Media Player 10/11 to save Windows Media® Audio (WMA) files from a personal computer to the microSD card. You can save up to 600 WMA files.

- As well as music files, you can save playlists, jacket images, and license keys.

### STEP

## 1 Prepare devices required for saving WMA files

First, prepare the devices required for saving WMA files.

- FOMA P706iμ
- microSD card
- FOMA USB Cable with Charge Function 01/02 (option)
- Personal computer with Windows Media Player 10 (10.00.00.3802 or later)/11 installed  
· When you use Windows Media Player 10/11 in Windows XP, use Windows XP Service Pack 2 or later. When you use Windows Vista, use Windows Media Player 11.
- Before connecting the FOMA phone to a personal computer, you need to check the version of Windows Media Player.

### STEP

## 2 Use the FOMA phone as reader/writer

Set “USB mode setting” to “MTP mode”. (See page 313)

### STEP

## 3 Save music files to the microSD card

Start Windows Media Player 10/11 and save WMA files to the microSD card.

- You cannot save WMA files to the FOMA phone.
- For how to operate Windows Media Player 10/11, refer to Help for Windows Media Player 10/11.
- When you finish saving, remove the FOMA USB Cable with Charge Function 01/02 from the FOMA phone.  
When you remove the FOMA USB Cable with Charge Function 01/02, remove it after finishing the software in use.

## About the Napster® Application

You have the ability to save music files using the Napster® application.

- Please download the Napster® application from the following web page:  
<http://www.napster.jp/> (Japanese only)
- If you have any questions about the Napster® application, refer to the following web page:  
<http://www.napster.jp/support/> (Japanese only)

## Information

- Do not remove the microSD card during saving a file. You may lose the file.
- Music files and jacket images are saved to PRIVATE/DOCOMO/MMFILE/WM/ on the microSD card.
- The WMA files saved to the microSD card using another FOMA phone might not be recognized by the FOMA P706iμ. Further, the files might not be recognized by the FOMA P706iμ even when it is connected to the personal computer with “USB mode setting” set to “MTP mode”.  
In that case, delete “WM” folder and “WM-SYSTEM” folder on the microSD card by using your personal computer, or format the microSD card (see page 312). Note that not only music files but also all the other files are deleted when the microSD card is formatted.

**Information**

- When you repeat saving/deleting WMA files to/from the microSD card, the size of license files might become large, and memory space on the microSD card might become small. In this case, you can delete the license files. If you delete the license files, you cannot play back WMA files that require license. To play them back, delete appropriate WMA files as well, connect the FOMA phone to a personal computer and save the WMA files again.
- When unused memory space on the microSD card becomes 300 Kbytes or less, the card might not be recognized by a personal computer. Check the unused memory space on the microSD card, and delete unnecessary data files if the unused memory space is 300 Kbytes or less, then connect to the personal computer after setting "USB mode setting" to "MTP mode".

**Save Music Files by Using SD-Audio**

**By using SD-Jukebox (commercial item), you can save the music files on the music CDs to the microSD card as AAC format data.**

- By using the microSD card adapter (option), you can save music files to the microSD card directly from a personal computer as well.
- ※ The following steps are an example for when the FOMA phone is used as a microSD reader/writer for saving music files.

**About SD-Jukebox**

You can purchase SD-Jukebox from the web page below:  
[http://www.sense.panasonic.co.jp/PanaSense/special/soft/sd\\_jukebox/](http://www.sense.panasonic.co.jp/PanaSense/special/soft/sd_jukebox/) (Japanese only)

- For details about operating environments, refer to the web page below:  
<http://panasonic.jp/support/software/sdjb/> (Japanese only)

**STEP****1 Prepare devices required for saving music files**

**First, prepare the devices required for saving music files.**

- FOMA P706ij
- microSD card
- FOMA USB Cable with Charge Function 01/02 (option)
- Personal computer (Windows XP, Windows 2000, or Windows Vista)
- SD-Jukebox (commercial item)
- Music CD you want to save

**STEP****2 Install SD-Jukebox**

**Install SD-Jukebox on the personal computer.**

**STEP****3 Use the FOMA phone as reader/writer**

**Set "USB mode setting" to "microSD mode". (See page 313)**

**STEP****4 Save music files to the microSD card**

**Start SD-Jukebox and set a music CD on the personal computer. Then use SD-Jukebox to save music files to the microSD card.**

- For how to operate SD-Jukebox, refer to Help for SD-Jukebox.
- When you finish saving, remove the FOMA USB Cable with Charge Function 01/02 from the FOMA phone.

## &lt;MUSIC Player&gt;

**Using MUSIC Player**

**You can play back Chaku-uta Full® music files obtained from sites or music files saved to the microSD card.**

**To play back music files, select "MUSIC Player" from "MUSIC" on Main Menu. Play Background is available so that you can use mail functions, display sites, and so on, while listening to music.**

**To manage folders or data files, select "MUSIC" from "Data box" on Main Menu.**

- Note that battery consumption will be faster when you use MUSIC Player.
- You can enjoy playing back music in stereo sound by connecting the Flat-plug Stereo Earphone Set (option).
- If the number of stored files increases, it may take long to start MUSIC Player.

## Play Back Music Files

### 1 MUSIC MUSIC Player

The Player Menu display appears.

- The playback display (in pause state) of the previously played music file appears when the information about it remains.



### 2 Select an item.

**All tracks** . . . Displays all the music files saved on the FOMA phone and microSD card.

**Artist** . . . . . Displays all the artist names.  
Highlight the name of the artist you want to listen to and press  (Select), then all the album names of the selected artist are displayed. (Go to Album)

**Album** . . . . . Displays all the albums.  
Highlight the name of the album you want to listen to and press  (Select).

**Genre** . . . . . Displays all the genres.  
Highlight the genre you want to listen to and press  (Select).

**Playlist/SD-Audio**  
. . . . . Displays all the playlists created by the FOMA phone and personal computer.  
See page 349 for the playback of playlists.

- The “★” mark is added to the playlist which is being played back or was previously played back.

- When you select “Artist”, “Album”, or “Genre”, and press  (Play) from the Type list, all the music files stored in the selected item are played back.

- You can switch display format each time you press  (Change) from the Music list.

- When “Player” is displayed on the Type list or the Music list, you can display the playback display of previously played back music file or music file in-play by pressing  (Player).

- You might not be able to display all the stored music files depending on their file size.

- The image on the right is displayed when you cannot display a preview image:

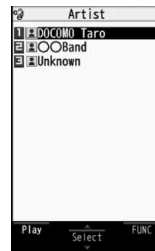

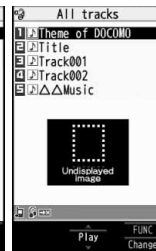

Type list  
(For Artist)



Music list



### 3 Select a music file.

Playback starts from the selected music file in the order listed on the Type list or playlist. “” is displayed while MUSIC Player is activated, and “” is displayed when the music shifts to pause state during Play Background.

- The “★” mark is added to the music file which is currently played back or was previously played back.
- Playback continues even if you close the FOMA phone during playback.
- When you press  (List) during playback, the former Music list is displayed.

## Manage Folders or Music Files

### 1 MENU ▶ Data box ▶ MUSIC

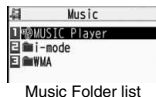

### 2 Select an item.

**MUSIC Player**... MUSIC Player starts. (See page 341)

**i-mode**... Displays the i-mode (Chaku-uta Full®) Folder list. Select a folder.

**WMA**... Displays the WMA list.

Each time you press **MENU** from the i-mode (Chaku-uta Full®) Folder list, you can switch between the folders in the FOMA phone and the microSD card.

You can switch display format each time you press **Change** from the Chaku-uta Full® Music list and WMA list.

See page 341 when you cannot display a preview image.

See page 163 when you select "Search by i-mode".

Some WMA files have playable license (number/period/deadline).

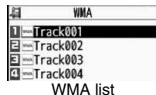
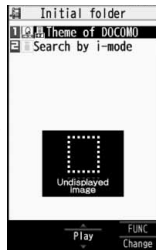
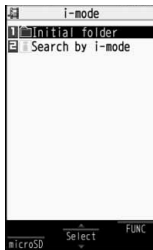

### 3 Select a Chaku-uta Full® music file or WMA file.

Only the selected music file is played back as a demo.

When you close the FOMA phone during playback, the playback stops.

You might be able to play back a Chaku-uta Full® music file by pressing **Play** or selecting "Play" from the Function menu while selecting it on another function.

Chaku-uta Full® music files are shown by titles for control ("Music title - Artist name" in default title) when you display them from the "i-mode" folder. When you operate them from "MUSIC Player", they are shown by titles.

#### About playback display during using MUSIC Player

1 The jacket image which is stored in the music file (When no images are stored, an animation appears.)

2 Track number

3 Title

4 Artist name

5 Playback state

6 Playback time/Total playback time

7 Play mode (No indication for "Normal")

→ : Play only one

↺ : Repeat one

↻ : Repeat all

⊗ : Random

⊞ : Random play & repeat

DEMO : Demo (Displayed only in demo playbacks.)

8 Equalizer

NORMAL : Normal

S-XBS1 : S-XBS1

S-XBS2 : S-XBS2

TRAIN : Train

9 Stereo/Monaural

STEREO : Stereo

MONO : Monaural

10 Listening (No indication for "OFF")

SURROUND : Surround

NATUR1 : Natur1

11 Remaster (No indication for "OFF")

REMASTER : ON

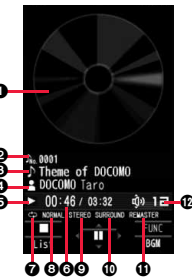

NATUR2 : Natur2

12 Sound volume

## ■ Operations of MUSIC Player in use

Operation	Key operation
Halt	 <ul style="list-style-type: none"> <li>●  to play back</li> </ul>
Pause	 <ul style="list-style-type: none"> <li>●  to play back</li> </ul>
Sound volume adjustment	or
Replay next file	or  (for at least one second)
Replay previous file	or  (for at least one second) <ul style="list-style-type: none"> <li>● When playback time is over three seconds, no previous music file is found, and "Random" or "Random play&amp;repeat" is set, you go back to the beginning of the file.</li> </ul>
Search (fast forward) <sup>※</sup>	Press and hold
Search (fast rewind) <sup>※</sup>	Press and hold
Display list	
Play background	
Display image/ Display lyric	 <ul style="list-style-type: none"> <li>● Each time of pressing switches between Jacket image and lyric image.</li> </ul>
Display next image	
Display previous image	
Remaster	 <ul style="list-style-type: none"> <li>● Each time of pressing switches between "ON" and "OFF".</li> </ul>
Listening	 <ul style="list-style-type: none"> <li>● Each time of pressing switches in order of "OFF" → "Surround" → "Natur1" → "Natur2".</li> </ul>
Equalizer	 <ul style="list-style-type: none"> <li>● Each time of pressing switches in order of "Normal" → "S-XBS1" → "S-XBS2" → "Train".</li> </ul>

※ You cannot operate during halt or pause.

● You cannot use some operations during playback of a demo.

From the playback display during using MUSIC Player, you can operate the following by using the switch of the Flat-plug Stereo Earphone Set (option) or the Flat-plug Earphone/Microphone with Switch (option):

● You can operate them when the FOMA phone is closed as well.

Operation	Switch operation
Pause	Press once. <ul style="list-style-type: none"> <li>● To play back, press again.</li> </ul>
Replay next file	Press twice in succession.
Replay previous file	Press three times in succession. <ul style="list-style-type: none"> <li>● When playback time is over three seconds, no previous music file is found, and "Random" or "Random play&amp;repeat" is set, you go back to the beginning of the file.</li> </ul>

## ■ Playback specifications of Chaku-uta Full<sup>®</sup> music files

File format	MP4
Codec	MPEG-4 AAC MPEG-4 AAC+ (HE-AAC) Enhanced aacPlus
Bit rate	8 to 128 kbps
Extension	3gp

## ■ Playback specifications of SD-Audio files and number of storable files

File format	MPEG-2 AAC, MPEG-2 AAC+SBR
Bit rate	32 to 128 kbps
Maximum number of storable files	999 files
Maximum number of playlist	99 files (Up to 99 files can be stored in a single playlist.) <sup>※</sup>













※ Except "All tracks".

## ■ Playback specifications of WMA files and number of storable files

File format	WMA (Windows Media Audio 9 Standard)
Bit rate	32 to 192 kbps
Maximum number of storable files	Maximum 600 files
Maximum number of playlist	100 files (Up to 250 files can be stored in a single playlist.)



**Icons on the Music list**

When you select a music file from "MUSIC→MUSIC Player", the following icons are displayed:

Icon	Description
	Stored in the FOMA phone
	Stored on the microSD card
	SD-Audio file format
	Chaku-uta Full® file format
	WMA file format
	UIM security function
	Chaku-uta Full® music file with playback restrictions
	Chaku-uta Full® music file with expired playback restrictions
	Playable Uta-hodai music file
	Uta-hodai music file which needs to be updated because the playable deadline has expired
	Unplayable Uta-hodai music file
	File with file restrictions

**Icons on the Chaku-uta Full® Music list**

When you select a Chaku-uta Full® music file from "Data box→MUSIC", the following icons are displayed:

Icon	Audio format	Type
	AAC, AAC+(HE-AAC), Enhanced aacPlus	MP4 file
	—	Partially saved Chaku-uta Full® music files

● Some Chaku-uta Full® music files and Uta-hodai music files have restrictions on the number of playbacks, playable deadline, or playable period. The following icons are added.

- File with playback restrictions . . . . . "⬇"
- File with playback restrictions expired . . . . . "⌚"
- Playable Uta-hodai music file . . . . . "⬆ ⬇"
- Uta-hodai music file which needs to be updated because the playable deadline has expired . . . . . "⬆ ⌚"
- Unplayable Chaku-uta Full® music file or Uta-hodai music file . . . . . "X"

You can check the playback restrictions for the file by "Music info".

● All Chaku-uta Full® music files are set with file restrictions. See page 142 for file restrictions.

Icon	Acquired source
 *	Sites

\* For the copyrighted file movable to the microSD card, "

**Information**

- Even when the file format is supported, you might not be able to play back some files.
- The information of the previously played music file is erased if you do the following operations:
  - When you remove/insert the microSD card
  - When you turn on/off the FOMA phone
  - When you execute "Reset settings" or "Initialize"
  - When you delete the previously played music file
  - When you delete the previously played playlist
  - When you do not insert the microSD card on which the previously played music file is stored
  - When you set "USB mode setting" to "microSD mode" or "MTP mode" and connect to a personal computer
  - When you played back a music file from other than a playlist last time, and then when you perform "Edit music info" or "Reset music info", or when you newly download, save or delete a Chaku-uta Full® music file
  - When the music file previously played is an Uta-hodai music file which needs to be updated because the playable deadline has expired
  - When the previously played music file is a WMA file and when you delete all the WMA licenses
  - When the WMA license becomes invalid
- Partially saved Chaku-uta Full® music files are not displayed when you operate from MUSIC Player.
- Note that the battery is consumed sooner if you perform the fast-forward and other similar operations frequently.

## Information

- In the following cases, the playback pauses and resumes after you finish each operation:
  - When you make/receive a voice call or videophone call
  - When you receive a mail message or Message R/F while "Receiving display" is set to "Alarm preferred" or the Stand-by display is shown
  - When an alarm tone of "Alarm", "Schedule", "ToDo", "Book program" or "Timer recording" sounds
 Depending on the event which occurred, the confirmation display might appear asking whether to end MUSIC Player.
- When a music file is switched to the previous or next one, the music file whose playable deadline or playable period has expired, or WMA file whose WMA license is deleted is skipped. When the Chaku-uta Full® music file has restrictions on the number of playbacks, the confirmation display appears asking whether to play it back regardless of the remaining number of playbacks. However, the music file whose number of playbacks has finished is skipped.

## Function Menu of the Music Folder List/i-mode (Chaku-uta Full®) Folder List/Player Menu Display

Function menu	Operation/Explanation
<b>Play mode setting</b>	▶ <b>Select a play mode.</b>
<b>Normal</b> . . . . .	Plays back the music files sorted by type or in the playlist in order as listed. Finishes after the last music file is played back.
<b>Play only one</b> . . . . .	Plays back the selected music file once.
<b>Repeat one</b> . . . . .	Plays back the selected music file repeatedly.
<b>Repeat all</b> . . . . .	Plays back the music files sorted by type or in the playlist in order as listed repeatedly.
<b>Random</b> . . . . .	Plays back the music files sorted by type or in the playlist at random. Finishes after all the music files are played back.
<b>Random play&amp;repeat</b> . . . . .	Plays back the music files sorted by type or in the playlist at random repeatedly.

Function menu	Operation/Explanation
<b>Add folder</b>	▶ <b>Enter a folder name.</b> <ul style="list-style-type: none"> <li>• You can enter up to 10 full-pitch/20 half-pitch characters.</li> <li>• You can create a total of 25 folders at each level up to the second-tier level in the FOMA phone. You can create folders at each level up to the seventh-tier level on the microSD card.</li> </ul>
<b>Edit folder name</b>	▶ <b>Enter a folder name.</b> <ul style="list-style-type: none"> <li>• You can enter up to 10 full-pitch/20 half-pitch characters.</li> </ul>
<b>Delete folder</b>	You can delete a user folder and all Chaku-uta Full® music files in the folder. ▶ <b>Enter your Terminal Security Code▶ YES</b>
<b>Select storage</b>	You can set the destination folder for when you move the Chaku-uta Full® music file to the microSD card. You can set it for up to seventh-tier-level folders. ▶ <b>YES</b>
<b>Memory info</b>	You can display the used memory space (estimate)/number of stored items.

## Information

### <Add folder>

- You cannot create a user folder in the WMA folder.

### <Delete folder>

- If you delete the Chaku-uta Full® music file set for another function, the setting returns to the default.

### <Select storage>





- "📁" is displayed for the folder set as a destination.
- When you execute Check microSD, or create or edit a folder by using a personal computer, the destination folder on the microSD card might be changed. When the setting is changed, set the destination folder again.

## Function Menu of the Chaku-uta Full® Music List/Type List/ Music List/WMA List

Function menu	Operation/Explanation
<b>Player menu</b>	You can show the Player Menu display from the Type list or Music list.
<b>Play mode setting</b>	See page 345.
<b>Set as ring tone (Fullsong ring tone)</b>	<p>You can set a full piece of Chaku-uta Full® music file as a ring tone.</p> <p>▶ <b>Fullsong ring tone</b> ▶ <b>Select an item.</b></p> <ul style="list-style-type: none"> <li>For a Chaku-uta Full® music file on the microSD card, the confirmation display appears asking whether to move it to the FOMA phone. (See "Move Files from the microSD Card to the FOMA Phone" on page 311.)</li> </ul>
<b>Set as ring tone (Point ring tone)</b>	<p>You can set a part of Chaku-uta Full® music file as a ring tone.</p> <p>▶ <b>Point ring tone</b> ▶ <b>Select a range to be set</b> ▶ <b>Select an item.</b></p> <ul style="list-style-type: none"> <li>You can check the range to be set by pressing (Ⓜ) (Play).</li> <li>For a Chaku-uta Full® music file on the microSD card, the confirmation display appears asking whether to move it to the FOMA phone. (See "Move Files from the microSD Card to the FOMA Phone" on page 311.)</li> </ul>
<b>Music info</b>	<p>You can display the title, artist name, playback time, etc.</p> <ul style="list-style-type: none"> <li>Press (Ⓜ) (FUNC) with the music information of Chaku-uta Full® music file displayed and select "Edit music info"; then you can edit the information contents. Select a desired item and then edit it. To return the edited information to the unedited one, select "Reset music info". Select a desired item and select "YES".</li> </ul>

Function menu	Operation/Explanation
<b>Add to playlist</b>	<p>▶ <b>Select a storing method.</b></p> <p><b>Add one to P-list</b> . . . . . You can store the music file.</p> <p><b>Add some to P-list</b> . . . . . Select the music files to be stored, and press (Ⓜ) (Finish).</p> <ul style="list-style-type: none"> <li>The music files are stored in the displayed order.</li> </ul> <p>▶ <b>Select a playlist you store music files to.</b></p> <ul style="list-style-type: none"> <li>When you create a new playlist to store music files to, select "New playlist" and enter a playlist name. When 30 playlists are already stored, the confirmation display appears asking whether to delete them to save a new one.</li> </ul>
<b>Move</b>	<p>You can move the Chaku-uta Full® music file in the FOMA phone to another folder inside it, or can move the Chaku-uta Full® music file on the microSD card to another folder inside it.</p> <p>▶ <b>Select a destination folder.</b></p> <ul style="list-style-type: none"> <li>Press (Ⓜ) (⏪) to display folders at the second-tier level or lower, if they exist. Press (CLR) to return to the upper level.</li> </ul>
<b>Move to microSD</b>	You can move the Chaku-uta Full® music file to the microSD card. (See page 311)
<b>Move to phone</b>	You can move the Chaku-uta Full® music file on the microSD card to the FOMA phone. (See page 311)
<b>Edit title</b>	<p>You can edit the title of Chaku-uta Full® music file.</p> <p>▶ <b>Enter a title.</b></p> <ul style="list-style-type: none"> <li>For a Chaku-uta Full® music file in the FOMA phone, you can enter up to 9 full-pitch/18 half-pitch characters.</li> <li>For a Chaku-uta Full® music file on the microSD card, you can enter up to 18 full-pitch/36 half-pitch characters.</li> </ul>
<b>Reset title</b>	<p>You can reset the title of a Chaku-uta Full® music file to "Music title - Artist name".</p> <p>▶ <b>YES</b></p>
<b>Add folder</b>	See page 345.
<b>Edit folder name</b>	See page 345.



Function menu	Operation/Explanation
Delete folder	See page 345.
Multiple-choice	You can select multiple Chaku-uta Full® music files and operate them. ▶ Put a check mark for Chaku-uta Full® music files to be operated ▶  (FUNC) ▶ Select an item. Delete . . . See "Delete this" on page 347. Move . . . See page 346.
Connect to URL	You can access the URL when the Chaku-uta Full® music file has the URL information. ▶ YES
Display image	You can display jacket images stored in the music file. • When multiple jacket images are stored, press  to display a previous or next jacket image. • When the image is storable, press  (Save) and select "YES", then select any destination folder to save it.
Display lyric	You can display lyric images stored in the Chaku-uta Full® music file. • When multiple lyric images are stored, press  to display a previous or next lyric image. You can display up to seven lyric images. • When the image is storable, press  (Save) and select "YES", then select any destination folder to save it.
Select storage	See page 345.
Memory info	You can display the used memory space (estimate)/number of stored items.
DEL all licenses	You can delete the WMA license files. ▶ Enter your Terminal Security Code ▶ YES
Delete this	▶ YES
Delete all	You can delete all Chaku-uta Full® music files or WMA files in the folder. ▶ Enter your Terminal Security Code ▶ YES • If there is a user folder in a folder, you cannot delete the user folder or Chaku-uta Full® music files in the user folder.

### Information

#### <Set as ring tone>

- When an Uta-hodai music file set for a ring tone cannot be played back or needs to be updated because playable deadline is expired or the UIM security function is set, the default ring tone returns.
- See "Music info" for checking whether to be set as ring tone.

#### <Add to playlist>

- You cannot add music files to the playlist created using a personal computer.

#### <Reset title>

- If there is no music title or artist name, it is displayed as "Unknown" for each.

#### <Display image>

- Some images may not be displayed correctly.

#### <Delete this> <Delete all>

- If you delete the Chaku-uta Full® music file set for another function, the setting returns to the default.
- If you delete the WMA file stored in the WMA playlist, it is released from WMA playlist.

### Function Menu during Playback/Halt/Pause

Function menu	Operation/Explanation
Player menu	You can show the Player Menu display from the playback display during using MUSIC Player. • Playback state continues even when you show the Player Menu display.
Play mode setting	See page 345.
Sound effect (Remaster)	You can bring the sound from an earphone to the original sound by complementing high-pitch range lost at data compression. ▶ Remaster ▶ ON or OFF

Function menu	Operation/Explanation
<b>Sound effect (Listening)</b>	<p>You can set sound effect for listening.</p> <p>▶ <b>Listening</b> ▶ <b>Select an item.</b></p> <p><b>Surround</b> . . . . Makes the sound natural and stereophonic.</p> <p><b>Natur 1/2</b> . . . . Complements the cooped-up feeling specific to earphones and plays back natural sound. Select 1 or 2 according to your taste.</p> <p><b>OFF</b> . . . . . Sets Listening to "OFF".</p> <ul style="list-style-type: none"> <li>• "Natur 1/2" is effective for the sound from an earphone.</li> </ul>
<b>Sound effect (Equalizer)</b>	<p>You can change the quality of the sound from an earphone.</p> <p>▶ <b>Equalizer</b> ▶ <b>Select an item.</b></p> <p><b>Normal</b> . . . Reproduces normal sound quality.</p> <p><b>S-XBS1</b> . . . Enhances bass sound.</p> <p><b>S-XBS2</b> . . . Enhances bass sound more deeply than S-XBS1.</p> <p><b>Train</b> . . . . . Minimizes abnormal sound that causes sound leakage.</p>
<b>Music info</b>	See page 346.
<b>Connect to URL</b>	See page 347.
<b>Display image/Display lyric</b>	You can display jacket images or lyric images stored in the music file.
<b>Previous image/Previous lyric</b>	You can display a previous jacket image or lyric image.
<b>Next image/Next lyric</b>	You can display a next jacket image or lyric image.

### Information

#### <Sound effect>

- Even if an earphone is not connected, the respective setting contents are displayed on the display.

### Information

<Display image/Display lyric> <Previous image/Previous lyric>  
<Next image/Next lyric>

- For Chaku-uta Full® music files, you can display up to 3 jacket images and up to 7 lyric images.
- For SD-Audio files saved by SD-Jukebox, you can display up to 20 jacket images, and for WMA file, you can display up to 2 image buried in a file. When you use the Napster® application program, you can display 1 image stored as a jacket image. There are no lyric images for them.

## Using Playlist

**You can create the list of music files you want to listen to, and play them back in the order you like.**

**You can play back using the playlists created by the FOMA phone or Windows Media Player, or the SD-Audio playlists created by SD-Jukebox.**

- The maximum number of playlists that can be created and the number of music files that can be stored per playlist are as follows:

Creating source	Number of playlist	Number of music files that can be stored per playlist
Playlists created by FOMA phone	Maximum 30 (Except "All tracks")	100
Playlists created by Windows Media Player	Maximum 100	250
SD-Audio playlists created by SD-Jukebox	Maximum 99 (Except "All tracks")	99

- When you create a playlist on the FOMA phone, you can store the Chaku-uta Full® music files saved on the FOMA phone or microSD card, the WMA files saved by Windows Media Player, and the SD-Audio files saved by SD-Jukebox into the same playlist.

## Icons on the Playlist list

Icon	Type
	All tracks
	All tracks for SD-Audio
	FOMA playlist
	SD-Audio playlist
	WMA playlist

## Create Playlist

### 1 Player Menu display ▶ Playlist/SD-Audio



### 2 (FUNC) ▶ Create playlist ▶ Select a type and display the Music list ▶ Put a check mark for music files to be stored ▶ (Finish)

- The music files are stored in the displayed order.

### 3 Enter a playlist name.

- You can enter up to 18 full-pitch/36 half-pitch characters.

#### Information

- In a playlist, you cannot store partially saved Chaku-uta Full® music files or files with playback restrictions expired.

## Play Back Playlist

### 1 Playlist list ▶ Select a playlist ▶ Select a music file.

- Press (Play) from the Playlist list to play back the music files from the top one in the selected playlist.
- You cannot play back a playlist from "MUSIC" of Data Box.

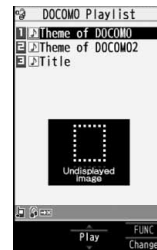

Music list of a Playlist

## Function Menu of the Playlist List

Function menu	Operation/Explanation
Player menu	You can show the Player Menu display.
Play mode setting	See page 345.
Create playlist	See page 349.
Copy playlist	<p>▶ Enter a playlist name.</p> <ul style="list-style-type: none"> <li>• You can enter up to 18 full-pitch/36 half-pitch characters.</li> <li>• When you copy the SD-Audio playlist or WMA playlist, it is copied to the FOMA phone as the FOMA playlist.</li> </ul>
Edit playlist name	<p>You can edit the name of the FOMA playlist.</p> <p>▶ Edit the playlist name.</p> <ul style="list-style-type: none"> <li>• You can enter up to 18 full-pitch/36 half-pitch characters.</li> </ul>
Add	<p>You can add the music files to the FOMA playlist.</p> <p>▶ Select a type and display the Music list</p> <p>▶ Put a check mark for the music files to be added</p> <p>▶  (Finish)</p> <ul style="list-style-type: none"> <li>• The music files are stored at the end of the list in the displayed order.</li> </ul>





Function menu	Operation/Explanation
Delete playlist	<p>You can delete the FOMA playlist.</p> <p>▶ <b>Select a deleting method.</b></p> <p><b>Delete this</b> . . . . . You can delete the playlist.</p> <p><b>Delete selected</b> . . . Select the playlists to be deleted, and press  (<b>Finish</b>).</p> <p><b>Delete all</b> . . . . . Enter your Terminal Security Code.</p> <p>▶ <b>YES</b></p>

### Information

#### <Copy playlist>

- You cannot copy the WMA playlist with no music file stored in.

## Function Menu of the Music List of a Playlist

Function menu	Operation/Explanation
Player menu	<p>You can display the Player Menu display.</p> <ul style="list-style-type: none"> <li>• Playback state continues even when you show the Player Menu display.</li> </ul>
Play mode setting	See page 345.
Music info	See page 346.
Add	See page 349.
DEL from playlist	<p>You can release the music files from the FOMA playlist.</p> <p>▶ <b>Select a deleting method.</b></p> <p><b>DEL one from list</b> . . . . . You can release the music file.</p> <p><b>DEL some from list</b> . . . . . Select the music files to be released, and press  (<b>Finish</b>).</p> <p><b>DEL all from list</b> . . . . . You can delete the whole playlist.</p> <p>▶ <b>YES</b></p>
Order to play	<p>You can change the order of playlist created on the FOMA phone.</p> <p>▶ <b>Select a music file</b> ▶ Use  <b>to change the order to play</b></p> <p>▶  (<b>Select</b>)</p> <ul style="list-style-type: none"> <li>• To change the order in succession, repeat the above steps.</li> </ul> <p>▶  (<b>Set</b>)</p>

Function menu	Operation/Explanation
Add to playlist	See page 346.
Display image	See page 347.
Display lyric	See page 347.

### Information

#### <DEL from playlist>

- You cannot release music files from the playlists created on a personal computer.

# Convenient Functions

Multiaccess . . . . . <Multiaccess>	352	Checking Call Duration and Cost . . . . . <Call Data>	367
Multitask . . . . . <Multitask>	353	Resetting Total Duration/Total Cost . . . . . <Reset Total Cost&Duration>	368
Informing You of an Incoming Call/Mail Message by Voice . . . . . <Reading Aloud>	354	Setting Call Cost Limit. . . . . <Notice Call Cost>	368
Turning Power On/Off Automatically at a Specified Time . . . . . <Auto Power ON/OFF>	356	Using Calculator . . . . . <Calculator>	369
Using Alarm. . . . . <Alarm>	356	Making Text Memos . . . . . <Text Memo>	369
Using Calendar to Manage Schedule . . . . . <Schedule>	359	Copying/Deleting Data Items between FOMA Phone and UIM . . . . . <UIM Operation>	370
Using ToDo to Manage Schedule . . . . . <ToDo>	363	How to Use Flat-plug Earphone/Microphone with Switch . . . . . <Flat-plug Earphone/Microphone with Switch>	371
Setting Operating Conditions of Alarm . . . . . <Alarm Setting>	364	Selecting a Call Destination for when Earphone is Connected . . . . . <Headset Switch to Call>	372
Using Your Original Menu . . . . . <Private Menu Setting>	364	Answering a Call Automatically when Earphone is Connected . . . . . <Auto Answer Setting>	372
Storing Your Name, Mail Address and Other Information . . . . . <Own Number>	365	Resetting Function Settings . . . . . <Reset Settings>	373
Recording Voice during a Call or Standby as Voice Memo . . . . . <Voice Memo during a Call> <Voice Memo>	366	Deleting Stored Data All at Once . . . . . <Initialize>	373
Recording Images during a Videophone Call as a Movie Memo . . . . . <Movie Memo>	367		

<Multiaccess>

## Multiaccess

Multiaccess enables you to simultaneously connect to three lines; a voice call, packet communication, and SMS.

To switch the displays, press and hold **(MULTI)** for at least one second; or press **(MULTI)** to switch from TASK MENU. (See page 354) See page 448 for details on combination of Multiaccess.

Voice call	Single line
i-mode, i-oppli, i-mode mail, packet communication via PC	Single line
SMS	Single line

### Information

- You are charged a fee for each line during Multiaccess.

## Make a Voice Call during i-mode or during Packet Communication

You can make a voice call without disconnecting i-mode or packet communication.

**1** During i-mode or packet communication ▶ **(MULTI)**  
▶ Stand-by display

**2** Make a call.

- If you make a videophone call during i-mode, i-mode is disconnected and the videophone call is made.  
After you finish the videophone call, the i-mode display returns.

## Receive a Voice Call during i-mode or during Packet Communication

You can receive a voice call without disconnecting i-mode or packet communication.

**1** The Call Receiving display appears when a call comes in  
▶ Press  to answer the call.

- To return to the display for i-mode or packet communication without answering the call, press and hold **(MULTI)** for at least one second. Press and hold **(MULTI)** for at least one second again to return to the Call Receiving display. The caller hears not a message but a ringing tone.

## Use Communication during Voice Call

You can use i-mode, send/receive i-mode mail, etc. without disconnecting a voice call.

**1** During a voice call ▶ **(MULTI)** ▶ **(MENU)** **Menu**  
Select an icon to operate each function.

### Information

- When a mail message or Message R/F comes in during a call, the ring tone does not sound and illumination does not flicker regardless of the "Receiving display" setting.
- A ring tone sounds and the Receiving Result display appears when "Receiving display" is set to "Alarm preferred" except for the following cases:
  - During a call
  - While the camera is activated
  - When an i-oppli program set for the Stand-by display is running as an ordinary i-oppli program
- When you perform packet communication via a personal computer, make a call-out operation from the personal computer during a voice call.

<Multitask>

## Multitask

The FOMA phone supports “Multitask” that enables you to use up to three functions such as menu functions (see page 31) at the same time. By combining Multiaccess and Multitask, you can use following functions simultaneously (see page 449 for the combination patterns of Multitask):

### ■ Mail group

i-mode mail and SMS functions

### ■ i-mode group

Menu functions inside “i-mode group” on Main Menu

### ■ Setting group

Menu functions inside “Setting group” on Main Menu

### ■ Tool group

Menu functions inside “Tool group” on Main Menu

### ■ Other functions which do not belong to the groups

Voice call, videophone call, 64K data communication, etc.

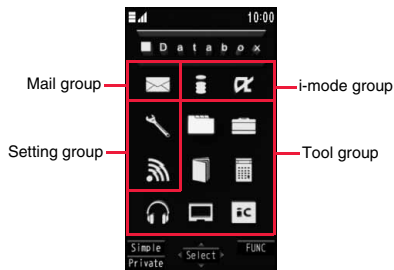

## Start Another Function

### 1 When a function is running ▶ (MULTI) MENU (Menu) ▶ Start another function.

For the icon of the group in use, “▼” or another mark is added.

When a single function is used, “☐” is displayed.

When multiple functions are used, “☐” is displayed.



When a function in the Tool group is running

### If another menu function in the same group has already been called up

The confirmation display appears asking whether to switch the functions. Select “YES” to close the current menu function and the new menu function will be called up.

### Information

- You are charged a call fee even when you are running other functions during a call.
- If a call comes in while another function is working, the call might not be received correctly. In that case, “Record message” or “Call Forwarding Service” may start in a shorter time than the ring time specified for them.
- If you use Multitask to switch functions while executing another function whose load of processing is high, delay may occur in displaying operation, and so on.

## Switch Displays

When multiple menu functions are working, you can switch the displays by pressing and holding **(MULTI)** for at least one second. The display switches from the latest one in chronological order.

### To display the menu list for functions in use

Press **(MULTI)**.

You can switch displays by selecting a function from the list. Select "Open Menu" to show Main Menu, and select "Stand-by display" to show the Stand-by display.

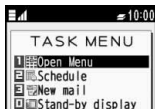

## Information

• Even if you press **(MULTI)** to switch the displays, neither menu function in use is closed nor the call is disconnected. Also, even when you switch the Character Entry display (see page 376) to another menu and use that menu for editing text, you can continue editing the previous text if you switch tasks.

## Exit a Function

To close a menu function, press **(END)** with the menu function displayed.

- Press **(END)** from TASK MENU, and select "YES" to close all menu functions and to return to the Stand-by display.
- When you press **(END)** from the Stand-by display during Play Background, the confirmation display appears asking whether to end the menu function.

## <Reading Aloud>

# Informing You of an Incoming Call/Mail Message by Voice

You can set to be notified of incoming calls by voice instead of a ring tone, or to have the mail contents automatically read aloud. Further, the voice guidance tells you how to operate Voice Dial. This function is available in Japanese only.

## Read Aloud Settings

1 **(MENU)** ▶ Settings ▶ Other settings ▶ Voice settings  
▶ Read aloud settings ▶ ON or OFF ▶ Put a check mark for items to be read aloud ▶ **(Finish)**

- |   |   |
|---|---|
| <b>Voice dial</b> . . . . .               | Instructs you through the Voice Dial operation by voice guidance.   |
| <b>Incoming call</b> . . . . .            | Notifies you of the caller information by voice while a voice call is coming in.  |
| <b>Videophone incoming</b> . . . . .      | Notifies you of the caller information by voice while a videophone call is coming in.   |
| <b>Number of mails/messages</b> . . . . . | Notifies you of the number of mail messages/ Messages R/F by voice at reception. The setting of "Mail/Msg. ring time" is invalid.   |
| <b>Mail list</b> . . . . .                | Reads aloud the sender/destination address and subject on the Inbox/Outbox list.  |
| <b>Displaying mail</b> . . . . .          | Reads aloud the sender/destination address, subject, and text on the detailed mail display. However, the voice guidance is not provided when a melody is automatically played back while "Auto melody play" is set to "ON". |
| <b>Send mail preview</b> . . . . .        | Reads aloud the destination address and text when previewed.  |
- You can stop the voice guidance for a mail message midway by pressing any key. However, it continues if you scroll the display.
  - The voice guidance for a mail message is not provided while the audio from a 1Seg program is played back or when you display a mail message stored on the microSD card.



## Read Aloud Volume

- 1  Settings ▶ Other settings ▶ Voice settings  
▶ Read aloud volume ▶ Use  to adjust the volume.

## Read Aloud Speed

- 1  Settings ▶ Other settings ▶ Voice settings  
▶ Read aloud speed ▶ Select a speed.

## Read Aloud Output

You can set whether to play back the voice guidance from the speaker or hear it from the earpiece.

- 1  Settings ▶ Other settings ▶ Voice settings  
▶ Read aloud output ▶ Speaker or Earpiece

### Information

- The voice guidance of “Incoming call”, “Videophone incoming” and “Number of mails/msgs.” is output from the speaker even when this function is set to “Earpiece”.
- When the Flat-plug Earphone/Microphone with Switch (option) is connected, the voice guidance is output according to the setting of “Headset usage setting”. However, when “Read aloud output” is set to “Earpiece” and “Headset usage setting” is set to “Headset + speaker”, the voice guidance is output from the earphone except for “Incoming call”, “Videophone incoming” and “Number of mails/msgs.”.
- From a Hands-free device, the voice guidance for “Incoming call” and “Videophone incoming” only might be provided.
- You might not be able to stop the voice guidance even by pressing the switch of the Flat-plug Earphone/Microphone with Switch (option).

## Read Aloud Valid Setting

You can set the voice guidance to be provided only when the Flat-plug Earphone/Microphone with Switch (option) is connected.

- 1  Settings ▶ Other settings ▶ Voice settings  
▶ Read aloud valid set. ▶ Normal or Earphone

**Normal** . . . . . Always provides the voice guidance.

**Earphone** . . . . . Provides the voice guidance only when the Flat-plug Earphone/Microphone with Switch is connected.

### Information

- When you set to “Earphone”, the voice guidance continues even if you remove the Flat-plug Earphone/Microphone with Switch during the voice guidance. When a call comes in while the Flat-plug Earphone/Microphone with Switch is removed, the voice guidance does not start even if you connect it.

### Rules of Voice Guidance

The contents of mail messages and others are read aloud generally according to the rules below:

- They may not be read aloud as specified in the following rules depending on the function you use:

#### <Numerics>

- A numeric string up to 16 digits is read aloud as a number. When a numeric string begins with “0” or it is identified as a URL or mail address, it is read aloud digit by digit.
- When numerals are separated by “/” or “.”, they are read aloud as dates.
- “1日” is differently read aloud for the meaning of the date (1st date of a month) and for others. The kanji characters of dates other than “1日” are always read aloud as for the dates.
- When numerals are separated by “:”, they are read aloud as time.
- “-”, “(” and “)” contained in a phone number or zip code are not read aloud, and numbers only are read aloud.
- When a numeric string begins with “¥”, “\$”, “€”, or “£”, it is read aloud as the meaning of money amount. When “,” is used, the numeric string before “,” is identified as money amount and that after “,” is identified as a number, unless it is separated by every three digits.
- “(Numeral) 分の (numeral)” is read as a fraction.

#### <Alphabet>

- Alphabetical letters are read aloud according to the voice guidance dictionary pre-installed in the FOMA phone.
- When a word consists of four or more letters and can be read in romaji-reading, it is read aloud in romaji-reading.
- The alphabetical letters after a numeral might be read aloud as a unit.
- “M”, “T”, “S”, and “H” before a date are converted to the Japanese era name and then read aloud.
- Alphabetical letters other than above are read aloud in alphabetical reading.

**<Symbol>**

- Symbols are read aloud according to the Symbol list. When the same symbol continues three times or more, that symbol is not read aloud.
- “へん/シン” is read aloud for the following character strings: “Re:”, “Re>”, “Re2:”, “Re2>” and “Re2 \*”
- “テン/ソー” is read aloud for the following character strings: “Fw:”, “Fw>”, “Fw2:”, “Fw2>”, “Fw2 \*”, “Fwd:”, “Fwd>”, “Fwd2:”, “Fwd2>” and “Fwd2 \*”
- When symbols for “Reply” or “Forward” are consecutively repeated, they are read aloud only once.

**<Pictograph>**

- Pictographs are read aloud according to the Pictograph list.

**<Smiley>**

- Smileys are read aloud according to the voice guidance dictionary pre-installed in the FOMA phone. When they are identified as a URL or mail address, however, they are read aloud as symbols.

**<Other items>**

- Texts are read aloud separated by punctuation marks and symbols such as “!”, or “?”.
- When the kanji character that expresses the day of the week is put between “(” and “)”, it is read aloud as the day of the week.
- Words should not be correctly read aloud depending on the context of the text (especially place names and proper nouns).

**<Auto Power ON/OFF>****Turning Power On/Off Automatically at a Specified Time**

- 1** **[MENU] ▶ Settings ▶ Clock ▶ Auto power ON/OFF ▶ Auto power ON or Auto power OFF ▶ Select an item.**

**OFF** . . . . . Does not set Auto Power ON/OFF. The setting is completed.

**1 time** . . . . . Sets to turn on/off the power automatically at the specified time only once.

**Daily** . . . . . Sets to turn on/off the power automatically at a specified time everyday repeatedly.

- 2** **Enter a time.**

**Information**

- When you set “Auto power ON” and “Auto power OFF” to the same time, and the specified time arrives, the FOMA phone will turn on if it is turned off, and the FOMA phone will turn off, if it is turned on.

**Information**

- When you set “Auto power OFF” to the same time of an alarm, schedule alarm, or others, those alarms preferentially work.
- Even when you set “Auto power OFF”, the power does not turn off at the specified time if other than the Stand-by display is displayed. The power turns off after the function in working is finished. When you set a Flash movie as the Stand-by display, the power might not be turned off while the Flash movie is moving.
- Turn off the FOMA phone after setting “Auto power ON” to “OFF” when you are near electronic devices using high-precision control or weak signals, or where the use is prohibited such as in airplanes and hospitals.

**<Alarm>****Using Alarm**

You can set Alarm to alert you at the specified time with an alarm tone, animation and illumination. You can store up to 12 alarms.

- 1** **[MENU] ▶ Stationery ▶ Alarm ▶ Highlight an alarm and press [Edit] ▶ Do the following operations.**

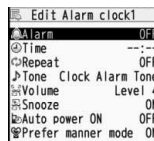

Item	Operation/Explanation
<b>Alarm</b>	You can set whether to validate or invalidate the alarm. ▶ <b>ON or OFF</b>
<b>Time</b>	▶ <b>Enter the time for sounding the alarm.</b> • You cannot set the same time as the time set for the stored alarm.
<b>Repeat</b>	▶ <b>Select a type of repeat.</b> • If you select “Select day”, put a check mark for days of the week to be set and press [Finish].
<b>Tone</b>	▶ <b>Select a type of alarm tone ▶ Select a folder ▶ Select an alarm tone.</b>

Item	Operation/Explanation
<b>Volume</b>	<p>▶ <b>Use  to adjust the volume.</b></p> <ul style="list-style-type: none"> <li>• If you set "Step", the alarm tone is silent for about three seconds, and then the volume steps up every about three seconds, from Level 1 through Level 6.</li> </ul>
<b>Snooze</b>	<p>You can set whether to activate Snooze. If you set to "OFF", set the duration that the alarm tone is to continue sounding.</p> <p>▶ <b>ON or OFF ▶ Enter a ring time (minutes).</b></p> <ul style="list-style-type: none"> <li>• You can enter from "01" through "10" in two digits.</li> <li>• See page 358 for how Snooze works.</li> </ul>
<b>Auto power ON</b>	<p>You can set whether to turn on the power automatically to make an alarm sound when the alarm time arrives during power off.</p> <p>▶ <b>ON or OFF</b></p>
<b>Prefer manner mode</b>	<p>You can set the alarm tone which sounds at the specified time during Manner Mode.</p> <p>▶ <b>ON or OFF</b></p> <p><b>ON . . . . .</b> Sounds at the same volume as set for "Alarm volume" on page 97.</p> <p><b>OFF . . . . .</b> Sounds at the volume set for this function.</p>

## 2 Press (Finish).

- The following icons appear on the display depending on the setting:
  - : Repeats daily.
  - : Repeats on the specified day of the week.

### Function Menu while Alarm is Displayed

Function menu	Operation/Explanation
<b>Edit</b>	Go to step 1 of "Using Alarm" on page 356.
<b>Detail</b>	You can display the stored alarm contents.
<b>Set this</b>	<p>You can validate the stored alarm.</p> <p>▶ <b>YES</b></p> <ul style="list-style-type: none"> <li>• You can validate also by pressing  ().</li> </ul>
<b>Set all</b>	<p>You can validate all the stored alarm.</p> <p>▶ <b>YES</b></p>

Function menu	Operation/Explanation
<b>Release this</b>	<p>You can invalidate the stored alarm.</p> <p>▶ <b>YES</b></p> <ul style="list-style-type: none"> <li>• You can invalidate also by pressing  ().</li> </ul>
<b>Release all</b>	<p>You can invalidate all the stored alarm.</p> <p>▶ <b>YES</b></p>

### Information

- If the alarm tone sounds during a call, press any key to stop it. Once again press any key to end the alarm including Snooze. If the other party on the phone hangs up, an alarm including Snooze ends.
- During a call, the alarm tone sounds at the level set for "Volume" (earpiece volume).
- If any of the following events occurs in Snooze state, Snooze is released:
  - When you receive a voice call or videophone call
  - When you receive a mail message or Message R/F while "Receiving display" is set to "Alarm preferred"
  - When an alarm tone of "Schedule", "ToDo", "Book program" or "Timer recording" sounds
- When you set the power to automatically turn on and an alarm to sound, the default alarm tone sounds if the alarm with the UIM security is selected.
- Turn off the FOMA phone after setting "Auto power ON" to "OFF" when you are near electronic devices using high-precision control or weak signals, or where the use is prohibited such as in airplanes and hospitals.

### When you set an alarm for "Alarm", "Schedule", and "ToDo"

The icon appears on the desktop.

"". . . . . Displayed when an alarm is set for today (except the setting for past time).

"". . . . . Displayed when an alarm is set for tomorrow or onward only.

- If you set "Alarm" of a schedule event/ToDo item to "OFF", the icon is not displayed.

## When the time specified for “Alarm”, “Schedule” or “ToDo” comes

The alarm sounds for about five minutes (in the case of “Alarm”, the alarm sounds for specified time), and illumination lights. The vibrator works as you set for “Phone” of “Vibrator”. The set alarm message and an animation or i-motion movie linking to the selected icon appear on the display.

- If you set “ Snooze ” of Alarm to “ ON ”  
The alarm sounds for about one minute at an interval of five minutes, up to six times, until Snooze is released by pressing .
- During a call  
The alarm sounds from the earpiece three times repeatedly.
- During operations  
The FOMA phone works according to the setting of “Alarm setting”. (See page 364)
- When you set an alarm to the time of another alarm  
The alarm sounds in the priority order of “Alarm”→“Timer recording”→“ToDo”→“Schedule”→“Book program”. A missed schedule event or ToDo is notified by the “Missed alarm” icon.
- When the power is turned off  
<Alarm>  
When “Auto power ON” is set to “ON”, the power automatically turns on to make an alarm notification sound. When the auto-power setting is set to “OFF”, an alarm does not sound with the power stayed off. Even after turning the power on, the “Missed alarm” icon is not displayed.  
<Schedule/ToDo>  
The alarm does not sound.  
The “Missed alarm” icon is not displayed even after turning the power on.
- In Manner Mode  
The vibrator and illumination light notify you. For Schedule/ToDo, a message is also displayed. The alarm sounds at the volume set for Manner Mode. (See page 97)
- During Lock All, Personal Data Lock or Omakase Lock  
The alarm does not sound.  
After releasing each lock, the “Missed alarm” icon is displayed to inform you of the missed alarm. Further, if the power is turned off, the power does not turn on and the “Missed alarm” icon does not appear even after releasing each lock.

- While SD-PIM is activated, during infrared data exchange, or during iC communication  
The alarm does not sound.  
After each function is finished, the “Missed alarm” icon is displayed.
- While resetting settings  
<Alarm>  
The alarm does not sound.  
The “Missed alarm” icon does not appear even after resetting settings is completed.  
<Schedule/ToDo>  
The alarm sounds.
- While updating a software program  
The alarm does not sound.  
The “Missed alarm” icon appears after software updating is completed.

### Information

- If you set “Alarm setting” to “Alarm preferred” and the alarm time has come when you are dialing, the alarm sounds after calling up the other party. If the alarm time has come when receiving a call, the alarm sounds after starting communication.
- You might not be able to set some i-motion movies or Chaku-uta Full<sup>®</sup> music files for the alarm.
- Some i-motion movies set for the alarm might be played back only with sound at the specified time.
- The Chaku-uta Full<sup>®</sup> music file set for the alarm is played back only with sound at the specified time.  
The illumination for when you play back a demo to select an alarm tone might differ from for when you are notified by an alarm.

### To clear alarm tone/alarm message, and animation/i-motion movie from the display

Press any key to stop the alarm tone but the animation/i-motion movie changes to a still image and the alarm message remains displayed. Press any key again (press  if you set “ Snooze ” of Alarm to “ ON ”) to clear the display. However, you cannot clear the alarm message for the schedule event or ToDo item by pressing a side key when the FOMA phone is closed. When a call comes in, the alarm stops sounding.

## When "Alarm" did not work

"Missed alarm" icon is displayed on the desktop. You can check that icon for the contents of the missed alarm (Missed alarm information).

The latest missed alarm information that could not be notified is displayed.

<Schedule>

MENU 4 5

## Using Calendar to Manage Schedule

You can display the calendar by month or week to check the stored schedule events.

You can display or store from January 1, 2000 through December 31, 2037.

• See page 358 for how alarm works.

## Store Schedule Events

When the specified date and time come, an alarm tone, an illumination, alarm message (summary or contents of the schedule event) and an animation corresponding to the set icon notify you of the schedule event.

You can store up to 1,000 schedule events.

1 Stationery > Schedule > > Schedule  
▶ Do the following operations.

Item	Operation/Explanation
Edit summary	<ul style="list-style-type: none"><li>▶ Select an icon.</li><li>• When the alarm tone alerts you, the animation corresponding to the selected icon is displayed.</li><li>▶ Enter the summary of the schedule event.</li><li>• You can enter up to 20 full-pitch/40 half-pitch characters.</li><li>• A summary corresponding to the selected icon is entered in advance.</li></ul>

Item	Operation/Explanation
Whole day	<ul style="list-style-type: none"><li>You can set whole day schedule without entering starting and ending date/time.</li><li>▶ OFF or ON<ul style="list-style-type: none"><li>• If you set to "ON", the alarm sounds at 12 a.m.</li></ul></li></ul>
Date (from)	▶ Enter the date and time for starting the schedule.
Date (to)	▶ Enter the date and time for ending the schedule.
Repeat	<ul style="list-style-type: none"><li>▶ Select a type of repeat.</li><li>• If you select "Select day", put a check mark for days of the week to be set and press  (Finish).</li><li>• The item set with repetition is counted as one item.</li></ul>
Alarm	<ul style="list-style-type: none"><li>▶ Select an alarm method.</li><li>ON . . . . . Alerts you at the time of the starting date/time of the schedule event. The setting for alarm notification is completed.</li><li>ON/Set time . . . Alerts you at the time set as the prenotification.</li><li>OFF . . . . . Does not alert. The setting for alarm notification is completed.</li><li>▶ Enter the date and time to be alerted.</li></ul>
Tone	<ul style="list-style-type: none"><li>▶ Select a type of alarm tone ▶ Select a folder</li><li>▶ Select an alarm tone.</li></ul>
Contents	<ul style="list-style-type: none"><li>▶ Enter schedule contents.</li><li>• You can enter up to 256 full-pitch/512 half-pitch characters.</li></ul>

## 2 Press (Finish).

• The following icons appear on the display depending on the setting:

- : Alarm sounds.
- : Repeats daily.
- : Repeats on the specified day of the week.
- : Repeats monthly.
- : Repeats yearly.

## When you attempt to set two schedule events to the same date and time

You can set the schedule events to the same setting time only by a combination of "1 time" and "Daily/Select day/Monthly/Yearly" for "Repeat". When both two events are set to "1 time" or "Daily/Select day/Monthly/Yearly", the confirmation display appears asking whether to overwrite on each.

When one event is set to "1 time" and the other is set to "Daily/Select day/Monthly/Yearly", the confirmation display appears telling that "1 time" has priority.

### Information

- If you enter a date on or after 29th in "Date (from)" and set "Repeat" to "Monthly", the schedule event is set on the last day of the month when the month does not have the specified date.
- If you enter February 29 of the leap year in "Date (from)" and set "Repeat" to "Yearly", the schedule event is set on February 28 when the year is not the leap year.
- For the schedule event stored as secret data, an alarm message is not displayed when the alarm sounds in ordinary mode (other than "Secret mode" and "Secret data only"). An animation for secret data appears.
- During standby, the alarm tone sounds at the level set for "Phone" of "Ring volume". During a call, the alarm tone sounds at the level set for "Volume" (earpiece volume).

## Store Holidays/Anniversaries

You can store up to 100 holidays and anniversaries, respectively. However, you cannot store multiple holidays for the same date.

### 1 Stationery Holiday or Anniversary Do the following operations.

Item	Operation/Explanation
Date setting	Enter the date.
Repeat	Select a type of repeat. • The item set with repetition is counted as one item.
Contents	Enter the contents of the holiday or anniversary. • You can enter up to 10 full-pitch/20 half-pitch characters.

## 2 Press (Finish).

- The holiday () or anniversary () you set is stored.  
: Repeats yearly.

## Check Schedule Events

You can check the details of schedule events, holidays, or anniversaries.

### 1 Stationery Schedule

The Calendar display appears.

- Today and the selected date are highlighted and the number of stored schedule events and the contents of the day are displayed at the bottom of the display.

- Display on the calendar
  - (blue): Schedule set for a.m.
  - (orange): Schedule set for p.m.

- \_\_\_: Schedule continues two days or more
- Holidays are displayed in red, and anniversaries are marked with a red circle.

- If you press (Prev.) or (Next) from the monthly display, the calendar for the pervious or next month is displayed. If you press (Prev.) or (Next) from the weekly display, the calendar for the pervious or next week is displayed.

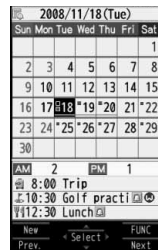

Calendar display (Monthly display)

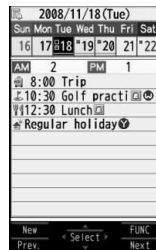

Calendar display (Weekly display)

## 2 Select a date.

The Schedule list for the selected date is displayed.

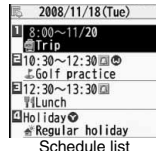

Schedule list

### 3 Select a schedule event, holiday, or anniversary.

Schedule	
Summary	
Golf practice	
Whole day	OFF
Date (from)	
2008/11/18 (Tue)	10:30
Date (to)	
2008/11/18 (Tue)	12:30
Repeat	Weekly
TuWeThSa	
Alarm	Pre-notice
2008/11/18 (Tue)	10:25
Tone	
Lock Alarm Tone	
Detailed Schedule display	

#### Information

- National holidays on the calendar are conformance with "Law on National Holidays and the partially amended version of the Elder Law" (up to No.43, 2005). Spring Equinox Day and Autumn Equinox Day are announced on the official gazette of February 1 in the previous year, therefore, they may differ from the days on the calendar. (As of June 2008)

#### Function Menu of the Calendar Display

Function menu	Operation/Explanation
<b>New</b>	<p>▶ <b>Select an item.</b></p> <p><b>Schedule</b> . . . . . Go to step 1 on page 359.</p> <p><b>Holiday</b> . . . . . Go to step 1 of "Store Holidays/Anniversaries" on page 360.</p> <p><b>Anniversary</b> . . . . . Go to step 1 of "Store Holidays/Anniversaries" on page 360.</p>
<b>Monthly display/ Weekly display</b>	<p>You can switch the Calendar displays.</p> <p>▶ <b>Monthly display or Weekly display</b></p>
<b>Icon display</b>	<p>▶ <b>Select an icon to be displayed.</b></p> <p>The Schedule Event list for the selected icon is displayed.</p> <ul style="list-style-type: none"> <li>Select a schedule event to display the details.</li> </ul>
<b>To specified date</b>	▶ <b>Enter the date.</b>
<b>No. of schedules</b>	<p>You can display the number of schedule events, holidays, and anniversaries. In Secret Mode or Secret Data Only, you can display the number of the schedule events stored as secret.</p>

Function menu	Operation/Explanation
<b>Add desktop icon</b>	See page 109.
<b>Send all Ir data</b>	See page 320.
<b>All transmission</b>	See page 322.
<b>Customize holiday</b>	<p>You can specify the color for the day of the week.</p> <p>▶ <b>Select a day of the week ▶ Default, Red, or Blue</b></p> <ul style="list-style-type: none"> <li>The display color of national holidays and stored holidays has priority over this setting.</li> </ul>
<b>Delete past</b>	<p>You can delete the schedule events, holidays or anniversaries stored for up to a preceding day of the selected day.</p> <p>▶ <b>Select an item to be deleted ▶ YES</b></p>
<b>Delete all</b>	<p>You can delete all the schedule events, holidays or anniversaries.</p> <p>▶ <b>Enter your Terminal Security Code</b></p> <p>▶ <b>Select an item to be deleted ▶ YES</b></p> <ul style="list-style-type: none"> <li>When you delete all holidays, the setting for national holidays will be reset.</li> </ul>
<b>Reset holiday</b>	<p>You can restore the national holidays you deleted to its default. You cannot reset the holidays you have set.</p> <p>▶ <b>YES</b></p>

#### Information

##### <Icon display>

- On the Icon display, the schedule set with repetition is displayed as a single event. For the date, the nearest date of the schedule event is displayed.

##### <Customize holiday>

- Days are displayed in the default color during Lock All, Omakase Lock, and Personal Data Lock.

## Function Menu of the Schedule List/Detailed Schedule Display

Function menu	Operation/Explanation
<b>New</b>	<p>▶ <b>Select an item.</b></p> <p><b>Schedule</b> . . . . . Go to step 1 on page 359.</p> <p><b>Holiday</b> . . . . . Go to step 1 of "Store Holidays/Anniversaries" on page 360.</p> <p><b>Anniversary</b> . . . . . Go to step 1 of "Store Holidays/Anniversaries" on page 360.</p> <ul style="list-style-type: none"> <li>You can store also by pressing  ( <b>New</b> ) from the Schedule list.</li> </ul>
<b>Edit</b>	<p>Go to step 1 on page 359 for the schedule event. Go to step 1 of "Store Holidays/Anniversaries" on page 360 for the holiday and anniversary.</p> <ul style="list-style-type: none"> <li>You can edit also by pressing  ( <b>Edit</b> ) from the detailed Schedule display.</li> <li>You cannot edit national holidays.</li> </ul>
<b>Copy</b>	<p>You can copy the schedule event, holiday or anniversary and store it for another date.</p> <p>▶ <b>Enter the date and time you are pasting to.</b></p> <p>Go to step 1 on page 359 for the schedule event. Go to step 1 of "Store Holidays/Anniversaries" on page 360 for the holiday and anniversary.</p> <ul style="list-style-type: none"> <li>Even if "Repeat" of the copy source is set to "Daily/Select day/Monthly/Yearly", the pasted one is set to "1 time".</li> <li>You cannot copy national holidays.</li> </ul>
<b>Calendar display</b>	You can return to the Calendar display from the Icon display. You can operate this only when the Icon display is displayed.
<b>Icon display</b>	See page 361.
<b>To specified date</b>	See page 361.
<b>Set secret/ Release secret</b>	<p>You can have the schedule event set to or release from secret.</p> <p>▶ <b>YES</b></p> <ul style="list-style-type: none"> <li>When you select "Set secret" in ordinary mode (not in "Secret mode" or "Secret data only"), enter your Terminal Security Code.</li> </ul>

Function menu	Operation/Explanation
<b>Compose message</b>	<p>You can compose an i-mode mail message whose text contains the date and contents of the schedule event.</p> <p>Go to step 2 on page 174.</p>
<b>Attach to mail</b>	<p>You can attach the schedule event to an i-mode mail message to send.</p> <p>Go to step 2 on page 174.</p> <ul style="list-style-type: none"> <li>You can attach it to an i-mode mail message also by pressing  (  ) from the detailed Schedule display.</li> </ul>
<b>Send Ir data</b>	See page 319.
<b>Send all Ir data</b>	See page 320.
<b> transmission</b>	See page 321.
<b>All transmission</b>	See page 322.
<b>Copy to microSD</b>	See page 307.
<b>Delete this</b>	<p>▶ <b>YES</b></p> <ul style="list-style-type: none"> <li>If you delete a schedule event, holiday or anniversary set for repeat, the all data items set for repeat will be deleted.</li> <li>You can delete national holidays only by "Delete this".</li> </ul>
<b>Delete past</b>	See page 361.
<b>Delete select</b>	<p>▶ <b>Put a check mark for schedule events to be deleted</b></p> <p> ( <b>Finish</b> ) ▶ <b>YES</b></p>
<b>Delete all</b>	You can delete all the schedule events, holidays, or anniversaries from the display sorted by "Icon display". (See page 361)



## Using ToDo to Manage Schedule

You can manage your schedule events in the list and make an alarm tone sound when the specified time comes.







You can store up to 100 ToDo items to manage your schedule.

• See page 358 for how alarm works.

### 1 Stationery

**Do the following operations.**

- You can check the stored contents by selecting a stored ToDo item, and you can edit it by pressing .

Item	Operation/Explanation
 <b>Edit ToDo</b>	<p>▶ <b>Enter ToDo contents.</b></p> <ul style="list-style-type: none"> <li>You can enter up to 100 full-pitch/200 half-pitch characters.</li> </ul>
 <b>Due date</b>	<p>▶ <b>Select an item.</b></p> <p><b>Enter date</b> . . . . . Enter the date (due date) directly.</p> <p><b>Choose date</b> . . . . . Select a date (due date) from the calendar. Check the date and press .</p> <p><b>No date</b> . . . . . Does not set the date (due date). The alarm does not work.</p>
 <b>Priority</b>	<p>▶ <b>Select a priority.</b></p> <ul style="list-style-type: none"> <li>If you sort the items in due date order, the items for the same due date are displayed from the higher priority.</li> </ul>
 <b>Category</b>	<p>▶ <b>Select a category.</b></p>
 <b>Alarm</b>	<p>▶ <b>Select an alarm method.</b></p> <p><b>ON</b> . . . . . Alerts you at the set time. The setting for alarm notification is completed.</p> <p><b>ON/Set time</b> . . . Alerts you at the time set as the prenotification.</p> <p><b>OFF</b> . . . . . Does not alert you. The setting for alarm notification is completed.</p> <p>▶ <b>Enter the date and time to be alerted.</b></p>

Item	Operation/Explanation
 <b>Alarm tone</b>	<p>▶ <b>Select a type of alarm tone</b> ▶ <b>Select a folder</b></p> <p>▶ <b>Select an alarm tone.</b></p>



### 2 Press (Finish).

 : Priority high

 : Priority low

- If you do not enter the contents, "Finish" is not displayed, and you cannot store the ToDo item.

## Function Menu while ToDo Item is Displayed

Function menu	Operation/Explanation
<b>New</b>	Go to step 1 on page 363.
<b>Edit</b>	<p>Go to step 1 on page 363.</p> <ul style="list-style-type: none"> <li>To edit "Completion date" of the ToDo item with its "Change status" set to "Completion", select "", and perform the same operation as in "Due date" of step 1 on page 363.</li> </ul>
<b>Change status</b>	<p>The set status icons are displayed on the ToDo list.</p> <p>▶ <b>Select a status.</b></p> <ul style="list-style-type: none"> <li>The status icons switch from blue to red after the due date.</li> <li>If you select "Completion", perform the same operation as in "Due date" of step 1 on page 363.</li> </ul>
<b>Category display</b>	<p>▶ <b>Select a category.</b></p> <ul style="list-style-type: none"> <li>Select a ToDo item to display the details of it.</li> </ul>
<b>Sort/Filter</b>	<p>You can sort ToDo items for display. You can also list them up by the specified status.</p> <p>▶ <b>Select the order or state you want to display.</b></p>
<b>Add desktop icon</b>	See page 109.
<b>Attach to mail</b>	<p>You can attach the ToDo item to an i-mode mail message to send.</p> <p>Go to step 2 on page 174.</p> <ul style="list-style-type: none"> <li>You can attach it to an i-mode mail message also by pressing  () while checking the stored contents of the ToDo item.</li> </ul>
<b>Send Ir data</b>	See page 319.

Function menu	Operation/Explanation
Send all Ir data	See page 320.
transmission	See page 321.
All  transmission	See page 322.
Copy to microSD	See page 307.
Delete this	▶ YES
Delete select	▶ Put a check mark for ToDo items to be deleted ▶  (Finish) ▶ YES
Delete completed	You can delete the "Completion" ToDo items. ▶ YES
Delete all	▶ Enter your Terminal Security Code ▶ YES

### Information

- During standby, the alarm tone sounds at the level set for "Phone" of "Ring volume". During a call, the alarm tone sounds at the level set for "Volume" (earpiece volume).

## <Alarm Setting>

# Setting Operating Conditions of Alarm

You can set whether to make an alarm notification of "Alarm", "Schedule", "ToDo" and "Book program", for when operating another function.

- ▶ Settings ▶ Clock ▶ Alarm setting  
▶ Operation preferred or Alarm preferred

Operation preferred . . . . . Alerts you only during the Stand-by display.

Alarm preferred . . . . . Alerts you even when you are operating the FOMA phone or during a call.

### Information

- When you could not be alerted, the "Missed alarm" icon appears on the desktop.

## <Private Menu Setting>

# Using Your Original Menu

You can store frequently used functions in the Private menu. You can store a total of 12 items from respective functions in Main Menu (see page 422).

## Select a Function from the Private Menu

- ▶ (Private)

Private menu is displayed.

• Press (Set) to display the Private Menu list.

- If you have not touched any key for at least 15 seconds, the Stand-by display returns.

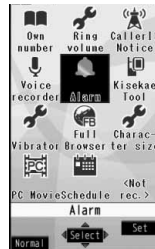

Private menu

- Select an icon.

The display for the selected function is displayed.

## Display the Private Menu List

- ▶ Settings ▶ Display  
▶ Private menu setting



Private Menu list

## Function Menu of the Private Menu List

Function menu	Operation/Explanation
<b>Add to menu</b>	You can store the frequently used function in the Private menu. ▶ <b>Select a function to be stored.</b> • Press  to display the storable functions by main menu item or sub-menu item. Press  to highlight the function you store.
<b>Change BG image</b>	▶ <b>Select a folder</b> ▶ <b>Select an image.</b>
<b>Add desktop icon</b>	See page 109.
<b>Reset menu</b>	You can reset the Private menu to the default. ▶ <b>YES</b>
<b>Release this</b>	▶ <b>YES</b>
<b>Release all</b>	▶ <b>YES</b>

### Information

#### <Change BG image>

- The image you can set is a JPEG or GIF image whose size is Stand-by display (240 x 427) or smaller and up to 300 Kbytes. Perform "Change size" or "Trim away" for other images to set. However, when you set a GIF animation, the first frame is displayed.

<Own Number>



## Storing Your Name, Mail Address and Other Information

In addition to the phone number (own number) you have signed up, you can store your personal information such as your name, reading of your name, phone numbers (up to three), mail addresses (up to three), a postal address, a birthday, memorandums, and a still image.

If you change the mail address or register a secret code, change the mail address in this function as well.

1 ▶ **Phonebook** ▶ **Own number** ▶ **Edit**  
▶ **Enter your Terminal Security Code.**

Perform the operation in step 2 on page 78 to store personal information.

- You cannot change or delete own number.
- If you have already entered your Terminal Security Code by operating another function such as "Display all data", the display for entering your Terminal Security Code does not appear.



2 Press **Finish**.

### Information

- The items other than own number are displayed even if you use another UIM, because they are stored in the FOMA phone.
- The mail address you can change using this function is limited to the mail address displayed by "Own number". You cannot change the actual mail address.

## Function Menu of the Own Number Display

Function menu	Operation/Explanation
<b>Edit</b>	Go to step 1 on page 365.

Function menu	Operation/Explanation
<b>Character size</b>	You can switch character sizes for the Own Number and on the displays within "Phonebook settings", etc. (See "Phonebook" on page 111)
<b>Display all data</b>	You can display all the stored phone numbers and mail addresses. ▶ <b>Enter your Terminal Security Code.</b> Use  to display each item.
<b>Copy name</b>	You can copy a name.
<b>Copy phone number/</b>	You can copy each item.
<b>Copy mail add./</b>	<ul style="list-style-type: none"> <li>The items in the Function menu differ depending on the displayed item.</li> </ul>
<b>Copy address/</b>	
<b>Copy birthday/</b>	
<b>Copy memorandums</b>	
<b>Send Ir data</b>	See page 319. <ul style="list-style-type: none"> <li>You can send data via infrared data exchange also by pressing  (Ir).</li> </ul>
<b>transmission</b>	See page 321. <ul style="list-style-type: none"> <li>You can send data via iC transmission also by pressing  (iCtrans).</li> </ul>
<b>Copy to microSD</b>	See page 307.
<b>Erase phone number/</b>	You can delete each item.
<b>Erase mail add./</b>	
<b>Erase address/</b>	
<b>Erase birthday/</b>	
<b>Erase memorandums/</b>	
<b>Delete image</b>	<ul style="list-style-type: none"> <li>The items in the Function menu differ depending on the displayed item.</li> </ul>
<b>Reset</b>	You can reset (delete) all the stored personal data such as phone numbers or mail addresses except own number. ▶ <b>YES</b> <ul style="list-style-type: none"> <li>When the display for entering your Terminal Security Code appears, enter the code.</li> </ul>
<b>Auto acquire No. B</b>	You can check if the 2in1 service is contracted. When it has been contracted, Number B is stored.

## &lt;Voice Memo during a Call&gt; &lt;Voice Memo&gt;

**Recording Voice during a Call or Standby as Voice Memo**

Two types of Voice Memo are available; one is "Voice memo" (during a call) for recording the other party's voice during a call and the other is "Record voice memo" for recording your own voice during standby. You can record either one of "Voice memo" (during a call) or "Voice memo" for about three minutes.

- See page 70 for playing back/erasing "Voice memo" (during a call) or "Voice memo".

**Record Other Party's Voice during a Call****1 During a voice call**

▶ (for at least one second) or (Memo).

A beep sounds and recording starts.

- To suspend the recording midway, press (Stop) or (CLR), or press and hold (for at least one second).
- Press to end the recording and the call.
- A beep sounds about five seconds before the recording time (for about three minutes) ends.  
The beep sounds twice when the recording ends and the "Talking" display returns.

**Information**

- If you record a voice memo when either "Voice memo" (during a call) or "Voice memo" has already been saved, the old one is overwritten regardless of whether you have played back or not.
- You cannot record a voice memo while operating each item in the Function menu.

**Record Your Voice during Standby**

5 5

**1 ▶ LifeKit ▶ Rec. msg/voice memo ▶ Voice memo ▶ YES**

A beep sounds and recording starts. Speak into the microphone.

- To suspend the recording midway, press (Stop), (CLR) or .
- A beep sounds about five seconds before the recording time (for about three minutes) ends.

The beep sounds twice when the recording ends and the former display returns.

## Information

- The recording is suspended when a call comes in, when an alarm for "Alarm", "Schedule", "ToDo", "Book program", or "Timer recording" sounds, or when you switch the displays by Multitask.

## <Movie Memo>

# Recording Images during a Videophone Call as a Movie Memo



During a videophone call, you can record the receiving images along with voice.

You can record up to five items for about 20 seconds per item.

- See page 70 for playing back/erasing "Movie memo".

## 1 During a videophone call ▶ (for at least one second)

A beep sounds and recording starts. "●REC" is displayed during recording.

- A still image specified by "Movie memo" of "Select image" is shown on the other party's display.
- To suspend the recording midway, press  (Stop) or press and hold  (for at least one second).
- Press  to end the recording and the call.
- A beep sounds about 5 seconds before the recording time (for about 20 seconds) ends.

The beep sounds twice when the recording ends and the "Talking" display returns.

## Information

- If you record a movie memo when five movie memos have already been recorded, the oldest movie memo is overwritten regardless of whether you have played it back or not.
- You cannot record a movie memo while operating each item in the Function menu.

## <Call Data>



# Checking Call Duration and Cost

You can confirm the last and accumulated call duration and cost for voice calls and videophone calls.

- Displayed call duration and cost are for reference and might differ from the actual ones. In addition, the consumption tax is not included in the call cost.
- Both the voice call duration and digital communications duration (videophone call duration + 64K data communication duration) are displayed and both incoming and outgoing calls are included in the duration.
- The call cost is for the outgoing calls only. However, "¥0" or "¥\*: \*" is displayed for toll free calls such as Free Dial or for Directory Assistance Service (104), etc.
- The call cost is accumulated on the UIM. Therefore, when you replace the UIM, the charge accumulated on the UIM in use is displayed. (accumulation from December 2004)  
※ You cannot display the accumulated cost on the UIM using the FOMA phones that were released before the 901i series. (The cost is accumulated on the UIM.)
- You can reset the displayed call duration and call cost.

## 1 ▶ Settings ▶ Call time/cost ▶ Call data

### Last call duration

Talk: Displays the call duration of the latest voice call.

Digital Videophone: Displays the call duration of the latest videophone call.

Non-limiting digital: Displays the call duration of the latest 64K data communication.

### Last call cost

Talk: Displays the call cost for the latest voice call.

Digital Videophone: Displays the call cost for the latest videophone call.

Non-limiting digital: Displays the call cost for the latest 64K data communication.

### Total calls duration

Talk: Displays the call duration of voice calls from the time Reset Total Duration was executed to the current time.

Digital: Displays the call duration of videophone calls and 64K data communication from the time Reset Total Duration was executed to the current time.

### Total calls

Displays the call cost from the time Reset Total Cost was executed to the current call.

#### Calls reset

Displays the date and time when Reset Total Duration was executed last time.

#### Cost reset

Displays the date and time when Reset Total Cost was executed last time.

#### Information

- When Last Call Duration exceeds "19 hours 59 minutes 59 seconds", or Total Calls Duration exceeds "199 hours 59 minutes 59 seconds", "0 s" returns to re-count the time.
- If you switch between the voice call and videophone call during a call, the call duration and call cost are counted respectively for the calls. You are not charged while "Changing" (see page 51) is displayed.
- The duration/charge for i-mode communication and packet communication are not counted. For how to check the i-mode fee, refer to "Mobile Phone User's Guide [i-mode] FOMA version" which is supplied on your i-mode contract.
- The charge for Chaku-moji is not counted.
- The international call fee for using WORLD CALL is counted. The fees for using other international call services are not counted.
- The duration for ringing and calling is not counted as call duration.
- If you turn off the power or remove the UIM, Last Call Duration is reset to "0 s"; and Last Call Cost is reset to "¥\*\*".

#### <Reset Total Cost&Duration>



### Resetting Total Duration/Total Cost

- 1** **Settings** ▶ **Call time/cost** ▶ **Reset total cost&dura.**  
▶ **Enter your Terminal Security Code**  
▶ **Do the following operations.**

Item	Operation/Explanation
<b>Reset total duration</b>	You can reset Last Call Duration and Total Calls Duration to "0 s". ▶ <b>YES</b>
<b>Reset total cost</b>	You can reset Last Call Cost and Total Calls to "¥0". ▶ <b>YES</b> ▶ <b>Enter the PIN2 code.</b> • See page 114 for PIN2 code.

#### <Notice Call Cost>

### Setting Call Cost Limit

You can set the call cost limit for Total Calls and can be notified when it is exceeded. If you set "Auto reset setting" to "ON", the call cost is reset at midnight on the 1st of the month and "0" is deleted.

- 1** **Settings** ▶ **Call time/cost** ▶ **Notice call cost**  
▶ **Enter your Terminal Security Code** ▶ **ON or OFF**  
▶ **Enter a max cost.**
  - You can set from ¥10 through ¥100,000 in unit of ¥10.
- 2** **Select a method to alert** ▶ **ON or OFF**  
▶ **Enter the PIN2 code.**
  - See page 114 for PIN2 code.

#### When Total Calls has exceeded the max cost

"" appears. When "Icon + alarm" is set as a notice method and the Stand-by display returns, the message to the effect that the call cost has exceeded the maximum cost is displayed, and a warning tone sounds from the speakers.

#### Clear Max Cost Icon

You can clear "" displayed by Notice Call Cost.

- 1** **Settings** ▶ **Call time/cost** ▶ **CLR max cost icon**  
▶ **Enter your Terminal Security Code.**

#### Information

- "" is cleared also by executing Reset Total Cost, Reset Settings, or Initialize.
- To be re-notified of the set limit after the maximum cost is exceeded, reset Total Calls.

## Using Calculator

You can display the calculator to make the four rules of calculation (+, -, ×, ÷). You can display up to 10 digits.

- 1 **Stationery** ▶ **Calculator**  
▶ Follow the operation below to make a calculation.

	+		-		×
	-		÷		%
	=				Decimal point
	%				
	CLR	C (Clear): Clears the numeral you have entered last.			
		AC (All clear): Clears all the calculations you entered.			

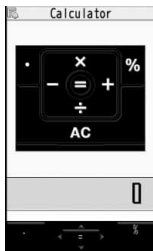

### Information

- You cannot enter a minus sign while you are performing calculation.
- When the calculated result exceeds 10 digits or invalid calculation like "divided by 0" is performed, "E" is displayed.

## Making Text Memos

You can store up to 20 text memos.

- 1 **Stationery** ▶ **Text memo** ▶ **Select <Not recorded>**  
▶ **Enter a text memo.**

- You can enter up to 256 full-pitch/512 half-pitch characters.
- You can check the stored contents by selecting a stored text memo, and you can edit it by pressing (Edit).

## Function Menu while Text Memo is Displayed

Function menu	Operation/Explanation
<b>Edit</b>	Go to step 1 of "Making Text Memos" on page 369.
<b>Compose message</b>	You can compose an i-mode mail message containing the contents of the text memo. Go to step 2 on page 174. • You can compose it also by pressing  (Envelope).
<b>Edit schedule</b>	You can create a schedule event containing the contents of the text memo. ▶ <b>Schedule</b> Go to step 1 on page 359.
<b>Add desktop icon</b>	See page 109.
<b>Send Ir data</b>	See page 319.
<b>Send all Ir data</b>	See page 320.
<b>transmission</b>	See page 321.
<b>All transmission</b>	See page 322.
<b>Copy to microSD</b>	See page 307.
<b>Text memo info</b>	You can display the date and time when the text memo was created, the date and time of the latest update, and the category.
<b>Category</b>	You can classify text memos by category. ▶ <b>Select a category.</b> • If you do not set, the category is set to "None".
<b>Delete this</b>	▶ <b>YES</b>
<b>Delete selected</b>	▶ <b>Put a check mark for text memos to be deleted</b> ▶  (Finish) ▶ <b>YES</b>
<b>Delete all</b>	▶ <b>Enter your Terminal Security Code</b> ▶ <b>YES</b>

## Copying/Deleting Data Items between FOMA Phone and UIM

You can exchange the Phonebook entries or SMS messages between the FOMA phone and the UIM. You can also delete the Phonebook entries or SMS messages stored in the FOMA phone or the UIM. You can save a total of 20 received and sent SMS messages to the UIM.

### Copy/Delete Data Items

#### 1 Phonebook UIM operation Enter your Terminal Security Code.

When you enter your Terminal Security Code, "" appears, and you cannot use phone and mail functions.

- When a call comes in just before entering your Terminal Security Code, UIM Operation ends.

#### 2 Copy or Delete Select a copy end or delete source Phonebook or SMS

##### Phonebook

Search the Phonebook to list the entries.

##### SMS

**Inbox** . . . . Copies or deletes the data in the Inbox.

**Outbox** . . . Copies or deletes the data in the Outbox.

Select a folder and show the list.

- When copying or moving data items to the UIM, the confirmation display appears telling that 2in1 management information will be deleted if 2in1 is activated.

#### 3 Put a check mark for data items to be copied or deleted YES

### Function Menu while the Phonebook List or SMS List is Displayed

Function menu	Operation/Explanation
<b>Start copy/Start deletion</b>	You can start copy or deletion.
<b>Select this</b>	You can select the data item.
<b>Select all in tab</b>	You can select all the Phonebook entries in the displayed tab.
<b>Select all</b>	You can select all data items.
<b>Release this</b>	You can release the selection.
<b>Release all in tab</b>	You can release all the selected Phonebook entries in the displayed tab.
<b>Release all</b>	You can release all selections.
<b>Detail</b>	You can display the detailed Phonebook display or the detailed SMS display.

### Copy from the Function Menu of Phonebook

#### 1 Detailed Phonebook display Copy to UIM or Copy from UIM YES

### Move or Copy from the Function Menu of Mail

#### 1 Outbox list/Detailed Sent Mail display/Inbox list/ Detailed Received Mail display Move/copy UIM operation Select a move method or copy method YES

" (blue)" indicates an SMS message in the FOMA phone.

" " indicates an SMS message on the UIM.

#### Information

- The number of phone numbers/mail addresses you can store in a single Phonebook entry differs between the FOMA phone and the UIM. Therefore, you cannot copy the second or later phone numbers/mail addresses stored in the FOMA phone to the UIM. You cannot copy the data that cannot be stored on the UIM such as a postal address, either.



## Information

- The types of character fonts you can use differ between the FOMA phone and the UIM; therefore a pictograph is converted into a space.
- When you copy Phonebook entries from the FOMA phone to the UIM, the name of up to 10 full-pitch/21 half-pitch characters and the reading of up to 12 half-pitch characters are converted to full-pitch katakana characters and copied. The rest characters are not copied.
- Phonebook entries stored as secret data cannot be copied to the UIM even in Secret Mode or Secret Data Only.
- If you set the same group name in the FOMA phone and the UIM, the group settings for the Phonebook are retained. If you set different group names in the FOMA phone and the UIM, the group settings are not retained.
- You can neither move nor copy SMS reports.
- You cannot protect SMS messages you have moved or copied to the UIM. If you copy or move protected SMS messages to the UIM, SMS messages on the UIM are unprotected. Also, the reply and forward icons become the read icons.
- If SMS messages are moved or copied from the FOMA phone to the UIM, you can check them in the "Inbox" or "Outbox" folder. While you use 2in1, all the SMS messages are saved as the ones for Number A, regardless of the current mode.
- When you move or copy SMS messages from the UIM to the FOMA phone, they are moved or copied to the "Inbox" or "Outbox" folder.

<Flat-plug Earphone/Microphone with Switch>

## How to Use Flat-plug Earphone/ Microphone with Switch

You can make/receive a call by using the Flat-plug Earphone/Microphone with Switch (option).

### Connect Flat-plug Earphone/Microphone with Switch

You need to have the Earphone Plug Adapter for External connector terminal (option) to use the Flat-plug Earphone/Microphone with Switch (option).

Insert the flat plug for the Flat-plug Earphone/Microphone with Switch into the earphone terminal (Flat-plug) and insert the plug for handset side into the connector of the FOMA phone. (See page 26)

## Make Calls Using the Switch

- 1 Enter a phone number**  
or  
bring up a Phonebook entry, redial item, dialed call record, or received call record.
- 2 Press and hold the switch of the Flat-plug Earphone/Microphone with Switch for at least one second**  
▶ Start talking when the other party answers.  
A beep sounds and you are connected.
  - You cannot make a videophone call by pressing the switch of Flat-plug Earphone/Microphone with Switch.
  - You can make a call also by operating the FOMA phone.
- 3 After talking, press and hold the switch of the Flat-plug Earphone/Microphone with Switch for at least one second to end the call.**  
A beep sounds twice and you are disconnected.

## Receive Calls Using the Switch

- 1 During ringing ▶ Press the switch of the Flat-plug Earphone/Microphone with Switch.**  
A beep sounds and you are connected.  
With a videophone call, the image through your camera is sent to the other party. You can switch between that image and the substitute image by pressing  during the videophone call. (See page 72)
  - You can use the switch also with the FOMA phone closed.
  - You can answer calls also by operating the FOMA phone.
  - When "Auto answer setting" is set to "ON", a call is answered automatically after the ring time elapses.
- 2 After talking, press and hold the switch of the Flat-plug Earphone/Microphone with Switch for at least one second to end the call.**  
A beep sounds twice and you are disconnected.

**Information**

- Regardless of the setting for "Keypad sound", a tone for connecting and disconnecting the line sounds.
- Note that you might be connected if you try to connect the Flat-plug Earphone/Microphone with Switch after the ring tone sounds.
- To release hold, press the switch of the Flat-plug Earphone/Microphone with Switch during answer-hold (On Hold) and while a call is on hold (Holding). (When a videophone call is put on hold, the image through your camera is sent and the videophone call starts.)
- Do not press or release the switch of the Flat-plug Earphone/Microphone with Switch in succession. You might be automatically connected.
- If you have signed up for Call Waiting Service and "Multi calling" is displayed during a call, you can switch two calls by pressing and holding the switch of the Flat-plug Earphone/Microphone with Switch for at least one second. However, you cannot use the switch to end the call.
- You can adjust the earpiece volume by pressing (raise) or (lower) during a call.

## &lt;Headset Switch to Call&gt;

**Selecting a Call Destination for when Earphone is Connected**

When "Headset switch to call" is set to "Voice call" and the Stand-by display is shown, you can press the switch of the Flat-plug Earphone/Microphone with Switch (option) to make voice calls.

**1** ► Settings ► Other settings ► Headset switch to call ► Voice call or OFF

- You can check the currently set phonebook entry by pressing (Prev).

**2** Search the Phonebook ► Select a Phonebook entry.

**Information**

- When the Phonebook entry contains multiple phone numbers, the first phone number is set.

**Information**

- If you delete the set Phonebook entry, the Phonebook entry stored in the memory number 999 is automatically set to Headset Switch to Call.

## &lt;Auto Answer Setting&gt;

**Answering a Call Automatically when Earphone is Connected**

If a call comes in while the Flat-plug Earphone/Microphone with Switch (option) is connected, the FOMA phone automatically answers the call after the specified ring time elapses.

**1** ► Settings ► Incoming call ► Auto answer setting ► ON or OFF ► Enter a ring time (seconds).

- Enter from "001" through "120" in three digits.
- You cannot set the same ring time for Auto Answer Setting and Record Message Setting. Set a different time for each.

**Information**

- When the FOMA phone automatically answers a videophone call, a substitute image is sent to the other party. You can switch between the substitute image and the camera image by pressing during the videophone call. (See page 72)
- If you activate Voice Mail Service or Call Forwarding Service together with Auto Answer Setting and want to give priority to Auto Answer Setting over the service, set its ring time shorter than that for Voice Mail Service or Call Forwarding Service.
- Even if you connect the Flat-plug Earphone/Microphone with Switch while ringing, Auto Answer Setting does not work. However, if you disconnect it while ringing, Auto Answer Setting works.
- During 64K data communication, Auto Answer Setting does not work.

<Reset Settings>

MENU 2 3

## Resetting Function Settings

You can reset the items indicated by  of "Function List" to their default. (See page 422)

1  Settings ▶ Other settings ▶ Reset settings  
▶ Enter your Terminal Security Code ▶ YES

### Information

- After you execute "Reset settings", the tickers are not displayed. Then, when the information is automatically updated or you press  to receive the latest information, the tickers automatically flow.

<Initialize>

## Deleting Stored Data All at Once

You can delete the stored data and reset the setting contents of each function to the default.

See "Function List" for the setting at purchase. (See page 422)

- The pre-installed data files are not deleted.
- The pre-installed i- $\alpha$ ppli programs are not deleted.
- The data files stored in the pre-installed i- $\alpha$ ppli programs are deleted. However, the data files stored in Osaifu-Keitai compatible i- $\alpha$ ppli programs are not deleted.
- The protected data files are also deleted.
- All the stored data files are deleted regardless of the mode of 2in1.
- Even if you have deleted the pre-installed data files, they are restored when you execute "Initialize". However, if you delete the pre-installed i- $\alpha$ ppli programs, they are not restored.
- Charge the battery full before initializing the FOMA phone. When the battery level is not enough, you may not be able to initialize the FOMA phone.
- During initialization, never turn off the power of the FOMA phone.
- You cannot use other functions during initialization. Also, you cannot receive calls or mail messages.

1  Settings ▶ Other settings ▶ Initialize  
▶ Enter your Terminal Security Code ▶ YES ▶ YES

When initializing ends, the power automatically turns off and then turns on and the "Initial setting" display appears.

### Information

- You cannot delete the data saved to, stored in, or set for the UIM or the microSD card.
- You cannot delete the setting of data communication set by a personal computer.
- To restore the i- $\alpha$ ppli programs, download them from the "P-SQUARE" site. For downloading, you are charged an additional communication fee.
- After you execute "Initialize", the tickers are not displayed. Then, when the information is automatically updated or you press  to receive the latest information, the tickers automatically flow.
- After you initialize the FOMA phone, you cannot automatically obtain Music&Video Channel programs. Access the Setting Confirmation display from the Music&Video Channel menu to reflect the program setting.
- Initialization may take a while if the data to be deleted is bulky.

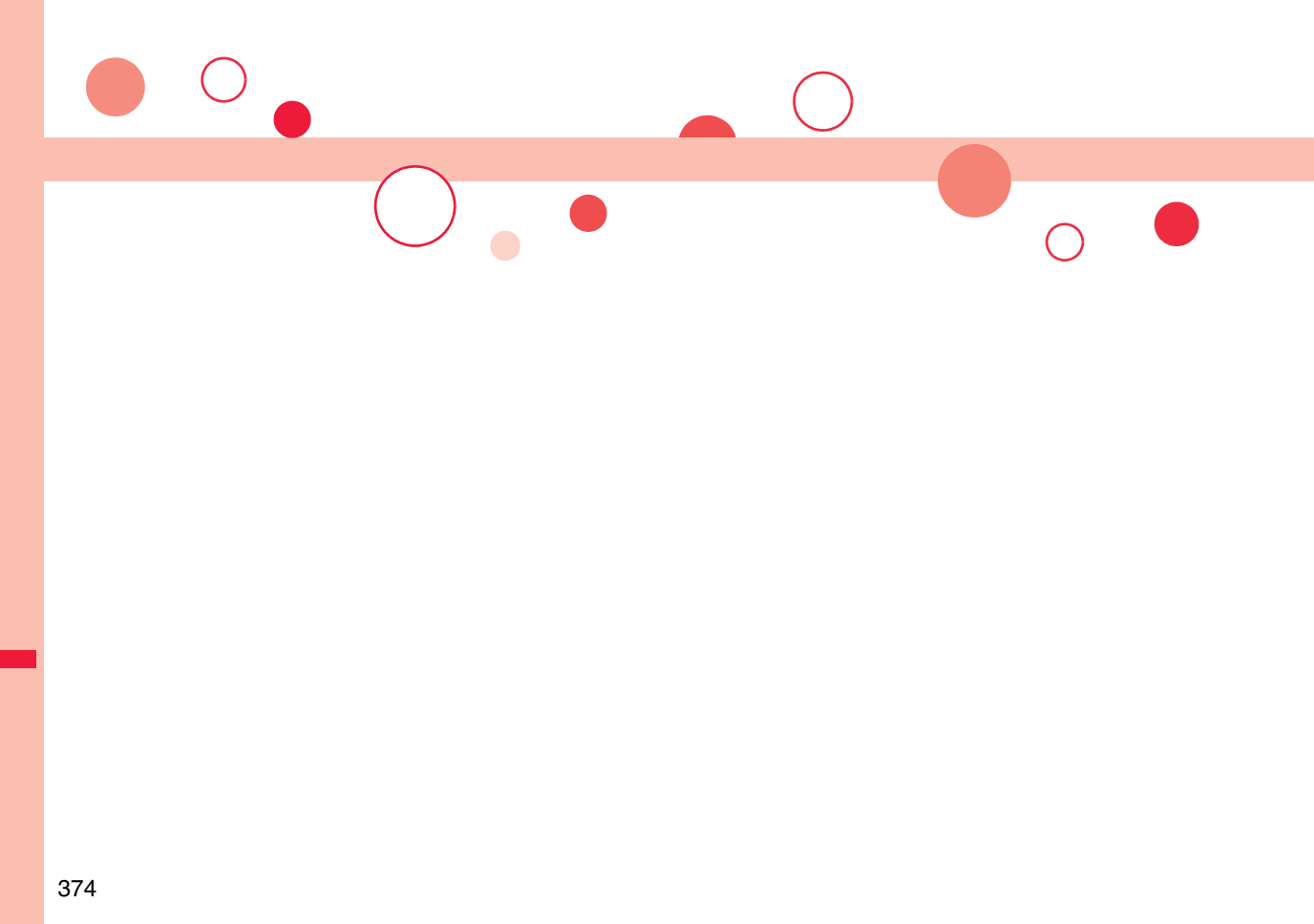

# Character Entry

Entering Characters . . . . .	<Character Entry>	376
Entering Characters in Mode 1 (5-touch) .....	<Mode 1 (5-touch)>	376
Using Common Phrases . . . . .	<Common Phrases>	381
Cutting/Copying/Pasting Characters . . . . .		381
Storing Words in Own Dictionary . . . . .	<Own Dictionary>	382
Using Learned Words . . . . .		382
Using Downloaded Dictionary . . . . .	<Download Dictionary>	383
Entering Characters in Mode 2 (2-touch) .....	<Mode 2 (2-touch)>	383
Entering Characters in Mode 3 (NIKO-touch) .....	<Mode 3 (NIKO-touch)>	384

For details on “Kuten Code List”, refer to the PDF version of “Kuten Code List” on the provided CD-ROM or DOCOMO web page.  
To see the PDF version of “Kuten Code List”, you need to have Adobe® Reader®. If it is not installed in your personal computer, install Adobe® Reader® from the provided CD-ROM to see it.  
For details such as how to use it, refer to “Adobe Reader Help”.

## Entering Characters

The FOMA phone is provided with many functions that require to enter characters such as creating the Phonebook or composing mail messages.

### Character Entry Display

On the Character Entry (Edit) display, the information of character input method, input mode, and the remaining number of characters and others are displayed.

#### 1 Character input method

- 2 : Mode 2 (2-touch)
- 3 : Mode 3 (NIKO-touch)
- Not displayed in Mode 1 (5-touch).

#### 2 Input mode

- abc : Alphabet input mode
- 123 : Numeral input mode
- 漢 : Kanji/Hiragana input mode
- か : Katakana input mode

#### 3 Full/Half-pitch

- 1/4 : Full-pitch input mode
- 1/2 : Half-pitch input mode

#### 4 Remaining/Maximum bytes that can be entered

- "Number of entered characters" might be displayed depending on the function.
- One half-pitch character is counted as one byte and one full-pitch character as two bytes.
- Half-pitch character "°" and "°" are counted as one character.

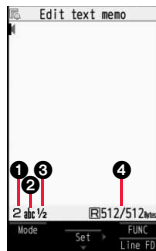

### Select Character Input Method

Three types of character input methods are available as shown below:

**Mode 1 (5-touch)** . . . . . See page 376

Multiple characters are assigned to a single key. Each time you press the key, characters switch.

**Mode 2 (2-touch)** . . . . . See page 383

Enter characters by pairs of numerals.

**Mode 3 (NIKO-touch)** . . . . . See page 384

Enter characters by pairs of numerals.

- 1 > Settings > Other settings > Character input method > Input mode > Put a check mark for modes to be used > (Finish)

- Select at least two modes.

- 2 Select a priority mode.

- Select a mode you use preferentially from modes selected in step 1.

### Switching modes on the Character Entry (Edit) display

Press and hold (Mode) for at least one second, or select "Char. input/dict." and then select "Change input mode" from the Function menu.

### <Mode 1 (5-touch)>

## Entering Characters in Mode 1 (5-touch)

In the step for entering characters, press (Mode) to switch input modes. You might not be able to switch to some modes depending on the function you enter.

### Enter Characters

You can enter characters by using Prediction Conversion which converts a few entered words into the predicted ones and by using Context Forecast which displays the next conversion candidates inferred from the relation between paragraphs.

- The FOMA phone increases prediction conversion candidates and context forecast candidates by learning characters.

<Example> Enter “タダの菓子” in a text memo.

## 1 ▶ Stationery ▶ Text memo ▶ Select <Not recorded>.

The Character Entry (Edit) display appears in prediction conversion mode when “Predict” is set to “ON”, and appears in ordinary conversion mode when set to “OFF”.

## 2 Enter hiragana characters in Kanji/Hiragana input mode.

た → Press once and once.

だ → Press once and once.

の → Press five times.

か → Press once.

し → Press twice.

- You can enter up to 24 characters at a time. However, when “Predict” is set to “ON”, if you enter 6 or more characters, the conversion mode is automatically switched to the ordinary conversion mode.
- When a character on the same key comes after a character, press to move the cursor, and enter the next character.  
If you set “Character set time”, you can omit the operation to move the cursor.
- To switch between uppercase and lowercase, press after you have entered characters.
- Each time you press (), characters are displayed in reverse order.
- If you set “Predict” to “ON”, each time you press , ordinary conversion mode and prediction conversion mode switch.
- You can press to display the candidate list of alphanumeric or katakana characters. Depending on the entered character, the conversion candidates for date/time are displayed.
- To fix a character as it is without conversion, press ().

## 3 Use to move the cursor onto “の”.

- The conversion mode is automatically switched to the ordinary conversion mode.

## 4 Use to move the cursor onto the candidate list

▶ Use to highlight “タダの” and press ().

- By pressing () or (), you can scroll the candidate list page by page.
- When you press while you are selecting a conversion candidate, the Character Entry (Edit) display returns.
- Press () to fix the whole paragraph.

## 5 Use to move the cursor onto the candidate list ▶ Use to highlight “菓子” and press ().

The selected characters are fixed.

- When the character strings that are assumed to be the context forecast candidates are found after fixing the characters, that context forecast candidates are displayed. Press to move the cursor onto the candidate list to enter the context forecast candidates.
- When you press while you are selecting the context forecast candidates, the Character Entry (Edit) display returns.

### Information

- The learning function stores up to 1,000 words, and the character of a high conversion rate goes up in the character order list.
- The candidate character strings are displayed from characters converted as usual and from a dictionary downloaded from sites.
  - Only a small number of character strings are registered by default so candidate characters might not be displayed in some cases. By doing the character conversion as usual, the converted characters are added to the candidate characters.
  - You can download a dictionary from sites and add candidate characters from the dictionary. However, when you delete the downloaded dictionary, the added candidate characters are also deleted from the existing candidate characters. (See page 162 and page 383)
- You can use Prediction Conversion and Context Forecast with 2-touch and NIKO-touch in Kanji/Hiragana input mode.
- The number of kanji characters that you can convert to is limited so you might not be able to convert to some kanji characters. You can use Kuten Code to enter kanji characters that you cannot convert to. The number of characters you can enter is 6355 in the JIS level-1 and level-2 kanji sets.
- Complicated kanji characters are partly deformed or simplified.

### Other Entry Functions

Item	Operation/Explanation
Katakana input	Press  () a few times to switch to Katakana input mode ▶ Press keys to enter characters.
Alphanumeric input	Press  () a few times to switch to Alphabet input mode ▶ Press keys to enter characters.
Numeral input	Press  () a few times to switch to Numeral input mode ▶ Press keys to enter numerals.

Item	Operation/Explanation
Line feed	Press  (Line Feed). <ul style="list-style-type: none"> <li>When the cursor is at the end of text and characters are fixed, you can press  to break a line.</li> </ul>
Smiley input	Enter “かお”▶ Use  to move the cursor onto the candidate list▶ Use  to select a smiley. <ul style="list-style-type: none"> <li>Smileys are stored in the pre-installed common phrases.</li> </ul>

## Information

### <Line feed>

- A line feed is counted as one full-pitch character.
- You cannot break a line depending on the function such as editing in the text box for i-mode.

## Correct Characters

### 1 Move the cursor to the left of the character you want to correct▶

The character at the right of the cursor is deleted.

Press and hold for at least one second to delete all characters on and after the cursor.

- When no character is found to the right side of the cursor, the character to the left side of the cursor is deleted. Press and hold for at least one second to delete all characters.

### 2 Enter a correct character.

The character is entered in the position of the cursor.

## Data you are editing

### When the battery alarm sounds

The data you have been editing is automatically fixed and saved. Charge the battery or replace it with a new charged battery to resume editing. However, you cannot save the unfixed data being converted.

### When you press

The confirmation display appears asking whether to discard the data you are editing.

### When a call or mail comes in

The Multitask function works, so the data you are editing is retained, and you can answer the call or receive the mail.

You can return to the data edit display by switching menu, by pressing and holding for at least one second. You can return to the data edit display also by ending the call or mail function.

## Predict

MENU 3 5

You can set whether to display the prediction conversion/context forecast candidates in the candidate list.

- MENU▶ Settings▶ Other settings  
▶ Character input method▶ Predict▶ ON or OFF

## Intelligent with Secret

MENU 3 5

You can set whether to store the characters converted in Secret Mode or Secret Data Only as learned words.

- MENU▶ Settings▶ Other settings  
▶ Character input method▶ Int.with secret  
▶ Enter your Terminal Security Code▶ ON or OFF

## Function Menu while Entering (Editing) Characters

- See page 176 for the Function menu of the Message Entry display.

Function menu	Operation/Explanation
Full pitch/Half pitch	You can switch between full pitch and half pitch.
Copy	See page 381.
Cut	See page 381.
Paste	See page 382.
Undo	You can undo the fixed, deleted, cut, or pasted text. You can undo the operation up to 10 times. However, you can undo the fixing of characters only once. <ul style="list-style-type: none"> <li>You can undo the operation also by pressing  Undo.</li> </ul>



Function menu	Operation/Explanation
<b>Pictograph/symbols (Pictograph)</b>	<p>You can enter pictographs while showing them on the display.</p> <p>▶ <b>Pictograph</b> ▶ <b>Highlight a pictograph and press</b>  (  ).</p> <p>Repeat the above step and enter other pictographs consecutively.</p> <ul style="list-style-type: none"> <li>You can display the Pictograph list also by pressing  in Kanji/Hiragana input mode.</li> <li>Press  to switch the pictograph lists in order of "Pictograph 1" → "Pictograph 2" → "Decomail-pictograph" [お気に入り (Favorite) through 文字 (Characters)]. However, you can enter "Decomail-pictograph" [お気に入り (Favorite) through 文字 (Characters)] only while editing the i-mode mail text. Press  to switch them in the reverse order.</li> <li>You can select a pictograph also by pressing a column number (number to the left) and then a row number (number at the top).</li> <li>Press  (  ) to display the Symbol list.</li> <li>Press  to switch between the list of all pictographs and ordinary input display.</li> </ul> <p>▶  (  )</p> <p>The selected pictograph is entered and the Character Entry (Edit) display returns.</p>
<b>Pictograph/symbols (Symbols)</b>	<p>You can enter symbols while showing them on the display.</p> <p>▶ <b>Symbols</b> ▶ <b>Highlight a symbol and press</b>  (  ).</p> <p>Repeat the above step and enter other symbols consecutively.</p> <ul style="list-style-type: none"> <li>You can display the Symbol list also by pressing and holding  for at least one second.</li> <li>Press  to switch the symbol lists in order of Half-pitch symbols → Full-pitch symbols. Press  to switch them in the reverse order.</li> <li>You can select a symbol also by pressing a column number (number to the left) and then a row number (number at the top).</li> <li>Press  (  ) to display the Pictograph list.</li> <li>Press  to switch between the list of all symbols and ordinary input display.</li> </ul> <p>▶  (  )</p> <p>The selected symbol is entered and the Character Entry (Edit) display returns.</p>

Function menu	Operation/Explanation
<b>Pictograph/symbols (Space)</b>	<p>You can enter a full-pitch space in full-pitch input mode, and a half-pitch space in half-pitch input mode.</p> <p>▶ <b>Space</b></p> <ul style="list-style-type: none"> <li>When the cursor is at the end of text, you can enter a space also by pressing .</li> </ul>
<b>Phrase/code/quote (Common phrases)</b>	<p>▶ <b>Common phrases</b> ▶ <b>Select a folder</b></p> <p>▶ <b>Select a common phrase.</b></p> <ul style="list-style-type: none"> <li>In the mode other than numeral input mode, you can bring up the folder list for common phrases also by pressing and holding  for at least one second.</li> </ul>
<b>Phrase/code/quote (Kuten code)</b>	<p>You can enter characters, numerals, and symbols on the Kuten Code list (see the PDF version of "Kuten Code List" on the provided CD-ROM).</p> <p>You can operate in Kanji/Hiragana input mode.</p> <p>▶ <b>Kuten code</b> ▶ <b>Enter a four-digit Kuten code.</b></p> <p>A character that matches the entered Kuten code is displayed, and the former input mode returns.</p> <ul style="list-style-type: none"> <li>When a character that matches the entered Kuten code is not found, a space is inserted.</li> </ul>
<b>Phrase/code/quote (Input time)</b>	<p>▶ <b>Input time</b> ▶ <b>Select a format for entering the date/time</b></p> <p>▶ <b>Enter the date/time.</b></p> <ul style="list-style-type: none"> <li>You can enter the date/time using the numeric keys.</li> <li>You can enter years 1800 through 2099.</li> </ul>
<b>Phrase/code/quote (Quote phonebook)</b>	<p>You can access and quote Phonebook entries. The following are the items you can quote:</p> <p>&lt;Inside FOMA phone&gt; Name, reading, phone number, mail address, postal address, birthday, memorandums</p> <p>&lt;Inside UIM&gt; Name, reading, phone number, mail address</p> <p>▶ <b>Quote phonebook</b> ▶ <b>Search the Phonebook</b></p> <p>▶ <b>Select a Phonebook entry</b></p> <p>▶ <b>Put a check mark for items to be quoted</b> ▶  (  )</p>
<b>Phrase/code/quote (Quote own data)</b>	<p>You can access and quote your personal information. The following are the items you can quote:</p> <p>Name, reading, phone number, mail address, postal address, birthday, memorandums</p> <p>▶ <b>Quote own data</b> ▶ <b>Enter your Terminal Security Code</b></p> <p>▶ <b>Put a check mark for items to be quoted</b> ▶  (  )</p>

Function menu	Operation/Explanation
<b>Phrase/code/quote (Bar code reader)</b>	You can start Bar Code Reader. (See page 143) ▶ <b>Bar code reader</b>
<b>Char. input/dict. (Own dictionary)</b>	See page 382.
<b>Char. input/dict. (Learned words)</b>	See page 382.
<b>Char. input/dict. (Change input mode)</b>	You can switch the character input methods. ▶ <b>Change input mode</b> ▶ <b>Select an input mode.</b> ● You cannot select the input mode that is not selected in "Input mode" of "Character input method" (see page 376).
<b>Char. input/dict. (Candid. disp. size)</b>	See "Character input (Candid. disp. size)" on page 111.
<b>Char. input/dict. (Predict)</b>	See page 378.
<b>Char. input/dict. (Candidate display)</b>	You can set whether to display context forecast candidates. ▶ <b>Candidate display</b> ▶ <b>ON or OFF</b>
<b>Char. input/dict. (Character set time)</b>	You can select whether to automatically fix the entered characters while you are entering characters in Mode 1 (5-touch). In addition, you can specify the time until characters are fixed. You can omit the operation of pressing  to move the cursor for the entry of characters on the same key. ▶ <b>Character set time</b> ▶ <b>Fast, Normal, Slow, or OFF</b>
<b>Char. input/dict. (2/NIKO-touch guide)</b>	You can select whether to list character conversion candidates at the lower part of the display when you press the first-digit key while you are entering characters in Mode 2 (2-touch) or Mode 3 (NIKO-touch). ▶ <b>2/NIKO-touch guide</b> ▶ <b>ON or OFF</b>
<b>Help</b>	You can check the operating procedures for entering characters. ▶ <b>Select an item.</b>

Function menu	Operation/Explanation
<b>JUMP</b>	You can move the cursor to the top or end of text. ▶ <b>To beginning or To end</b> ● When the Character Entry (Edit) display ranges over multiple pages, the cursor moves to the beginning or end of the page.

### Information

#### <Full pitch/Half pitch>

- When you switch to half-pitch mode in Kanji/Hiragana input mode of NIKO-touch, the input mode switches to half-pitch Katakana input mode.

#### <Pictograph/symbols (Pictograph)>

- You might not be able to enter pictographs depending on the Character Entry (Edit) display.
- Once you have entered pictographs, "History" appears first and then up to 27 records of pictographs entered from Pictograph 1 and Pictograph 2 and up to 36 records of Deco-mail pictograms are displayed. However, up to 18 records are displayed when the 1Seg viewer display is shown below the Message Composition display.
- You can enter up to 20 Deco-mail pictograms. When you insert other images, however, the number of Deco-mail pictograms that can be entered is reduced by the number of inserted images.

#### <Pictograph/symbols (Symbols)>

- You can enter "+" by pressing and holding  for at least one second in Numeral input mode.
- You might not be able to enter some symbols depending on the Character Entry (Edit) display.
- Once you have entered symbols, "History" appears first and then up to 27 records of half-pitch symbols and up to 36 records of full-pitch symbols are displayed. However, up to 18 records are displayed when the 1Seg viewer display is shown below the Message Composition display.

#### <Phrase/code/quote (Common phrases)>

- You might not be able to enter common phrases depending on the Character Entry (Edit) display.
- In Japanese Mode, the called-up contents of common phrases pre-installed in the FOMA phone differ depending on the input mode.

#### <Phrase/code/quote (Quote phonebook)>

- When you quote a postal address, you cannot quote "〒" or "-" of the postal code.

#### <Phrase/code/quote (Quote own data)>

- When you quote a postal address, you cannot quote "〒" or "-" of the postal code.
- The personal data of Number A is quoted in A Mode of 2in1, the personal data of Number B is quoted in B Mode, and the personal data of both Number A and Number B is quoted in Dual Mode.

## Information

<Char. input/dict. (Character set time)>

- You might not be able to enter characters as you like depending on this setting and your speed of operating keys.

<Common Phrases>

MENU 3 8

## Using Common Phrases

You can call up and enter, on the Character Entry (Edit) display, the common phrases pre-installed in the FOMA phone, or your own created common phrases.

The common phrases are sorted into five folders and each folder contains 10 of them. You can edit the pre-installed common phrases to save as your own common phrases.

## Display Common Phrases

- 1  Stationery ▶ Common phrase/dic.  
 Common phrases ▶ Select a folder.

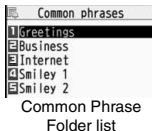

- 2 Select a common phrase.

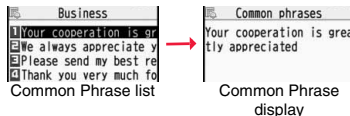



## Information

- Do not use half-pitch katakana characters and pictographs for your own common phrases used for composing mail. They might not be correctly displayed. (Pictographs can be used between i-mode mail messages.)
- The Japanese common phrases pre-installed in the “あいさつ (Greeting)” and “ビジネス (Business)” folders are called up in kanji/hiragana in Kanji/Hiragana input mode and called up in half-pitch katakana in other input modes.

## Function Menu of the Common Phrase Folder List

Function menu	Operation/Explanation
Edit folder name	▶ Enter a folder name. <ul style="list-style-type: none"><li>• You can enter up to 10 full-pitch/20 half-pitch characters.</li><li>• When you delete all the characters entered as a folder name, the folder name is reset to the default.</li></ul>
Reset name	You can reset the folder name to the default. ▶ YES

## Function Menu of the Common Phrase List/Common Phrase Display

Function menu	Operation/Explanation
Edit	▶ Enter a common phrase. <ul style="list-style-type: none"><li>• You can enter up to 64 full-pitch/128 half-pitch characters.</li><li>• When you delete all the characters in a common phrase, the common phrase is reset to the default.</li><li>• You can edit a common phrase by pressing  .</li></ul>
Reset this	You can reset the common phrase to the default. ▶ YES
Reset all	You can reset all the common phrases in the folder to the default. ▶ Enter your Terminal Security Code ▶ YES

## Cutting/Copying/Pasting Characters

### Cut/Copy

You can cut or copy up to 5,000 full-pitch/10,000 half-pitch characters.

- 1 Character Entry (Edit) display ▶  (FUNC)  
▶ Cut or Copy ▶ Select a start point.
  - You can press  (ALL) to select all characters.
- 2 Select an end point.

## Information

- If you copy/cut the Deco-mail text during composing and paste it, the information about the decoration is pasted as well.
- You might not be able to cut/copy the Deco-mail text, etc., because the memory space runs short depending on the data volume.

## Paste

You can paste cut or copied characters.

### 1 Character Entry (Edit) display

▶ Move the cursor to a start position for pasting

▶  (FUNC) ▶ Paste

<Own Dictionary>

MENU 3 8

## Storing Words in Own Dictionary

In Own Dictionary, you can store up to 100 frequently used words with your favorite reading.

### 1 Stationary ▶ Common phrase/dic.

▶ Own dictionary ▶ <New> ▶ Enter a word.

- Select a stored Own dictionary to check the stored contents.
- You can enter up to 10 full-pitch/20 half-pitch characters. However, you cannot enter line feeds.

### 2 Enter a reading.

- You can enter up to 10 hiragana characters. Also, you cannot store symbols other than "Long vowel (—)".
- Even if you enter a space, the word is stored with the space automatically deleted.

## Function Menu while Own Dictionary is Displayed

Function menu	Operation/Explanation
New	Go to step 1 of "Storing Words in Own Dictionary" on page 382.
Edit	Go to step 1 of "Storing Words in Own Dictionary" on page 382. • You can edit also by pressing  (Edit).

Function menu

Operation/Explanation

Delete this ▶ YES

Delete selected ▶ Put a check mark for own dictionaries to be deleted  
▶  (Finish) ▶ YES

Delete all ▶ Enter your Terminal Security Code ▶ YES

## Information

<Delete this> <Delete all>

- When you display Own Dictionary from the Function menu of the Character Entry (Edit) display, select "Delete" from the Function menu, then select "Delete this" or "Delete all".

<Delete selected>

- "Delete selected" does not appear when you display Own Dictionary from the Function menu of the Character Entry (Edit) display.

## Using Learned Words

The character strings once you entered are automatically stored and displayed as the conversion candidates of learned words.

## Checking Learned Words

### 1 Function menu while entering (editing) characters

▶ Char. input/dict. ▶ Learned words ▶ Select a column

▶ Select a record.

- To delete learned words, press  (FUNC) to select "Delete this" or "Delete all", and select "YES". If you select "Delete all", you need to enter your Terminal Security Code.

## Reset Learned Words

MENU 3 5

You can reset the learned words.

### 1 Settings ▶ Other settings ▶ Character input method

▶ Reset learned words

▶ Enter your Terminal Security Code ▶ YES

## Using Downloaded Dictionary

You can make dictionaries downloaded (see page 162) from sites valid.

### 1 [MENU] ▶ Stationery ▶ Common phrase/dic.

#### ▶ Download dictionary

#### ▶ Select a downloaded dictionary.

The downloaded dictionary you have selected is validated and indicated by "★".

- To invalidate a downloaded dictionary, perform the same operation.

- You can delete the pre-installed dictionaries. You can re-download them from the "P-SQUARE" site (see page 164). When you use a UIM other than the one used for downloading, the UIM security function (see page 37) is set for them.

### Function Menu while Downloaded Dictionary is Displayed

Function menu	Operation/Explanation
<b>Edit title</b>	▶ <b>Edit the title.</b> • You can enter up to 10 full-pitch/20 half-pitch characters.
<b>Set dictionary</b>	You can set the dictionary valid/invalid. Each time you operate, valid and invalid switch.
<b>Dictionary info</b>	You can display the dictionary title and version.
<b>Delete this</b>	▶ YES
<b>Delete all</b>	▶ Enter your Terminal Security Code ▶ YES

### Information

#### <Edit title>

- If you delete all the characters entered as a title, the title is reset to the default.

## Entering Characters in Mode 2 (2-touch)

When you press two numeric keys to enter two-digit numerals, a character (symbol) that corresponds to the numerals is entered. Press the first key to list candidate characters (symbols) at the lower part of the display. To list candidate characters, you need to set "2/NIKO-touch guide" to "ON" in advance.

- See page 440 for how characters are assigned to the numeric keys (2-touch).
- See page 376 for switching to "2-touch".

### Switch Input Modes (2-touch)

Press [Mode] from the Character Entry (Edit) display to switch input modes. You might not be able to switch to some modes depending on the function you enter.

### Enter Characters

<Example> Enter "タダの菓子" in a text memo.

### 1 [MENU] ▶ Stationery ▶ Text memo ▶ Select <Not recorded>.

The Character Entry (Edit) display appears.

### 2 Enter hiragana characters in Kanji/Hiragana input mode.

た → 4 1  
 だ → 4 1, (X)  
 の → 5 5  
 か → 2 1  
 し → 3 2

- To enter " " or " ", enter the character and then press (X).

- Press (8) (0) to switch between uppercase and lowercase. You can switch uppercase and lowercase also by entering the character that can be switched between uppercase and lowercase and pressing (↔).

After entering hiragana characters, go to step 3 on page 377.

<Mode 3 (NIKO-touch)>

## Entering Characters in Mode 3 (NIKO-touch)

When you press two numeric keys to enter two-digit numerals, a character (symbol) that corresponds to the numerals is entered. Press the first key to list candidate characters (symbols) at the lower part of the display. To list candidate characters, you need to set "2/NIKO-touch guide" to "ON" in advance.

- See page 441 for how characters are assigned to the numeric keys (NIKO-touch).
- See page 376 for switching to "NIKO-touch".

## Switch Input Modes (NIKO-touch)

Press  (Mode) from the Character Entry (Edit) display to switch input modes. You might not be able to switch to some modes depending on the function you enter.











## Enter Characters



<Example> Enter "タダの菓子" in a text memo.

**1**  **Stationery** ▶ **Text memo** ▶ **Select** <Not recorded>.

The Character Entry (Edit) display appears.

**2** Enter hiragana characters in Kanji/Hiragana input mode.

た →    
だ →   ,   
の →    
か →    
し →  

- To enter " " or " ", enter the character and then press .
- Enter the character that can be switched between uppercase and lowercase and press ; then you can switch.

After entering hiragana characters, go to step 3 on page 377.

# Network Services

Checking New Voice Mail Messages ..... <Check New Messages>	386	Switching Guidance Language between Japanese and English ..... <English Guidance>	393
Using Voice Mail Service ..... <Voice Mail>	386	Using Service Numbers ..... <Service Numbers>	393
Using Call Waiting Service ..... <Call Waiting>	388	Selecting Response to Incoming Calls during a Call ..... <Arrival Call Act>	394
Using Call Forwarding Service ..... <Call Forwarding>	390	Setting Remote Control ..... <Remote Control>	395
Using Nuisance Call Blocking Service ..... <Nuisance Call Blocking>	391	Setting Additional Number ..... <Multi Number>	395
Using Caller ID Display Request Service ..... <Caller ID Request>	392	Using 2in1 ..... <2in1>	396
Using Dual Network Service ..... <Dual Network>	392	Using OFFICEED ..... <OFFICEED>	402
		Using Additional Services ..... <Additional Service>	402

## ■ Available Network Services

The following are the DOCOMO network services available from the FOMA phone.

For the outline and usage method of each service, see the reference page in the table below.

- The network services are not available when you are out of the service area or out of reach of radio waves.
- For details, refer to "Mobile Phone User's Guide [Network Services]".
- For subscriptions and inquiries, contact "DOCOMO Information Center" on the back page of this manual.

Service	Application	Monthly fee	Reference
Voice Mail Service	Required	Charged	386
Call Waiting Service	Required	Charged	388
Call Forwarding Service	Required	Free	390
Nuisance Call Blocking Service	Not required	Free	391
Caller ID Notification Service	Not required	Free	45
Caller ID Display Request Service	Not required	Free	392
Dual Network Service	Required	Charged	392

Service	Application	Monthly fee	Reference
English Guidance	Not required	Free	393
Multi Number	Required	Charged	395
2in1	Required	Charged	396
Public Mode (Drive Mode)	Not required	Free	66
Public Mode (Power Off)	Not required	Free	67
OFFICEED	Required	Charged	402
Melody Call	Required	Charged	94

- "OFFICEED" is a pay service which is available on a subscription basis. For details, visit the DOCOMO-enterprise-oriented web site (<http://www.docomo.biz/d/212/>). (Japanese only)
- "Deactivate" does not mean that the contract for Voice Mail Service, Call Forwarding Service or other services is canceled.
- You can store new network services in the menu when they are provided by DOCOMO. (See page 402)
- In this manual, a brief outline for each network service is described following the procedure using the menus of the FOMA phone.







<Check New Messages>

## Checking New Voice Mail Messages

You can check whether any message is held at the Voice Mail Service Center.

1  ► Service ► Voice mail ► Check new messages ► OK

### About checked results

- If any voice mail message is held, the "Voice mail" icon (  ) and another Voice Mail icon such as "  " appear to inform you of the held message.
- To erase the Voice Mail icon such as "  ", dial at the Voice Mail Service Center for saving or erasing the voice mail message or follow the operations of "Erase icon".
- The Voice Mail icons switch among , , , etc., and  (6 or more messages) according to the number of the messages held at the Voice Mail Service Center. The displayed number is the number of messages informed by the guidance when you play back new messages. Saved messages are not included.
- If you set "Message notification", the ring tone sounds each time a message is added.
- See page 387 for how to play back voice mail messages.

### When " " appears

You cannot check voice mail messages. Move to a place where "  " is cleared.

<Voice Mail>

## Using Voice Mail Service

This service provides an answer message for incoming voice calls/ videophone calls and then holds voice mail messages on behalf of you when you are in a place where radio waves do not reach, the power is turned off, or you cannot answer calls.

- When Record Message (see page 68) is simultaneously activated and you want to give Voice Mail Service priority, set its ring time shorter than that for Record Message.
- When you do not answer an incoming voice call or videophone call while Voice Mail Service is set to "Activate", the call is recorded as a missed call in "Received calls", and the "Missed call" desktop icon appears on the Stand-by display.
- Voice Mail Service is valid for voice calls and videophone calls.
- A voice mail message can be recorded for up to three minutes. Twenty messages can be recorded respectively for voice calls and videophone calls and held at the Center for up to 72 hours.
- When a voice mail message of a videophone call is retained at the Voice Mail Service Center, you are notified by an SMS message.
- Make a voice call at "1412" to change the Voice Mail setting for videophone calls.
- When a Chara-den call is connected to the Voice Mail Service Center, DTMF operation is not available. Switch to "Send DTMF tone" from the Function menu. (See page 73)
- When a call comes in while Voice Mail Service is set to "Activate", the ring tone (specified by "Select ring tone") will sound. (You can change the ring time for incoming calls. See page 387) If you answer the call within the specified time, you can start talking. If you do not answer, the call is connected to the Voice Mail Service Center.
- You can just press keys to connect an incoming call to the Voice Mail Service Center. Also, you can connect the call that comes in during a call to the Center.

### Basic Flow of Voice Mail Service

**Step 1: Set the service to "Activate".**

**Step 2: The caller records a voice/video message.\***

**Step 3: Play back the message.**

\* If the caller wants to skip playback of the answer message and record a message such as when in a hurry, he/she can immediately switch to the recording mode by pressing "#" while the answer message is played back.



## Use Voice Mail Service







**1**  **Service** **>** **Voice mail** **>** **Do the following operations.**

Item	Operation/Explanation
<b>Play messages</b>	You can play back messages recorded as the Voice Mail. ▶ <b>YES</b> ▶ <b>Operate following the voice guidance.</b>
<b>Activate</b>	▶ <b>YES</b> ▶ <b>YES</b> ▶ <b>Enter a ring time (seconds).</b> ● Enter from "000" through "120" in three digits.
<b>Deactivate</b>	▶ <b>YES</b>
<b>Set ring time</b>	You can set the ring time until the call is connected to the Voice Mail Service Center. ▶ <b>Enter a ring time (seconds).</b> ● Enter from "000" through "120" in three digits.
<b>Check setting</b>	You can check the setting contents of Voice Mail Service.
<b>Setting</b>	You can switch the setting contents of Voice Mail Service. ▶ <b>YES</b> ▶ <b>Operate following the voice guidance.</b>
<b>Check new messages</b>	See page 386.
<b>Message notification</b>	You can set the ring tone to sound when a new message is recorded. The ring tone set for "Mail" of "Select ring tone" sounds for about five seconds. ▶ <b>YES</b> or <b>NO</b>
<b>Erase icon</b>	You can erase the Voice Mail icons (such as  ) from the Stand-by display. ▶ <b>YES</b>

Item	Operation/Explanation
<b>Activate notice call</b>	By an SMS message, you are informed of the received calls which came in when you were out of reach of radio waves or the power was turned off. ▶ <b>Select an item.</b> <b>All calls</b> . . . . . Informs you of all received calls. <b>Calls w/ caller ID</b> . . . . . Informs you of only the calls that notified the phone number.  ▶ <b>YES</b>
<b>Deactivate notice call</b>	▶ <b>YES</b>
<b>Notice call status</b>	You can check the setting contents of notice call.

### Information

<Play messages> <Setting>

- You cannot operate during a call.
- If you press  through , , or  following the voice guidance, you may not be able to end the call by pressing . In this case, press  again.

<Set ring time>

- If "Set ring time" is set to 0 seconds, the calls are not recorded in Received Calls.

<Erase icon>

- Even if you erase the Voice Mail icons, the messages held at the Voice Mail Service Center are not erased.



<Activate notice call>

- Even when you set to reject all SMS messages, you are informed by SMS message of the received call records.

## Forward an Incoming Call to Voice Mail Service Center during Ringing

You can connect an incoming call to the Voice Mail Service Center just by a simple key operation. Even if you do not set Voice Mail Service to "Activate", the service will be available using this function.

**1** During ringing   **>** **Voice mail**

- You can connect the incoming call to the Voice Mail Service Center also by pressing  , and pressing .

## Forward Specified Calls to Voice Mail Center

You can automatically connect the calls coming from the phone numbers stored in the Phonebook to the Voice Mail Service Center regardless of the Activate/Deactivate setting for the Service.

You can specify up to 20 phone numbers.

This setting is valid only when the caller notifies his/her phone number. It is advisable to activate "Caller ID request" at the same time.

### 1 Detailed Phonebook display ( FUNC ) Restrictions ▶ Enter your Terminal Security Code ▶ Voice mail

"Voice mail" is indicated by "★".

- To release "Voice mail", perform the same operation.

#### Information

- When a call comes in from the phone number set with this function, the ring tone sounds for about one second and then the call is connected to the Voice Mail Service Center. You will be notified of the call by the icons on the desktop (see page 68 and page 107) and "Received calls".
- Even if you set this function, all incoming calls are not connected to the Voice Mail Service Center when you set "Personal data lock" while Voice Mail Service is deactivated.

## <Call Waiting>

### Using Call Waiting Service

When a call comes in during a call, this service notifies you of it by the ring tone in call, and enables you to place the current call on hold to answer the new call.

Further, you can make a call to another person putting the current call on hold.

- To use Call Waiting Service, set "Arrival call act" (see page 394) to "Answer" in advance. When another option is set, you cannot answer a voice call during a voice call even if you set "Call waiting" to "Activate".

### Use Call Waiting Service

#### 1 Service ▶ Call waiting ▶ Do the following operations.

Item	Operation/Explanation
Activate	▶ YES
Deactivate	▶ YES
Check setting	You can check the setting contents of Call Waiting Service.



### Answer an Incoming Call during a Call

#### 1 Another call comes in during a call

The current call is automatically put on hold so that you can receive another call.

- "Multi calling" is displayed when there is the party on hold.
- Each time you press , you can switch the parties you can talk with.

## Information

- For an incoming call or communication that is not supported by Call Waiting, press  from the Call Receiving display to show the confirmation display telling that you can answer a new call if you end the current call. Press  to end the current call, and then the Call Receiving display appears. When you select "OK", the Call Receiving display during a call returns.
- If a call comes in during a videophone call, the FOMA phone operates as follows:
  - The moving image, i-motion movie or Flash movie set as the image for incoming calls is not displayed.
  - A "Pre-installed" substitute image is sent to the other party of the current call.
  - The vibrator does not work.
- When a voice call comes in while dialing 117, you hear an in-call ring tone but cannot answer that call. The call is recorded as a missed call in Received Calls.

## End a Call to Answer Another Call

- 1** Another call comes in during a call ▶ 
- The ring tone sounds. You can answer the new call.

## Continue the Current Call



- 1** Another call comes in during a call ▶  (FUNC)
- ▶ Do the following operations.

Function menu	Operation/Explanation
Call rejection	You can reject a new incoming call and resume the current call.
Call forwarding	You can forward a new incoming call to the forwarding destination and resume the current call.
Voice mail	You can connect a new incoming call to the Voice Mail Center and resume the current call.

## Information





- Incoming calls are rejected during a videophone call or answer-hold (On Hold), or while Record Message is working. The "Missed call" icon appears when the current call ends, and the call is recorded in Received Calls. (The "Missed call" icon might not appear and the received call record might not be recorded depending on the contracts and setting for Voice Mail, Call Waiting, and Call Forwarding Services.)

## Hold a Call to Make a New Call

- 1** Enter another party's phone number during a call ▶ 
- You can talk with the party you have dialed.  
The call with the first party is automatically put on hold.
- "Multi calling" is displayed when there is the party on hold.
  - Each time you press , you can switch the parties you can talk with.

## End a Call to Answer the Held Call

You can answer the held call after finishing the current call.

- 1** During Multi calling ▶ 
- The ring tone sounds.
- 2** Press  or  (Answer).
- When the other party you have been talking with ends the call, press  to talk with the party on hold.

## End a Held Call

- 1** During Multi calling ▶  (FUNC) ▶ End held call

## Information

- When another call comes in while the current call is put on hold, the held call is released.
- When another call comes in during Multi-calling, the Call Receiving display appears. Press  (FUNC) and select "End held call" to end the held call. If you select "End talk", you can end the current call.

## <Call Forwarding>

# Using Call Forwarding Service

This service forwards incoming voice calls/videophone calls when you are in a place where radio waves do not reach, the power is turned off, or you do not answer calls within a specified time.

- When Record Message (see page 68) is simultaneously activated and you want to give Call Forwarding Service priority, set its ring time shorter than that for "Record message setting".
- When you do not answer an incoming voice call or videophone call while Call Forwarding Service is set to "Activate", the call is stored as a missed call in "Received calls", and the "Missed call" desktop icon appears on the Stand-by display.
- When a call comes in while Call Forwarding Service is set to "Activate", the ring tone (specified by "Select ring tone") will sound. (You can change the ring time for incoming calls. See page 390) If you answer the call within the specified time, you can start talking.
- You can just press keys to forward incoming calls. Also, you can forward the call that comes in during a call.

## Basic Flow of Call Forwarding Service

**Step 1: Store the phone number of forwarding destination.**

**Step 2: Set Call Forwarding Service to "Activate".**

**Step 3: A call comes into your FOMA phone.**

**Step 4: The call is automatically forwarded to the specified destination if you do not answer.**

## Use Call Forwarding Service

- 1**  **Service** ▶ **Call forwarding**  
▶ **Do the following operations.**

Item	Operation/Explanation
Activate	<p>▶ <b>Register fwd number</b> ▶ Enter the phone number of forwarding destination.</p> <ul style="list-style-type: none"><li>• Press  to select the phone number from the Search Phonebook display. (See page 83)</li></ul> <p>▶ <b>Set ring time</b> ▶ Enter a ring time (seconds).</p> <ul style="list-style-type: none"><li>• Enter from "000" through "120" in three digits.</li></ul> <p>▶ <b>Activate</b> ▶ YES</p>

Item	Operation/Explanation
Deactivate	▶ YES
Change forwarding No.	<p>▶ Enter the phone number of forwarding destination</p> <p>▶ Select an item.</p> <p><b>Change No.</b></p> <p>... Select this when Call Forwarding Service is activated.</p> <p><b>Change No. +Activate</b></p> <p>... Select this while Call Forwarding Service is deactivated and you want to activate the Service as soon as the forwarding destination is changed.</p> <ul style="list-style-type: none"><li>• Press  to select the phone number from the Search Phonebook display. (See page 83)</li></ul>
Setting if fwd. No. busy	<p>You can set an incoming call to be connected to the Voice Mail Service Center when the forwarding destination is busy.</p> <p>▶ YES</p>
Check setting	<p>You can check the phone number and ring time of forwarding destination.</p>

## Information

- If you are out of reach of radio waves or the power is turned off, the ring tone does not sound and the call is automatically forwarded. The call fee from the forwarder to the forwarding destination is charged for the forwarder who has subscribed for the service.
- If the ring time for Call Forwarding Service is set to 0 seconds, the calls are not recorded in Received Calls.

## Set On/Off of Forwarding Guidance

- 1**     ▶   
▶ Operate following the voice guidance.

- For details, refer to "Mobile Phone User's Guide [Network Services]".

## Forward an Incoming Call during Ringing

You can forward an incoming call to the phone number you specified as a "Forwarding number" by a simple key operation. Even if you do not set Call Forwarding Service to "Activate", the service will be available using this function.

1 During ringing   Call forwarding

## Forward Specified Calls to Specified Destination

You can automatically forward the calls from the specified phone numbers stored in the Phonebook after the ring tone sounds for about one second, regardless of the Activate/Deactivate setting for Call Forwarding Service.

You can specify up to 20 phone numbers.

This setting is valid only when the caller notifies his/her phone number. It is advisable to activate "Caller ID request" at the same time.

1 Detailed Phonebook display   Restrictions  
▶ Enter your Terminal Security Code ▶ Call forwarding

"Call forwarding" is indicated by "★".

- To release "Call forwarding", perform the same operation.

### Information

- Even if you set this function, all incoming calls are not forwarded when you set "Personal data lock" while Call Forwarding Service is deactivated.
- If you have not signed up for Call Forwarding Service or have not set the forwarding destination, the call will be a missed call.

## <Nuisance Call Blocking>

### Using Nuisance Call Blocking Service

You can register so as not to receive "nuisance calls" such as crank calls.

Once you register a phone number for rejection, calls from that phone number is automatically rejected and the guidance answers the caller.



- When a call comes in from the phone number stored for rejection, the ring tone does not sound. The call is not recorded in Received Calls, either.

■ Relation between each Service and incoming calls while Nuisance Call Blocking Service is activated

Service	Handling of incoming calls from the caller rejected as Register Caller
Voice Mail Service	Call Rejection guidance is played back. (Message is not held.)
Call Forwarding Service	Call Rejection guidance is played back. (Not forwarded to forwarding destination.)
Call Waiting Service	Call Rejection guidance is played back.
Caller ID Display Request Service	Call Rejection guidance is played back.
Public Mode (Drive Mode)	Call Rejection guidance is played back. [Public Mode (Drive Mode) guidance is not played back.]

For details, refer to "Mobile Phone User's Guide [Network Services]".

1  Service ▶ Nuis. call blocking  
▶ Do the following operations.

Item	Operation/Explanation
<b>Register caller</b>	You can register the phone number of the call that arrived last for rejection. ▶ YES ▶ OK
<b>Register selected No.</b>	You can register the specified phone number for rejection so that the call from that phone number does not come in. ▶ Enter a phone number ▶ YES • Press  to select the phone number from the Search Phonebook display, and press  to select from the Dialed Call list, and press  to select from the Received Call list.

Item	Operation/Explanation
Delete last entry	You can delete the phone number registered last. Repeat the same procedures to delete phone numbers one by one from the one registered last. ▶ YES ▶ OK
Delete all entries	▶ YES ▶ OK
Check No. of entries	You can check the number of phone numbers registered for rejection.

&lt;Caller ID Request&gt;

## Using Caller ID Display Request Service

This service provides the guidance asking the caller ID notification against incoming voice calls/videophone calls without caller IDs, and then automatically disconnects the call.

- The call rejected by Caller ID Display Request Service is not stored in "Received calls", and the "Missed call" desktop icon does not appear.

■ Relation between each Service and incoming calls while Caller ID Display Request Service is activated

Service	Handling incoming call from the caller who does not notify a caller ID
Voice Mail Service	Caller ID Request guidance is played back. (Message is not held.)
Call Forwarding Service	Caller ID Request guidance is played back. (Not forwarded to the forwarding destination.)
Call Waiting Service	Caller ID Request guidance is played back.
Nuisance Call Blocking Service	For the call from the number registered to be rejected, the Call Rejection guidance is played back.
Public Mode (Drive Mode)	Caller ID Request guidance is played back. [Public Mode (Drive Mode) guidance is not played back.]

1  ▶ Service ▶ Caller ID request  
▶ Do the following operations.

Item	Operation/Explanation
Activate	▶ YES ▶ OK

Item	Operation/Explanation
Deactivate	▶ YES ▶ OK
Check setting	You can check the setting contents of Caller ID Display Request Service.

### Information

- If you activate this service while you set "Call setting w/o ID" to "Reject", this service has priority.
- You can set and confirm this setting from the FOMA phone with your own UIM inserted. You cannot remote-control the setting from landline phones, public phones, and other mobile phones.

&lt;Dual Network&gt;

## Using Dual Network Service

You can use a mova phone with the phone number for your FOMA phone. You can use either your FOMA phone or mova phone depending on the service area.

- You cannot use your FOMA phone and mova phone at the same time.
- You need to operate Dual Network Switching from the phone which is not using the service.

1  ▶ Service ▶ Dual network  
▶ Do the following operations.

Item	Operation/Explanation
Dual network switching	You can switch to the FOMA phone so that you can use it. Operate when the FOMA is in the FOMA service area. ▶ YES ▶ Enter your Network Security Code. • See page 114 for the Network Security Code.
Check setting	You can check the setting contents of Dual Network Service.

## Dual Network Service by Key Operations

You can press a few keys to use Dual Network Service instead of using the menu function in the FOMA phone.

### ■ To switch the phones (from the phone which is not using the service)

1 5 4 0 → Enter your Network Security Code

→ Guidance for switching →

### ■ Check network status (from the phone you want to check)

1 5 4 6 → Check →

### Information

- For details, refer to "Mobile Phone User's Guide [Network Services]".
- If you press (0) through (9), (\*), or (#) following the voice guidance, you may not be able to end the call by pressing (end call). In this case, press (end call) again.

## <English Guidance>

# Switching Guidance Language between Japanese and English

You can set the guidance for network services such as "Voice mail" or the voice guidance such as for the out-of-service area, to be played back in English.

### ■ Outgoing (Guidance to yourself)

Language	Description
Japanese	Plays back the guidance in Japanese.
English	Plays back the guidance in English.

### ■ Incoming (Guidance to the caller)

Language	Description
Japanese	Plays back the guidance in Japanese.
Japanese+English	Plays back the guidance first in Japanese and then in English.
English+Japanese	Plays back the guidance first in English and then in Japanese.

## 1 MENU ▶ Service ▶ English guidance

▶ Do the following operations.

Item	Operation/Explanation
Guidance setting	▶ Select an item.
	<b>Outgoing+Incoming</b> . . . Sets the guidance for outgoing and incoming calls at a time.
	<b>Outgoing call</b> . . . . . Sets the guidance for outgoing calls. <b>Incoming call</b> . . . . . Sets the guidance for incoming calls.
	▶ Select a guidance language to be set ▶ YES
	• If you select "Outgoing+Incoming", set the guidance for outgoing calls, and then set the guidance for incoming calls.
Check setting	You can check the setting contents of the English guidance.

### Information

- You can set and confirm this setting from the FOMA phone with your own UIM inserted. You cannot remote-control the setting from landline phones, public phones, and other mobile phones.

## <Service Numbers>





# Using Service Numbers

You can make calls to the DOCOMO Information Center or DOCOMO repair counter.

- Depending on the UIM you use, the displayed items might differ or no items are displayed.

## 1 MENU ▶ Service ▶ Service numbers

▶ Do the following operations.

Item	Operation/Explanation
ドコモ故障問合せ (DOCOMO repair counter)	You can make a call to the repair counter. ▶  
ドコモ総合案内・受付 (DOCOMO Information Center)	You can make a call to the Information Center. ▶  

## &lt;Arrival Call Act&gt;

## Selecting Response to Incoming Calls during a Call

You can set how to manage a voice call/videophone call or 64K data communication that comes in during a call when you have signed up for "Voice mail", "Call forwarding" or "Call waiting".

- When you have not signed up for "Voice mail", "Call forwarding", or "Call waiting", you cannot answer calls that come in during a call.
- To use "Arrival call act", you need to set "Set in-call arrival act" to "Activate".

**1**  **Service ▶ Arrival call act**  
▶ Do the following operations.

Item	Operation/Explanation
Voice mail	You can connect voice calls or videophone calls that come in during a call to the Voice Mail Service Center, regardless of the setting for "Call waiting" or "Voice mail".
Call forwarding	You can forward voice calls or videophone calls that come in during a call to the forwarding destination, regardless of the setting for "Call waiting" or "Call forwarding".
Call rejection	You can reject voice calls, videophone calls, or 64K data communication that come in during a call.

Item	Operation/Explanation
Answer	<p>If you have set "Call waiting" to "Activate" and receive a voice call during a voice call, you can use "Call waiting". Any of the following operations is available during a voice call (when "Call waiting" is set to "Deactivate"), during a videophone call, or during 64K data communication.</p> <ul style="list-style-type: none"> <li>• You can answer incoming voice calls, videophone calls, or 64K data communication after finishing the current voice call, videophone call or 64K data communication.</li> <li>• From the Function menu, you can manually operate voice calls, videophone calls, or 64K data communication that come in during a call.</li> <li>• When "Voice mail" or "Call forwarding" is set to "Activate", your FOMA phone follows that setting.</li> </ul>

### Set In-call Arrival Act

You can activate/deactivate the functions you selected in Arrival Call Act and can check the setting contents.

**1**  **Service ▶ Set in-call arrival act**  
▶ Do the following operations.

Item	Operation/Explanation
Activate	▶ YES
Deactivate	▶ YES
Check setting	You can check the setting contents of In-call Arrival Act.

#### Information

- You can set and confirm this setting from the FOMA phone with your own UIM inserted. You cannot remote-control the setting from landline phones, public phones, and other mobile phones.



## <Remote Control>

# Setting Remote Control

You can set "Voice mail" or "Call forwarding" to be operated from touch-tone landline phones, public phones, DOCOMO mobile phones, or others.

- To use "Voice mail" or "Call forwarding" overseas, you need to set "Remote control" to "Activate" in advance.

## 1 Service ▶ Remote control ▶ Do the following operations.

Item	Operation/Explanation
Activate	▶ YES
Deactivate	▶ YES
Check setting	You can check the setting contents of Remote Control.

### Information

- You can set and confirm this setting from the FOMA phone with your own UIM inserted. You cannot remote-control the setting from landline phones, public phones, and other mobile phones.

## <Multi Number>

# Setting Additional Number





You can add and use the additional number 1 and 2 at maximum as the phone numbers of your FOMA phone besides the basic number.

- When you remove or replace the UIM, the multi number settings (name, phone number, etc.) stored in the FOMA phone might be erased. In this case, store them again.
- The name that corresponds to each multi number (Basic Number/Additional Number1/Additional Number2) appears on the dialing display/Call Receiving display.
- When you try to make a call from Redial, Dialed Calls, or Received Calls, the multi number you dialed/received at that time appears and the call is made by this number.

## Number Setting

You can edit the registration name for the basic number, register additional numbers, and edit the registration names for them.

## 1 Service ▶ Multi number ▶ Number setting ▶ Select a phone number.

- You can register/edit also by pressing  (FUNC) and selecting "Edit" or by pressing  (Edit).
- Select the basic number or registered additional number to check the registration name and phone number.
- To reset the registration name of the basic number, press  (FUNC) and select "Reset BasicNo. name", then select "YES".
- To delete the registered additional number, press  (FUNC) and select "Delete this" or "Delete all", then select "YES".

## 2 Enter a registration name ▶ Enter a phone number.

- You can enter up to 8 full-pitch/16 half-pitch characters for a registration name.
- You cannot edit the phone number of the basic number.

## Set Multi Number

By switching this setting, you can make all calls from a specified phone number.

## 1 Service ▶ Multi number ▶ Set multi number ▶ Select a phone number.

**Basic Number.** . . . . . Dials by the contracted phone number.

**Additional Number1/2** . . . . . Dials by an additional number.

- When the registration name is changed, each registration name is displayed. However, the registration name is not displayed during Personal Data Lock.

## 2 YES

## Set Own Phone Number when Making a Call

Before making a call, you can select a phone number to be notified to the other party from the Function menu, and then make a call.

### 1 Enter a phone number

OR

bring up the detailed display of a Phonebook entry, redial item, dialed call record, or received call record.

### 2 ► Multi number ► Select a phone number.

• To cancel the additional number, select "Cancel prefix".

## Information

- If you select "Basic Number" or "Additional Number1/2", "X590#", "X591#", or "X592#" is added after the phone numbers.

## Check Setting

You can check a phone number set for "Set multi number".

### 1 ► Service ► Multi number ► Check setting

## Set as Ring Tone

You can set a ring tone for calls that come in to the additional number.

### 1 ► Service ► Multi number ► Set as ring tone ► Select an additional number.

Go to step 2 on page 92.

When the ring tone is set to "Same as ring tone", the ring tone will be the one set for "Phone" or "Videophone" of "Select ring tone".

<2in1>

## Using 2in1

You can use two phone numbers/mail addresses on your single FOMA phone. By using respective modes, you can operate your FOMA phone as if you are using two sets of them.

The following three modes are available with 2in1:

### A Mode

You can use your phone number (Number A) to make calls and your i-mode mail address (Address A) to send/receive mail messages, and can browse their related data.

### B Mode

You can use your 2in1 phone number (Number B) to make calls and access the sites for Web mail (Address B), and can browse their related data.

### Dual Mode

This mode has the functions of both A Mode and B Mode.

- For details on 2in1, refer to "Mobile Phone User's Guide [2in1]".
- Address B is used to send/receive mail messages via the dedicated Web mail site.
- You can use packet communication even in B Mode if you subscribe to i-mode.
- You can subscribe to either 2in1 or Multi Number.
- When you replace a UIM with another one (2in1 contractor → 2in1 contractor) while using 2in1, perform "2in1 function OFF" (see page 397) and then set "2in1 setting" to "YES", or perform "Auto acquire No. B" (see page 366), to acquire the correct Number B.
- When you replace a UIM with another one (2in1 contractor → 2in1 non-contractor), perform "2in1 function OFF" as well to update the owner's information to the correct one.
- See page 399 for how this service works for each mode.

## Activate 2in1

### 1 ► Service ► 2in1 setting ► Enter your Terminal Security Code ► YES

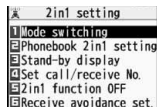

When you activate 2in1, the 2in1 Setting Menu display appears.

- This display appears also by pressing and holding  2in1 Setting Menu display for at least one second from the Stand-by display and entering your Terminal Security Code.



## Configure 2in1 Setting

### 1 2in1 Setting Menu display ▶ Do the following operations.

Item	Operation/Explanation
<b>Mode switching</b>	<p>You can switch to the mode you use.</p> <p>▶ <b>Select a mode.</b></p> <ul style="list-style-type: none"> <li>When 2in1 is activated, the display for selecting the mode appears also by pressing and holding  for at least one second with the Stand-by display shown, and entering your Terminal Security Code.</li> <li>When "Mode link" is activated, the confirmation display appears telling that the setting for "Receive avoidance set." is also changed.</li> </ul>
<b>Phonebook 2in1 setting</b>	<p>You can change Phonebook 2in1 Setting for the Phonebook entry stored in the FOMA phone.</p> <p>▶ <b>Select an item.</b></p> <p><b>Set to A</b> . . . . . Sets as the Phonebook entry for A. You can use it in A Mode and Dual Mode.</p> <p><b>Set to B</b> . . . . . Sets as the Phonebook entry for B. You can use it in B Mode and Dual Mode.</p> <p><b>Set to Common</b> . . . Sets as the common Phonebook entry for A and B. You can use it in all modes.</p> <p>▶ <b>Select a setting method.</b></p> <p><b>Set one</b> . . . . . Sets a Phonebook entry you call up.</p> <p><b>Set some</b> . . . Select multiple Phonebook entries from the Phonebook list you call up, then press  (Finish).</p> <p><b>Set group</b> . . . Sets a Phonebook group you call up.</p>
<b>Stand-by display</b>	<p>You can set the Stand-by display that appears in Dual Mode or B Mode.</p> <p>▶ <b>Select a mode ▶ Set the Stand-by display.</b></p> <ul style="list-style-type: none"> <li>See page 98 for how to set the Stand-by display. However, "  appli display" is not displayed.</li> <li>If you select "Release", the setting returns to the default.</li> </ul>

Item	Operation/Explanation
<b>Set call/receive No. (Disp. call/receive No.)</b>	<p>You can set the character font of phone numbers shown on the display for when you make/receive calls by Number B.</p> <p>▶ <b>Disp. call/receive No. ▶ Set a font.</b></p> <ul style="list-style-type: none"> <li>See page 110 for how to set the font.</li> </ul>
<b>Set call/receive No. (Ringtone set. for No. B)</b>	<p>You can set a ring tone for Number B and a mail ring tone for Address B.</p> <p>▶ <b>Ringtone set. for No.B ▶ Select an item.</b></p> <p><b>Phone</b> . . . . . Sets a ring tone for voice calls.</p> <p><b>Video-Phone</b> . . . . . Sets a ring tone for videophone calls.</p> <p><b>Mail</b> . . . . . Sets a ring tone for i-mode mail messages and SMS messages.</p> <p>▶ <b>Select a type of ring tone.</b></p> <p>Go to step 3 on page 92.</p> <ul style="list-style-type: none"> <li>If you select "Release", the setting returns to the default.</li> </ul>
<b>2in1 function OFF</b>	<p>You can deactivate 2in1.</p> <p>▶ <b>YES</b></p>
<b>Receive avoidance set. (Change recv. avoid.)</b>	<p>You can set Receive Avoidance Set. manually for Number A and Number B.</p> <p>▶ <b>Change recv. avoid. ▶ A number or B number</b></p> <p>▶ <b>Select an item.</b></p> <p><b>Unchange</b> . . . Does not change Receive Avoidance Set.</p> <p><b>Receive</b> . . . . . Receives the calls to the selected phone number.</p> <p><b>Avoid</b> . . . . . Avoids the calls to the selected phone number.</p> <p>▶  (Finish)</p> <ul style="list-style-type: none"> <li>When "Mode link" is activated, the confirmation display appears telling that it is necessary to deactivate it.</li> </ul>
<b>Receive avoidance set. (Check recv. avoidance)</b>	<p>You can check Receive Avoidance Set.</p> <p>▶ <b>Check recv. avoidance</b></p>

Item	Operation/Explanation
Receive avoidance set. (Mode link)	You can activate/deactivate Mode Link. When you activate it, Receive Avoidance Set. automatically changes by linking to switching of the mode of 2in1; You can receive a call only to Number A when in A Mode, only to Number B when in B Mode, and to both Number A and B when in Dual Mode. ▶ <b>Mode link ▶ YES</b>
Receive avoidance set. [Recv. avoid. (abroad)]	You can operate Receive Avoidance Set. from overseas. ▶ <b>Recv. avoid. (abroad) ▶ YES</b> ▶ <b>Operate following the voice guidance.</b> • When "Mode link" is activated, the confirmation display appears telling that it is necessary to deactivate it.

### Information

#### <Stand-by display>

- See "Set Stand-by Display" on page 98 to set the Stand-by display in A Mode.

#### <Set call/receive No. (Ringtone set. for No. B)>

- See "Select Ring Tone" on page 92 to set a ring tone for Number A and a mail ring tone for Address A.
- If a call comes in to Number B without notifying his/her caller ID, the ring tone set by "Call setting w/o ID" sounds.

#### <Receive avoidance set. (Mode link)>

- When "Mode link" is activated, you cannot switch the mode of 2in1 out of the service area.

## Make a Call in Dual Mode

In Dual Mode, Number A dialing is the default setting when you make a call from the Phonebook entry of A/common setting or the dialed/received call record of Number A, and Number B dialing is the default setting when you make a call from the Phonebook entry of B setting or the dialed/received call record of Number B. Further, you can select a phone number to be notified to the other party before making a call by the following operations.

### When Entering a Phone Number to Make a Call

**1** Enter a phone number ▶  or  (Dial)

**2** Number A or Number B

- To cancel, select "Cancel".

### When Selecting Your Caller ID from Phonebook or Call Records

**1** Bring up the detailed display of a Phonebook entry, redial item, dialed call record, or received call record.

**2**  (FUNC) ▶ 2in1 dial ▶ Number A or Number B

- To cancel, select "2in1 dial OFF".

■ Services available to each mode

● The items whose operations differ depending on the mode are listed. (Items that work the same way as with A Mode are omitted.)

Item		A Mode	B Mode	Dual Mode
Voice call	Dialing	Number A	Number B	Selectable when dialing**1
Videophone call	Receiving	Receiving all calls**2		
Phonebook**3	Displaying**4	Phonebook entries with A setting/ common setting	Phonebook entries with B setting/ common setting	All Phonebook entries
	Changing to name**5	Phonebook entries with A setting/ common setting	Phonebook entries with B setting/ common setting	All Phonebook entries
	2in1 setting when newly storing	Phonebook entries with A setting	Phonebook entries with B setting	Phonebook entries with A setting
	Receiving all entries using infrared rays/iC or from microSD card	Copying sender's 2in1 setting**6		
	Receiving one entry using infrared rays/iC or from microSD card	Phonebook entries with A setting	Phonebook entries with B setting	Phonebook entries with A setting
	"Copy to UIM"	At the time of "Copy to UIM", 2in1 setting becomes common		
	"Copy from UIM"	Phonebook entries with A setting	Phonebook entries with B setting	Phonebook entries with A setting
Redial	Displaying	Records for Number A/Address A	Records for Number B/Address B	All records
Dialed calls				
Received calls				
Received address records				
Detailed sent Chaku-moji message				
Mail/SMS	Displaying**7	<ul style="list-style-type: none"> <li>● Sent/Received mail messages for Address A</li> <li>● Sent/Received SMS messages for Number A</li> </ul>	<FOMA phone> <ul style="list-style-type: none"> <li>● Received mail messages saved to the FOMA phone for Address B [mail messages you performed "端末に保存 (save to the FOMA phone)" on Web mail site], notification mail for new mail, and alarm notification mail</li> <li>● Received SMS messages for Number B</li> </ul> <Web mail site> Sent/Received mail messages for Address B	<FOMA phone> <ul style="list-style-type: none"> <li>● Sent/Received mail messages for Address A, received mail messages saved to the FOMA phone for Address B, notification mail for new mail, and alarm notification mail</li> <li>● Sent/Received SMS messages for Number A</li> <li>● Received SMS messages for Number B</li> </ul> <Web mail site> Sent/Received mail messages for Address B

Item		A Mode	B Mode	Dual Mode
Mail/SMS	Sending	<ul style="list-style-type: none"> <li>Mail messages from Address A</li> <li>SMS messages from Number A</li> </ul>	<FOMA phone> Unable to send mail/SMS messages <Web mail site> Mail messages from Address B	<FOMA phone> <ul style="list-style-type: none"> <li>Mail messages from Address A**8</li> <li>SMS messages from Number A</li> </ul> <Web mail site> Mail messages from Address B
	Receiving	Mail messages to Address A/SMS messages to Number A (with ring tone/vibration) Mail messages to Address B that you performed the saving operation to the FOMA phone/Notification mail for new mail or alarm notification mail/SMS messages to Number B (without ring tone/vibration)	Mail messages to Address A/SMS messages to Number A (without ring tone/vibration) Mail messages to Address B that you performed the saving operation to the FOMA phone/Notification mail for new mail or alarm notification mail/SMS messages to Number B (with ring tone/vibration)	Mail messages to Address A/SMS messages to Number A (with ring tone/vibration) Mail messages to Address B that you performed the saving operation to the FOMA phone/Notification mail for new mail or alarm notification mail/SMS messages to Number B (with ring tone/vibration)
	Receiving all messages using infrared rays/iC or from microSD card	Copying sender's state**6		
	Receiving one message using infrared rays/iC or from microSD card	Mail for Address A/SMS messages for Number A		
	"Copy to UIM" (SMS only)	SMS messages for Number A		
	"Copy from UIM" (SMS only)	SMS messages for Number A	Undisplayable	SMS messages for Number A
i-oppli	All usable	Usable**9	Usable**10	
Own number	Number A	Number B	Number A/Number B	
Voice mail	Recording voice mail messages	Recording all voice mail messages**11		
	Connection number for the service**12	Number A	Number B**13	Selectable when dialing
Call forwarding	Forwarding to the forwarding destination	Forwarding all calls		
	Connection number for the service**12	Number A	Number B**14	Selectable when dialing

\*\*1 The Phonebook entry with A setting or common setting is dialed by Number A and the Phonebook entry with B setting is dialed by Number B by default.

\*\*2 When you set "Call acceptance" in A (B) Mode, you can receive calls only from the specified phone numbers in A/Dual (B/Dual) Mode, but you receive calls from all phone numbers in B (A) Mode.

When you set "Call rejection" in A (B) Mode, you can reject calls only from the specified phone numbers in A/Dual (B/Dual) Mode, but you receive calls from all phone numbers in B (A) Mode.

\*\*3 When you set a Phonebook entry as secret data, secret mode has priority.

\*\*4 Regardless of the mode, all the Phonebook entries on the microSD card are displayed.

- ※5 This function checks the phone number/mail address with the Phonebook, and changes it to the name of the Phonebook entry for displaying when the caller's phone number, receiver's phone number, sender's phone number, sender's mail address, or receiver's mail address is stored in the Phonebook.
- ※6 When the sender's model does not support 2in1, all data files are set with A setting.
- ※7 In B Mode, mail messages and SMS messages on the microSD card are not displayed if they do not have B Mode attribute information.
- ※8 When you compose a mail message in Dual Mode, you can select a receiver's mail address from the Phonebook entries set with B setting, however, note that the mail message is sent from Address A.
- ※9 Except message application programs, mail-linked i-ϕpli programs, and the i-ϕpli Stand-by display.
- ※10 Except the i-ϕpli Stand-by display.
- ※11 Up to 20 voice mail messages for Number A and Number B can be recorded in total.  
The icon such as "📞" appears when the voice mail messages for Number A are recorded, and the icon such as "📞" appears when the voice mail messages for Number B are recorded.
- ※12 You can activate/deactivate the service and make other settings for Number A and Number B respectively.
- ※13 When you execute "Check setting" of "Voice mail", the confirmation display appears asking which number you use for dialing, Number A or Number B.
- ※14 When you execute "Check setting" of "Call forwarding", the confirmation display appears asking which number you use for dialing, Number A or Number B.

### Information

- When you delete an image or melody set to a Phonebook entry with B setting or move it to the microSD card in A Mode (or a Phonebook entry with A setting in B Mode), the message telling that the file is set to another function does not appear.
- In B Mode, you cannot use the following mail functions:
 

· Composing i-mode mail/SMS messages	· Templates	· Photo-sending	· Receive option	· Forward
· Reply/Reply with quote	· Mail settings	· Chat mail	· Displaying Outbox/Draft	· Mail To function
· i-ϕpli To function from i-mode mail text				
- In Dual Mode, you cannot compose i-mode mail/SMS messages and use Photo-sending from a redial item/dialed call record for Number B and a received call record for Number B.
- In Dual Mode, you cannot execute "Reply" and "Reply with quote" from the mail/SMS message sent to Number B/Address B.
- When you perform following operations in Dual Mode, calls are made from Number A:
  - When you make a call from Pause Dial
  - When you make a call from Record Message
- Regardless of the current mode, emergency calls to 110/119/118 notify of Number A.
- When you make a call/AT command call from an external device, the call is made from Number A in A Mode and Dual Mode, and from Number B in B Mode.
- Regardless of the current mode, you can save up to 2,500 i-mode mail messages including SMS messages in the Inbox.
- The i-mode mail/SMS messages sent to Address B/Number B cannot be replied to, however, they are not saved to the folder set to "Reply impossible".
- "DEL all read mails", "DEL all recv. mails", "Delete read mails", "Delete all SMS-R", "DEL all frm folder", and "Delete all" apply to all the i-mode mail/SMS messages.
- Regardless of the current mode, "Delete all" of the Phonebook applies to all the Phonebook entries.

<OFFICEED>

## Using OFFICEED

“OFFICEED” is an in-group fixed bill service that applies to the specified IMCS (In-building Mobile Communication System).

The separate subscription is required for use.

For details, check the DOCOMO-enterprise-oriented web page (<http://www.docomo.biz/d/212/>). (Japanese only)

### Use OFFICEED Out-of-Area Forwarding Function

You can use the OFFICEED out-of-area forwarding function to forward OFFICEED calls to out-of-OFFICEED area.

- 1  **Service** **OFFICEED**  
▶ Do the following operations.



Item	Operation/Explanation
<b>Area display setting</b>	You can set whether to display “ <b>OFFICEED</b> ” while you are in the OFFICEED area. ▶ <b>ON or OFF</b> • If you select “ON”, the confirmation display appears asking whether to set Area Display Setting to “ON”.
<b>Activate forwarding</b>	You can activate the OFFICEED out-of-area forwarding function. ▶ <b>YES</b>
<b>Deactivate forwarding</b>	You can deactivate the OFFICEED out-of-area forwarding function. ▶ <b>YES</b>
<b>Check forwarding set.</b>	You can check the setting of the OFFICEED out-of-area forwarding function.

<Additional Service>

## Using Additional Services

When a new network service is provided by DOCOMO, you can register that service in the menu to use it.

### Add New Service

- 1  **Service** **Additional service** **Additional service**  
▶ **Highlight <Not stored> and press**  **( FUNC )**  
▶ **Add new service**
- You can change the setting for the registered service by pressing  **( FUNC )** and selecting “Edit”.
  - To delete the registered service, press  **( FUNC )** and select “Delete this” or “Delete all”, then select “YES” → “OK”.
  - You can register up to 10 network services.

- 2 **Enter a service name**  
▶ **Enter number or Enter USSD number**

Select either “Enter number” or “Enter USSD number” according to the service contents you add.

- You can enter up to 10 full-pitch/20 half-pitch characters.

- 3 **Enter either a special number or a service code (USSD number)** ▶ **YES**

#### Information

- You need to check and enter “Special number” or “Service code” supplied by DOCOMO for using the services.  
Special number  
... Number for connecting the Service Center.  
Service code (USSD number)  
... With the FOMA phone, enter it as USSD. The code is for notifying to the Service Center.





## Use Registered Service



- 1  ► **Service** ► **Additional service** ► **Additional service**  
► **Select a service** ►  ( **Send** )

Dialing to the Service Center starts.

## Register Additional Guidance

For when you execute the additional services, you can register up to 10 additional guidance items which correspond to the codes (USSD) that are returned from the Service Center. The additional guidance name is displayed when the registered command is returned as a reply.

- 1  ► **Service** ► **Additional service** ► **Additional guidance**  
► **Highlight <Not stored> and press**  ( **FUNC** )  
► **Add new guidance**

- You can check the setting by selecting the registered guidance.
- You can change the setting of the registered guidance by pressing  ( **FUNC** ) and selecting "Edit".
- To delete the registered guidance, press  ( **FUNC** ) and select "Delete this" or "Delete all", then select "YES" → "OK".

### 2 Enter a command.

- Enter the code (USSD) provided by DOCOMO.

### 3 Enter an additional guidance name ► YES

- You can enter up to 10 full-pitch/20 half-pitch characters.

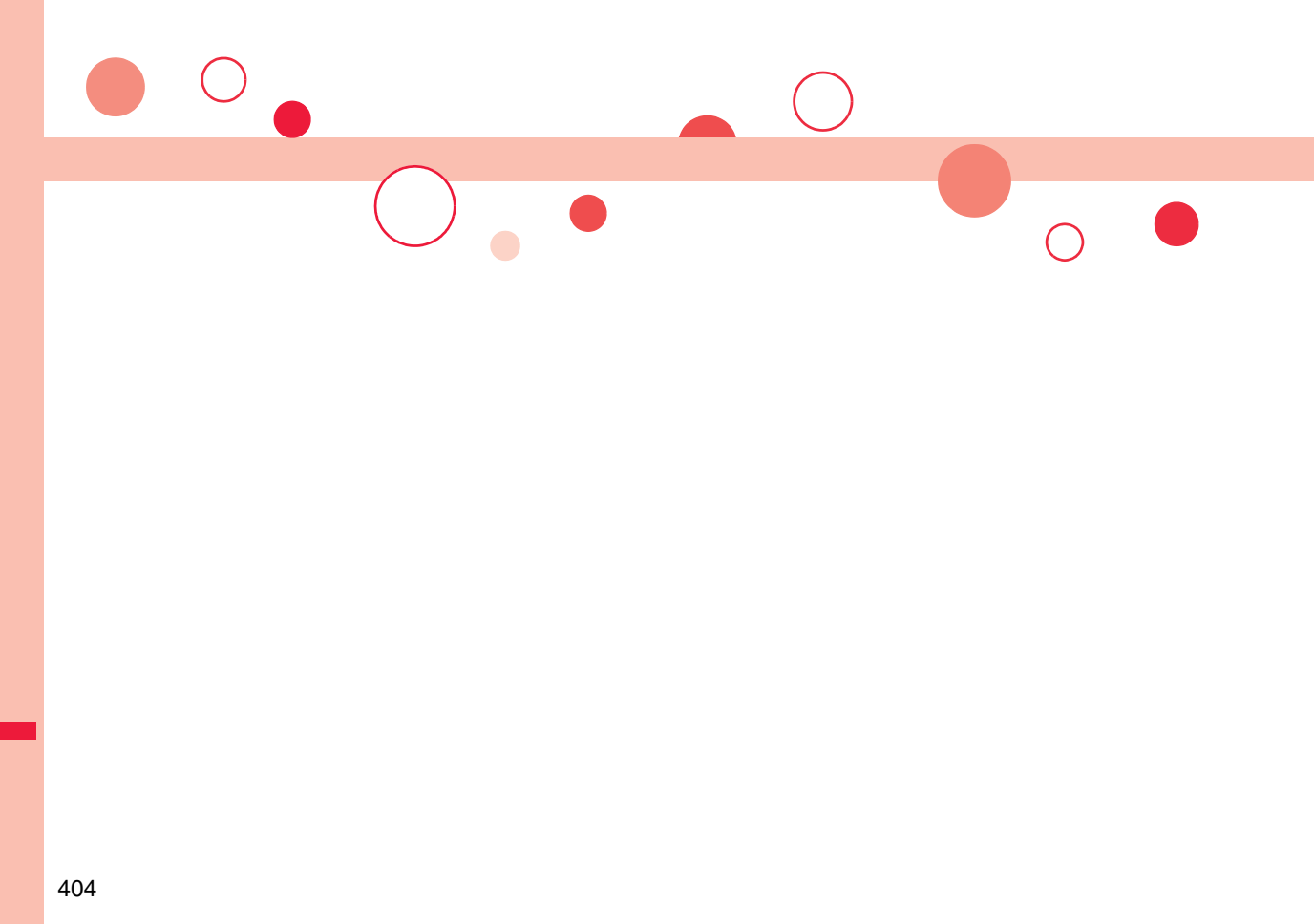

# PC Connection

Data Communication Available from FOMA Phone .....	406
Before Using Data Communication .....	407
Preparation Flow for Data Transfer (OBEX™ Communication) .....	408
Preparation Flow for Data Communication.....	409
AT Command .....	409
About CD-ROM.....	410
Introduction of DOCOMO Keitai Datalink .....	410

For details on data communication, refer to the PDF version of “Manual for PC Connection” on the provided CD-ROM or DOCOMO web page. To see the PDF version of “Manual for PC Connection”, you need to have Adobe® Reader®. If it is not installed in your personal computer, install Adobe® Reader® from the provided CD-ROM to see it. For details such as how to use it, refer to “Adobe Reader Help”.

## Data Communication Available from FOMA Phone

The data communication services you can use by connecting the FOMA phone to a personal computer are categorized into data transfer (OBEX™ communication), and packet communication/64K data communication. The FOMA phone is equipped with the adapter function for packet communication.

- You might not be able to activate or operate other functions during data communication. See "Multiaccess Combination Patterns" on page 448 for details.
- The 64K data communication is not available overseas.
- To perform the packet communication overseas, perform it via the IP connection. (You cannot perform the packet communication via the PPP connection.)

### Data Transfer (OBEX™ Communication)

You can exchange data files such as images, music files, Phonebook entries and mail messages with another FOMA phone or a personal computer.

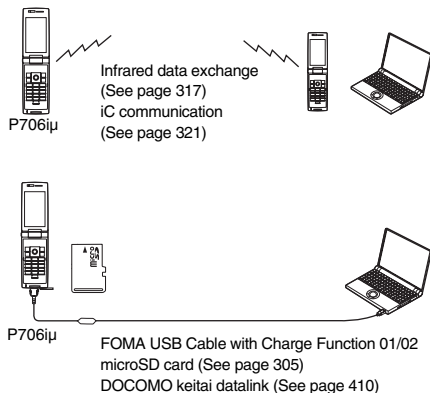

### Packet Communication

This service requires a communication fee according to the amount of data you sent and received. (Maximum download speed: 3.6 Mbps, Maximum upload speed: 384 kbps) It uses an access point which supports FOMA packet communication such as DOCOMO Internet access service "mopera U"/"mopera". To use this service, connect the FOMA phone to a personal computer via the FOMA USB Cable with Charge Function 01/02 (option), and then carry out settings. The packet communication is suitable for using applications through the high-speed communication.

- The packet communication is charged according to the amount of data you sent and received. Note that you are charged a high communication fee for the massive data communication such as browsing Internet web pages having many images or downloading data files.
- The data is sent/received at the maximum speed of 384 kbps outside the FOMA High-speed Area.
- When you use the packet communication with "sigmarion II", "sigmarion III", or "musea" of DOCOMO's PDA, the data is sent/received at the maximum speed of 384 kbps. High-speed communication for FOMA High-speed Area is not supported.

### 64K Data Communication

This service requires a communication fee according to the duration of connection. By connecting the FOMA phone to a personal computer via the FOMA USB Cable with Charge Function 01/02 (option), you can execute communication. To use this service, connect to an access point which supports FOMA 64K data communication such as DOCOMO Internet access service "mopera U"/"mopera", or an ISDN-synchronous 64K access point.

- The 64K data communication is charged according to the duration of connection. Note that a communication fee becomes expensive if you use this service for a long time.

### Information

- The FOMA phone does not support Remote Wakeup.
- The FOMA phone does not support the FAX communication.
- You can perform data communication by connecting the FOMA phone with DOCOMO's PDA "sigmarion II", "sigmarion III", or "musea". To use "sigmarion II" or "musea", the update is required. For details such as how to update them, refer to the DOCOMO web page.

## Before Using Data Communication

### Charge of Internet service provider

To use the Internet, you need to pay the charge for the Internet service provider you use. Besides the FOMA service fee, you need to directly pay this charge to the Internet service provider. For details on the charge, contact the Internet service provider you use.

You can use the DOCOMO Internet access service, "mopera U"/ "mopera". To use "mopera U", subscription (charged) is required. To use "mopera", subscription and monthly charge are not required. However, the maximum communication speed of sending/receiving data is limited to 384 kbps.

### Setting access point (Internet service provider, etc.)

The access points for the packet communication and 64K data communication differ. To use the packet communication, connect to an access point which supports packet communication. To use the 64K data communication, connect to an access point which supports FOMA 64K data communication or ISDN-synchronous 64K.

- You cannot connect to the DoPa access point.

### About user authentication for accessing network

User authentication (ID and password) may be required at connection to some access points. In this case, enter your ID and password on the communication software program (dial-up network). ID and password are specified by the Internet service provider or network administrator of the access point. For details, contact the provider or network administrator.

### About access authentication for using browser

If you need FirstPass (user certificate), install the FirstPass PC software from the provided CD-ROM and make the setting.

For details, refer to "FirstPassManual" (PDF format) in the "FirstPassPCSoft" folder on the CD-ROM. Adobe® Reader® (version 6.0 or higher is recommended) is required to see "FirstPassManual" (PDF format). If it is not installed in your personal computer, install Adobe® Reader® from the provided CD-ROM to see it. For details such as how to use it, refer to "Adobe Reader Help".

### Conditions of packet communication and 64K data communication

To carry out the communication by using the FOMA phone in Japan, the following conditions are required:

- The personal computer to be used can use the FOMA USB Cable with Charge Function 01/02 (option).
- The PDA to be used should support FOMA packet communication and 64K data communication.
- Within the FOMA service area
- For packet communication, the access point should support packet communication of the FOMA.
- For 64K data communication, the access point should support the FOMA 64K data communication or ISDN-synchronous 64K.

Even when these conditions are satisfied, if the base station is congested or the radio wave conditions are bad, you may not carry out the communication.

## Operating Environment

For the data communication, the following operating environment is required for your personal computer:

### ■ PC main unit

PC/AT compatible model

When using the FOMA USB Cable with Charge Function 01/02 (option):

USB port (Universal Serial Bus Specification Rev1.1 compliant)

Display resolution 800 x 600 dots, High Color 16 bits or more recommended.

### ■ OS

Windows 2000, Windows XP, Windows Vista (Japanese version in each)

### ■ Memory requirements

Windows 2000: 64 Mbytes or more

Windows XP: 128 Mbytes or more

Windows Vista: 512 Mbytes or more

### ■ Hard disk space size

Unused memory space of 5 Mbytes or more

- The operation on the upgraded OS is not guaranteed.
- The memory requirements and hard disk space size may vary depending on the system environment.

## Necessary Devices

The following hardware and software programs are required besides the FOMA phone and personal computer:

- FOMA USB Cable with Charge Function 01/02 (option) or FOMA USB Cable (option)
- Provided "FOMA P706jμ CD-ROM"

### Information

- Use a dedicated "FOMA USB Cable with Charge Function 01/02" or "FOMA USB Cable". The USB cable for personal computers cannot be used because the shape of the connector differs.
- If you use a USB hub, the devices may not work correctly.

## Connect FOMA Phone to Other Devices

The following two ways are available for connecting the FOMA phone to another device:

### Use FOMA USB Cable with Charge Function 01/02

Connect the FOMA phone to a personal computer provided with the USB port using the FOMA USB Cable with Charge Function 01/02 (option).

This way of connection applies to all types of communications such as packet communication, 64K data communication, and data transfer.

- Set "USB mode setting" to "Communication mode". (See page 313)
- You need to install the "FOMA communication setup files" (driver) before use.

### Use Infrared Data Exchange

By using infrared rays, you can send/receive data between your FOMA phone and another FOMA phone, mobile phone, or personal computer provided with the infrared data exchange function. (See page 317)

This applies only to data transfer.

## Preparation Flow for Data Transfer (OBEX™ Communication)

When you use the FOMA USB Cable with Charge Function 01/02 (option), install the "FOMA communication setup files" (driver).

Download and install the "FOMA communication setup files" (driver).

- Install the FOMA communication setup files from the provided CD-ROM or download them from the DOCOMO web page and install.



Data transfer

## Preparation Flow for Data Communication

The following outline shows a preparation flow for packet communication or 64K data communication:

For details, refer to the PDF version of “Manual for PC Connection”.

Connect a personal computer to the FOMA phone using the FOMA USB Cable with Charge Function 01/02 (option).



Download and install the “FOMA communication setup files” (driver).  
• Install the FOMA communication setup files from the provided CD-ROM or download them from the DOCOMO web page and install.



Check the setting after installation.



Install the “FOMA PC setup software”.

Carry out the setting manually without using the “FOMA PC setup software”.



Connect.

### When installing “FOMA communication setup files” (driver)

Install the FOMA communication setup files from the provided “FOMA P706ij CD-ROM” or download them from the DOCOMO web page and install. You are advised to install “FOMA PC setup software” for establishing the APN or dial-up setting easily when you communicate.

### Install FOMA Communication Setup Files (Driver)

Installing the FOMA communication setup files (driver) is required when you connect the FOMA phone to your personal computer via the FOMA USB Cable with Charge Function 01/02 (option) for the first time.

### FOMA PC Setup Software

To connect the FOMA phone to a personal computer and perform the packet communication or 64K data communication, you need to configure various settings for the communication. By using the “FOMA PC setup software”, you can easily carry out the settings. If required, you can set the packet communication and 64K data communication without using the “FOMA PC setup software”.

### AT Command

AT commands are used to specify and modify the functions of the FOMA phone on the personal computer.

## About CD-ROM

The provided CD-ROM contains the software programs for using data communication on your FOMA phone, "Manual for PC Connection" and "Kuten Code List" (PDF file). For details, refer to the provided CD-ROM.

<Contained software programs/PDF>

- ・ FOMA通信設定ファイル (FOMA Communication Setup Files)
- ・ FOMA PC設定ソフト (FOMA PC Setup Software)
- ・ FOMA/バイトカウンタ (FOMA byte counter)
- ・ ドコモケータイdatalinkのご案内 (DOCOMO keitai datalink information)
- ・ i モード.net 新着確認ツールのご案内 (i-mode.net notifier information)
- ・ FirstPass PCソフト (FirstPass PC Software)
- ・ mopera Uのご案内 (mopera Uかんたんスタート/Uかんたん接続設定ソフト/  
FOMA/バイトカウンタル オリジナルデータ取得ソフト)  
[mopera U information (mopera U start up tool/mopera U connection & setting tool/  
FOMA byte counter/mopera U requesting original data)]
- ・ ナップスター®のご案内 (Napster® information)
- ・ PDF version of "パソコン接続マニュアル"/"Manual for PC Connection"
- ・ PDF version of "区点コード一覧"/"Kuten Code List"
- ・ Adobe® Reader®

## When a warning message appears

When you set the CD-ROM on your personal computer, an alert message might appear on the display as shown below. This alert message appears depending on the security settings of Internet Explorer, however, you can use your computer without any problem. Click "はい (YES)".

※ The display below is for when you use Windows XP.

It might differ depending on the environment of the computer you use.



## Introduction of DOCOMO Keitai Datalink

"DOCOMO keitai datalink" is the software program that enables you to back up your Phonebook entries, i-mode mail messages and others to your personal computer and edit them. The software program is distributed from the DOCOMO web page. For details and how to download, refer to the web page below. You can access the web page below from the provided CD-ROM as well.

<http://datalink.nttdocomo.co.jp/> (Japanese only)

- For details on how to download, transferable data, operating environments such as compatible OS, installation method, operating method, and restrictions, refer to the web page above. For operations after installation, refer to Help contained in the software program. To use the DOCOMO keitai datalink, you need to separately have the USB Cable (option).



# Overseas Use

Outline of International Roaming (WORLD WING) . . . . .	412
Services Available Overseas . . . . .	412
Confirmation for Using . . . . .	413
Making a Call at the Country You Stay . . . . .	415
Receiving a Call . . . . .	416
Setting a Search Method of Carrier . . . . . <Network Search Mode>	417
Setting a Carrier to Preferentially Connect to . . . . . <PLMN Setting>	417
Displaying a Carrier Name on the Stand-by Display . . . . . <Operator Name Display>	418
Confirming a Communication System . . . <Status in the Area>	418
Setting Guidance during Roaming . . . . . <Set Roaming Guidance>	418
Setting Your FOMA Phone to Reject Calls during Roaming . . . . . <Call Barring>	419
Using Network Services during Roaming . . . . .	419

## Outline of International Roaming (WORLD WING)

**International Roaming (WORLD WING) is a service that enables you, using local carrier's networks, to make calls or to communicate in foreign countries where are out of the service area of the FOMA network.**

- There are following three communication systems for network services overseas. You can use this FOMA phone in the 3G roaming area. (You cannot use this FOMA phone in the service area of GSM/GPRS.):

### 3G Network

Third generation mobile communications system that conforms to the world standard specifications, 3GPP (Third Generation Partnership Project).\*

※ This is the regional standards organization for developing common technical specifications for third-generation mobile telecommunication systems (IMT-2000).

### GSM (Global System for Mobile Communications) Network

The most widespread 2G digital mobile standard system available worldwide.

### GPRS (General Packet Radio Service) Network

A 2.5G mobile standard system enabling high-speed packet communications by GPRS using GSM communication method.

- At the time of purchase, the FOMA phone is set to automatically switch networks in foreign countries. (See page 417)
- You are advised to read the following booklets before using your FOMA phone overseas:

Booklet title	Contents
Mobile Phone User's Guide [International Services]	Describes the details of International Roaming Service such as the contents of the service, billing, and cautions.
Mobile Phone User's Guide [Network Services]	Describes the contents of each local network service and cautions.

### Information

- Quick Manual "For Overseas Use" is attached to the end of this manual. Refer to it when you use the FOMA phone overseas.
- For the country codes, international call access codes, and international prefix numbers for the universal number, refer to "Mobile Phone User's Guide [International Services]" or the DOCOMO Global Service web page.

### Information

- Overseas use fee is added to your monthly bill. You might be requested, however, to pay according to the invoice for the following month on and after depending on the overseas carrier of your stay. Note that the invoice for the total of the fees to be paid for the month might be separately issued.

## Services Available Overseas

### ■ Voice call\*\*1

In the country you stay, you can use the phone number as used in Japan to make or take local calls, or to make international calls to Japan or to other countries.

### ■ Videophone call\*\*1

You can make international videophone calls to users of the specified 3G mobile phone carriers overseas and FOMA users.

### ■ i-mode

Perform the overseas usage settings.

For details, refer to "Mobile Phone User's Guide [i-mode] FOMA version".

### ■ i-mode mail

You can send/receive i-mode mail overseas by the same address as used in Japan.

### ■ SMS

### ■ i-Channel\*\*2

### ■ Packet communication by connecting with a personal computer

※1 In B Mode or Dual Mode of 2in1, you cannot make calls from Number B.

※2 Auto-updates are automatically suspended when you are connected to an overseas carrier. To resume the auto-updates of i-Channel, you need to make the i-Channel settings again. When you use i-Channel overseas, the communication fee for auto-updates of the basic channel also applies. (In Japan, the fee is included in the monthly service bill.)

- The 64K data communication is not available overseas.
- You cannot dial from an additional number even if you are the user of Multi Number.
- Some services are not available depending on the carrier or network. For connectable countries, regions, and carriers, refer to the DOCOMO Global Service web page.

## Confirmation for Using

### Confirmation before Departure

Confirm below in Japan before you use the FOMA phone overseas.

#### ■ About contract

- You do not need to subscribe to WORLD WING if you have subscribed to the FOMA service after September 1, 2005. If you offered that you do not need WORLD WING at the time you signed up for the FOMA service, or when you have canceled WORLD WING midway, you are required to newly subscribe to WORLD WING.
- If you have signed up for the FOMA service before August 31, 2005, and have not yet subscribed to WORLD WING, you are required to subscribe to it.
- Insert the UIM (other than blue one) that supports "WORLD WING" into the FOMA phone. (See page 37)
- This service is not available with some billing plans.

#### ■ About charging batteries

- See page 19 for cautions for handling AC adapter (option).
- See page 40 and page 41 for charging batteries using AC adapter (option).

#### ■ About the setting of network service

When you have signed up for network services, you can release/make the settings (except some) of the network services also from overseas.

- Even with the network services that you can operate to activate/deactivate, you might not be able to use the services depending on the overseas carrier. Also, some network services are available only in Japan.

To use network services overseas, refer to "Mobile Phone User's Guide [International Services]" or "Mobile Phone User's Guide [Network Services]" before departure.



#### ■ About SMS

Even during international roaming, you can send/receive SMS messages to and from the other party who uses the FOMA phone in Japan or overseas or who uses overseas carriers.

- When you enter the destination address for sending an SMS message to the other party who is using an overseas carrier, add "+" and a country code to the head of the destination phone number. When the destination phone number begins with "0", however, enter the phone number except for the "0". However, include "0" when making a call to some countries or regions such as Italy.
- When the text of an SMS message sent to the other party who is using an overseas carrier contains characters that do not support those on the destination phone, the characters might not be correctly displayed. For details, refer to "Mobile Phone User's Guide [International Services]" or "Mobile Phone User's Guide [Network Services]".

## Check Required at the Country You Stay

After you arrive at the country overseas, once turn the power off and then turn on to automatically set an available carrier in that country.

- The network system you are currently using appears at the upper side of the display.
  -  : 3G network that supports packet communication
  -  : 3G network that does not support packet communication
- When "Operator name display" is set to "Display ON", the name of the connected carrier appears on the Stand-by display.
- When "Network search mode" is set to "Auto", and you move out of the service area of the network you are connected to, the available network of another carrier is automatically searched for and you are re-connected to it.

#### ■ About inquiries

For lost, stolen, and cost settlement, or malfunction of your FOMA phone overseas, refer to "Loss or theft of FOMA terminal or payment of cumulative cost overseas" or "Failures encountered overseas" on the back page of this manual. Note that you are still charged the call and communication fees incurred after you lose it or have it stolen.

- You need to add the "international call access code" that is assigned to the country you stay or "international prefix number for the universal number" to the head of each phone number for inquiries.
- For the latest information about the international call access codes and international prefix numbers for the universal number, refer to the DOCOMO Global Service web page.

### ■ Country codes for major countries

Use the following country codes when you make international calls or when you set Int'l Dial Assist. (As of June 2008)

Service area	Code	Service area	Code
Australia	61	Monaco	377
Belgium	32	Netherlands	31
Brazil	55	New Zealand	64
Canada	1	Norway	47
China	86	Philippines	63
Czech Republic	420	Poland	48
Denmark	45	Portugal	351
Finland	358	Russia	7
France	33	Singapore	65
Germany	49	South Korea	82
Greece	30	Spain	34
Hong Kong	852	Sweden	46
Hungary	36	Switzerland	41
India	91	Taiwan	886
Indonesia	62	Thailand	66
Ireland	353	Turkey	90
Italy	39	United Arab Emirates	971
Luxembourg	352	United Kingdom	44
Macau	853	United States of America	1
Malaysia	60	Vietnam	84

● For the code for the countries other than listed in the table, or for details, refer to the DOCOMO Global Service web page.

### ■ International call access codes for major countries (Table 1)

The international call access codes for major countries are listed below. (As of March 2008)

Service area	Access code	Service area	Access code
Australia	0011	Monaco	00
Belgium	00	Netherlands	00
Brazil	0021/0014	New Zealand	00
Canada	011	Norway	00
China	00	Philippines	00
Czech Republic	00	Poland	00
Denmark	00	Portugal	00
Finland	00	Russia	810
France	00	Singapore	001
Germany	00	South Korea	001
Greece	00	Spain	00
Hong Kong	001	Sweden	00
Hungary	00	Switzerland	00
India	00	Taiwan	002
Indonesia	001	Thailand	001
Ireland	00	Turkey	00
Italy	00	United Arab Emirates	00
Luxembourg	00	United Kingdom	00
Macau	00	United States of America	011
Malaysia	00	Vietnam	00

## International prefix numbers for the universal number (Table 2)

The international prefix numbers for the universal number for major countries are listed below. (As of March 2008)

Service area	International prefix number	Service area	International prefix number
Argentina	00	Luxembourg	00
Australia	0011	Malaysia	00
Austria	00	Netherlands	00
Belgium	00	New Zealand	00
Brazil	0021	Norway	00
Bulgaria	00	Peru	00
Canada	011	Philippines	00
China	00	Portugal	00
Colombia	009	Singapore	001
Denmark	00	South Africa	09
Finland	990	South Korea	001
France	00	Spain	00
Germany	00	Sweden	00
Hong Kong	001	Switzerland	00
Hungary	00	Taiwan	00
Ireland	00	Thailand	001
Israel	014	United Kingdom	00
Italy	00	United States of America	011

- The numbers are not available in some areas.
- You can use the universal numbers only in countries listed in the table above.
- When making a call from a hotel, you may be separately charged the phone usage fee from the hotel. (You are responsible for the fee.) You should check with the hotel before making a call.
- Note that, in many cases, the universal number may not be used from a mobile phone, public phone, or hotel phone, etc.

## Check Required after Homecoming

After you return to Japan, the FOMA network is automatically searched and connected.

Set “Network search mode” to “Auto”, or set to the FOMA network (DoCoMo) with “Manual”.

## Making a Call at the Country You Stay

You can make voice calls or videophone calls from overseas using international roaming service.

## Make a Call to Outside the Country You Stay (Including Japan)

### Use Phonebook to Make an International Call to Japan

When you make an international call from the country you stay to a landline phone or mobile phone in Japan, you can operate from the Phonebook easily.

- This is available only when the phone number stored in the Phonebook begins with “0”. You need to set “Auto assist setting” of “Int'l dial assist” to “ON” and to “Japan (81)” in advance. (Setting at purchase)

### 1 Detailed Phonebook display or

- Press  (V. phone) to make an international videophone call.

### 2 Dial

“0” at the head of the phone number is replaced with “+81” when dialed.

- When you select “Original phone No.”, the phone number is dialed as stored in the Phonebook.

### Information

- From a redial item or dialed call record, or by entering a phone number directly, you can make an international call by the same operation.

## Use “+” to Make an International Call

Press and hold  for at least one second, then you can enter “+” when dialing. By using “+”, you can make international calls from the country you stay to the countries such as Japan.

### 1 (for at least one second)

▶ Enter numbers in order of country code

→ area code (city code) → destination phone number

▶  or  (Dial)

- Enter “81” as a country code when you make an international call to Japan.
- When the area code (city code) begins with “0”, enter it except for the “0”. However, include “0” when making a call to some countries or regions such as Italy.
- Press  (V. phone) to make an international videophone call.

## International Dial

If you have stored a country code by Country Code Setting (see page 59), you can make international calls from the country you stay to the country such as Japan. The following are the procedures for overseas.

### 1 Enter a phone number

or

bring up the detailed display of a Phonebook entry, redial item, dialed call record, or received call record.

### 2 (FUNC) ▶ Int'l dial assist

▶ Select a country name ▶  or  (Dial)

- Press  (V. phone) to make an international videophone call.

## Make a Call to a Phone in the Country You Stay

In the same way as you do in Japan, you can make a voice call or videophone call by entering the destination's phone number.

### 1 Enter a destination phone number ▶ or (Dial)

- Press  (V. phone) to make a videophone call.
- To make a call in the country you stay using the Phonebook, select “Original phone No.” in step 2 on page 415.

## Make a Call to a Person who is Staying Overseas and Using WORLD WING

When you make a call to a person who is also internationally roaming, make the call in the same way as to make international calls to Japan even if he/she is in the country you stay.

## Receiving a Call

In the same operation as you do in Japan, you can answer voice calls and videophone calls overseas. (See page 62)

### ■ Having calls to your FOMA phone made from Japan

You can receive international calls from Japan by just having your phone number entered in the same way as the callers usually do in Japan.

**Making a call entering “090 (or 080) -XXXX-XXXX”**

### ■ Having calls to your FOMA phone made from countries other than Japan

Regardless of the country you stay, you receive calls via Japan; therefore, have the caller enter “international call access code of his/her country” and “81” (Japan) in the same way as the caller makes a call to Japan and then enter your phone number whose “0” is excluded from the head.

**Making a call entering “international call access code of the country of the caller-81-90 (or 80) -XXXX-XXXX”**

## Information

- Even for incoming calls, you are charged a receiving fee including an international forwarding fee, depending on the country or region.
- Even when a caller tried to notify of his/her caller ID, it might not be notified depending on the overseas carrier. Also, a different number from the other party's caller ID might be notified depending on the caller's network.
- While you use the FOMA phone overseas, “Call setting w/o ID”, “Reject unknown”, and “Restrictions (except Restrict Dialing)” might not work. In addition, it might work as “Answer” regardless of the setting of “Arrival call act”.
- When a call comes in during international roaming, the call is forwarded from Japan regardless of whatever country the call is from. The caller is charged a call fee to Japan and the receiver is charged a receiving fee including an international forwarding fee.

## Setting a Search Method of Carrier

You can set whether to automatically search a network and connect to another carrier when you move out of the service area.

- 1** ► **Settings** ► **Network setting** ► **Int'l roaming** ► **Network search mode** ► **Select an item.**

**Auto** . . . . . Automatically re-connects to another carrier. The setting is completed.

**Manual** . . . . . Connect manually to a carrier on the list.

"X" is displayed for unavailable carriers.

### Network re-search

. . . . . When set to "Auto", automatically switches to an available carrier. The setting is completed.

When set to "Manual", displays the list of carriers.

- 2** **Select a carrier.**

- Press to display the list of carriers again.

### Information

- You cannot set this function if the UIM is not inserted.
- When you move out of the service area while this function is set to "Manual", "Ⓢ" appears.
- When you have set this function to "Manual" and turn off and on the FOMA phone out of the service area, select a carrier again in the service area.

## Setting a Carrier to Preferentially Connect to

You can specify the priority order of carriers you are connected to for when "Network search mode" is set to "Auto". You can store up to 20 carriers.

- 1** ► **Settings** ► **Network setting** ► **Int'l roaming** ► **PLMN setting**

- You can select the stored carrier to check the stored contents.

- 2** ► **PLMN list select**

- To search for a carrier by a name of country, press **Search** and select a country name. You can search also by pressing **Search** again from the Country list and entering a country name.

- 3** **Select a carrier** ► **Set** ► **Finish** ► **YES**

### Function Menu while PLMN Setting is Displayed

Function menu	Operation/Explanation
<b>Set VPLMN to UPLMN</b>	You can store the carrier you are currently connected to. ► <b>Finish</b> ► <b>YES</b>
<b>PLMN list select</b>	See "Setting a Carrier to Preferentially Connect to" on page 417.
<b>PLMN manual select</b>	You can store a carrier by entering a country code and operator code. You can store carriers not found in the list. ► <b>Enter a country code (3 digits) and operator code (2 to 3 digits)</b> ► <b>Finish</b> ► <b>YES</b>
<b>Change priority</b>	► <b>Select a number to change to</b> ► <b>Finish</b> ► <b>YES</b>
<b>Delete this</b>	► <b>YES</b> ► <b>Finish</b> ► <b>YES</b>
<b>Delete all</b>	► <b>YES</b> ► <b>Finish</b> ► <b>YES</b>

## Information

- When the "DoCoMo" network is available, you are preferentially connected to it regardless of this setting.
- This setting is stored on the UIM.
- You cannot set this function if the UIM is not inserted.

### <Operator Name Display>

## Displaying a Carrier Name on the Stand-by Display

You can select whether to display, on the Stand-by display, the name of the carrier you are currently connected to.

- 1  Settings ▶ Network setting ▶ Int'l roaming ▶ Operator name display ▶ Display ON or Display OFF

### When you set to "Display ON"

The carrier's name is displayed on the Stand-by display. However, when you use the "DoCoMo" network, the carrier is not displayed.

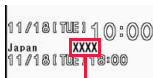

Carrier's name

### <Status in the Area>

## Confirming a Communication System

You can display whether the carrier you are currently connecting to supports the circuit switching (CS)<sup>※1</sup> and packet switching (PS)<sup>※2</sup>.

※1 The communication system used for voice calls, videophone calls, SMS, etc.

※2 The communication system used for i-mode, i-mode mail, etc.

- 1  Settings ▶ Network setting ▶ Status in the area

### <Set Roaming Guidance>

## Setting Guidance during Roaming

For an incoming voice call or videophone call during international roaming, you can have the voice guidance played back to the caller to that effect.

- Even when you activate Roaming Guidance, the caller may hear the guidance in a foreign language depending on the overseas carrier.
- Even when you deactivate Roaming Guidance, the caller hears a calling tone set by the overseas carrier.
- You need to set this function in Japan.

- 1  Service ▶ Set Roaming guidance ▶ Do the following operations.

Item	Operation/Explanation
Activate	▶ YES
Deactivate	▶ YES
Check setting	You can check the setting contents of "Set Roaming guidance". ▶ YES



## <Call Barring>

# Setting Your FOMA Phone to Reject Calls during Roaming

- This setting might not be available depending on the overseas carrier.

**1**  **Settings** ▶ **Network setting** ▶ **Int'l roaming**  
▶ **Call barring** ▶ Do the following operations.

Item	Operation/Explanation
Activate	<p>▶ Select an item.</p> <p><b>Bar all incoming</b> . . . . . Bars all calls including voice calls and videophone calls.</p> <p><b>Bar VP call/data ex.</b> . . . . . Bars only videophone calls.</p> <p>▶ <b>YES</b> ▶ Enter your <b>Network Security Code</b>.</p> <ul style="list-style-type: none"><li>• See page 114 for the Network Security Code.</li></ul>
Deactivate	<p>▶ <b>YES</b> ▶ Enter your <b>Network Security Code</b>.</p> <ul style="list-style-type: none"><li>• See page 114 for the Network Security Code.</li></ul>
Check setting	<p>You can check the setting contents of "Call barring".</p> <p>▶ <b>YES</b></p>

## Using Network Services during Roaming

You can use some network services such as Voice Mail Service or Call Forwarding Service from overseas.

You can set Roaming Guidance as well.

- See page 398 for "Receive avoidance set." of 2in1.

### Operate Voice Mail Service at the Country You Stay

**1**  **Settings** ▶ **Network setting** ▶ **Int'l roaming**  
▶ **Voice mail (Int.)** ▶ Select an item ▶ **YES**  
▶ Operate following the voice guidance.

### Operate Call Forwarding Service at the Country You Stay

**1**  **Settings** ▶ **Network setting** ▶ **Int'l roaming**  
▶ **Call forwarding (Int.)** ▶ Select an item ▶ **YES**  
▶ Operate following the voice guidance.

### Operate Roaming Guidance at the Country You Stay

**1**  **Settings** ▶ **Network setting** ▶ **Int'l roaming**  
▶ **Roaming guidance (Int.)** ▶ **YES**  
▶ Operate following the voice guidance.

### Operate Remote Control at the Country You Stay

**1**  **Settings** ▶ **Network setting** ▶ **Int'l roaming**  
▶ **Remote control (Int.)** ▶ **YES**  
▶ Operate following the voice guidance.

## Operate Caller ID Request Service at the Country You Stay

- 1  ► Settings ► Network setting ► Int'l roaming  
► Caller ID req. (Int.) ► YES  
► Operate following the voice guidance.

### Information

- When you use those services from overseas, you are charged an international call fee of the country you stay.
- You need to set "Remote control" beforehand.
- For the details on network services, refer to "Mobile Phone User's Guide [International Services]" and "Mobile Phone User's Guide [Network Services]".

# Appendix/External Devices/Troubleshooting

Function List .....	422
List of Characters Assigned to Keys (5-touch Input Method) .....	439
List of Characters Assigned to Keys (2-touch Input Method) .....	440
List of Characters Assigned to Keys (NIKO-touch Input Method) .....	441
Symbol List .....	442
Pictograph List .....	445
Common Phrase List .....	447
Multiaccess Combination Patterns .....	448
Multitask Combination Patterns .....	449
Services Available with FOMA Phones .....	451
Introduction of Options and Related Equipment .....	452
<b>Interfacing to External Devices</b>	
Introduction of Software for Playing Back Moving Images ....	452
Links with AV Equipment .....	452
<b>Troubleshooting</b>	
Troubleshooting .....	453
Error Messages .....	454
Warranty and Maintenance Services .....	463
i-mode Trouble Diagnosis Site .....	464
Updating Software .....	<Software Update> 465
Protecting FOMA Phone from Data Causing Failure .....	<Scanning Function> 471
Specifications .....	473
Number of Savable/Storable/Protectable Items in FOMA Phone .....	474
SAR Certification Information and Other Information .....	475
Export Administration Regulations .....	476







## Function List

Execute “Reset settings” on page 373 for the items indicated by , and “Reset TV settings” on page 264 for the items indicated by ※, to return to the respective defaults. If you execute “Initialize” on page 373, all items return to the defaults.

● Even if you execute “Initialize”, the pre-installed i-appli programs you have deleted are not restored.

Main menu item	Sub-menu item	Lower sub-menu item	Setting at purchase	Reference	
Mail	Inbox		No mail messages, Messages R/F (except inside the UIM) User created folder: None      i-appli mail folder: None	190	
	Outbox		No mail messages (except inside the UIM) User created folder: None      i-appli mail folder: None	190	
	Draft		No mail messages (except inside the UIM)	191	
	Compose message		—	174	
	Template		Pre-installed data only	181	
	Web mail		—	217	
	Check new message		—	187	
	Compose SMS		—	214	
	Check new SMS		—	216	
	Chat mail		 Chat member: Not recorded (except “Own”)	210	
	Receive option		—	186	
	Mail settings	Scroll		1 line	204
		Character size		Standard	111
		Mail list display		List display: Date+sender/receiver subject      Message/Name in phonebook: Checked	204
		Message display		Standard	204
		Mail security		All unchecked	121
		Secret mail display		ON	121
		Auto color label		Not stored	204
		Pred. conv. at reply		ON	204
		Header/signature		Header: Blank      Insert: Checked	205
			Signature: Blank      Insert: Checked	205	
			Quotation marks: >	205	
Set check new message			All checked	204	
Auto-display			MessageR preferred	206	
Receiving display			Alarm preferred	205	
Receive option setting		OFF	186		
Attachment preference		All checked	205		
Auto melody play		ON	205		

Main menu item	Sub-menu item	Lower sub-menu item	Setting at purchase	Reference
Mail	Mail settings	Photo auto display	ON	205
		Chat setting	Sound setting: Alarm 1	213
			Chat image: ON	213
			User setting      Name: Own      Image: Apple	213
	Check settings	—	205	
	SMS settings	SMS report request	OFF	216
		SMS validity period	3 days	216
		SMS input character	Japanese (70char.)	217
		SMS center selection	DoCoMo	217
	Area mail settings	Receive setting	No	209
		Receive entry	Emergency information	209
		Beep setting	ON	209
		Beep time	10 seconds	209
i-mode	☰ Menu	—	150	
	Bookmark	Not stored User created folder: None	156	
	Screen memo	Not stored User created folder: None	158	
	Last URL	☰ Menu	154	
	Go to location	No URL histories	155	
	Message R/F	No messages	207	
	i-Channel	Channel list	—	172
		Ticker ON/OFF	ON	172
		Ticker font size set.	Standard	111
		Ticker color set.	Pattern 1	172
		Ticker scroll speed	Normal	172
		Reset i-Channel	—	172
	Check new message	—	187	
	Operate certificate	Client certificate	—	168
		Certificate	All Valid	167
		Certificate host	DoCoMo	169
	i-mode settings	Scroll	1 line	165
		Character size	Standard	111
		Set image display*	ON	165
		Set connection timeout	60 seconds	166
		Host selection (☰)81	i-mode	166

Main menu item	Sub-menu item	Lower sub-menu item	Setting at purchase	Reference		
i-mode	i-mode settings	 motion auto-play	ON	171		
		Use phone information	YES	165		
		Sound effect setting	ON	165		
		Doc. display settings	Fit page	327		
		Check settings	—	165		
		Reset last URL	—	154		
	Full Browser	Home		—	266	
		Bookmark	Not stored User created folder: None		156	
		Last URL	None		266	
		Go to location	No URL histories		155	
		Full Browser settings	Display Mode setting: PC mode			267
			Scroll			269
			Speed: High speed	Focus while scroll: OFF		
			Zoom: 100%			270
			Access setting: No			270
			Home URL: Home URL	http://www.google.co.jp		270
			Set image display: ON			270
			PC Movie auto-play: ON			270
			Cookie setting: Valid (No cookies)			271
			Referer setting: Send			271
		Script setting: Valid			270	
Window Open Guard: Invalid			270			
i-oppli	Software list(phone)	Pre-installed i-oppli programs only		221		
		Display: Icon display		222		
		 Auto start time: All unchecked		234		
		 Power saver: ON		224		
	 oppli(microSD)	SW list(microSD)		—	221	
		 oppli(microSD)		—	236	
	 oppli info	End stand-by info	No information		236	
		Security error history	No histories		223	
		Auto start info	No information		235	
		Trace info	No information		223	
	 oppli settings	Auto start setting	OFF		234	
		Disp. software info	Not display		221	
		Preferred tone	MUSIC		234	

Main menu item	Sub-menu item	Lower sub-menu item	Setting at purchase	Reference	
i-oppli	i-oppli settings	oBacklight	Depend on system	234	
		oPower saver	OFF	234	
		oVibrator	Depend on system	234	
		Check settings	—	234	
Settings	Sound	Select ring tone (menu)13	Phone: RING-Ta01 Videophone: RING-Ta02 Mail: SE-Ta02 Chat mail/MessageR/MessageF: SE-Ta03	92	
		Ring volume (menu)50	All Level 4	65	
		Keypad sound (menu)30	ON	94	
		Position to play (menu)64	Play all	93	
		Headset usage setting (menu)51	Headset+speaker	95	
		Mail/Msg. ring time (menu)68	All ON Ring time: All 5 seconds	95	
	Display	Display setting (menu)56	Stand-by display "TGB-flash03" for body color "RED" "TGB-flash02" for body color "CHAMPAGNE" "TGB-flash04" for body color "BLUE BLACK"	98	
			Clock Clock display: Big Day of week: Unavailable Position: Pattern 1 Color: White	112	
			Dialing, Incoming call, Videophone dialing, Videophone incoming, Mail sending, Mail receiving, Check new message, Mail/msg. rcpt result "RED" for body color "RED" "CHAMPAGNE" for body color "CHAMPAGNE" "BLUE BLACK" for body color "BLUE BLACK"	100	
			Icon color: Monochrome	100	
			Battery icon/Antenna icon: Pattern 1	100	
			Wake-up display: Wake up	99	
			Backlight (menu)70	Lighting: ON Power saver mode: ON Light time: 120 seconds	101
				Charging: Standard	101
				Area: LCD+Keys	101
				Brightness: Auto setting	101
		View blind	Soft light: ON	101	
			OFF Contrast: Level 1 (when "View blind" is set to "ON")	102	
		Color theme setting (menu)86	Black	102	

Main menu item	Sub-menu item	Lower sub-menu item	Setting at purchase	Reference		
Settings	Display	Menu icon setting (menu)57	"TGB-menu03" for body color "RED" "TGB-menu02" for body color "CHAMPAGNE" "TGB-menu04" for body color "BLUE BLACK"	103		
		Private menu setting (menu)52	Own number, Ring volume, Caller ID notification, Voice recorder, Alarm, Kisekae Tool, Vibrator, Full Browser, Character size, PC Movie, Schedule FUNC Change BG image: Normal	364		
		Desktop icon (menu)63	Guide (使いかたナビ)	365		
		Font (menu)66	Font 1	107		
		Character size	All Standard	110		
		Select language (menu)15	Japanese (日本語)	111		
		Recv.mail/call at open	OFF	43		
		Image quality	Dynamic	101		
		LCD AI	ON	102		
		Icons (menu)36		—		
		Icons (menu)36		—		
		Icons (menu)36		—		
		Icons (menu)36		—		
		Icons (menu)36		—		
	Illumination	All illum. setting		—	105	
		Illumination (menu)89	Set color: All Color 12		106	
			Set pattern: Standard		106	
			Color setting: All default		106	
		Illumination in talk	OFF		105	
		Miss/unread illum.	ON		105	
		Music&Video ch illum.	OFF		105	
		Illum. when folded	ON		105	
		Hourly illumination	OFF		105	
		MUSIC illumination	ON		105	
		IC card illumination	ON		105	
		Side key illumination	Pattern E-3		105	
	Kisekae	Check settings		—	105	
		Kisekae	Same as "Kisekae Tool" in "Data box"		430	
		Lock/Security	Self mode	Released		117
			Lock all	Released		116
			Personal data lock	Released		118
			IC card lock	Released		246
			Timer lock ON at close	All OFF		119
Secret mode (menu)40			Released		120	
Secret mode (menu)40			Released		120	







Main menu item	Sub-menu item	Lower sub-menu item	Setting at purchase	Reference		
Settings	Lock/Security	Secret data only (MENU)41	Released	120		
		Keypad dial lock	Released	119		
		Reject unknown	Accept	124		
		Call setting w/o ID (MENU)10	All Accept Select ring tone: All Same as ring tone	123		
		Change security code (MENU)29	0000	115		
		UIM setting	—	115		
		Scanning function	Set scan: All Valid	471		
		IC lock(power-off)	Setting before OFF	246		
		Call time/cost	Call data (MENU)61	Last call duration/Total calls duration: 0 seconds Calls reset/Cost reset: --/ --:--	Last call cost: ¥* * *	367
			Reset total cost&dura. (MENU)60	—	368	
	Notice call cost		OFF Max cost: ¥0 (when "Notice call cost" is set to "ON") Method to alert: Icon (when "Notice call cost" is set to "ON") Auto reset setting: OFF (when "Notice call cost" is set to "ON")	368		
	CLR max cost icon		—	368		
	Clock	Set time (MENU)31	Auto time adjust ON	44		
		World time watch	OFF	45		
		Summer time	OFF	45		
		Auto power ON/OFF	All OFF	356		
		Alarm setting	Alarm preferred	364		
		Incoming call	Vibrator (MENU)54	All OFF	93	
	Manner mode set (MENU)20		Manner mode When "Original" is set Record msg.: OFF      Vibrator: ON      Phone vol.: Silent Mail vol.: Silent      Alarm vol.: Silent      VM tone: ON Keypad sound: OFF      Mic sensitiv.: Up      LVA tone: OFF	97		
	Answer setting (MENU)58		Any key answer	63		
	Setting when opened		All Keep ringing	64		
	Record display set		All ON	120		
	Disp. PH-book image		ON	100		
	Disp. call/receive No.		Pattern 1	110		
	Ring time (MENU)90		Ring start time: OFF Start time: 1 second (when "Ring start time" is set to "ON")	124		
			Missed calls display: Display	124		
	Info notice setting (MENU)65		ON	106		

Main menu item	Sub-menu item	Lower sub-menu item	Setting at purchase	Reference	
Settings	Incoming call	V-phone while packet	V-phone priority	75	
		Auto answer setting (☎94)	OFF Ring time: 6 seconds (when "Auto answer setting" is set to "ON")	372	
	Talk	Volume	Level 4	64	
		Setting when folded (☎18)	End the call	64	
		Set hold tone	On hold tone: Tone 1      Holding tone: JESU JOY OF MAN'S DESIRING	66	
		Noise reduction (☎76)	ON	61	
		Quality alarm (☎75)	No tone	95	
		Reconnect signal (☎77)	No tone	60	
	Videophone	Visual preference	Normal	74	
		Select image	On hold: Pre-installed      Holding: Pre-installed Substitute image: Chara-den [男性 (Male)] Record message: Pre-installed      Preparing: Pre-installed Movie memo: Pre-installed	74	
		Hands-free w/ V. phone	ON	74	
		Voice call auto redial	OFF	75	
		Notify switchable mode	—	75	
		Reject videophone	OFF	125	
		Feel * Mail	Disp. /play new one	OFF	104
			Disp. /play in history	OFF	104
	Network setting	Prefix setting	WORLD CALL (009130010)	60	
		Int'l roaming	Network search mode: Auto	417	
			Operator name display: Display ON	418	
		Int'l dial assist	Auto assist setting: ON	59	
			Country Code set.: Japan (81) IDD prefix setting: WORLD CALL (009130010)	59 59	
	Status in the area	—	418		
	Melody Call setting		—	94	
	Other settings	Side keys guard	OFF	120	
		Character input method (☎35)	Input mode: All checked	376	
			Priority input method: Mode 1 (5-touch)		
			Predict: ON	378	
		Battery	Int.with secret: ON	378	
			Charge sound: ON	95	
		Pause dial (☎84)	Not stored	57	
	Sub-address setting	ON	60		
	Headset switch to call	OFF	372		

Main menu item	Sub-menu item	Lower sub-menu item	Setting at purchase	Reference
Settings	Other settings	Voice settings	Auto voice dial: OFF	89
			Voice earphone dial: OFF	89
			Read aloud settings: OFF	354
			Read aloud volume: Level 4	355
			Read aloud speed: Normal	355
			Read aloud output: Speaker	355
			Read aloud valid set.: Normal	355
		USB mode setting	Communication mode	313
		Reset settings (46)23)	—	373
		Initialize	—	373
Software update	Set auto-update: Auto-update Date: Default      Time: 3:00	466		
Data box	My picture (46)	Pre-installed data only	282	
		User created folder: None		
		Original animation: Not stored	289	
		<b>FUNC</b> Folder security: All released	316	
		<b>FUNC</b> Edit picture	288	
		Character stamp		
		Character color: 16 Color, Black      Font: Font 1      Character size: Standard size		
		<b>FUNC</b> Set display	283	
		Stand-by display		
		“TGB-flash03” for body color “RED”		
		“TGB-flash02” for body color “CHAMPAGNE”		
		“TGB-flash04” for body color “BLUE BLACK”		
		Wake-up display: Wake up		
		<b>FUNC</b> Positioning: Center	284	
		<b>FUNC</b> Sort: By date ↑	284	
		<b>FUNC</b> Picture/Title name: Picture	284	
		<b>FUNC</b> Display size: Normal	286	
MUSIC	No data	342		
	User created folder: None			
	Display: Title + Image	342		
	Volume: Level 12	343		
	<b>FUNC</b> Sound effect	347		
	Remaster: OFF      Listening: OFF      Equalizer: Normal			

Main menu item	Sub-menu item	Lower sub-menu item	Setting at purchase	Reference		
Data box	Music&Video Channel	No data		334		
		Information of previously played program: None		334		
		Display: Title + Image		334		
		Volume: Level 12		335		
		<b>FUNC</b> Play mode setting: Normal		336		
		<b>FUNC</b> Sound effect		337		
		Remaster: OFF	Listening: OFF	Equalizer: Normal		
		motion	Pre-installed data only			290
			User created folder: None			
			Playlist: Not stored			294
	Position memory: All not stored				291	
	Volume: Level 4				290	
	<b>FUNC</b> Folder security: All released				316	
	<b>FUNC</b> Set motion: All released				291	
	<b>FUNC</b> Sort: By date ↑				284	
	<b>FUNC</b> Listing: Title + Image				292	
	<b>FUNC</b> Sound effect				293	
	Remaster: OFF		Listening: OFF	Equalizer: Normal		
	<b>FUNC</b> Display size: Fit in display				293	
	<b>FUNC</b> Change to full: Vertical display playback				293	
	Melody (16)		Pre-installed data only			301
			User created folder: None			
			Playlist: Not stored			316
			<b>FUNC</b> Set as ring tone: All released			302
			<b>FUNC</b> Sort: By date ↑			303
	My documents	No data			323	
		<b>FUNC</b> Sort: By date ↑			284	
		<b>FUNC</b> Listing: Image			324	
	Kisekae Tool	Pre-installed data only			304	
		<b>FUNC</b> Sort: By date ↑			284	
		<b>FUNC</b> Listing: Image			304	
	Chara-den	Pre-installed data only			299	
		<b>FUNC</b> Substitute image: 男性 (Male)			71	
<b>FUNC</b> Rec. Chara-den				300		
Camera mode: Photo mode		Recording size: QCIF (176 x 144)				
Recording type: Video + voice		Recording quality: Normal				
<b>FUNC</b> Display size: Fit in display				300		

Main menu item	Sub-menu item	Lower sub-menu item	Setting at purchase	Reference	
Data box	PC Movie		Position memory: All not recorded	275	
			Played history: No histories	276	
			Volume: Level 12	274	
		FUNC	Listing: Title	276	
		FUNC	Sound effect Remaster: OFF      Listening: OFF      Equalizer: Normal	277	
		FUNC	Display size: Actual size	277	
		1Seg		Position memory: All not stored	297
				Volume: Level 12	298
			FUNC	Listing: Title + image	297
			FUNC	Icon: OFF	264
	FUNC		Image quality: Dynamic	263	
	FUNC		Sound Sound effect Auto volume: ON      Remaster: OFF Listening: OFF      Equalizer: Normal	263	
		FUNC	Caption: ON	298	
		Document viewer	—	327	
		SD other files	—	312	
	LifeKit	Bar code reader	Scan code	—	144
			Saved data	Not stored	145
Receive Ir data (max) 79)		Receive	—	319	
		Receive all	—	320	
SD-PIM		Phonebook	—	306	
		Schedule	—	306	
		Inbox	—	306	
		Outbox	—	306	
		Draft	—	306	
		Text memo	—	306	
		Bookmark	—	306	

Main menu item	Sub-menu item	Lower sub-menu item	Setting at purchase	Reference		
LifeKit	Camera	Photo mode/ Movie mode	<b>FUNC</b> Image size Photo mode: Stand-by (240 x 427)      Continuous mode: VGA (640 x 480) Movie mode: QVGA (320 x 240)	140		
			<b>FUNC</b> File size setting: Mail restrict'n (L)	140		
			<b>FUNC</b> Image quality: Fine	140		
			<b>FUNC</b> Camera settings Shutter sound: Sound 1      Flicker correction: Auto	140		
			<b>FUNC</b> Storage setting Store in: Phone      Auto save set: OFF      File restriction: File unrestricted	140		
			<b>FUNC</b> Img. stabilizer: Auto	141		
			<b>FUNC</b> Cont. shooting set. Continuous mode: Auto Shot interval: 0.5 second Shot number VGA (640 x 480)/CIF (352 x 288): 4 shots (Fixed) QVGA (240 x 320)/QCIF (176 x 144)/Sub-QCIF (128 x 96): 5 shots	141		
			<b>FUNC</b> Display size: Actual size	141		
			<b>FUNC</b> Icon: ON	141		
			<b>My picture</b>	Same as "My picture" in "Data box"	429	
			 motion	Same as "  motion" in "Data box"	430	
			Text reader	<b>Scan text</b>	—	146
				<b>Saved data</b>	Not stored	147
	<b>Rec. msg/voice memo</b> (  )55)	<b>Play/Erase msg.</b> <b>Play/Erase VP msg.</b> <b>Record message setting</b> OFF Answer message: Japanese 1 (when "Record message setting" is set to "ON") Ring time: 13 seconds (when "Record message setting" is set to "ON")		Not recorded Not recorded 68	70 70 68	
	Voice recorder	<b>Voice memo</b> <b>Voice announcement</b>	Not recorded Not recorded	366 94		
		<b>FUNC</b> File size setting: Mail restrict'n(L)	—	323		
		<b>FUNC</b> Storage setting Store in: Phone      Auto save set: OFF      File restriction: File unrestricted	—	323		
	Data Security Service	<b>Connect to Center</b> <b>Sent/recv. PB data list</b> <b>PB image sending</b>	— No histories OFF	90 90 90		
		Service (  )17)	<b>Activate</b>	—	45	
			<b>Check setting</b>	—	45	

Main menu item	Sub-menu item	Lower sub-menu item	Setting at purchase	Reference	
Service	Voice mail	Play messages	—	387	
		Activate	—	387	
		Deactivate	—	387	
		Set ring time	—	387	
		Check setting	—	387	
		Setting	—	387	
		Check new messages	—	386	
		Message notification	YES	—	387
		Erase icon	—	—	387
		Activate notice call	—	—	387
		Deactivate notice call	—	—	387
		Notice call status	—	—	387
		Call waiting	Activate	—	—
	Deactivate		—	—	388
	Check setting		—	—	388
	Call forwarding	Activate	—	—	390
		Deactivate	—	—	390
		Change forwarding No.	—	—	390
		Setting if fwd. No. busy	—	—	390
		Check setting	—	—	390
	Nuis. call blocking	Register caller	—	—	391
		Register selected No.	—	—	391
		Delete last entry	—	—	392
		Delete all entries	—	—	392
		Check No. of entries	—	—	392
	Caller ID request	Activate	—	—	392
		Deactivate	—	—	392
		Check setting	—	—	392

Main menu item	Sub-menu item	Lower sub-menu item	Setting at purchase	Reference
Service	2in1 setting		Deactivated Mode switching: Dual mode Stand-by display Dual mode: TGB-graphic02 B mode: TGB-graphic03 Set call/receive No. Disp. call/receive No.: Pattern 2 Ringtone set. for No. B Phone/Video-Phone: Pattern 4      Mail: Pattern 5 Receive avoidance set. Mode link: Deactivated	396
	Multi number	Set multi number	—	395
		Check setting	—	396
		Number setting	Not stored	395
		Set as ring tone	All Same as ring tone	396
	Arrival call act		Answer	394
	Set in-call arrival act	Activate	—	394
		Deactivate	—	394
		Check setting	—	394
	Remote control	Activate	—	395
		Deactivate	—	395
		Check setting	—	395
	Dual network	Dual network switching	—	392
		Check setting	—	392
	English guidance	Guidance setting	—	393
		Check setting	—	393
	Set Roaming guidance	Activate	—	418
		Deactivate	—	418
		Check setting	—	418
	Additional service	Additional service	Not stored	402
		Additional guidance	Not stored	403
	Service numbers	ドコモ故障問合せ (DOCOMO repair counter)	—	393
		ドコモ総合案内・受付 (DOCOMO Information Center)	—	393
OFFICEED	Area display setting	—	402	
	Activate forwarding	—	402	
	Deactivate forwarding	—	402	
	Check forwarding set.	—	402	



Main menu item	Sub-menu item	Lower sub-menu item	Setting at purchase	Reference
Service	Chaku-moji	Create message	Not stored	54
		Message disp. settings	Calls with callerID	56
		Sent messages	No records	55
		Prefer Chaku-moji	OFF	56
Phonebook	Add to phonebook	Phone	Not stored	78
		UIM	—	78
	Search phonebook	All?	—	83
		Reading?	—	83
		Group?	—	83
		Memory No.?	—	83
		Name?	<b>FUNC</b> Sort: Reading order	86
		Phone number?	<b>FUNC</b> Sort: Reading order	86
		Mail address?	<b>FUNC</b> Sort: Reading order	86
		2-touch dial?	—	84
	UIM operation	Copy	—	370
		Delete	—	370
	Dialed/recv. calls <small>(max)24</small>	Dialed calls	No records	52
			<b>FUNC</b> Sent address: No records	200
		Received calls	No records	53
			<b>FUNC</b> Received address: No records	200
	Own number <small>(max)0</small>	Not stored (except "Own number" for Number A)		365
	Group setting	<b>FUNC</b> Edit group Group name: Group 01 to 19 (except inside the UIM) Settings: None		83
	Restrictions	Restrict dialing	All released	123
		Call rejection	All released	123
		Call acceptance	All released	123
		Call forwarding	All released	123
		Voice mail	All released	123
	Phonebook settings <small>(max)26</small>	Character size	All Standard	111
		Voice dial setting	Not stored	88
		Mail group	Not stored	203
			<b>FUNC</b> Edit group name: Mail group 1 to 20	203
		Chat group	Not stored	213
			<b>FUNC</b> Edit group name: Group 1 to 5	214
	Forwarding image	ON	321	

Main menu item	Sub-menu item	Lower sub-menu item	Setting at purchase	Reference
Phonebook	No. of phonebook		—	86
Stationery	Alarm (☎44)		Not stored	356
			Alarm: All OFF	356
	Schedule (☎45)		Not stored	359
		FUNC	Monthly display/Weekly display: Monthly display	361
		FUNC	Customize holiday	361
			Sunday: Red      Monday to Friday: Default      Saturday: Blue	
	ToDo (☎95)		Not stored	363
		FUNC	Category display: All	363
		FUNC	Sort/Filter: By entered time	363
	Text memo (☎42)		Not recorded	369
	Calculator (☎85)			369
	Guide			36
Common phrase/dic. (☎38)	Common phrases	All default	381	
	Own dictionary	Not stored	382	
	Download dictionary	Pre-installed data only	383	
		FUNC Set dictionary: All valid	383	
MUSIC	MUSIC Player		No data	341
			Playlist: Not stored	348
			Information of previously played music file: None	340
			Display: Title + Image	341
			Volume: Level 12	343
		FUNC	Play mode setting: Normal	345
		FUNC	Sound effect	347
			Remaster: OFF      Listening: OFF      Equalizer: Normal	
			Same as "Music&Video Channel" in "Data box"	430
	1Seg	Activate 1Seg		Confirmation display at start*: Displays the Exemption Clause Confirmation display
			Confirmation display for the data broadcasting*: Displays the Exemption Clause Confirmation display	264
			Broadcasting storage area: Not stored	248
			Volume: Level 12	252
Program guide			—	255
Book program			Not stored	259
Timer recording			Not stored	260
		Confirmation display at timer recording: Displays the Exemption Clause Confirmation display	260	
Recording result		Not stored	262	
TVlink		Not stored	257	

Main menu item	Sub-menu item	Lower sub-menu item	Setting at purchase	Reference		
1Seg	Channel list		Not stored	250		
	Channel setting	Select area	—	250		
		Auto channel setting	—	250		
	User settings	Caption**	ON		263	
		Rec. when low battery**	ON		263	
		Image quality**	Dynamic		263	
		Sound**	Sound effect			263
			Auto volume: ON	Remaster: OFF		
			Listening: OFF	Equalizer: Normal		
		TV sound while closed: ON			263	
		ECO mode**	Released		263	
		Display light**	Constant light		264	
		Data broadcasting**	Set image display: ON			264
	Sound effect setting: ON				264	
Icon**	ON		264			
Check TV settings		—	264			
Reset channel setting		—	264			
Reset storage area		—	264			
Reset TV settings		—	264			
Osaifu-Keitai	IC card content		Pre-installed i-appli programs only	239		
	DCMX		—	233		
	ToruCa		No data		241	
		User created folder: None				
	IC card lock set.	IC card lock	Released		246	
		IC lock(power-off)	Setting before OFF		246	
	Settings	Receive ToruCa	Accept		246	
		Receiving display	ON		246	
		Check same data	ON		246	
		Auto reading	Accept		246	
	Search by i-mode		—	163		
Others	Redial		No records	52		
	Public Mode (Drive Mode)		Released	66		
	Manner mode		Released	96		
	Videophone		FUNC Backlight: Constant light	73		
	Photo-sending		FUNC Image size: QCIF (176 x 144)	140		

Main menu item	Sub-menu item	Lower sub-menu item	Setting at purchase	Reference
Others	Character input		<b>FUNC</b> Char. input/dict. Learned words: Not stored Candid. disp. size: Standard Candidate display: ON Character set time: OFF 2/NIKO-touch guide: ON	380

## List of Characters Assigned to Keys (5-touch Input Method)

Key	Display	abc	123	漢	か
①		. - @ _ / : ※2 □ ※1 1	1	あいうえおあいうえお	アイウエオアイウエオ
②		a b c A B C 2	2	かきくけこ	カキクケコ
③		d e f D E F 3	3	さしすせそ	サシスセソ
④		g h i G H I 4	4	たちつてとっ	タチツテトツ
⑤		j k l J K L 5	5	なにぬねの	ナニヌネノ
⑥		m n o M N O 6	6	はひふへほ	ハヒフヘホ
⑦		p q r s P Q R S 7	7	まみむめも	マミムメモ
⑧		t u v T U V 8	8	やゆやゆよ	ヤユヨヤユヨ
⑨		w x y z W X Y Z 9	9	らりるれろ	ラリルレロ
⑩		0 □ (space):	0	わをんわー □ (space)	ワヲン □ ※1ー □ (space)
✖		.ne.jp .co.jp .or.jp .com http://www. https://www. @docomo.ne.jp ※2	*	* * ※3	..
#		. ! ? ¥ & () * # " ' = ^ + ;	#	、。・！？	、。・！？

※1: Displayed when entering the character in full pitch.

※2: Displayed when entering the character in half pitch.

※3: Displayed when entering characters consecutively.

If you press (✖) after fixing a character, pictographs are displayed.

● If you press (↶) after entering a character, characters can be scrolled in the reverse order.

● After entering hiragana, katakana, or alphabetic characters, you can switch uppercase and lowercase characters by pressing (↷).

● You can enter "+" by pressing and holding (⑩) for at least one second in Numeral input mode.

# List of Characters Assigned to Keys (2-touch Input Method)

## Kanji/Hiragana input mode

<Uppercase input mode>

		Second digit									
		1	2	3	4	5	6	7	8	9	0
First digit	1	あ	い	う	え	お	A	B	C	D	E
	2	か	き	く	け	こ	F	G	H	I	J
	3	さ	し	ず	せ	そ	K	L	M	N	O
	4	た	ち	つ	て	と	P	Q	R	S	T
	5	な	に	ぬ	ね	の	U	V	W	X	Y
	6	は	ひ	ふ	へ	ほ	Z	?	!	-	/
	7	ま	み	む	め	も	¥	&			
	8	や	(	ゆ	)	よ	*	#		♥	
	9	ら	り	る	れ	ろ	1	2	3	4	5
	0	わ	を	ん	*	*	6	7	8	9	0

## Katakana input mode

<Uppercase input mode>

		Second digit									
		1	2	3	4	5	6	7	8	9	0
First digit	1	ア	イ	ウ	エ	オ	A	B	C	D	E
	2	カ	キ	ク	ケ	コ	F	G	H	I	J
	3	サ	シ	ス	セ	ソ	K	L	M	N	O
	4	タ	チ	ツ	テ	ト	P	Q	R	S	T
	5	ナ	ニ	ヌ	ネ	ノ	U	V	W	X	Y
	6	ハ	ヒ	フ	ヘ	ホ	Z	?	!	-	/
	7	マ	ミ	ム	メ	モ	¥	&			
	8	ヤ	(	ユ	)	ヨ	*	#		♥	
	9	ラ	リ	ル	レ	ロ	1	2	3	4	5
	0	ワ	ヲ	ン	*	*	6	7	8	9	0

## Alphabet input mode

		Second digit									
		1	2	3	4	5	6	7	8	9	0
First digit	1	"	\$	%	'	+	a	b	c	d	e
	2	,	.	:	:	<	f	g	h	i	j
	3	=	>	@	[	]	k	l	m	n	o
	4	^	_	*※1※2			p	q	r	s	t
	5	}	~※1~※2				u	v	w	x	y
	6						z	?	!	-	/
	7						¥	&			
	8		(		)		*	#			
	9						1	2	3	4	5
	0						6	7	8	9	0

☐ : Switches between uppercase input mode and lowercase input mode.

※1: Displayed when entering characters in full pitch.

※2: Displayed when entering characters in half pitch.

<Lowercase input mode>

		Second digit									
		1	2	3	4	5	6	7	8	9	0
First digit	1	あ	い	う	え	お	a	b	c	d	e
	2						f	g	h	i	j
	3						k	l	m	n	o
	4			つ			p	q	r	s	t
	5						u	v	w	x	y
	6						z				
	7										
	8	や		ゆ		よ					
	9										
	0	わ			,	.					

<Lowercase input mode>

		Second digit									
		1	2	3	4	5	6	7	8	9	0
First digit	1	ア	イ	ウ	エ	オ	a	b	c	d	e
	2						f	g	h	i	j
	3						k	l	m	n	o
	4			ッ			p	q	r	s	t
	5						u	v	w	x	y
	6						z				
	7										
	8	ヤ		ユ		ヨ					
	9										
	0	ワ※1			,	.					

## Information

- A space is entered if you press keys that correspond to a blank where no character is assigned.
- In Kanji/Hiragana or Katakana input mode, you can enter “ ” and “ ” also by pressing (X) just after entering a character. For “ ”, press (X) once. For “ ”, press (X) twice.
- You can enter “+” by pressing and holding (O) for at least one second in Numeral input mode.

# List of Characters Assigned to Keys (NIKO-touch Input Method)

## Kanji/Hiragana input mode

<Lowercase input>

		Second digit									
		1	2	3	4	5	6	7	8	9	0
First digit	1	あ	い	う	え	お	.	-	@	_	
	2	か	き	く	け	こ	a	b	c	2	
	3	さ	し	ず	せ	そ	d	e	f	3	
	4	た	ち	つ	て	と	g	h	i	4	
	5	な	に	ぬ	ね	の	j	k	l	5	
	6	は	ひ	ふ	へ	ほ	m	n	o	6	
	7	ま	み	む	め	も	p	q	r	s	7
	8	や	ゆ	よ	ゃ	ゅ	ょ	t	u	v	8
	9	ら	り	る	れ	ろ	w	x	y	z	9
	0	わ	を	ん	.	。	-	.	!	?	0

## Katakana input mode

<Lowercase input>

		Second digit									
		1	2	3	4	5	6	7	8	9	0
First digit	1	ア	イ	ウ	エ	オ	.	-	@	_	
	2	カ	キ	ク	ケ	コ	a	b	c	2	
	3	サ	シ	ス	セ	ソ	d	e	f	3	
	4	タ	チ	ツ	テ	ト	g	h	i	4	
	5	ナ	ニ	ヌ	ネ	ノ	j	k	l	5	
	6	ハ	ヒ	フ	ヘ	ホ	m	n	o	6	
	7	マ	ミ	ム	メ	モ	p	q	r	s	7
	8	ヤ	ユ	ヨ	ャ	ュ	ョ	t	u	v	8
	9	ラ	リ	ル	レ	ロ	w	x	y	z	9
	0	ワ	ヲ	ン	.	。	-	.	!	?	0

## Information

- A space is entered if you press keys that correspond to a blank where no character is assigned.
- You can enter “ ” and “ ” by pressing (✕). For “ ”, press (✕) once. For “ ”, press (✕) twice. In Kanji/Hiragana input mode, you can enter them by pressing the key just after entering a character.
- You can enter “+” by pressing and holding (○) for at least one second in Numeral input mode.

<Uppercase input>

		Second digit									
		1	2	3	4	5	6	7	8	9	0
First digit	1	あ	い	う	え	お					
	2	カ			ケ			A	B	C	
	3							D	E	F	
	4			つ			つ	G	H	I	
	5							J	K	L	
	6							M	N	O	
	7							P	Q	R	S
	8	ゃ	ゅ	ょ	ゃ	ゅ	ょ	T	U	V	
	9						W	X	Y	Z	
	0	わ									

<Uppercase input>

		Second digit									
		1	2	3	4	5	6	7	8	9	0
First digit	1	ア	イ	ウ	エ	オ					
	2							A	B	C	
	3							D	E	F	
	4			ッ			ッ	G	H	I	
	5							J	K	L	
	6							M	N	O	
	7							P	Q	R	S
	8	ャ	ュ	ョ	ャ	ュ	ョ	T	U	V	
	9						W	X	Y	Z	
	0										







Symbol	Voice guidance
ㇿ	ワット
ㇾ	カロリー
ㇽ	ドル
ㇼ	セント
ㇻ	パーセント
ㇺ	ミリバール
ㇻ	ページ
mm	ミリメートル
cm	センチメートル

Symbol	Voice guidance
km	キロメートル
mg	ミリグラム
kg	キログラム
cc	シーシー
m	ヘーホーメートル
〒	ヘーセー
*	—
.	—
No	ナンバー

Symbol	Voice guidance
KK	ケーケー
TEL	デンワ
㊦	マルウエ
㊧	マルナカ
㊨	マルシタ
㊩	マルヒダリ
㊪	マルミギ
㊫	カッコカブ
㊬	カッコユー

Symbol	Voice guidance
(代)	カッコダイ
☎	メッセージ
㊭	タイショー
㊮	ショーワ
≡	ニアリーイコール
≡	ゴードー
∫	インテグラル
♣	ファイ
Σ	シグマ

Symbol	Voice guidance
√	ルート
⊥	スイチョク
∠	カク
∟	チョッカク
∠	サンカクケー
∴	ナゼナラバ
∩	キョーツー
U	ガッペー

※1 Does not read aloud if it is not for a URL or mail address.

※2 When it follows a hiragana, katakana, or kanji character, the ending of the character immediately before it is read aloud as a long vowel.

※3 When it follows a hiragana or katakana character, the ending of the character immediately before it is read aloud as a long vowel.

※4 Reads it aloud "ハイフン (hyphen)" if it is for a URL or mail address.

### Information

- Special symbols "㊠" through "U" might not be correctly displayed if they are sent to mobile phones which do not support i-mode or personal computers. Further, you cannot enter special symbols of into the text of SMS messages, and they are replaced by half-pitch spaces.

## Symbol Candidate List

On the Character Entry (Edit) display, enter "きごう" to convert it to bring up symbol candidates. Further, you can enter characters listed below to convert them into respective symbols.

Input	Conversion
おなじ	〃 々
から	～
かんま	.
こんま	.
たてせん	
てんでん	… …
りーだ	…
しめ	♣
かっこ	" " ( ) ◊ ◊ ◊ ◊ ◊ ◊ ◊ [] [] []
たす	+
ひく	-

Input	Conversion
ぶらすまいなす	±
かける	×
わる	÷
いこーる	=
ぶとうごう	<> ≤ ≥
しょうなり	<
だいなり	>
しょうなり	∞
いこーる	∞
だいなり	∞
いこーる	∞
おげんだい	∞
おす	♣

Input	Conversion
めす	♀
ならば	⇒
どうち	⇔
にありいこーる	≡
ちいさい	≪
おおきい	≫
るーと	√
ど	° C
ぶん	'
びょう	'
どる	\$
せんと	¢
ほんど	£

Input	Conversion
せつ	§
ほし	* ☆ ★
あっと	@
まる	。 ○ ● ◎ ○
しかく	◇ ◆ □ ■
さんかく	△ ▲ ▼ ▽
こめ	*
ゆうびん	〒
やじるし	↔ ↕ ↘
うえ	↑
した	↓
みぎ	→

Input	Conversion
ひだり	←
あすたりすく	*
おんぐすと	Å
ろーむ	Å
しゃーぷ	#
ぶらっと	b
おんぷ	♪
だがー	†
だぶるだがー	‡
だんらく	¶
おーむ	Ω
でんわ	TEL

# Pictograph List

When “Read aloud settings” is set to “ON”, pictographs are read aloud.

Pictograph	Voice guidance
	ハートマーク
	ユレルハートマーク
	シッレンマーク
	フクスーハートマーク
	ワイマーク
	ブンブンマーク
	ガクマーク
	モウヤダーマーク
	フラフラマーク
	ルンルンマーク
	オンセンマーク
	カワイイマーク
	チュウマーク
	ピカピカマーク
	ヒラメキマーク
	ムカッマーク
	パンチマーク
	バクダンマーク
	ムードマーク
	ネムイマーク
	ビックリマーク
	ビックリハテナマーク
	ニジュービックリマーク
	ドーンマーク
	アセアセマーク
	アセタラーマーク

Pictograph	Voice guidance
	ダッシュマーク
	ウーマーク
	ウンマーク
	グッドマーク
	パッドマーク
	ミギナナメウエヤジリシマーク
	ミギナナメシタヤジリシマーク
	ヒダリナナメウエヤジリシマーク
	ヒダリナナメシタヤジリシマーク
	ハレマーク
	クモリマーク
	アメマーク
	ユキマーク
	カミナリマーク
	タイフマーク
	キリマーク
	コサメマーク
	オヒツシザマーク
	オウシザマーク
	フタゴザマーク
	カニザマーク
	シシザマーク
	オトメザマーク
	テンビンザマーク

Pictograph	Voice guidance
	サソリザマーク
	イテザマーク
	ヤギザマーク
	ミズガメザマーク
	ウオザマーク
	スポーツマーク
	ヤキューマーク
	ゴルフマーク
	テニスマーク
	サッカーマーク
	スキーマーク
	バスケットマーク
	モータースポーツマーク
	ページャマーク
	デンジャマーク
	チカテツマーク
	シンカンセンマーク
	セダンマーク
	アルプイマーク
	バスマーク
	フネマーク
	ヒコーキマーク
	イエマーク
	ビルマーク
	ユーピンキョクマーク
	ビョーインマーク

Pictograph	Voice guidance
	ギンコーマーク
	エーティーエムマーク
	ホテルマーク
	コンビニマーク
	ガソリンスタンドマーク
	チューシャジョーマーク
	シンゴマーク
	トイレマーク
	レストランマーク
	キッサテンマーク
	バーマーク
	ビールマーク
	ファーストフードマーク
	プティックマーク
	ビョーインマーク
	カラオケマーク
	エーガマーク
	ユーエンチマーク
	オンガクマーク
	アートマーク
	エンゲキマーク
	イベントマーク
	チケットマーク
	キツエンマーク

Pictograph	Voice guidance
	キンエンマーク
	カメラマーク
	カバンマーク
	ホンマーク
	リボンマーク
	プレゼントマーク
	パスデマーク
	デンワマーク
	ケータイデンワマーク
	メモマーク
	テレビマーク
	ゲームマーク
	シーディーマーク
	ハートマーク
	スペードマーク
	ダイヤマーク
	クラブマーク
	メマーク
	ミミマーク
	グーマーク
	チョキマーク
	パーマーク
	アシマーク
	クツマーク
	メガネマーク
	クルマイスマーク

Pictograph	Voice guidance
	シンゲツマーク
	カケツキマーク
	ハンゲツマーク
	ミカツキマーク
	マンゲツマーク
	イヌマーク
	ネコマーク
	リゾートマーク
	クリスマスマーク
	カチンコマーク
	フクロマーク
	ペンマーク
	ヒトカゲマーク
	イスマーク
	ヨルマーク
	スーンマーク
	オンマーク
	エンドマーク
	トケーマーク
	デンワヘマーク
	メールヘマーク
	ファックスヘマーク
	アイモードマーク
	アイモードマーク
	メールマーク
	ドコモテークョーマーク

Pictograph	Voice guidance
	ドコモポイント マーク
	ユーリョーマーク
	ムリョーマーク
	アイディーマーク
	パスワードマーク
	ツギアリマーク
	クリアマーク
	サーチマーク
	ニューマーク
	イチジョーホー マーク
	フリーダイヤル マーク
	シャープダイヤル マーク
	モバキューマーク
	シカクイチ
	シカクニ
	シカクサン
	シカクヨン
	シカクゴ
	シカクロク
	シカクナナ
	シカクハチ
	シカクキュー
	シカクゼロ

Pictograph	Voice guidance
	ケッテーマーク
	アイアプリマーク
	アイアプリマーク
	ティーシャツマーク
	ガムガチサイフマーク
	ケショーマーク
	ジーンズマーク
	スノボマーク
	チャペルマーク
	ドアマーク
	ドルブルクロマーク
	パソコンマーク
	ラブレターマーク
	ランチマーク
	エンピツマーク
	オーカンマーク
	ユビワマーク
	スナドケーマーク
	ジテンシャマーク
	ユノミマーク
	ウデドケーマーク
	ムムマーク
	ホツマーク
	ヒヤアセマーク
	ヒヤアセマーク
	ブクマーク

Pictograph	Voice guidance
	ポケッマーク
	ラブラブマーク
	オーケーマーク
	アッカンベーマーク
	ウィンクマーク
	ウレシイマーク
	ガマンマーク
	ネコマーク
	ナキマーク
	ナミダマーク
	エヌジーマーク
	クリップマーク
	コピーライトマーク
	トレードマーク
	ハシルヒトマーク
	マルヒマーク
	リサイクルマーク
	レジストレッドマーク
	キケンマーク
	キンシマーク
	クーシツマーク
	ゴーククマーク
	マンシツマーク
	サユーマーク
	ジョーゲマーク
	ガッコーマーク

Pictograph	Voice guidance
	ナミマーク
	フジサンマーク
	クローバーマーク
	サクランボマーク
	チューリップマーク
	バナナマーク
	リンゴマーク
	ワカバマーク
	モミジマーク
	サクラマーク
	オニギリマーク
	ショートケーキ マーク
	トックリマーク
	どんぶりマーク
	パンマーク
	カタツムリマーク
	ヒヨコマーク
	ペンギンマーク
	サカナマーク
	ウマイマーク
	ウッシッシマーク
	ウママーク
	ブタマーク
	ウィングラスマーク
	ゲッソリマーク

### Information

- Pictographs are all counted as full-pitch characters.
- Pictographs are not correctly displayed if they are sent to mobile phones which do not support i-mode or to personal computers. Further, the pictographs from “” through “” are correctly displayed only when sent to i-mode phones which support those pictographs.

## Common Phrase List

No.	Expressions
<b>"Greetings" folder</b>	
1	Good morning
2	Good afternoon
3	Good evening
4	Good night
5	I'm going
6	Have a nice day
7	I'm back
8	Welcome back
9	I'm sorry
10	Good-bye
<b>"Business" folder</b>	
1	Your cooperation is greatly appreciated
2	We always appreciate your business
3	Please send my best regards to everyone
4	Thank you very much for the other day
5	How's everything?
6	I will be late
7	See you later
8	All right
9	Check urgently!
10	Call me

No.	Expressions
<b>"Internet" folder</b>	
1	@docomo.ne.jp
2	.ne.jp/
3	.co.jp/
4	.or.jp/
5	.ac.jp/
6	.com/
7	http://www.
8	https://www.
9	www.
10	.html
<b>"Smiley 1" folder</b>	
1	(*_O_)/
2	♪(∇∇)/"
3	(´Д`)ノ~~~~
4	<( _ _ ; )>
5	(^-人^-)
6	O(≥∇≤)O
7	( p_q)I-ン
8	( τ_τ)
9	Σ(∩◇*)IEツ
10	(*≥m≤*)フブツ
<b>"Smiley 2" folder</b>	
1	(「´0`」)オーイ
2	ツンツン(。° -°)σ
3	∨(・ε・)オイオイ
4	(・o・)♪了解!
5	(; _ _) アヤシイ
6	∨(≥∇≤) // ヤダヤダ
7	σ(∇∇)
8	<( ^ ^ )> Eヘン
9	∩( _ _ ) ∩ フツ
10	~~~~-(・▽・)- ブーン

## Multiaccess Combination Patterns

Communication event Communication status	Voice call		Videophone call		i-mode	i-mode mail		SMS		i- <b>appli</b>	i- <b>appli</b> software running	Packet communication (Data communication)		64K data communication	
	Outgoing	Incoming	Outgoing	Incoming	Connecting	Sending	Receiving	Sending	Receiving	Outgoing	Outgoing	Sending	Receiving	Sending	Receiving
Voice call	△※1	△※2	—	—※3	○	○	△※5	○	△※5	—	—	○	△※5	—	—※3
Videophone call	—	—※3	—	—※3	—	—	—	—	△※5	—	—	—	—	—	—※3
i-mode	○	○	△※6	△※7	—	○	○	○	○	—	—	—	—	—	—
i-mode mail	○	○	△※6	△※7	○	—	—	—	△※5※8	—	—	—	—	—	—
SMS	○	○	○	○	○	—	△※5※8	—	△※5	○	○	○	△※5	○	△※5
i- <b>appli</b> ※9	—	○	—	△※7	—	—	△※5	—	△※5	—	—	—	—	—	—
i- <b>appli</b> software running	○	○	△※6	△※7	—	○	△※5	○	△※5	—	—	—	—	—	—
Packet communication (Data communication)	○	○	—	—※4	—	—	—	○	○	—	—	—	—※3	—	—
64K data communication	—	—※3	—	—※3	—	—	—	—	○	—	—	—	—	—	—※3

○: Can start.

△: Can start by condition.

—: Cannot start simultaneously. The current communication continues (the started communication is rejected).

※1: If you have signed up for "Call waiting", you can make another call with the current voice call put on hold.

※2: In the condition of the maximum number of voice line+1, you can activate Voice Mail, Call Waiting, or Call Forwarding. (See page 386, page 388, and page 390)

※3: If you have signed up for "Call waiting", "Voice mail", or "Call forwarding", you can answer an incoming call after finishing a call or communication. (See page 394)

※4: The call is recorded as a missed call in Received Calls.

※5: "☐(white)" appears to notify of incoming mail.

※6: i-mode communication is cut off, and you can make a call.

※7: The FOMA phone works in accordance with the setting of "V-phone while packet".

※8: For i-mode mail and SMS, you can use a single line each at a time.

※9: This is the case for when you are upgrading or downloading an i-**appli** program.

## Multitask Combination Patterns

When the functions in the same group (  part in the table) conflict, the display for switching active functions appears. However, it might not appear depending on the operation.

Function in operation \ Started function	Voice call	Video phone call	Mail	i-mode group		Setting group		Tool group						Private menu ※2	
				i-mode ※1	i-oppli	Settings ※2	Service	Data box ※1	LifeKit※3	Phone book ※4	Stationery	MUSIC ※5	1Seg※5		Osaifu-Keitai ※5
Voice call	—	—	○	○	—	○	○※6	—	○※7	○	○※8	—	—	○	○
Videophone call	—	—	—	—	—	—	—	—	—	—	—	—	—	—	—
Mail	○	○	—	○	○	○	○	○	○	○	○	○	○	○	○
i-mode※1	○	○	○	—	—	○	○	○	○	○	○	○	○	○	○
i-oppli	○	○	○	—	—	○	○	○	○	○	○	○※9	○	○	○
Settings※2	○	○	○	○	○	—	—	○	○	○	○	○	○	○	○
Service	○	○	○	○	○	—	—	○	○	○	○	○	○	○	○
Data box※1※10	○	○	○	○	○	○	○	—	—	—	—	—	—	—	○
LifeKit※3	○※11	○※11	○※12	○	○	○	○	○	—	—	—	—	—	—	○
Phonebook※4	○	○	○	○	○	○	○	○	—	—	—	—	—	—	○
Stationery	○	○	○	○	○	○	○	—	—	—	—	○※14	—	—	○
MUSIC※5	○※15	○※15	○※16	○	○※9	○	○※17	○※15※18	—※13	○	○※14	—	—	○	○
1Seg※5	○※15	○※15	○※16	○	○※15	○	○	—	—	—	—	—	—	—	○
Osaifu-Keitai※5	○	○	○	○	○	○	○	—	—	—	—	—	—	—	○

○: Can be activated simultaneously. —: Cannot be activated simultaneously.

※1: While a PDF file is displayed, the i-mode group is in use. However, 1Seg programs or "1Seg" in Data Box cannot be activated simultaneously.

※2: You cannot use it depending on the function.

※3: You cannot use Multitask to start up "Receive Ir data" and "SD-PIM".

※4: You cannot use Multitask to start up "UIM operation". You cannot start up "Restrictions" while another function is in use, either.

※5: The functions not belonging to the Tool group are included.

※6: You cannot start up "Caller ID notification" and "2in1 setting" during a call.

※7: LifeKit functions you can start up during a call are limited to "Bar code reader", still image shooting of "Camera", "Text reader", and "Data Security Service".

※8: Stationery functions you can start up during a call are limited to "Schedule", "ToDo", "Text memo", "Calculator", and "使いかたナビ (Guide)".

※9: For some i-oppli programs, MUSIC cannot be simultaneously activated, and Play Background is not available.

※10: If you use Multitask to switch functions while you are using the Picture viewer (microSD card), i-motion player, Video player, Chara-den player, or Melody player, or while playing back a demo from "MUSIC" in Data Box, display or playback ends. You cannot switch functions while you are editing an i-motion movie.

- ※11: Playback/Recording stops when a call comes in while you are playing back "Record message", "Videophone record message", "Voice memo", or "Movie memo", or while recording "Voice memo". When a call comes in while you are scanning data using "Bar code reader" or "Text reader", the data being scanned is discarded.
- ※12: If you set "Receiving display" to "Alarm preferred" and a mail message comes in while you are scanning data using "Bar code reader" or "Text reader", the data being scanned is discarded.
- ※13: You can simultaneously start it with "Bar code reader", "Camera", "Text reader", or "Voice recorder". However, Play Background is not available.
- ※14: You cannot simultaneously start MUSIC with "使いかたナビ (Guide)".
- ※15: Play Background is not available.
- ※16: If you set "Receiving display" to "Alarm preferred" and a mail message comes in, the playback is suspended.
- ※17: You cannot use "2in1 setting" and "Chaku-moji".
- ※18: You cannot simultaneously start "MUSIC Player", "MUSIC", "Music&Video Channel", and "PC Movie".



## Services Available with FOMA Phones

Available services	Phone number
Directory assistance service (Charges apply: guidance fee + call fee) ※ Listed phone numbers only can be given.	(No prefix) 104
Telegrams (Telegram charges apply)	(No prefix) 115
Time check (Charges apply)	(No prefix) 117
Weather forecast (Charges apply)	City code of the desired area + 177
Emergency calls to police	(No prefix) 110
Emergency calls to fire station and ambulance	(No prefix) 119
Emergency calls for accidents at sea	(No prefix) 118
Disaster messaging service (Charges apply)	(No prefix) 171
Collect calls (Charges apply: guidance fee + call fee)	(No prefix) 106

### Information

- When using the collect call (106), the recipient is charged a call fee and handling fee ¥90 (¥94.5 with tax) for each call. (As of June 2008)
- When using the directory assistance service (104), you are charged a guidance fee ¥100 (¥105 with tax) plus a call fee. For whom having weak eyesight or handicapped arms, the guidance is available charge free. For more details, dial 116 (NTT inquiry counter) from landline phones. (As of June 2008)
- This FOMA phone supports "Emergency Location Report".  
When you make an emergency call such as at 110/118/119, information about the place where you are dialing from (location information) is automatically notified to emergency-response agencies such as police stations. It might happen that your correct location is not detected by emergency-response agencies depending on the location you dialed or radio wave conditions.  
When you do not notify your phone number by call such as by adding "184", your location information and phone number are not notified. However, when an emergency-response agency has judged that the location information and phone number should be detected because of emergency priority such as protection of human life, they might be notified regardless of your setting.  
The region and timing "Emergency Location Report" is introduced vary depending on the preparation of respective emergency-response agencies.

### Information

- When you make a call at 110/119/118 from the FOMA phone, tell an operator that you are calling from a mobile phone and then precisely notify your phone number and actual location. Further, remain still while talking to prevent your call from being disconnected. Do not turn off the power immediately after the call, but instead make sure that your phone can receive calls for at least 10 minutes.
- You might not be connected to regional police/fire station depending on the area from where you call. If this happens, use public phones nearby or landline phones.
- If you use "Call Forwarding Service" for the landline phone and specify a mobile phone as the forwarding destination, callers may hear ringing tone even when the mobile phone is busy, out of the service area, or the power is turned off depending on the settings of the landline phone/mobile phone.
- Note that the FOMA phone is not available to 116 (NTT inquiry counter), Dial Q2, Message Dial, and credit call services. (You can use auto credit call to the FOMA phone from landline phones or public phones.)

## Introduction of Options and Related Equipment

Combining various options with the FOMA phone, you can realize more versatile use from personal purpose to business purposes. Some products may not be dealt in depending on the area. For details, consult a handling counter such as a DOCOMO shop. For details on options, refer to the user's manuals of respective options and related equipment.

- Battery Pack P17
- Back Cover P28
- FOMA AC Adapter 01/02※1
- FOMA AC Adapter 01 for Global use※1
- FOMA DC Adapter 01/02
- FOMA Portable Charging Adapter 01
- FOMA Dry Battery Adapter 01
- Desktop Holder P26
- FOMA USB Cable with Charge Function 01/02※2
- FOMA USB Cable※2
- FOMA Indoor Booster Antenna※3
- FOMA Indoor Booster Antenna (Stand Type)※3
- Carry Case S 01
- In-Car Holder 01
- Earphone/Microphone with Switch P001/P002※4※5
- Earphone Plug Adapter P001※5
- Flat-plug Earphone/Microphone with Switch P01/P02※5
- Flat-plug Stereo Earphone Set P01※5
- Bone conduction microphone/receiver※5
- Earphone Plug Adapter for External connector terminal 01
- In-Car Hands-Free Kit 01※6
- FOMA In-Car Hands-Free Cable 01

※1 See page 40 and page 41 for charging batteries using AC adapter.

※2 If you use a USB hub, the devices may not work correctly.

※3 Use it in Japan only.

※4 Earphone Plug Adapter P001 is required.

※5 Earphone Plug Adapter for External connector terminal 01 is required.

※6 To use/charge the FOMA phone via cable connection (USB connection), FOMA In-Car Hands-Free Cable 01 is required.

## Introduction of Software for Playing Back Moving Images

To play back moving images (MP4 format file) using your personal computer, you need to have QuickTimePlayer (free) ver. 6.4 or higher (or ver. 6.3 + 3GPP) of Apple Computer Inc.

You can download QuickTime from the following web page:  
<http://www.apple.com/jp/quicktime/download/> (Japanese only)

### Information

- For download, a personal computer connected to the Internet is required. You are charged a communication fee to download.
- For details such as operating environments, how to download, and how to operate, refer to the web page above.

## Links with AV Equipment

On the FOMA phone, you may be able to play back some moving images in ASF format, which are saved from another AV equipment to the microSD card. Also, you may be able to play back some moving images recorded with the FOMA phone on another AV equipment. For information about links with compatible AV equipment, refer to the following:

<http://panasonic.jp/mobile/> (Japanese only)

## Inquiry Center for Links with Compatible AV Equipment

### ■ Panasonic Mobile Communications Customer Service Center

From landline phones: ☎ 0120-15-8729

From mobile phones or PHSs: 045-938-4023



Business hours: 9:00 a.m. to 5:00 p.m.

(Excluding Saturdays, Sundays, national holidays, and specified holidays)

- Make sure that you dial the correct number.

## Troubleshooting

• First of all, check to see if you need to update the software program and then update it if required. See page 465 for how to update software programs.

Problem	Check point	Reference
The FOMA phone does not turn on. (Cannot use)	• Make sure the battery is attached to the FOMA phone correctly.	39
	• Make sure the battery is fully charged.	40
	• If the mova is usable in Dual Network Service, the FOMA phone service is not available. Is the FOMA phone usable? For details, refer to "Mobile Phone User's Guide [Network Services]".	392
Cannot dial by pressing numeric keys.	• Make sure Keypad Dial Lock is deactivated.	119
	• Make sure Restrict Dialing is deactivated.	122
	• Make sure Lock All is deactivated.	116
	• Make sure Self Mode is deactivated.	117
Dialing fails and cannot get through to; a busy tone sounds.	• Enter the phone number after you listen for the dial tone.	—
Dialing fails and cannot get through to; the guidance requires to check the dialing procedure.	• Make sure the phone number contains a city code.	48
"  " appears and cannot make calls.	• You may be out of the service area or weak radio waves are being received.	43
"  " and "Lock all" are displayed and pressing keys are null.	• This may be because Lock All is activated.	116
Pressing the side keys does not work when the FOMA phone is closed.	• This may be because "Side keys guard" is set to "ON".	120
Alert beeps.	• The battery runs short. You need to charge.	40

Problem	Check point	Reference
Cannot charge. (The Call/Charging indicator of the FOMA phone does not light, or it flickers.)	• Make sure the battery is attached to the FOMA phone correctly.	39
	• Make sure the power plug of the adapter is securely inserted into outlet. • Make sure the adapter and the FOMA phone is firmly connected. For AC adapter (option), make sure its connector is firmly connected to the FOMA phone or a desktop holder (option).	41
The display grows dark, showing nothing.	• Make sure Power Saver Mode is deactivated.	101
Different ring tones sound for incoming mail.	• This may be the mail from a party whose mail ring tone is set by the setting items in the Phonebook.	81
	• This may be the mail from a party stored in a group set with a mail ring tone by Group Setting.	83
When a call or mail message comes in, the Call/Charging indicator lights/flickers differently.	• This may be the call or mail message from a party for whom you have set "Illumination/Mail illumination" by setting items in the Phonebook.	81
	• This may be the call or mail message from a party stored in a group set with "Illumination/Mail illumination" by Group Setting.	83
Images or melodies selected in the functions are not played back; they are played back at the default setting.	• Make sure the UIM that was inserted when you obtained images or melodies is inserted.	37
Cannot watch a 1Seg program.	• You may be out of the terrestrial digital TV broadcasting service area or weak airwaves are being received.	248
	• Make sure the UIM is inserted.	37
	• Make sure Channel Setting is set.	249
Cannot perform data transfer	• Make sure that you do not use a USB hub. If you use a USB hub, the devices may not work correctly.	—

## Error Messages

- “(numerals)” in error messages are the code sent from the i-mode Center for discriminating the error.

### A

#### ACMmax regulation

##### Cannot dial

- …Total Calls has exceeded the maximum cost. Execute “Reset total cost”. (See page 368)

##### Activating

- …Receive Option Setting is set to “OFF”. Switch the setting to “ON” and try again. (See page 186)

##### Activating keypad dial lock

- …Keypad Dial Lock is activated. Release Keypad Dial Lock and try again. (See page 119)

##### Activating mail security

##### Cannot download

- …Mail Security is activated, so you cannot download. Deactivate Mail Security and try again. (See page 121, page 195)

##### Activating personal data lock

- …Personal Data Lock is set. Release Personal Data Lock and try again. (See page 118)

##### Activating personal data lock

##### Send pre-installed substitute image

- …During Personal Data Lock, a “Pre-installed” substitute image is sent.

##### Activating record display OFF

- …Record Display Set is set to “OFF”. Switch the setting to “ON” and try again. (See page 120)

##### Activating reject unknown

- …“Reject unknown” is set to “Reject”. Set to “Accept” and try again. (See page 124)

##### Activating ring time

- …“Ring time” is set to “ON”. Set to “OFF” and try again. (See page 124)

##### Address is not valid (451)

- …You could not send the mail correctly. Check the address and try again. (See page 174, page 214)

##### All protected

##### Cannot delete

- …All data items are protected, so cannot be deleted. Release the protection and try again. (See page 159, page 196, page 207)

##### Another function is active

##### Cannot connect

##### Another function is active

##### Cannot operate

##### Another function is active

##### Cannot switch

- …The function is not available simultaneously in Multitask. End the functions not in use and try again. (See page 354)

##### Authentication failed

- …An authentication error occurred.

##### Authentication type is not supported (401)

- …Incompatible authentication type, so cannot be connected.

##### Auto time adjust info is not received

##### Unable to play

- …You have not received the auto time adjust information, so could not play back the file with restrictions on the playable period or playable deadline.

### C

##### Cannot compose because too large data

- …The size of the shot image is too large to attach to i-mode mail.

##### Cannot dial

- …An error occurred, so you could not dial.

##### Cannot display

- …Corresponding software program is running. End the software program and try again. (See page 222)

##### Cannot edit message

- …The attached file reaches 10,000 bytes, so you cannot enter the text.

##### Cannot execute because of other tasks

- …The function is not available simultaneously in Multitask. End the functions not in use and try again. (See page 354)

##### Cannot recognize

- …The text could not be scanned. Change Recognition Mode or NEGA/POSI Mode, and scan the text again. (See page 148)

##### Cannot record

- …An error occurred, so you could not save.

##### Cannot resend

##### Send after edit

- …The address is invalid or the text exceeds the size that can be entered, so you cannot re-send. Edit the text again and send. (See page 196)

##### Cannot save

- …The data could not be obtained from a site, so could not be saved.

##### Cannot save some attached files

- …Full of images, so part of the images could not be stored into the Phonebook.

##### Cannot set this holiday

- …The received holiday and already stored data are set to the same date, so you cannot store it.

##### Cannot set this schedule

- …The received schedule event and already stored data are set to the same date and time, so you cannot store it.

##### Cannot start any more functions

- …The maximum number of functions is already running using Multitask. End the functions not in use and try again. (See page 354)

##### Cannot start because use mail folder

- …Corresponding software program is running. End the software program and try again. (See page 222)

---

**Cannot use network transmission**

...“Network set” is set to “OFF”. Set it to “ON” and try again. (See page 223)

---

**Certificate is rejected****Certificate is rejected (tampered)**

...You received an altered SSL/TLS certificate, so could not connect.

---

**Check new message is set all OFF**

...No check marks are placed to the items for “Set check new message”. Put a check mark for the items to be checked and try again. (See page 204)

---

**Check SMS center selection**

...The SMS Center is not correctly specified by SMS Center Selection. Specify the SMS Center and try again. (See page 217)

---

**Conditional access****Cannot watch**

...Receiving by limited method, so you cannot watch.

---

**Connection failed**

...Radio waves are weak, so you cannot connect. Move to a place where radio waves are strong enough and try again.

...The destination address set by Host Selection is wrong, so you cannot connect to it. Check the setting and try again. (See page 166)

...You could not connect because of network trouble. Wait a while and try again.

---

**Connection failed (403)**

...You cannot connect to a site or Internet web page.

---

**Connection failed (562)**

...You could not connect because of network trouble. Wait a while and try again.

---

**Connection interrupted**

...Disconnected from the personal computer during data communication.

---

---

**Connection is not valid**

...The destination address set by Host Selection is not compatible, so you cannot operate. Check the setting and try again. (See page 166)

...The user certificate is being operated, so you cannot connect. Complete operating the user certificate and try again.

---

**Could not add**

...An error occurred, so you could not store.

---

**D**

---

**Data in IC card is full****Unable to download****Delete service?**

...This is displayed when the memory space within the IC card is short for downloading the i-appli program that supports Osaifu-Keitai.

Select “YES” to display the service names of Osaifu-Keitai already registered and the space within the IC card (in bytes). Check the area size for shortage, select the service to delete, start up the i-appli program, and then delete it.

---

---

**Data is full**

...The maximum number of anniversaries is stored.

Delete unnecessary ones and try again.

(See page 361, page 362)

...The maximum number of holidays/anniversaries is stored. Delete unnecessary ones and try again. (See page 361, page 362)

...The maximum number of holidays is stored. Delete unnecessary ones and try again.

(See page 361, page 362)

...The maximum number of Phonebook entries has been stored in the FOMA phone, so you could not receive a new one. Delete unnecessary Phonebook entries and try again. (See page 85)

...The maximum number of schedule events has been stored in the FOMA phone, so you could not receive a new one. Delete unnecessary schedule events and try again. (See page 361, page 362)

...The maximum number of ToDo items has been stored in the FOMA phone, so you could not receive a new one. Delete unnecessary ToDo items and try again. (See page 364)

---

**Data is too long****A part is deleted**

...Characters for one (or plural) of address, subject, and text of the mail exceeded the maximum, so part of them was deleted.

---

**Data not applicable**

...Received data has an error, so cannot be displayed or saved. The received data is discarded.

---

**Data size is too big to save**

...The file exceeded the maximum storable size by setting “File restriction”, so could not be set.

---

**Details cannot be saved**

...The ToruCa detailed data was not supported, so was not saved.

---

**Downloaded data exists****Cannot connect to network**

- ... Save the PC movie on the Obtaining Completion display, and then close the Obtaining Completion display. (See page 273)

**Downloading interrupted**

- ... Another function was running or an error occurred, so you could not download.

**E****Editing now****Cannot delete**

- ... Being used for another function, so you cannot delete. End the function and try again. (See page 354)

**Enter zoom size**

- ... No magnification is entered. Enter the magnification and try again. (See page 325)

**Enter "+" in right position**

- ... "+" is wrongly positioned. Enter it to the beginning of the phone number. (See page 58)

**Error**

- ... An error occurred, so you could not operate.

**Error in image****Does not work correctly**

- ... The Flash movie had an error, so you could not play it back normally.

**F****Failed in  transmission**

- ... An error occurred, so you could not perform iC transmission.

**Failed to authenticate**

- ... An authentication error occurred.

**Failed to get license file**

- ... Failed to obtain the license information about the PC movie, so cannot be played back.

**Failed to read**

- ... An error occurred while reading information from the microSD card.

**Failed to read****Quitting**

- ... An error occurred when playing back the moving image.
- ... The file cannot be read because you tried to play back the file in the "Movable contents" folder with a UIM that was not inserted when that file was saved. Insert the UIM that was inserted when the file was saved, and try again. (See page 37)
- ... The microSD card was removed while reading the information from it. Insert the microSD card and try again. (See page 305)

**Failed to receive channel info**

- ... Failed to obtain the i-Channel information because part or all of it could not be obtained.

**Failed to save**

- ... An error occurred, so you could not copy the ToruCa file.
- ... An error occurred, so you could not save.
- ... An error occurred, so you could not store.
- ... You could not save the shot image.

**Failed to send Ir data**

- ... An error occurred, so you could not send the data using infrared rays.

**Failed to set**

- ... An error occurred, so you could not set.

**Format error****Insert microSD formatted**

- ... The format of the microSD card is incompatible with FOMA P706ij. Use FOMA P706ij to format it. (See page 312)

**I**** Oppli stand-by display terminated due to security error**

- ... i-Oppli DX has forcibly been ended. (See page 223)

** Oppli To function is not set****" Oppli To" function is not set**

- ... A check mark is not put for "Set  Oppli To", so you cannot start up the i-Oppli program. Put a check mark and try again. (See page 223)

**IC card function inactive****Unable to download**

- ... IC card has been locked, so you could not download or upgrade. Release IC Card Lock and try again. (See page 246)

**Image display is OFF****Cannot receive**

- ... "Set image display" is set to "OFF", so you cannot obtain the image. Set to "ON" and try again. (See page 165)

**Image in message will be deleted**

- ... The output-prohibited image from the FOMA phone is attached to the mail text, so deleted.

**i-mode Center is busy****Please try again later (555)**

- ... The line facility has trouble or the line is very busy. Wait a while and try again.

**i-mode mail service is busy****Please try again later (553)**

- ... The line is very busy. Wait a while and try again.

**Incomplete data****Unable to start**

- ... The i-Oppli program you tried to start up does not start because partial data only is saved. Download the whole i-Oppli program and try again. (See page 220)

**Input error (205)**

- ... The entered contents are wrong. Check the contents and try again.

**Input too long**

- ... Too many entered characters to send. Decrease the number of characters and send again. (See page 152)

---

## Invalid

### Cannot resend

... The address is invalid or the text exceeds the size that can be entered, so you cannot re-send.

---

### Invalid code

... The entered USSD is incorrect. Enter the correct one.  
(See page 402)

---

### Invalid data

- ... Received data has an error, so cannot be displayed or saved. The received data is discarded.
- ... You cannot play back the following PC movies:
  - The data files other than Windows Media files or the files with invalid contents
  - The data file whose image size is larger than 320 dots x 240 dots, image bit rate is higher than 2 Mbps, or voice bit rate is higher than 385 kbps
  - If the server returns an unidentified response when you try to download a savable data file.
  - When the streaming server is not supported by the FOMA phone (The streaming servers supported by the FOMA phone is Windows Media Services 9 only.)

---

### Invalid data (XXX)

... Received data has an error, so cannot be displayed or saved. The received data is discarded.  
A three-digit numeral is displayed for (XXX).

---

### Invalid data

#### Data size is not supported (XXX)

... Received data has an error, so cannot be displayed or saved. The received data is discarded.  
A three-digit numeral is displayed for (XXX).

---

### Invalid func in this UIM

... The function cannot be operated from the inserted UIM.

---

## Invalid UIM auto start not display

---

### Invalid UIM

#### **oppli is unable to run**

... You cannot start up the i-oppli program because of the UIM security function. Insert the UIM which had been inserted when the i-oppli program was downloaded and try again. (See page 37)

---

### Invalid UIM

#### **Incorrect display**

... The screen memo cannot be correctly displayed because of the UIM security function. Insert the UIM that had been inserted when the screen memo was saved, and try again. (See page 37)

---

### Invalid UIM

#### **Requested service not available**

---

#### **Invalid UIM requested service not available**

... You cannot operate because of the UIM security function. Insert the UIM which had been inserted when the data or file was obtained and try again.  
(See page 37)

---

### Invalid UIM

#### **Requested software failed to start**

---

#### **Invalid UIM requested software failed to start**

... You cannot start up the i-oppli program because of the UIM security function. Insert the UIM which had been inserted when the data or file was obtained and try again. (See page 37)

---

## Invalid UIM

### Unable to delete

---

### Invalid UIM

#### **Unable to download**

---

### Invalid UIM

#### **Unable to move**

---

### Invalid UIM

#### **Unable to start**

---

### Invalid UIM

#### **Unable to upgrade**

... You cannot move, start up, delete, download or upgrade because a UIM different from the one set for the IC card is inserted. Insert the UIM set for the IC card, and try again. (See page 37)

---

### Invalid URL

... The URL is invalid, so you cannot connect to the site or the Internet web page.

---

## L

### **Linked page is not downloaded**

... The PDF data file has a link but the linked end has not been downloaded, so the linked page could not be displayed.

---

## M

以下の宛先にはメール送信できませんでした (561)

**Mails could not be sent to following address. (561)**

●●@△△△.ne.jp※

... You could not send the mail message correctly to the displayed address.

※ The mail address differs depending on the destination.

---

### **Max cost icon is not displayed**

... The Max Cost icon is not displayed, so cannot be deleted.

---

### **Memory full**

... There is no usable memory space, so you cannot operate.

---

### **Memory function active**

#### **Cannot operate**

... The microSD card is in use, so you cannot set.

**Memory No. : XXX****Cannot overwrite**

... You cannot store in the same memory number with the Phonebook entry stored as secret data. Store in a different memory number.

A three-digit numeral is displayed for (XXX).  
(See page 80)

**Memory shortage**

... The memory space is not enough, so processing is suspended. If displayed frequently, turn off and on the power. (See page 43)

**Memory shortage****Cancel update****Memory shortage****End document viewer****Memory shortage****Failed to create font effect****Memory shortage****Return to Access Setting****Memory shortage****Return to Full Browser menu****Memory shortage****Return to i-mode menu****Memory shortage****Return to ToruCa list**

... The memory space is not enough, so processing is suspended.

**N****Network is not found**

... You cannot connect to the specified network. However, the connection is completed if the antenna icon appears afterward.

**No channel info**

... The channel information cannot be downloaded, so recommended channel mail cannot be composed.

**No data in phonebook****Cannot operate**

... The phone number and mail address of the other party are not stored in the Phonebook. Store them and try again. (See page 79)

**No picture**

... No frames to fit the size are found.

**No response**

... Sending end was not found while using iC communication.

**No response (408)**

... No response from the site or Internet web page, so you could not connect to it. Try again.

**No set melody**

... This is displayed when you try to play back melodies with the playlist unprogrammed. Program the melodies and then play them back. (See page 316)

**Not notify phone No.****Cannot operate**

... You could not start up because the other party's phone number was not notified.

**Not registered**

... An error occurred, so you could not store.

**O****Operation failed**

... An error occurred, so you could not set.

**Operation may not be performed**

... The microSD card is removed while it is in progress or an error occurred, so it might be possible that no operation is done. Check the "Movie" folder for the data. (See page 290)

**Other function active****Cannot operate**

... The function is not available simultaneously in Multitask. End the functions not in use and try again. (See page 354)

**Out of service****Out of service area**

... Radio waves are not received. Move to a place where the radio waves are strong enough and try again.

**P****Page is not found (404)**

... The site or Internet web page does not exist, or URL is wrong. Check the URL and try again.  
(See page 155)

**PIN1 code blocked****PIN1 code blocked****Enter PUK****PIN1 code not recognized**

... Three times erroneous entry of the PIN1 code blocks the code. Enter the PUK (PIN unlock code).  
(See page 116)

**Please set "To type" receiver**

... No address is in the "To" field. Fill in the "To" field and try again. (See page 174, page 176)

**Please wait**

... The audio line/packet communication facility has trouble or the audio line network/packet communication network is very congested. Wait a while and try again. You can make calls at 110/119/118. However, calls might not be connected by the situation.  
... The packet communication facility has trouble or the packet communication network is very congested. Wait a while and try again.

**Please wait for a while**

... The audio line/packet communication facility has trouble or the audio line network/packet communication network is very congested. Wait a while and try again. You can make calls at 110/119/118. However, calls might not be connected by the situation.

**Please wait for a while (packet)**

... The packet communication facility has trouble or the packet communication network is very congested. Wait a while and try again.



## Preparing

### Cannot record

... You cannot record just after recording. Wait a while and try again.

### Protected all

#### Cannot delete

... All data items are protected, so cannot be deleted. Release the protection and try again.  
(See page 159, page 196, page 207)

### Protected

#### Cannot delete

### Protected mail

#### Cannot delete

### Protected memo

#### Cannot delete

### Protected message

#### Cannot delete

... Protected data, so could not be deleted. Release protection and try again. (See page 207)

### PUK blocked

### PUK code blocked

### PUK code not recognized

... Ten times erroneous entry of the PUK (PIN unblock code) blocks the code. Contact the handling counter of a DOCOMO shop.

## R

### Read error

... An error occurred while reading information from the microSD card.

### Received invalid data

... Received data has an error, so it cannot be displayed or saved. The received data is discarded.

### Receiver cannot save data

... The receiving end blocks data.

### Receiving failed

... The destination address set by Host Selection is wrong, so you cannot select and receive. Check the setting and try again. (See page 166)

### Registration is in progress (554)

... You cannot operate because the user is being registered. Wait a while and try again.

### Replace with a new one or check the disk

... The microSD card formatting is abnormal. Execute Check microSD. (See page 313)

### Replay period has not yet started

... Playable date has not come yet, so you cannot play back the file.

### Retention period has expired (492)

... You could not download attached files held at the i-mode Center because the save period had been over.

### Rewrite failed

... Failed to update the software program. Contact a handling counter such as a DOCOMO shop.

### Root certificate has expired

#### Terminate SSL session

... Expiration date of SSL certificate has passed, so the connection is suspended.

### Root certificate is not valid

... The SSL certificate of that server is set to "Invalid" for "Certificate" setting. Set to "Valid" and try again. (See page 167)

... The SSL/TLS certificate of that server is set to "Invalid" for "Certificate" setting. Set to "Valid" and try again. (See page 167)

### Run software and delete data on IC card

#### Then delete software

... Data is left inside the IC card, so you cannot delete the Osaifu-Keitai compatible i-oppli program. Start up the Osaifu-Keitai compatible i-oppli program, delete the stored data, and try again.

## S

### Secret data

... You have not switched to Secret Mode or Secret Data Only, so cannot access. Switch to Secret Mode or Secret Data Only and try again. (See page 120)

### Server is busy

... The line facility has trouble or the line is very busy. Wait a while and try again.

... The line is very busy. Wait a while and try again.

### Service is used by a previous software

#### Unable to download

#### Delete a service?

### Service is used by a previous software

#### Unable to upgrade

#### Delete a service?

... When the software program with the service that uses the same IC card has already been downloaded, you cannot download or upgrade a new service unless you delete the existing service that has already been stored. Select "YES" to display the service to be deleted, and then delete that service already stored.

### Service unavailable

... The function cannot be operated with the inserted IUM.

### Setting auto assist

#### Cannot delete

### Setting auto assist

#### Cannot delete all

... The country code or international call access code set by Auto Assist Setting cannot be deleted. Change/Cancel the setting and try again.  
(See page 59)

### Setting IC card lock

... IC Card Lock is set. Release IC Card Lock and try again. (See page 246)

### Setting receive option

#### Cannot start

... Receive Option Setting is set to "ON", so you cannot start up. Switch to "OFF" and try again.  
(See page 186)

**Size of data is not supported**

…Data size exceeded the maximum, so you could not download normally.

**Size of page is not supported****Size of this page is not supported**

…The size of site or Internet web page is large, so obtaining is suspended, and only obtained portion is displayed.

**Software for this folder deleted****Refer to Open folder**

…The corresponding mail-linked i-oppli program has been deleted.

**Software for this folder exists****Cannot delete**

…The corresponding mail-linked i-oppli program is contained, so you cannot delete.

**Software terminated due to security error**

…i-oppli DX has forcibly been ended. (See page 223)

**Software update active****Cannot operate**

…You could not start up during updating the software program. After the software update is completed, try again.

**Software update is aborted****Please retry**

…The FOMA phone was turned off during updating the software program. Try updating it again. (See page 465)

**Software upgraded**

…The target software program is not updated, so you cannot execute.

**Some addresses are not valid**

…Some addresses are incorrect. Enter the addresses correctly and send. (See page 174, page 214)

**Some data could not be copied**

…The selected files contained ones that could not be copied, so you could not copy some data.

**Some data could not be moved**

…The selected files contained ones that could not be moved, so you could not move some data.

**Some data could not be saved**

…The selected files contained ones that could not be copied to the FOMA phone or microSD card, so you could not save some data.

**Sort is full****Cannot add**

…The maximum number of settings is already set. Release unnecessary settings and try again. (See page 203)

**Specified page number is not valid**

…The entered page number is invalid. Enter the correct page number and try again. (See page 324)

**Specify max cost within ¥10-100,000**

…Set the limit of Notice Call Cost to ¥10 through ¥100,000. (See page 368)

**SSL session cannot be established**

…Either an altered SSL certificate was received or an SSL error occurred, so you could not connect.

**SSL session failed**

…An authentication error occurred at the server, so you cannot connect.

**SSL/TLS session cannot be established**

…Either an altered SSL/TLS certificate was received or an SSL/TLS error occurred, so you could not connect.

**SSL/TLS session failed**

…An authentication error occurred at the server, so you cannot connect.

**Syntax error**

…Received data has an error, so cannot be displayed or saved. The received data is discarded.

**System is restarted**

…An error occurred, so the system is restarted and then the Stand-by display returns.

**T****This certificate has expired****Terminate SSL session**

…Expiration date of SSL certificate has passed, so the connection is suspended.

**This certificate is not valid for this URL****Terminate SSL session**

…The contents of this SSL certificate do not match, so the connection is suspended.

**This data is not valid**

…You are trying to paste characters that cannot be used. Check the characters to be pasted and try again. (See page 381)

**This file is not attachable****Cannot resend**

…The output-prohibited file from the FOMA phone has been attached to the mail, so you could not re-send it.

**This file is not valid**

…The file is incompatible, so cannot be displayed.

**This image is not valid**

…The image could not be displayed normally, so cannot be saved. Even if normally displayed, it may not be saved depending on the file format.

**This mail is broken****Cannot resend**

…The size of the mail text is too large or the attachment information about the text is damaged, so you could not re-send.

**This picture is not valid**

…The image data is invalid, so cannot be displayed.

**This site is not verified****Terminate SSL session**

…This SSL certificate was not supported, so the connection was suspended.

**This software contains an error****This software contains an error****Unable to download**

...The software program contains invalid data, so cannot be downloaded or upgraded.

**This software is currently unavailable for use**

...You cannot start up the software program because the effective period is expired or the server has put it in unavailable state.

**This software is not supported by this phone**

...The software program to be downloaded or upgraded does not support the FOMA phone.

**This software is presently out of use**

...You cannot start up the software program because the effective period is expired or the server has put it in unavailable state.

**This UIM cannot be recognized**

...An error occurred on the UIM or the PUK (PIN unblock code) is blocked. Contact the handling counter of a DOCOMO shop.  
...Check to see if the correct UIM is inserted.  
(See page 37)

**This UIM cannot be recognized****Phone is restarted**

...This UIM cannot be recognized correctly.  
The system is restarted and then the Stand-by display returns.

**Too much data was entered**

...Too many entered characters to send. Decrease the number of characters and send again.  
(See page 152)

**Transmission failed****Transmission failed (552)****Transmission failed (XXX)**

...You could not send the mail correctly. A three-digit numeral is displayed for (XXX).

**U****Unable to acquire remaining data****Delete data****Unable to acquire remaining data, Data deleted.**

...An error occurred when downloading the remaining data of the file that was partially saved, so the data was deleted.

**Unable to activate 1Seg.****Please activate the application after moving to FOMA coverage**

...You repeatedly watched 1Seg programs out of the service area where you cannot connect to, so you cannot start 1Seg. Move yourself into the FOMA service area where you can connect to, and then try to start 1Seg again.

**Unable to change title**

...You could not edit the title because entering no characters or entering only space is disabled while editing the title. Enter characters and try again.  
(See page 283)

**Unable to combine/bind**

...You could not concatenate the scanned data. The scanned data up to now is discarded.

**Unable to compose****Unable to compose message**

...You could not compose i-mode mail because the FOMA phone was reading data. Wait a while and try again.

**Unable to download**

...Another function was running or an error occurred, so you could not download.  
...The data is invalid, so cannot be downloaded.  
...The maximum number of programs has already been saved or there is not enough memory, so you could not download the program.

**Unable to download****Cancel update**

...Another function was running or an error occurred, so you could not download.

**Unable to download****Data exceeds maximum size**

...You tried to download the PDF data file exceeding the maximum size, so could not download it.

**Unable to download****Data exceeds maximum size (452)**

...You tried to receive data exceeding the maximum size, so could not receive it.

**Unable to edit file name**

...You cannot change the file name to the one starting with a period or containing prohibited characters except half-pitch alphanumeric characters. Enter the correct file name and try again. (See page 284)

**Unable to input because of exceeding maximum size**

...You could not enter the Deco-mail pictogram because it exceeded the maximum size of the images to be inserted.

**Unable to move**

...The i-oppli program is the one that cannot be moved to the FOMA phone, so could not be moved from the microSD card to the FOMA phone.

**Unable to play because of wrong UIM or license info**

...This music file cannot be played back because of the UIM security function. Insert the UIM you used for obtaining the Chaku-uta Full® music file, and try again. If the UIM is the one inserted for obtaining the Chaku-uta Full® music file, the license information of the music file in the FOMA phone is invalid, so cannot be played back. Perform "Initialize" and try again. (See page 373)

**Unable to retrieve the requested URL (504)**

...No response from the server, so you cannot connect.

**Unable to save**

...The data could not be obtained from a site, so could not be saved.

**Unable to search any available channels****Unable to search any channels**

...No broadcasting station was found that can receive programs currently in the area.

**Unable to select**

...When selecting the end point for "Trim  motion", you tried to select the point before the start point or the same point as the start point. So, the end point could not be selected. Reselect the start point again, then proceed. (See page 295)

**Unable to send all Ir data**

...All the selected files were output-prohibited from the FOMA phone, so could not be sent.

**Unable to set**

...An error occurred, so you could not set.

**Unable to set auto-update**

...An error occurred, so you could not set "Set auto-update".

**Unable to set for storage**

...There are no unoccupied memory numbers within the folder, so you cannot set.

**Unable to support this card**

...The inserted memory card cannot be used on FOMA P706ijμ. Use FOMA P706ijμ compatible microSD card. (See page 305)

**Unable to switch audio data**

...There is only one audio, so you cannot switch.

**Unable to upgrade**

...An error occurred, so you could not upgrade.

**Unable to use this function**

...The function cannot be operated with the inserted UIM.

**Unable to write**

...You cannot write on the microSD card because it is write-protected. Use external devices to unlock the protection and try again.

**Unsupported contents exist**

...The data that the FOMA phone does not support is contained.

**Update pattern definitions**

...An error occurred, so you cannot use Scanning Function. Update the pattern data and try again. (See page 471)

**Updating program**

...The program of Music&Video Channel is updating, so you cannot download or play it back. Wait a while and try again.

**URL address is not valid****URL address is not valid (XXX)**

...Received data has an error, so cannot be displayed or saved. The received data is discarded.  
A three-digit numeral is displayed for (XXX).

**Usage is currently restricted****Try again later**

...When a Pake-Houdai/Pake-Houdai Full user communicates a large amount of data within a certain duration, the connection might be restricted for a certain duration. Wait a while and try again.

**Using mail folder****Cannot delete****Using mail folder****Cannot download****Using mail folder****Cannot start**

...Corresponding software program is running. End the software program and try again. (See page 222)

**W****Wait for a while to retry**

...Currently, it is placed inactive. Wait a while and try again.

**Wrong PIN1 code**

...The entered PIN1 code is wrong. Enter the correct one. (See page 114)

**Y****Your HTTP version is not supported (XXX)**

...Received data has an error, so cannot be displayed or saved. The received data is discarded.  
A three-digit numeral is displayed for (XXX).

## Warranty and Maintenance Services

### Warranty

- Make sure that you have received a warranty card provided at purchase. After checking the contents of the warranty card as well as "Shop name and date of purchase", keep the warranty card in a safe place. If you notice that necessary items of the warranty card are not filled in, immediately contact the shop where you purchased the FOMA phone. The term of the warranty is one year from the date of purchase.
- All or part of this product including the accessories may be modified for improvement without notice.
- Data stored in the Phonebook and others might be changed or lost owing to a malfunction, repairs, or other mishandling of your FOMA phone. You are advised to take a note of Phonebook entries and other files in preparation for such incidents. After we repair your FOMA phone, we cannot move, with some exceptions, the information downloaded by using i-mode or i-oppli to your repaired FOMA phone because of the copyright law.
  - ※ The FOMA phone enables you to save Phonebook entries, i-motion movies, or data files used for i-oppli to the microSD card.
  - ※ You can use Data Security Service (pay service that is available on a subscription basis) to save the data files such as Phonebook entries from the FOMA phone to the Data Storage Center.
  - ※ If you have a personal computer, you can transfer and save the data files from the Phonebook to your personal computer by using the DOCOMO keitai datalink (see page 410) via the FOMA USB Cable with Charge Function 01/02 (option) or FOMA USB Cable (option).

### Maintenance Services

- **When there is a problem with the FOMA phone**  
Before asking repairs, check "Troubleshooting" in this manual.  
If the problem remains unsolved, contact the "Repairs" counter listed on the back page of this manual for malfunction and consult them.
- **When repairs are necessitated as a result of consultation:**  
Bring your FOMA phone to a repair counter specified by DOCOMO. Note that your FOMA phone is accepted for repair during the repair counter's business hours. Also, make sure that you will bring the warranty card with you to the counter.
  - **In warranty period**
    - Your FOMA phone is repaired charge free in accordance with the terms of warranty.
    - Make sure that you bring the warranty card to the counter for the repair. If you do not show the warranty card, or when troubles or malfunctions are regarded to be caused by your mishandling, the repair cost is charged even within the warranty period.
    - The cost for troubles caused by the use of devices and consumables other than those specified by DOCOMO is charged even within the warranty period.
    - For the damages of liquid crystal display, connector, etc. after purchase, the repair cost is charged.
  - **Repairs may not be performed in the following cases:**
    - When exposure to water is found at our repair counter (Example: When the waterproof sticker reacts)
    - When, as a result of inspection at our repair center, corrosion is found due to exposure to water, dew condensation, or sweat, or when damage or deformation is found in the circuit board [Repairs might not be carried out when damage to the connector terminal (Earphone-Microphone terminal) or LCD, or cracks in the body are found.]
- ※ Even if repair is feasible, it is not covered by the warranty, so that repair cost is charged.
- **After the warranty period**  
We will repair your FOMA phone on request (charges will apply).
- **Spare parts availability period**  
The minimum storage period of the performance spare parts (parts required for maintaining performance) for the FOMA phone is basically six years after the closure of its production. Note, however, that your FOMA phone might not be repaired depending on the parts because of shortage of the spare parts. Even after the storage period, some FOMA phones can be repaired depending on the troubled portions. Contact the "Repairs" counter listed on the back page of this manual.

### Other points to note

- Make sure not to modify the FOMA phone or its accessories.
  - Catching fire, giving injury, or causing malfunctions may result.
  - For the repair of devices that the modification is applied to, we accept it if you agree to have the modification reset. Further, we might reject to repair depending on the conditions of the modification.
- The following might be regarded as modifications:
  - To put stickers, etc. onto the liquid crystal display or keys
  - To decorate the FOMA phone using adhesives
  - To replace the coverings etc. with those of other than DOCOMO genuine
- Repairs of troubles or malfunctions resulting from the modifications are charged even within the warranty period.
- Do not peel the nameplate off the FOMA phone.

The nameplate is a certificate for ensuring the technological standard. If someone intentionally peel off the nameplate or replace it, the contents described in the nameplate cannot be checked, as we cannot verify the conformity of the product to the technical standard. Note that we may refuse repair for some malfunctions in this case.

- The information such as function settings and Total Calls Duration, etc. might be reset depending on troubles or repairs, or the way you handle the FOMA phone. Set the settings again.
- The following parts of the FOMA phone uses the parts generating magnetic field:
  - Note that if you put a card such as cash card liable to be influenced by magnetic field close to it, the card might be adversely affected.
  - Using parts: speaker, earpiece
- If the FOMA phone gets wet or becomes moist, immediately turn off the power and remove the battery pack; then visit a repair counter. The FOMA phone may not be repaired depending on its condition.

### Memory dial (Phonebook function) and downloaded information

- It is recommended to take a note of the information you have stored in the FOMA phone and keep it in a safe place. We are not responsible for any change in or loss of information.
- When replacing or repairing your FOMA phone, the data you created, obtained from external devices, or downloaded may be changed or lost. We do not take any responsibility for the loss or change incurred to the data. We may replace your FOMA phone with a new one instead of repairing, for our convenience sake. With this FOMA phone, we move the files including the images and ring melodies downloaded to the FOMA phone or the files you created to the new FOMA phone so far as your existing FOMA phone is troubled or repaired. (We cannot move some files. Also, some files might not be movable depending on the degree of malfunction.)

※ It may take a while to move files, or it might occur that moving files is not possible depending on the memory size of the files stored in the FOMA phone.

## i-mode Trouble Diagnosis Site

You can check on your FOMA phone whether sending/receiving mail messages, downloading images/melodies, and others are normally working.

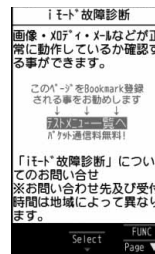

Top display

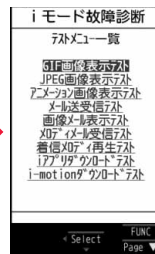

Test Menu list

- To connect to “iモード故障診断サイト (i-mode Trouble Diagnosis Site)” i-mode site:
  - ☎ Menu→お知らせ (News)→サービス・機能 (Services & Functions)→iモード (i-mode)→iモード故障診断 (i-mode Trouble Diagnosis) (Japanese only)



QR code for accessing the site

- A packet communication fee for connecting to the i-mode Trouble Diagnosis Site is free. (When you access it from overseas, you are charged the fee.)
- The test items differ by model of FOMA phones. Further the test items might be changed.
- When you check operations of your FOMA phone according to each test item, read the cautions on the site thoroughly and then perform the test.
- When you connect to the i-mode Trouble Diagnosis Site and test on sending mail messages, the proper information about your FOMA phone (model name, mail address, etc.) is automatically sent to the server (i-mode Trouble Diagnosis Server). We never use the sent information for other purposes than for the i-mode trouble diagnosis.
- When you think your FOMA phone is in trouble as a result of your check, contact the “Repairs” counter listed on the back page of this manual.

## Updating Software

This function is to check whether you need to update software programs in the FOMA phone by connecting to the network, and if necessary, you can download some parts of software programs using packet communication, and can update the software programs.

※ You are not charged a packet communication fee for updating software programs.

If you need to update the software programs, the DOCOMO web page and “お知らせ (News)” in ☎ Menu let you know about it.

“Auto-update”, “Update Now” and “Reserve Update” are available for updating software programs.

**[Auto-update]:** Automatically downloads new software programs, and updates at the time you specified beforehand.

**[Update Now]:** If you want to, immediately update.

**[Reserve Update]:** Reserve the date and time for updating software programs, and they are automatically updated at the reserved date and time.

- Do not remove the battery pack while updating software programs. You may fail to update.
- You can update software programs with the Phonebook entries, images shot by the camera, or downloaded data retained in the FOMA phone; however note that data may not be protected depending on the conditions (such as malfunction, damage, or drench) your FOMA phone is placed in. You are advised to backup important data. Note that some data such as downloaded ones might not be backed up.

### ■ Before Using Software Update

- You can update software programs even when you set “Host selection” to a user designated destination.
- Fully charge the battery before updating software programs.
- You cannot update software programs in the following cases:
  - When the FOMA phone is off
  - During a call
  - During PIN1 code lock
  - During Self Mode
  - When the UIM is not inserted
  - While connecting to external devices such as a personal computer
  - When date and time are not set
  - Out of the service area
  - During Omakase Lock
  - While using other functions
- It may take time to update (download or rewrite) software programs.
- You cannot make/receive calls, use communication functions, and use other functions while updating software programs.  
(You can receive voice calls, forward calls or operate Record Message during download.)
- When updating, the FOMA phone is connected to the server (DOCOMO site) using SSL communication. You need to validate the SSL certificate.  
(Setting at purchase: Valid See page 167 for how to set.)
- It is recommended to update software programs when radio wave is strong enough with the three antennas displayed and while you are not moving.
  - ※ If radio wave conditions get worse while downloading software programs, or download is suspended, move to a place with good radio wave conditions and try again to update software programs.
- If you check Software Update with the software programs already updated, the message “No update is needed Please continue to use as before” is displayed.
- When “Receive option setting” is set to “ON” and mail comes in during software update, the display for notifying you of the arrival of mail may not be displayed after software update is completed.
- When updating software programs, the proper information about your FOMA phone (model name or serial number, etc.) is automatically sent to the server (DOCOMO-managed server for Software Update). We at DOCOMO never use the sent information for other purposes than for updating software programs.
- If you fail to update software programs, “Rewrite failed” is displayed and you cannot do all the operations. In that case, you are kindly requested to come to a repair counter specified by DOCOMO.
- You cannot use Software Update overseas.

## Update Software Programs Automatically <Set Auto-update>

You can download new software programs automatically, then the updating is operated at the time you specified beforehand.

When the rewriting state is ready, the “Rewrite notification” icon appears. Then you can confirm the rewrite time and select whether to change the rewrite time or rewrite the program immediately.

- You cannot change “Set auto-update” when the notification icon of software update is displayed on the Stand-by display. In that case, select the notification icon, and clear that icon without confirming whether the software update is required. You are then able to change “Set auto-update”.

### 1 Set the date/time of updating.

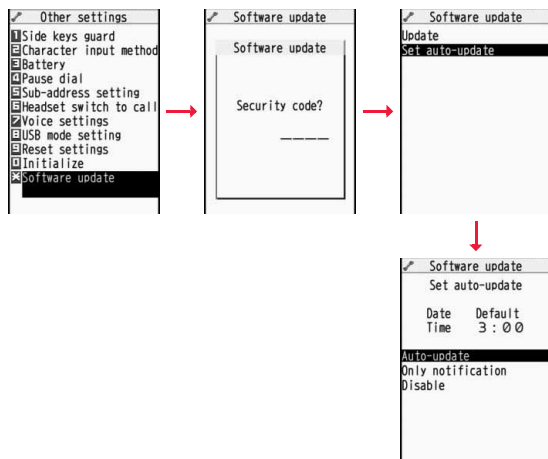

### 2 Select the “Rewrite notification” icon on the Stand-by display, and select “OK”, “Change time” or “Now rewrite”.

- ※ The “Rewrite notification” icon notifies you that rewriting starts at the set time. (It is cleared when you check it.)

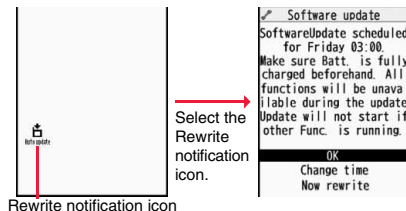

#### When you select “OK”

- ※ After you select it, the Stand-by display returns, and then rewriting starts at the set time.





## When you select “Change time”

You can set the time and day of the week for rewriting.

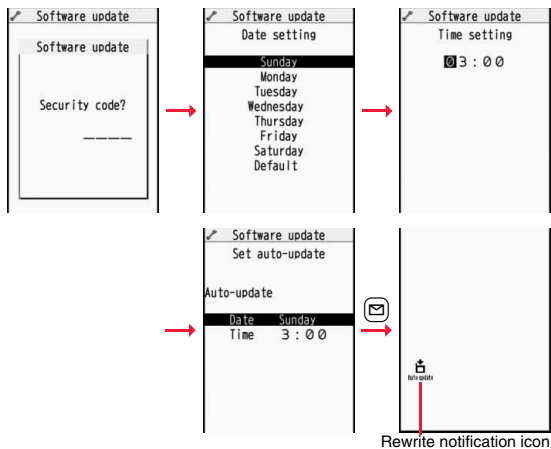

Rewrite notification icon

## When you select “Now rewrite”

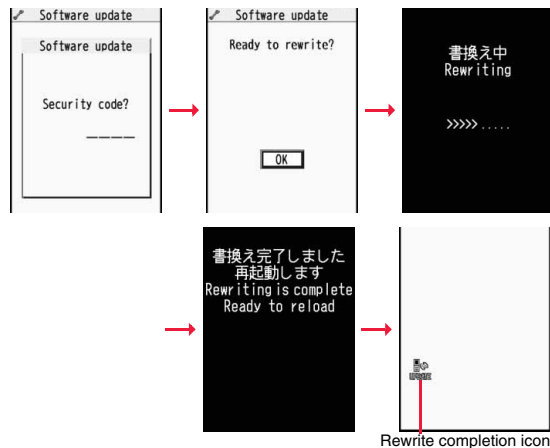

Rewrite completion icon

※“Rewrite completion icon” appears only when you select “Now rewrite”.

## Start Software Update

If you select “Only notification” of “Set auto-update”, “Update notification icon” notifies you when software update is necessary. You can start Software Update by selecting “Update notification icon”, or from the Menu display.

### Start Software Update by Selecting “Update notification icon”

#### 1 Select “Update notification icon” on the Stand-by display.

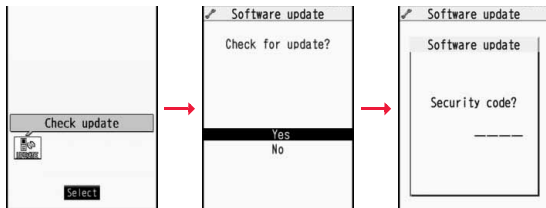

- If you select “No”, the confirmation display appears asking whether to delete the notification icon.
- “Update notification icon” appears in the following cases:
  - When notification is provided by DOCOMO
  - When “Update is needed” is displayed in step 3 on page 468
  - When you fail to update software programs during updating in Reserve Update
  - When you cancel the reservation for the software update

#### 2 Check whether the software programs need to be updated.

- You can answer voice calls during check.

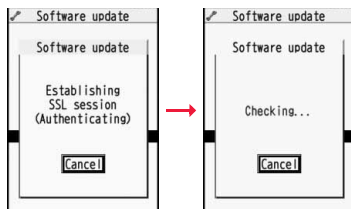

#### 3 When updating is not necessary, “No update is needed” is displayed. Use the FOMA phone as it is. When updating is necessary, “Update is needed” is displayed. You can select either “Now update” or “Reserve”.

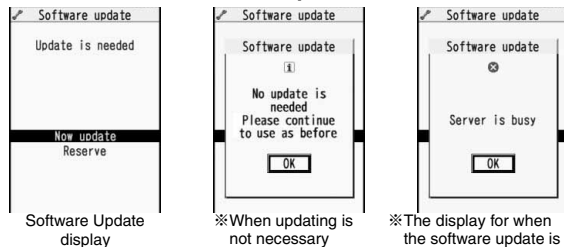

### Start Software Update from Menu

#### 1 Settings > Other settings > Software update > Enter your Terminal Security Code > Update

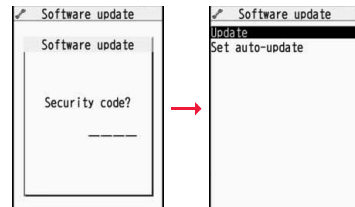

#### 2 Go to step 2 of [Start Software Update by Selecting “Update notification icon”] on page 468.

## Update Software Now (Update Now)

**1** When you select “Now update”, “Start download” is displayed and downloading starts after a while. (Select “OK” to start downloading right now.)

- You can answer voice calls during download.
- If you cancel downloading midway, the data downloaded up to that point is deleted.
- Once downloading starts, updating proceeds automatically; you do not need to select menu items.

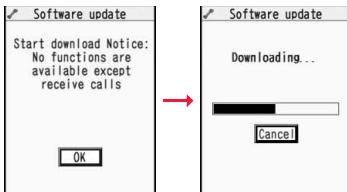

**2** When downloading is completed, rewriting the software programs starts. (Select “OK” to start rewriting right now.)

When rewriting is completed, your FOMA phone automatically restarts.



- It may take a while to start rewriting.
  - You cannot even answer calls while rewriting.
- ※While rewriting the software programs, all key operations are disabled. You cannot even stop updating.  
Also, charging temporarily stops even if the AC adapter (option) is connected.

**3** After confirming the update completion, select “OK”.



## Reserve Date and Time for Updating Software (Reserve Update)

When downloading takes time or the server is busy, you can set in advance the date and time for starting the software update by communicating with the server.

**1** Select “Reserve” from the Software Update display.

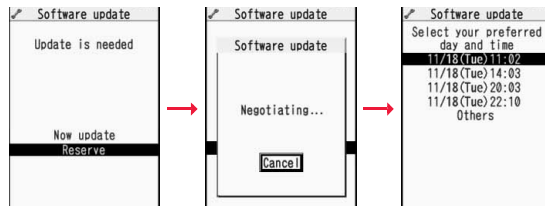

The date and time which can be reserved are displayed.

- The server's time table appears for the software update reservation.

**When you select “Others”**

After communicating with the server, you can select the date and time you want. The availability of each time zone is displayed on the time selection display as follows:

○: Available, △: Almost full, ×: Not available

When you select one time zone you want, you can communicate with the server again to display candidates for reserving time.

- 2** Confirm the date and time you selected. Select **“YES”**. Your FOMA phone communicates with the server again and then the reservation is completed.

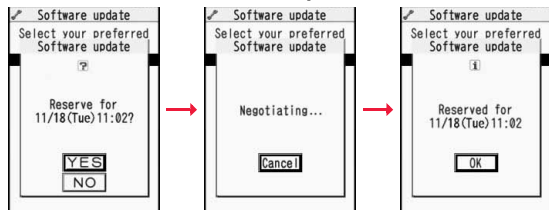

### When the reserved time comes

The display on the right appears and about five seconds later the software update starts automatically.

Before the reserved time, fully charge the battery pack, place the FOMA phone with the Stand-by display shown in a place within reach of radio wave.

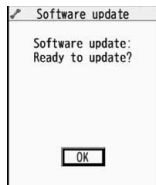

#### Information

- Note that updating may not start even when the reserved time arrives if you are using another function.
- The software update may not be started if an alarm is activated.
- If you execute "Initialize" on page 373 after completing the reservation, the software update does not start even when the reserved time arrives. Make a reservation for the software update again.

### Check, Change, or Cancel the Reserved Date and Time

Select **“Software update”** from the setting menu, then enter your **Terminal Security Code** and select **“Update”**; then you can confirm the reserved time.

You can change or cancel the reserved date and time from the display for checking reservation. To change, select **“Change”**. To cancel, select **“Cancel”**.

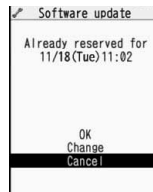

### End Software Update

If you select **“NO”** or **“Cancel”** from each display, the display for ending the operation appears.

Select **“YES”**; then the software update ends and the Stand-by display returns. To return to the previous display, select **“NO”**.

#### Information

- If the battery level points **“”** during operation, the software rewriting is not done and the operation ends.

## <Scanning Function>

# Protecting FOMA Phone from Data Causing Failure

First of all, update the pattern data to make it the latest.

Regarding data and programs downloaded or obtained from sites, i-mode mail messages or SMS messages to the FOMA phone, you can detect data that might cause failure, can delete it, and can stop starting an application program.

- Use the pattern data for checking. Update the pattern data, because it is upgraded each time new trouble is found. (See page 471)
- The scan function is for filtering out the data that causes failure to mobile phones at the time of browsing web pages or receiving mail messages. Note that this function works only when the pattern data for each failure has been downloaded to your mobile phone and when the pattern data for each failure is found.
- The data contained in the pattern data varies depending on the mobile phone model. Therefore, note that we may stop distributing the pattern data to mobile phones that have been on the market for three years or more.

## Set Scanning Function <Set Scan>

If you set "Scan" to "Valid", data or a program can be automatically checked when you try to run it.

In addition, if you set "Message scan" to "Valid", a received SMS message can be automatically checked when you display it.

**1**  **Settings ▶ Lock/Security ▶ Scanning function**  
**▶ Set scan ▶ Select an item.**

**Scan.** . . . . . Sets whether to run the scanning function.

**Message scan** . . . . . Sets whether to run the scanning function when displaying an SMS message.

- While "Scan" is set to "Invalid", you cannot set "Message scan".

## 2 Valid or Invalid ▶ YES

- When the scan function is set, an alert is shown by five levels if data that might cause failure is detected. (See page 472)

### Information

- The scanning is not available for the SMS message which notifies you of receiving mopera mail or of incoming calls for Voice Mail Service.

## Update Pattern Data <Update>

**1**  **Settings ▶ Lock/Security ▶ Scanning function**  
**▶ Update ▶ YES ▶ YES**

- To cancel during i-mode connection, select "Cancel".

## 2 OK

- When pattern data update is not necessary, "Pattern definitions are up-to-date" is displayed. Use the pattern data as it is.

### Information

- When updating the pattern data, the proper information about your FOMA phone (model name, serial number, etc.) is automatically sent to the server (DOCOMO-managed server for the scanning function). We at DOCOMO never use the sent information for other purposes than for the scanning function.
- Set the date (year/month/date) for the FOMA phone correctly in advance.
- The pattern data is not updated in the following cases:
  - When the date/time is not set
  - During a call
  - Out of the service area
  - When the UIM is not inserted
  - During Lock All
  - While another function is working
  - When connecting to external devices such as personal computers
  - While Self Mode is activated
- If you cancel downloading midway, the data downloaded up to that point is deleted.

## Update Pattern Data Automatically <Set Auto-update>



You can set whether to update the pattern data inside your FOMA phone when the pattern data is created anew.

**1**  **Settings** ▶ **Lock/Security** ▶ **Scanning function**  
▶ **Set auto-update** ▶ **ON or OFF**

**2** **YES** ▶ **OK**

- When you select "ON" in step 1, the confirmation display appears telling that your mobile phone information is sent at auto-update.
- To cancel during i-mode connection, select "Cancel".

### Information

- When setting auto-update or updating automatically, the proper information about your FOMA phone (model name, serial number, etc.) is automatically sent to the server (DOCOMO-managed server for the scanning function). We at DOCOMO never use the sent information for other purposes than for the scanning function.
- When auto-update is completed, the notification icon of "  " (Update completed) appears on the Stand-by display. If it is failed, "  " (Pattern update failed) appears. Select "  " to display the update result.

## Displays for Scanning Result



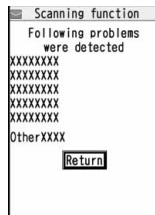

■ About the display for scanned problem elements

A warning display appears when problematic data is found. Select "Detail" from the warning display to bring up the name of the problem element.

- When six or more problem elements are found, the sixth and later problem element names are omitted.
- "Detail" might not appear depending on the detected problem element.

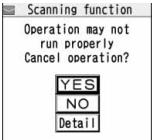

■ The displays for scanning result

Alert level 0	Alert level 1	Alert level 2
		
OK.....Continues the operation.	YES.....Stops and ends the operation. NO .....Continues the operation.	OK.....Stops and ends the operation.
Alert level 3	Alert level 4	
		
YES.....Deletes the data and ends the operation. NO.....Stops and ends the operation.	OK.....Deletes the data and ends the operation.	

- The alert displays for when displaying i-mode mail messages or SMS messages may differ from the ones above.

## Check Pattern Data Version <Version>

**1**  **Settings** ▶ **Lock/Security** ▶ **Scanning function**  
▶ **Version**

## Specifications

### ■ Handset

<b>Model</b>		FOMA P706iμ
<b>Dimensions (when closed)</b>		Height: 109 mm Width: 50 mm Depth: 9.8 mm
<b>Weight (with the battery pack attached)</b>		Approx. 100 g
<b>Continuous standby time</b>		Standstill: Approx. 440 hours In motion: Approx. 310 hours
<b>Continuous talk time</b>		Voice call: Approx. 150 minutes Videophone call: Approx. 100 minutes
<b>1Seg watching time</b>		Approx. 210 minutes (in ECO Mode: Approx. 260 minutes)
<b>Charging time</b>		AC adapter: Approx. 100 minutes DC adapter: Approx. 100 minutes
<b>LCD</b>	<b>Type</b>	TFT 262,144 colors
	<b>Size</b>	Approx. 3.0 inches
	<b>Number of pixels</b>	102,480 pixels (240 dots x 427 dots)
<b>Image pickup device</b>	<b>Type</b>	CMOS
	<b>Size</b>	1/4 inches
<b>Camera</b>	<b>Number of effective pixels</b>	Approx. 2,000,000 pixels
	<b>Number of recording pixels (maximum)</b>	Approx. 1,900,000 pixels
	<b>Zooming (digital)</b>	Approx. 9.3 times max.
<b>Recording</b>	<b>Number of recordable still images<sup>*1</sup></b>	Approx. 2,498 max. (default) Approx. 3,500 max. (when deletable pre-installed data files are deleted)
	<b>Number of still images for continuous shooting</b>	VGA: 4    CIF: 4    QVGA: 5 through 10 QCIF: 5 through 20    Sub-QCIF: 5 through 20
	<b>Still image file format</b>	JPEG
	<b>Moving image recording time</b>	Phone: Approx. 497 seconds <sup>*2</sup> microSD card (64MB): Approx. 137 minutes <sup>*3</sup>
	<b>Moving image file format</b>	Phone: MP4 microSD card: MP4, ASF <sup>*4</sup>

<b>Music playback</b>	<b>Continuous playback time<sup>*5</sup></b>	SD-Audio file (supports Play Background): Approx. 1,080 minutes <sup>*6</sup> Chaku-uta Full <sup>®</sup> music file (supports Play Background): Approx. 1,020 minutes <sup>*6</sup> i-motion movie (including Chaku-uta <sup>®</sup> music file): Approx. 720 minutes <sup>*6</sup> WMA file (supports Play Background): Approx. 960 minutes Music&Video Channel program (supports Play Background) Music: Approx. 1,020 minutes Video: Approx. 330 minutes
	<b>Memory capacity</b>	Chaku-uta <sup>®</sup> Chaku-uta Full <sup>®</sup> Approx. 111.6 Mbytes <sup>*7</sup>

<sup>\*1</sup>: Image size: Sub-QCIF (128 x 96), Image quality: Normal, File size: 10 Kbytes

<sup>\*2</sup>: The maximum recording time per moving image which can be saved to the FOMA phone with the following conditions:  
Image size: Sub-QCIF (128 x 96), File size setting: Mail restriction (L),  
Image quality: Normal, Type: Video + voice

<sup>\*3</sup>: The maximum recording time per moving image which can be saved to the microSD card with the following conditions:  
Image size: Sub-QCIF (128 x 96), File size setting: Long time,  
Image quality: Normal, Type: Video + voice

<sup>\*4</sup>: When "File size setting" is set to "Long time".

<sup>\*5</sup>: The continuous playback time is the estimated time that the FOMA phone can play back using the Flat-plug Stereo Earphone Set P01 (option) with the FOMA phone closed.

<sup>\*6</sup>: File format: AAC

<sup>\*7</sup>: Shares with still images, i-motion movies, melodies, PDF files, Music&Video Channel programs, Kisekae Tool files, ToruCa files, and i-oppli programs.

### ■ Battery pack

<b>Name of product</b>	Battery Pack P17
<b>Battery type</b>	Li-ion (lithium ion) battery
<b>Voltage</b>	3.7 V
<b>Capacity</b>	600 mAh

## Number of Savable/Storable/Protectable Items in FOMA Phone

Function		Number of savable/storable items <Number of protectable items>	Reference page
<b>Phonebook</b>		1,000*1	78
<b>1Seg</b>	TVlink	50	257
	Book program	100	259
	Timer recording	100	260
<b>Schedule</b>	Schedule	1,000	359
	Holiday	100	360
	Anniversary	100	360
<b>ToDo</b>		100	363
<b>Text memo</b>		20	369
<b>Mail</b> (total of SMS messages and i-mode mail messages)	Received mail	2,500 max. ※2, ※3, ※4 <2,500 max. ※2>	190
	Sent mail	1,000 max. ※2, ※4, ※5 <1,000 max. ※2>	190
	Draft mail※6	20 max. ※2	191
	User created folder (Inbox)	22	195
	User created folder (Outbox)	22	195
	<b>Area mail</b>	30	190
<b>Template</b>		100 max. ※2, ※7	181
<b>Message</b>	Message R	100 max. ※2 <50 max. ※2>	207
	Message F	100 max. ※2 <50 max. ※2>	207
<b>Bookmark (i-mode)</b>	Bookmark	100	156
	Bookmark folder	10 (incl. "Bookmark")	157
<b>Bookmark (Full Browser)</b>	Bookmark	100	156
	Bookmark folder	10 (incl. "Bookmark")	157
<b>Screen memo</b>	Screen memo	100 max. ※2 <50 max. ※2>	158
	Screen memo folder	10 (incl. "Screen memo")	158

Function		Number of savable/storable items <Number of protectable items>	Reference page
<b>Still image</b>		3,500 max. ※2, ※8, ※9	282
	User created folder	20	316
<b>Moving image/i-motion movie</b>		3,500 max. ※2, ※8, ※9	290
	User created folder	19	316
<b>Melody</b>		3,500 max. ※2, ※8, ※9	301
	User created folder	20	316
<b>Chara-den</b>		3※7	299
<b>PDF file</b>		3,500 max. ※2, ※8, ※9	323
<b>Music&amp;Video Channel</b>	Downloaded program	2	334
	Saved program	10 max. ※2, ※9	334
<b>Kisekae Tool</b>		3,500 max. ※2, ※8, ※9	304
<b>ToruCa</b>		495 max. ※2, ※9	240
	User created folder	20	242
<b>i-oppli</b>		100 max. ※2, ※9	220
	Mail-linked i-oppli	5	220

※1: Up to 50 Phonebook entries can be stored on the UIM.

※2: The number of savable, storable, or protectable items may decrease depending on the data volume.

※3: Includes mail in the "Chat" folder, "Trash box" folder and the i-oppli mail folder.

※4: In addition, a total of 20 received and sent SMS messages can be saved to the UIM. (See page 370)

※5: Includes mail in the "Chat" folder and the i-oppli mail folder.

※6: Can save unsent mail you are composing.

※7: Includes pre-installed data.

※8: Among pre-installed data, only the Deco-mail pictograms and Kisekae Tool files are included as the savable/storable items.

※9: Still images, i-motion movies, melodies, PDF files, music files, Music&Video Channel programs, Kisekae Tool files, ToruCa files, and i-oppli programs share the number of savable/storable items and memory space.



## SAR Certification Information and Other Information

### SAR Certification Information

This model phone FOMA P706iμ meets the MIC's\* technical regulation for exposure to radio waves.

The technical regulation established permitted levels of radio frequency energy, based on standards that were developed by independent scientific organizations through periodic and thorough evaluation of scientific studies. The regulation employs a unit of measurement known as the Specific Absorption Rate, or SAR. The SAR limit is 2 watts/kilogram (W/kg)\*\* averaged over ten grams of tissue. The limit includes a substantial safety margin designed to assure the safety of all persons, regardless of age and health. The value of the limit is equal to the international guidelines recommended by ICNIRP\*\*\*.

All phone models should be confirmed to comply with the regulation, before they are available for sale to the public. The highest SAR value for this model phone is 0.645 W/kg. It was taken by the Telecom Engineering Center (TELEC), a Registered Certification Agency on the Radio Law. The test for SAR was conducted in accordance with the MIC testing procedure using standard operating positions with the phone transmitting at its highest permitted power level in all tested frequency bands. While there may be differences between the SAR levels of various phones and at various positions, they all meet the MIC's technical regulation. Although the SAR is determined at the highest certified power level, the actual SAR of the phone during operation can be well below the maximum value.

For further information about SAR, please see the following web pages:

World Health Organization (WHO):	<a href="http://www.who.int/peh-ert/">http://www.who.int/peh-ert/</a>
ICNIRP:	<a href="http://www.icnirp.de/">http://www.icnirp.de/</a>
MIC:	<a href="http://www.tele.soumu.go.jp/e/e/e/body/index.htm">http://www.tele.soumu.go.jp/e/e/e/body/index.htm</a>
TELEC:	<a href="http://www.telec.or.jp/ENG/Index_e.htm">http://www.telec.or.jp/ENG/Index_e.htm</a>
NTT DOCOMO:	<a href="http://www.nttdocomo.co.jp/english/product/">http://www.nttdocomo.co.jp/english/product/</a>
Panasonic Mobile Communications Co., Ltd.:	<a href="http://panasonic.jp/mobile/">http://panasonic.jp/mobile/</a> (Japanese only)

\* Ministry of Internal Affairs and Communications

\*\* The technical regulation is provided in Article 14-2 of the Ministry Ordinance Regulating Radio Equipment.

\*\*\* International Commission on Non-Ionizing Radiation Protection

### European RF Exposure Information

This mobile phone complies with the EU requirements for exposure to radio waves. Your mobile phone is a radio transceiver, designed and manufactured not to exceed the SAR\* limits\*\* for exposure to radio-frequency (RF) energy, which SAR\* value, when tested for compliance against the standard was 0.654 W/kg.

**While there may be differences between the SAR\* levels of various phones and at various positions, they all meet\*\*\* the EU requirements for RF exposure.**

\* The exposure standard for mobile phones employs a unit of measurement known as the Specific Absorption Rate, or SAR.

\*\* The SAR limit for mobile phones used by the public is 2.0 watts/kilogram (W/kg) averaged over ten grams of tissue, recommended by The Council of the European Union. The limit incorporates a substantial margin of safety to give additional protection for the public and to account for any variations in measurements.

\*\*\* Tests for SAR have been conducted using standard operating positions with the phone transmitting at its highest certified power level in all tested frequency bands. Although the SAR is determined at the highest certified power level, the actual SAR level of the phone while operating can be well below the maximum value. This is because the phone is designed to operate at multiple power levels so as to use only the power required to reach the network. In general, the closer you are to a base station antenna, the lower the power output.

### Declaration of Conformity

**The product "FOMA P706iμ" is declared to conform with the essential requirements of European Union Directive 1999/5/EC Radio and Telecommunications Terminal Equipment Directive 3.1(a), 3.1(b) and 3.2. The Declaration of Conformity can be found on <http://panasonic.net/pmc/support/index.html>.**

※The European RTTE approval of this product is limited to the use of the P706iμ handset, Battery Pack and FOMA AC Adapter for Global use (100 to 240 V AC) only. Other accessories are not part of the approval.

## Important Safety Information

### AIRCRAFT

Switch off your wireless device when boarding an aircraft or whenever you are instructed to do so by airline staff. If your device offers a 'flight mode' or similar feature consult airline staff as to whether it can be used on board.

### DRIVING

Full attention should be given to driving at all times and local laws and regulations restricting the use of wireless devices while driving must be observed.

### HOSPITALS

Mobile phones should be switched off wherever you are requested to do so in hospitals, clinics or health care facilities. These requests are designed to prevent possible interference with sensitive medical equipment.

### PETROL STATIONS

Obey all posted signs with respect to the use of wireless devices or other radio equipment in locations with flammable material and chemicals. Switch off your wireless device whenever you are instructed to do so by authorized staff.

### INTERFERENCE

Care must be taken when using the phone in close proximity to personal medical devices, such as pacemakers and hearing aids.

#### Pacemakers

Pacemaker manufacturers recommend that a minimum separation of 15 cm be maintained between a mobile phone and a pacemaker to avoid potential interference with the pacemaker. To achieve this use the phone on the opposite ear to your pacemaker and do not carry it in a breast pocket.

#### Hearing Aids

Some digital wireless phones may interfere with some hearing aids. In the event of such interference, you may want to consult your hearing aid manufacturer to discuss alternatives.

#### For other Medical Devices:

Please consult your physician and the device manufacturer to determine if operation of your phone may interfere with the operation of your medical device.

## Export Administration Regulations

This product and its accessories might be covered by the Japan Export Administration Regulations ("Foreign Exchange and Foreign Trade Law" and its related laws). To export this product and its accessories, take the required measures on your responsibility and at your expenses. For details on the procedures, contact the Ministry of Economy, Trade and Industry.

# Index/Quick Manual















Index .....	478
Quick Manual .....	486



End a held call . . . . .	389	Channel setting. . . . .	249	Chara-den display. . . . .	299	Common phrase folder list . . . . .	381
Hold a call to make a new call . . . . .	389	Chapter info . . . . .	337	Chara-den list . . . . .	299	Common phrase list . . . . .	381, 447
Caller ID notification . . . . .	45	Character entry. . . . .	376	Chara-den player . . . . .	299	Common phrases . . . . .	381
Caller ID request . . . . .	392, 420	Bar code reader . . . . .	143	Chara-den recording display. . . . .	300	Common replay mode. . . . .	141
Camera . . . . .	27, 128	Candidate display . . . . .	380	Chara-den setup. . . . .	71	Communication setup files . . . . .	409
Number of storable still images . . . . .	132	Candidate display size . . . . .	380	Charge sound . . . . .	95	Connect to other devices . . . . .	408
Recordable time . . . . .	133	Change input mode. . . . .	380	Charging . . . . .	40	Connector terminal . . . . .	27
Specifications for moving image shooting . . . . .	132	Character set time. . . . .	380	Charging terminal . . . . .	27	Contents info. . . . .	276
Specifications for still image shooting . . . . .	131	Common phrases . . . . .	379	Chat group . . . . .	213	Continuous mode . . . . .	141
Camera menu . . . . .	135, 137	Copy . . . . .	381	Chat group address confirmation display. . . . .	213	Continuous scroll. . . . .	28
Caption (Video) . . . . .	298	Cut . . . . .	381	Chat group list. . . . .	213	Continuous shooting . . . . .	135
Caption (1Seg) . . . . .	263	Full pitch . . . . .	378	Chat group mail. . . . .	210	Cookie . . . . .	271
Capture screen. . . . .	325	Half pitch . . . . .	378	Chat mail display . . . . .	211	Cookie setting. . . . .	271
Category list . . . . .	306	Help. . . . .	380	Chat member . . . . .	210	Copy . . . . .	381
Certificate . . . . .	167	Input time . . . . .	379	Chat member list. . . . .	210	Copy from UIM . . . . .	370
Certificate host . . . . .	169	JUMP . . . . .	380	Chat setting. . . . .	213	Copy to microSD . . . . .	242, 244, 307, 309
Chaku-moji . . . . .	54	Kuten code . . . . .	379	Check box . . . . .	35, 152	Copy to phone. . . . .	242, 244, 308, 310
Chaku-motion . . . . .	92, 100	Learned words . . . . .	382	Check microSD. . . . .	313	Copy to UIM . . . . .	370
Chaku-uta full® music list . . . . .	342	Own dictionary . . . . .	382	Check new message . . . . .	187	Copyrights. . . . .	21, 127
Change action . . . . .	71, 300	Paste. . . . .	382	Check new messages. . . . .	386	Correct characters. . . . .	378
Change camera-mode . . . . .	140	Pictograph. . . . .	379	Check new SMS . . . . .	216	Count characters. . . . .	376
Change character code . . . . .	153	Predict. . . . .	378	Check same data . . . . .	246	Country code. . . . .	414
Change i-mode password . . . . .	155	Quote own data. . . . .	379	Check settings (Full browser) . . . . .	270	Country code setting . . . . .	59
Change PIN1 code. . . . .	116	Quote phonebook . . . . .	379	Check settings (i-apply) . . . . .	234	Cushy mark. . . . .	141, 288
Change PIN2 code. . . . .	116	Space . . . . .	379	Check settings (i-mode) . . . . .	165	Cut. . . . .	381
Change security code . . . . .	115	Symbols . . . . .	379	Check settings (Mail) . . . . .	205		
Change size . . . . .	288	Undo . . . . .	378	Check TV settings. . . . .	264		
Change to videophone call. . . . .	51, 63	2/NIKO-touch guide . . . . .	380	Clear max cost icon . . . . .	368		
Change to voice call. . . . .	51, 63	Character entry display. . . . .	376	Client authentication . . . . .	167		
Channel info . . . . .	253	Character input method . . . . .	376	Clock display. . . . .	112		
Channel list . . . . .	172, 249, 250	Mode1 (5-touch) . . . . .	376	Color label. . . . .	197		
Channel list display . . . . .	250	Mode2 (2-touch) . . . . .	383	Color mode set . . . . .	73, 140		
		Mode3 (NIKO-touch) . . . . .	384	Color theme setting. . . . .	102		
		Character size . . . . .	111	Command navigation key . . . . .	28		
		Character stamp. . . . .	288	Common phrase display . . . . .	381		
		Chara-den. . . . .	71, 299				



Data box . . . . .	280
Data broadcasting. . . . .	256
Data communication . . . . .	406
Data list . . . . .	306
Data security service. . . . .	125
Mail . . . . .	196
Phonebook . . . . .	90
Still image . . . . .	283

Data transfer (OBEX™ communication) . . . . .	406	Direct selection . . . . .	34	Early warning "Area Mail" settings . . . . .	209	Flat-plug earphone/microphone with switch. . . . .	371
Data while editing . . . . .	81, 378	Display . . . . .	26, 29	Earphone/microphone . . . . .	371	Flicker correction . . . . .	140
Day of week . . . . .	112	Display call/receive number . . . . .	110	Earpiece volume . . . . .	64	Focus. . . . .	73, 140
DC adapter . . . . .	41	Display during dialing . . . . .	49	ECO mode . . . . .	263	Folder info . . . . .	236
DCMX . . . . .	233	Display during videophone calls . . . . .	48	Edit  motion . . . . .	294	Folder list (Document file) . . . . .	327
Deco-mail . . . . .	178	Display for incoming calls . . . . .	63	Edit  motion display . . . . .	294	Folder list (i-motion) . . . . .	290
Deco-mail pictogram . . . . .	280	Display light . . . . .	264	Edit phonebook . . . . .	85	Folder list (Melody) . . . . .	301
Delete attached file . . . . .	184, 199	Display message R/F . . . . .	207	Edit picture . . . . .	286	Folder list (PDF) . . . . .	323
Delete cookies . . . . .	271	Display mode setting . . . . .	267	Edit picture display . . . . .	286	Folder list (Picture) . . . . .	282
Delete data . . . . .	85	Display phonebook image . . . . .	100	End stand-by display . . . . .	236	Folder list (SD other files) . . . . .	312
Desktop holder . . . . .	41	Display setting . . . . .	98	End stand-by info . . . . .	236	Folder list (Video) . . . . .	296
Desktop icon . . . . .	107, 108	Display size (Camera) . . . . .	141	English display . . . . .	43	FOMA antenna . . . . .	27
Desktop icon list . . . . .	110	Display size (Chara-den) . . . . .	300	English guidance . . . . .	393	FOMA communication environment check application . . . . .	233
Detailed channel list display . . . . .	250	Display size (i-motion) . . . . .	293	Enter URL . . . . .	155, 268	FOMA PC setup software . . . . .	409
Detailed chat group display . . . . .	213	Display size (PC movie) . . . . .	277	Equalizer (i-motion) . . . . .	293	Font . . . . .	110
Detailed data display . . . . .	306	Display size (Picture) . . . . .	286	Equalizer (MUSIC player) . . . . .	348	Forward specified calls to specified destination . . . . .	391
Detailed dialed call display . . . . .	52	Display SMS report . . . . .	199	Equalizer (Music&Video channel) . . . . .	337	Forward specified calls to voice mail center. . . . .	388
Detailed display . . . . .	136	Display software info . . . . .	221	Equalizer (Video) . . . . .	263	Forwarding guidance . . . . .	390
Detailed kisekae tool display . . . . .	304	DoCoMo certificate . . . . .	167	Equalizer (1Seg) . . . . .	263	Forwarding image . . . . .	321
Detailed mail group display . . . . .	203	DoCoMo keitai datalink . . . . .	410	Error messages . . . . .	454	Frame . . . . .	268, 287
Detailed message R/F display . . . . .	207	Document display settings . . . . .	327	Export administration regulations . . . . .	476	Full browser . . . . .	266
Detailed phonebook display . . . . .	85	Document info . . . . .	324, 328	<hr/>   <b>F</b>  		Full browser display . . . . .	266
Detailed received call display . . . . .	53	Document list . . . . .	327	Feel * Mail . . . . .	104	Full browser settings . . . . .	269
Detailed received mail display . . . . .	190, 192	Document viewer . . . . .	327	FeliCa mark . . . . .	27, 239, 321	Fullsong ring tone . . . . .	346
Detailed redial display . . . . .	52	Download . . . . .	160	File info . . . . .	304, 312, 328	Function list . . . . .	422
Detailed schedule display . . . . .	361	Download dictionary . . . . .	383	File property . . . . .	297, 299	Function menu . . . . .	34
Detailed screen memo display . . . . .	158	Download remain . . . . .	325	File restriction . . . . .	142, 284	<hr/>   <b>G</b>  	
Detailed sent mail display . . . . .	191, 193	DPOF setting . . . . .	329	File size setting . . . . .	140	G guide program list remote-controller . . . . .	231
Detailed sent message . . . . .	55	Draft . . . . .	191	Finder display . . . . .	129, 135, 137	GPRS network . . . . .	412
Detailed template display . . . . .	181	Draft list . . . . .	191, 194	FirstPass center . . . . .	167	Group setting . . . . .	83
Detailed ToruCa file display . . . . .	243	DTMF tone off . . . . .	73	Flash . . . . .	152		
Dialed call list . . . . .	52	Dual network . . . . .	392				
Dialed calls . . . . .	52	<hr/>   <b>E</b>  					
Dictionary info . . . . .	383	Early warning "Area Mail" . . . . .	208				

GSM network . . . . .	412	Receive one data file . . . . .	322	☺ motion auto-play . . . . .	171	Japanese display . . . . .	43
Guide . . . . .	36	Send all data files . . . . .	322	☺ motion info . . . . .	291	◆◆◆ K ◆◆◆	
<hr/>							
◆◆◆ H ◆◆◆							
Hands-free . . . . .	61	Send one data file . . . . .	321	i-motion player . . . . .	290	Key guide . . . . .	73
Hands-free with videophone . . . . .	74	i-Channel . . . . .	171	Inbox . . . . .	190	Keypad dial lock . . . . .	119
Header/signature . . . . .	205	Icon (Camera) . . . . .	141	Inbox folder list . . . . .	190, 191	Keypad sound . . . . .	94
Headset switch to call . . . . .	372	Icon (Video) . . . . .	264	Inbox list . . . . .	190, 192	Kisekai tool . . . . .	103, 304
Headset usage setting . . . . .	95	Icon (1Seg) . . . . .	264	In-call ring tone . . . . .	62	Kisekai tool list . . . . .	304
History info . . . . .	276	Icon color . . . . .	100	In-car hands-free . . . . .	61	◆◆◆ L ◆◆◆	
Holding . . . . .	65	Icons . . . . .	31	Info . . . . .	182	Last URL . . . . .	154
Holding (during a call) . . . . .	65	iD setting application . . . . .	232	Info notice setting . . . . .	106	LCD AI . . . . .	102
Home URL . . . . .	270	IDD prefix setting . . . . .	59	Infrared data exchange . . . . .	317	Learned words . . . . .	382
Host selection . . . . .	166	Illumination . . . . .	105, 106	Receive all data files . . . . .	320	Light sensor . . . . .	26, 101
<hr/>							
◆◆◆ I ◆◆◆							
i-oppli . . . . .	220	Image . . . . .	282	Receive one or multiple data files . . . . .	319	Line feed . . . . .	378
Automatic start . . . . .	234	Image quality . . . . .	102, 140	Send all data files . . . . .	320	Links with AV equipment . . . . .	452
Download . . . . .	220	Image quality (Video) . . . . .	263	Send one or multiple data files . . . . .	319	List of characters assigned to keys (NIKO-touch input method) . . . . .	441
Power saver . . . . .	224	Image quality (1Seg) . . . . .	263	Infrared data port . . . . .	27	List of characters assigned to keys (2-touch input method) . . . . .	440
Run . . . . .	221	Image size . . . . .	140	Infrared remote-controller . . . . .	321	List of characters assigned to keys (5-touch input method) . . . . .	439
Software info . . . . .	223	Image stabilizer . . . . .	141	Initial setting . . . . .	44	List setting (Mail) . . . . .	197
Start up . . . . .	221	☺ menu . . . . .	150	Initialize . . . . .	373	Listening (i-motion) . . . . .	293
Upgrade . . . . .	223	☺ menu in English . . . . .	151	Intellectual property rights . . . . .	21	Listening (MUSIC player) . . . . .	348
☺ oppli(microSD) . . . . .	236	i-mode . . . . .	150	International call access code . . . . .	414	Listening (Music&Video channel) . . . . .	337
i-oppli banking . . . . .	231	i-mode (Chaku-uta full <sup>®</sup> ) folder list . . . . .	342	International calls . . . . .	58	Listening (PC movie) . . . . .	277
i-oppli mail . . . . .	221	i-mode mail . . . . .	174	International dial . . . . .	416	Listening (Video) . . . . .	263
☺ oppli settings . . . . .	234	Compose . . . . .	174	(International roaming) . . . . .	416	Listening (1Seg) . . . . .	263
i-oppli stand-by display . . . . .	98, 235	Forward . . . . .	188	International dial assist . . . . .	59	Listing (i-motion) . . . . .	292
i-oppli to function . . . . .	164	Receive . . . . .	185	International prefix number for the universal number . . . . .	415	Listing (Kisekai tool) . . . . .	304
IC card content . . . . .	239	Reply . . . . .	187	International roaming . . . . .	412	Listing (PC movie) . . . . .	276
IC card lock . . . . .	246	Reply with quote . . . . .	187	International videophone call . . . . .	58	Listing (PDF) . . . . .	324
IC lock (power-off) . . . . .	246	Save . . . . .	175	Internet . . . . .	155	Listing (Video) . . . . .	298
iC transfer service . . . . .	238	Send . . . . .	174	ISP connection communication . . . . .	166	Lock all . . . . .	116
IC transmission . . . . .	321	i-mode menu . . . . .	150	◆◆◆ J ◆◆◆			
Receive all data files . . . . .	322	i-mode password . . . . .	114	JAN code . . . . .	143		
		i-mode settings . . . . .	165				
		i-mode trouble diagnosis site . . . . .	464				
		i-motion . . . . .	170				







◆◆◆ P ◆◆◆	
Packet communication	406
Page info	269
Page info on/off	325
Page layout	325
Palette	179
Passwords	114
Paste	382
Pause dial	57
PC mode	267
PC movie	272
PC movie auto-play	270
PC movie folder list	274
PC movie list	274
PC movie player	274
PC movie type selection display	274
PDF	323
PDF file list	323
PDF viewer	323
Personal data lock	118
Personal information	365
Phone mode	267
Phone to function	164
Phonebook	78
Phonebook image sending	90
Phonebook list	84
Photo auto display	205
Photo mode	135, 140
Photo-sending	184
Pictograph list	445
Picture	284
Picture info	283
Picture viewer	282
PIN1 code	114
PIN1 code entry set	115

PIN2 code	114
Play background	252, 334, 338, 343, 473
Play/erase messages	70
Play/erase videophone messages	70
Play mode setting (MUSIC player)	345
Play mode setting (Music&Video channel)	336
Played history list	276
Player menu display	341
Playing back record messages	70
Playlist (i-motion)	294
Play back playlist	294
Store playlist	294
Playlist (Melody)	301
Edit playlist	316
Play back playlist	301
Playlist (MUSIC player)	348
Create playlist	349
Play back playlist	349
Playlist list (i-motion)	294
Playlist list (MUSIC player)	349
PLMN setting	417
Point ring tone	346
Portrait rights	21, 127
Position memory (i-motion)	291
Position memory	293
Position memory (PC movie)	275
Position memory	276, 277
Position memory (Video)	297
Position memory	298
Position to play	93
Positioning	284
Post view display	135, 136, 138

Power on/off	43
Power saver mode	101
Prediction conversion at reply	204
Prefer Chaku-moji	56
Preferred tone	234
Prefix setting	60
Preparation flow for data communication	409
Preparation flow for data transfer (OBEX™ communication)	408
Priority	260
Priority order	
Alarm	261, 358
Answer message	69
Auto-sort	202
Call receiving image	100
Illumination	106
Nuisance call prevention	126
Ring tone	93
Substitute image	71, 72
Vibrator	94
Private menu	364
Private menu list	364
Private menu setting	364
Program folder list	334
Program guide i-appli	255
Program info	253, 336
Program list	334
Protect on (Mail)	196
Protect on (MessageR/F)	207
Protect on (Screen memo)	159
Public mode (Drive mode)	66
Public mode (Power off)	67
PUK (PIN unblock code)	115
Pull down menu	152

◆◆◆ Q ◆◆◆	
QR code	143
Quality alarm	95
Quick manual	486
Quick record message	69
Quick silent	64
Quotation marks	205

◆◆◆ R ◆◆◆	
Radio button	152
Radio waves reception level	29
Rakuoku exhibition application 2	230
Read aloud output	355
Read aloud settings	354
Read aloud speed	355
Read aloud valid setting	355
Read aloud volume	355
Reading aloud	354
Reason for no caller ID	123
Receive mail/call at open	101
Receive option	186
Receive option setting	186
Receive ToruCa	246
Received address	200
Received address list	200
Received call list	53
Received calls	52
Receiving a call	62
Receiving a call (International roaming)	416
Receiving a videophone call	62
Receiving a videophone call (International roaming)	416
Receiving display (Mail)	205
Receiving display (ToruCa)	246

Reception result display ..... 185, 208, 215	Reset channel setting .....264	SD-Audio ..... 340	Set as stand-by (Camera) ..... 139
Recharge battery display ..... 42	Reset last URL .....154, 270	SD other file list ..... 312	Set auto-update (Scanning function) ..... 472
Recognition mode .....148	Reset learned words .....382	SD-other files ..... 312	Set auto-update (Software update)
Recommend channel mail ..... 254	Reset settings .....264, 373	SD-PIM ..... 306	..... 466
Reconnect signal ..... 60	Reset storage area .....264	Search by i-mode ..... 163	Set check new message ..... 204
Record Chara-den .....300	Reset total cost&duration .....368	Search phonebook ..... 83	Set connection timeout ..... 166
Record display set .....120	Reset TV settings .....264	Search phonebook display ..... 83	Set display ..... 137, 283
Record message list .....70	Restrict dialing .....122	Secret code ..... 87	Set hold tone ..... 66
Record message setting ..... 68	Restrictions .....122	Secret data only ..... 120	Set  appli to ..... 223
Record still images .....258	Retouch .....288	Secret mail display ..... 121	Set image display ..... 165, 270
Record video ..... 258	Reversi .....225	Secret mode ..... 120	Set  motion ..... 291
Record voice memo .....366	Ring time .....124	Security error ..... 223	Set in-call arrival act ..... 394
Record when low battery .....263	Ring volume ..... 65	Security scan function (Scanning function) ..... 471	Set roaming guidance ..... 418
Recorded file restriction .....300	Roaming guidance .....419	Security settings ..... 113, 125	Set scan ..... 471
Recording result .....262	Rotate .....288	Select area ..... 250	Set time ..... 44
Redial ..... 52		Select image ..... 74, 75	Setting when folded ..... 64
Redial list .....52	"S" icons ..... 65	Select language ..... 43	Setting when opened ..... 64
Referer .....271	SAR .....475	Select ring tone ..... 92	Shot with frame ..... 141
Referer setting ..... 271	Save an i-motion movie .....170	Select storage ..... 243, 276, 316, 345	Shot interval .....141
Reject unknown .....124	Scanned code result display .....144	Selecting multiple items ..... 35	Shot number ..... 141
Reject videophone .....125	Scanned text confirmation display ..... 147	Self mode ..... 117	Shutter sound ..... 140
Related equipment ..... 452	Scanned text result display .....147	Send DTMF tone ..... 73	Side keys guard .....120
Releasing PIN lock .....116	Scanning code display .....143	Sent address ..... 200	Signature ..... 205
Reload .....153, 268	Scanning function .....471	Sent address list ..... 200	Simple menu ..... 35
Reload contents .....254	Scanning result .....472	Sent/received phonebook data list ..... 90	Site display for the FirstPass center ..... 168
Remaster (i-motion) .....293	Scanning text display .....146	Serial number of mobile phones/UIMs ..... 153	Slideshow ..... 284
Remaster (MUSIC player) .....347	Schedule .....359	Service numbers ..... 393	Smiley ..... 378, 447
Remaster (Music&Video channel) .....337	Schedule list .....360	Services available overseas ..... 412	SMS ..... 214
Remaster (PC movie) .....277	Screen memo .....158	Services available with FOMA phones ..... 451	Compose ..... 214
Remaster (Video) .....263	Screen memo folder list .....158	Set as ring tone (Chaku-uta full <sup>®</sup> ) ..... 346	Forward ..... 188
Remaster (1Seg) .....263	Screen memo list .....158	Set as ring tone (Melody) ..... 302	Receive ..... 215
Remote control .....395, 419	Script setting .....270		Reply ..... 187
Remote control number .....251	Scroll .....35, 165, 204, 269		Save ..... 215
Reserve update .....469	Scroll selection .....31		Send ..... 214

SMS center selection . . . . .	217	Summer time . . . . .	45	Troubleshooting . . . . .	453	Video player . . . . .	296	
SMS composition display . . . . .	214	Super silent . . . . .	98	Tune service . . . . .	254	Videophone record message list . . . . .	70	
SMS input character . . . . .	217	Switch audio data . . . . .	253	TV sound while closed . . . . .	263	Videophone settings . . . . .	73	
SMS report request . . . . .	216	Switch display . . . . .	253	TVlink . . . . .	257	Videophone while packet . . . . .	75	
SMS settings . . . . .	216	Switch image display positions . . . . .	72	TVlink list . . . . .	257	View blind . . . . .	102	
SMS validity period . . . . .	216	Switch images to be sent . . . . .	72	Type list . . . . .	341	Viewer display . . . . .	251	
Software for playing back moving images . . . . .	452	Switch TV/data BC . . . . .	253	<b>◆◆◆ U ◆◆◆</b>			Visual preference . . . . .	74
Software info . . . . .	223	Symbol candidate list . . . . .	444	UIM (FOMA card) . . . . .	37	Voice announcement . . . . .	94	
Software list . . . . .	221	Symbol list . . . . .	442	Insert/remove . . . . .	37	Voice call auto redial . . . . .	75	
Software setting . . . . .	223	<b>◆◆◆ T ◆◆◆</b>			Security function (Restriction function) . . . . .	Voice dial . . . . .	88	
Change melody/image . . . . .	223	Template . . . . .	181	Types . . . . .	38	Voice dial setting . . . . .	88	
Icon info . . . . .	223	Template list . . . . .	181	UIM operation . . . . .	370	Voice earphone dial . . . . .	89	
Network set . . . . .	223	Terminal security code . . . . .	114	UIM setting . . . . .	115	Voice mail . . . . .	386, 419	
Program guide key . . . . .	223	Text box . . . . .	152	Update (Pattern data) . . . . .	471	Voice memo . . . . .	366	
See phonebook/history . . . . .	223	Text memo . . . . .	369	Update now . . . . .	469	Voice memo during a call . . . . .	366	
Stand-by net . . . . .	236	Text memo info . . . . .	369	Update ToruCa . . . . .	244	Voice recorder . . . . .	322	
Stand-by set . . . . .	235	Text reader . . . . .	146	Upload . . . . .	269	Voice recorder recording display . . . . .	322	
View ToruCa . . . . .	223	Text reader list . . . . .	147	URL history . . . . .	155	Voice recorder saving pre-check display . . . . .	323	
Software update . . . . .	465	Timer lock on at close . . . . .	119	URL history list . . . . .	155	Voice settings . . . . .	89	
Software update display . . . . .	468	Timer recording . . . . .	260	USB mode setting . . . . .	313	<b>◆◆◆ W ◆◆◆</b>		
Sound effect setting . . . . .	165, 264	Title name . . . . .	284	Use phone information . . . . .	165	Wake-up display . . . . .	99	
Speakers . . . . .	27	ToDo . . . . .	363	User authentication . . . . .	407	Warranty . . . . .	463	
Specific absorption rate . . . . .	475	ToruCa . . . . .	240	User certificate . . . . .	167	Web mail . . . . .	217	
Specifications . . . . .	473	ToruCa file list . . . . .	243	Request issue/download . . . . .	168	Web to function . . . . .	164	
SSL certificate . . . . .	167	ToruCa folder list . . . . .	241	Request revocation . . . . .	169	White balance . . . . .	73, 140	
Stand-by display . . . . .	43	ToruCa settings . . . . .	246	User settings . . . . .	263	Window open guard . . . . .	270	
Stand-by set (i-oppli) . . . . .	235	ToruCa viewer . . . . .	241	Uta-hodai . . . . .	338	WMA file . . . . .	339	
Status icon . . . . .	107	Total calls . . . . .	367	<b>◆◆◆ V ◆◆◆</b>			WMA list . . . . .	342
Status in the area . . . . .	418	Total calls duration . . . . .	367	"V" icons . . . . .	93	WORLD CALL . . . . .	58	
Still image . . . . .	282	Trace info . . . . .	223	Version . . . . .	472	World time watch . . . . .	45	
Still image list . . . . .	282	Trademarks . . . . .	21	Vibrator . . . . .	93	WORLD WING . . . . .	412	
Still image shoot . . . . .	135	Trim away . . . . .	288	Video . . . . .	296	<b>◆◆◆ Z ◆◆◆</b>		
Store in . . . . .	140, 323	Trim for mail . . . . .	295	Video list . . . . .	296	Zoom . . . . .	73, 139, 270	
Sub-address setting . . . . .	60	Trim for picture . . . . .	295					
Substitute image . . . . .	48, 71, 74	Trim  motion . . . . .	295					

Zoom in . . . . .	324, 328
Zoom out . . . . .	324, 328

## ◆◆◆ Numerics ◆◆◆

1Seg . . . . .	248
1Seg antenna . . . . .	27
184 . . . . .	56
186 . . . . .	56
2in1 . . . . .	396
2in1 setting menu display . . . . .	396
2-touch dial . . . . .	88
3G network . . . . .	412
3GPP . . . . .	48
3G-324M . . . . .	48
64K data communication . . . . .	406

## Quick Manual

### How to Use Quick Manual

Cut out Quick Manual interleaved into this manual along the cutout line, and then fold it as shown below:

Take Quick Manual “For Overseas Use” with you for using an international roaming service (WORLD WING) overseas.

#### ■ How to cut

Cut out Quick Manual along the cutout line. You can cut it out by placing a ruler on the cutout line.

- Be careful not to cut yourself when using scissors.

#### ■ How to fold

Fold Quick Manual along the dotted line so that the cover faces upwards as illustrated below.

- Put the first sheet on the second and other sheets in the order, and fold them together.

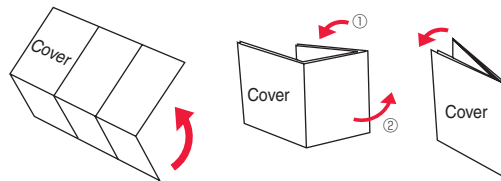

**General inquiries <DOCOMO Information Center>**

(In English)

0120-005-250 (toll free)

\* Can be called from mobile phones and PHSS.

(In Japanese only)

**(No prefix) 151 (toll free)**

\* Can be called only from DOCOMO mobile phones.

**Repairs**

(In Japanese only)

**(No prefix) 113 (toll free)**

\* Can be called only from DOCOMO mobile phones.

(In Japanese only)

0120-800-000 (toll free)

\* Can be called from mobile phones and PHSS.

• Please confirm the phone number before you dial.

• For various procedures, repairs, and maintenance, dial the phone numbers listed above, or visit the DOCOMO web page or i-mode site to find your nearest DOCOMO shop, and then inquire about them.

DOCOMO web page <http://www.nttdocomo.co.jp/>  
i-mode site | Menu ▶ お知らせ(Notice) ▶ ドコモショップ(DOCOMO Shop)  
(In Japanese only)

**Store from Redial, Dialed Calls, or Received Calls**

**■ Adding Data to the FOMA phone**

Bring up the redial item, dialed call record, or received call record → → Add to phonebook

→ Phone → Add → Select a search method

→ Search the Phonebook

→ Select a destination Phonebook entry →

→ → YES

**Edit Phonebook Entries**

Bring up the detailed Phonebook display

→ → Select an item to be edited

→ Edit the contents → → YES

**Storing in Phonebook (FOMA Phone)**

(for at least one second) → Phone

Enter a name.

→ Edit a reading.

Group → Select a group.

Phone number → Enter a phone number  
→ Select an icon. (up to four numbers)

Mail address → Enter a mail address  
→ Select an icon. (up to three addresses)

Address → Enter a zip code  
→ Enter a postal address.

Birthday → Enter a birthday → ON or OFF

1

**Character Entry**

**■ Character Entry Mode**

abc... Alphabets

123... Numerals

漢... Kanji/Hiragana

加... Katakana

**■ Selecting Character Input Method**

→ Settings → Other settings

→ Character input method → Input mode →

Put a check mark for Mode 1 (5-touch)

Put a check mark for Mode 2 (2-touch)

Put a check mark for Mode 3 (NIKO-touch)

→ → Select a mode you use with priority.

**■ Entering “ ” and “ ° ”**

Enter a character → Press several times.

4

Memo → Enter a memo.

Image → Select an item.

Shoot image... Store a still image from Data Box.

Shoot image... Store a still image shot by the camera.

Memory No.

→ Enter a three-digit memory number →

2

**■ Entering “、” and “。”**

Press several times.

**■ Switching “Alphabet” (abc), “Numerals” (123),**

“Kanji/Hiragana” (漢), and “Katakana” (加)

Press several times.

**■ Entering Pictographs**

→ Pictograph/symbols → Pictograph





→ Select a pictograph.

**■ Entering Symbols**

→ Pictograph/symbols → Symbols





→ Select a symbol.

5

- Line Feed  
Press .
- Entering a Space  
→Pictograph/symbols→Space
- Deleting Characters  
Use  to move the cursor→
- Switching to Uppercase/Lowercase  
Enter a character→













6

## 1Seg

- Auto Channel Setting  
→1Seg→Channel setting  
→Auto channel setting→YES→YES  
→Enter a title.
- Select Area  
→1Seg→Channel setting→Select area  
→Select an area→Select a prefecture→YES
- Channel List  
→1Seg→Channel list→Select a channel list.
- Watching a 1Seg Program  
 (for at least one second)



9

## Enter “タダの菓子” in a Text Memo

- Bringing up the Character Entry (Edit) display  
→Stationery→Text memo  
→Select <Not recorded>→Press  a few times to switch to Kanji/Hiragana input mode.
- Entering Hiragana characters <Mode 1>  
た→Press  once and  once.  
だ→Press  once and  once.  
の→Press  five times.  
か→Press  once.  
し→Press  twice.
- Converting the Characters  
Use  to move the cursor to “の”→  
→Use  to highlight “タダの” and press   
→Fix the rest of characters in the same way.















7

## Music Playback

- Playback by Music&Video Channel  
→MUSIC→Music&Video Channel  
→Select a program.  
or  
→Data box→Music&Video Channel  
→Downloaded program or Saved program  
→Select a program.
- Playback by MUSIC Player  
→MUSIC→MUSIC Player→All tracks  
→Select a music file.







10

## Camera

- Shooting a Still Image  
→→
- Continuous Shooting  
→→→  
→Select a still image and press →
- ※This is the procedure to select and save one still image for continuous shooting.
- Shooting a Moving Image  
→→→→

8

## Making and Receiving a Videophone Call

- Making a Videophone Call  
Enter the other party's phone number→  
→Press  to end the call after talking.
- Receiving a Videophone Call  
The ring tone sounds and the Call/Charging indicator flickers→ or   
→Press  to end the call after talking.  
The substitute image is sent to the other party.
- Switching to Hands-free  
During a call, dialing, or connecting→

11

## i-mode Mail

### Compose and Send i-mode Mail

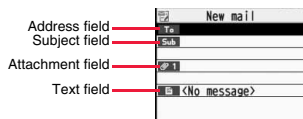

Select the address field→Select an entering method  
→Enter or select an address.

Select the subject field→Enter a subject.

Select the text field→Enter text.

Send a mail message by pressing

→After sending, press

12

## Attach Files

■ Picture/Melody/ motion/ToruCa/PDF/  
Phonebook/Schedule/ToDo/Bookmark/  
Document/Other

Bring up the Message Composition display

→Select the attachment field

→Select a file type to be attached

→Select a folder→Select a file.

Selecting methods differ depending on the file.

13

## Receive i-mode Mail

“ (white)” blinks

→The Reception Result display appears

→Select “Mail”

→Select an i-mode mail message to be displayed.

## Check New Message

(for at least one second)

14

## Other Mail Functions

### ■ Replying

Select or bring up a mail message to be replied

→→Reply/forward

→Reply, or Reply with quote

→Select the text field→Enter text→

→After sending, press

### ■ Forwarding

Select or bring up a mail message to be forwarded→→Reply/forward→Forward

→Select the address field

→Select an entering method

→Enter or select an address→

→After sending, press

15

## Function List

	Menu	Function name
Mail		Inbox
		Outbox
		Draft
		Compose message
		Template
		Web mail
		Check new message
		Compose SMS
		Check new SMS
		Chat mail
		Receive option
		Mail settings
		SMS settings
		Area mail settings
i-mode	Menu	Bookmark

16

i-mode	Screen memo
	Last URL
	Go to location
	Message R/F
	i-Channel
i-oppli	Check new message
	Operate certificate
	i-mode settings
	Full Browser
	Software list(phone)
Settings	oppli(microSD)
	oppli info
	oppli settings
	<b>Sound</b>
	13 Select ring tone
	50 Ring volume
	30 Keypad sound
64 Position to play	
51 Headset usage setting	
68 Mail/Msg. ring time	

17

<b>Display</b>	
56	Display setting
70	Backlight
	View blind
86	Color theme setting
57	Menu icon setting
52	Private menu setting
63	Desktop icon
66	Font
	Character size
15	Select language
	Recv.mail/call at open
	Image quality
	LCD AI
36	Icons

18

<b>Illumination</b>	
	All illum. setting
89	Illumination
	Illumination in talk
	Miss/unread illum.
	Music&Video ch illum.
	Illum. when folded
	Hourly illumination
	MUSIC illumination
	IC card illumination
	Side key illumination
	Check settings
<b>Kisekae</b>	
<b>Lock/Security</b>	
	Self mode
	Lock all
	Personal data lock
	IC card lock
	Timer lock ON at close
40	Secret mode

19

	41	Secret data only
		Keypad dial lock
		Reject unknown
	10	Call setting w/o ID
	29	Change security code
		UIM setting
		Scanning function
		IC lock (power-off)
<b>Call time/cost</b>		
	61	Call data
	60	Reset total cost&dura.
		Notice call cost
		CLR max cost icon
<b>Clock</b>		
	31	Set time
		World time watch
		Summer time
		Auto power ON/OFF
		Alarm setting

20

<b>Incoming call</b>	
54	Vibrator
20	Manner mode set
58	Answer setting
	Setting when opened
	Record display set
	Disp. PH-book image
	Disp. call/receive No.
90	Ring time
65	Info notice setting
	V-phone while packet
94	Auto answer setting
<b>Talk</b>	
	Volume
18	Setting when folded
	Set hold tone
76	Noise reduction
75	Quality alarm
77	Reconnect signal

21

<b>Videophone</b>	
	Visual preference
	Select image
	Hands-free w/ V. phone
	Voice call auto redial
	Notify switchable mode
	Reject videophone
<b>Feel * Mail</b>	
	Disp. /play new one
	Disp. /play in history
<b>Network setting</b>	
	Prefix setting
	Int'l roaming
	Int'l dial assist
	Status in the area
<b>Melody Call setting</b>	

22

<b>Other settings</b>	
	Side keys guard
35	Character input method
	Battery
84	Pause dial
	Sub-address setting
	Headset switch to call
	Voice settings
	USB mode setting
23	Reset settings
	Initialize
	Software update

23

&lt;Cutout line&gt;



Data box	46	My picture MUSIC Music&Video Channel motion
	16	Melody My documents Kisekae Tool Chara-den PC Movie 1Seg Document viewer SD other files
LifeKit	79	Bar code reader Receive Ir data SD-PIM Camera Text reader
	55	Rec. msg/voice memo Voice recorder Data Security Service

24

1Seg	Activate 1Seg Program guide Book program Timer recording Recording result TVlink Channel list Channel setting User settings
Osaifu-Keitai	IC card content DCMX ToruCa IC card lock set. Settings Search by i-mode

#### Public Mode (Drive Mode)

(for at least one second)

#### Manner Mode

During standby/During a call  
→ (for at least one second)

27

Service	17	Caller ID notification Voice mail Call waiting Call forwarding Nuis. call blocking Caller ID request 2in1 setting Multi number Arrival call act Set in-call arrival act Remote control Dual network English guidance Set Roaming guidance Additional service Service numbers OFFICEED Chaku-moji
---------	----	---

25

## Network Services

### Voice Mail Service

#### Activating

→ Service → Voice mail → Activate → YES  
→ YES → Enter a ring time (seconds).

#### Deactivating

→ Service → Voice mail → Deactivate → YES

#### Playing Back Messages

→ Service → Voice mail → Play messages  
→ YES → Operate following the voice guidance.

28

Phonebook		Add to phonebook Search phonebook UIM operation
	24	Dialed/recv. calls
	0	Own number Group setting Restrictions
	26	Phonebook settings No. of phonebook
Stationary	44	Alarm
	45	Schedule
	95	ToDo
	42	Text memo
	85	Calculator Guide
	38	Common phrase/dic.
MUSIC		MUSIC Player Music&Video Channel

26

## Call Waiting Service

#### Activating

→ Service → Call waiting → Activate → YES

#### Deactivating

→ Service → Call waiting → Deactivate → YES

#### Answering an Incoming Call during a Call

A call comes in during a call →

Each time you press , you can switch the parties you talk with.

29

## Call Forwarding Service

### ■ Activating

-  → Service → Call forwarding → Activate
- Register fwd number → Enter the phone number of the forwarding destination
- Set ring time → Enter a ring time (seconds)
- Activate → YES

### ■ Deactivating

-  → Service → Call forwarding → Deactivate
- YES

30

 (white): i-mode mail is held at the i-mode Center.

 (white): Messages R/F are held at the i-mode Center.

 : i-mode mail is held at the i-mode Center (While Receive Option Setting is set to "ON").

 : During Lock All

 : During Personal Data Lock

 : During Keypad Dial Lock

 : During Secret Mode or Secret Data Only

 : During IC Card Lock

 : While Timer Lock ON At Close is set

33

## Services Available with FOMA Phone

Available service	Phone number
Directory assistance service (Charges apply: guidance fee + call fee) ※ Listed phone numbers only can be given.	(No prefix) 104
Telegrams (Telegram charges apply)	(No prefix) 115
Time check (Charges apply)	(No prefix) 117
Weather forecast (Charges apply)	City code of the desired area + 177
Emergency calls to police	(No prefix) 110
Emergency calls to fire station and ambulance	(No prefix) 119
Emergency calls for accidents at sea	(No prefix) 118
Disaster messaging service (Charges apply)	(No prefix) 171
Collect calls (Charges apply: guidance fee + call fee)	(No prefix) 106

31

 : While Vibrator is set to other than "OFF"  
(See page 21)

 : While Ring Volume is set to "Silent" or Mail/Msg. Ring Time is set to "OFF"

 : During Manner Mode (See page 27)

 : During Public Mode (Drive Mode)  
(See page 27)

 : While Side Keys Guard is set to "ON"  
(See page 23)

34

## Major Icons

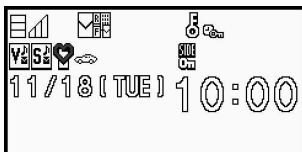

 : Battery level (estimate)

 : Radio waves reception level (estimate)

 : During Self Mode

 (white): Unread i-mode mail or SMS messages exist.

 (white): Unread Messages R/F exist

32

### <Emergency Contact Number for Loss Etc.>

#### Omakase Lock

※ Omakase Lock is a pay service. However, you are not charged if you apply for this service at the same time as applying for the suspension of the use or during the suspension.

Setting/Releasing Omakase Lock

 0120-524-360

Business hours: 24 hours

#### Other Emergency Calls

< Phone number : \_\_\_\_\_ >

< Phone number : \_\_\_\_\_ >

< Phone number : \_\_\_\_\_ >

● Please confirm the phone number before you dial.

35

# NTT docomo FOMA P706ip Quick Manual "For Overseas Use"

## Loss or theft of FOMA terminal or payment of cumulative cost overseas

<DOCOMO Information Center> (available 24 hours a day)

● From a DOCOMO mobile phone

International call access code **-81-3-5366-3114\***

for the country you stay (Table 1) (toll free)

\* You are charged a call fee to Japan when calling from a landline phone, etc.

※ If you use P706ip, you should dial the number +81-3-5366-3114 (to enter "+", press and hold the "0" key for at least one second).

● From a landline phone

<Universal number>

International prefix number for **-800-0120-0151\***  
the universal number (Table 2)

\* You might be charged a domestic call fee according to the call rate for the country you stay.

※ See page 16 and page 20 for international call access codes for major countries (Table 1) and international prefix numbers for the universal number (Table 2).

## Failures encountered overseas

<Network Technical Operation Center> (available 24 hours a day)

● From a DOCOMO mobile phone

International call access code **-81-3-6718-1414\***  
for the country you stay (Table 1) (toll free)

\* You are charged a call fee to Japan when calling from a landline phone, etc.

※ If you use P706ip, you should dial the number +81-3-6718-1414 (to enter "+", press and hold the "0" key for at least one second).

● From a landline phone

<Universal number>

International prefix number for **-800-5931-8600\***  
the universal number (Table 2)

\* You might be charged a domestic call fee according to the call rate for the country you stay.

※ See page 16 and page 20 for international call access codes for major countries (Table 1) and international prefix numbers for the universal number (Table 2).

● If you lose your FOMA phone or have it stolen, immediately take the steps necessary for suspending the use of the FOMA phone.

● If the FOMA phone you purchased malfunctions, bring your FOMA phone to a repair counter specified by DOCOMO after you return to Japan.

## Preparing for Overseas Use

### Setting of i-mode

■ Setting in Japan

→ Menu → English → Options

→ International Settings

→ i-mode services Settings → Select "Yes"

→ Enter your i-mode password → Select

■ Setting Overseas

→ Menu → English → Options

→ International Settings

→ i-mode services Settings → Select "Yes"

→ Enter your i-mode password → Select

<Cutout lines>

## Remote Control

■ Setting in Japan

→ Service → Remote control → Activate  
→ YES

■ Setting Overseas

→ Settings → Network setting → Int'l roaming  
→ Remote control (Int.) → YES  
→ Operate following the voice guidance.

## Set Time

→ Settings → Clock → Set time  
→ Auto time adjust ON

## Services Available Overseas

■ Voice call

In the country you stay, you can use the phone number as used in Japan to make or take local calls, or to make international calls to Japan or to other countries.

■ Videophone call

You can make international videophone calls to users of the specified 3G mobile phone carriers overseas and FOMA users.

■ i-mode

■ i-mode mail

You can send/receive i-mode mail messages overseas by the same address as used in Japan.

■ SMS

■ i-Channel

■ Packet communication by connecting with a personal computer

● The 64K data communication is not available overseas.

## Setting a Search Method of Carrier

→ Settings → Network setting → Int'l roaming  
→ Network search mode → Select an item.

**Auto** . . . . . Automatically re-connect to another carrier. The setting is completed.

**Manual** . . . . . Connects manually to the listed carrier.

**Network re-search**

. . . . . . . . . . . When set to "Auto", automatically switches to an available carrier. The setting is completed. When set to "Manual", displays the list of carriers.

→ Select a carrier.

## Selecting a Carrier to Preferentially Connect to

- Settings → Network setting → Int'l roaming  
→ PLMN setting → → PLMN list select  
→ Select a carrier → → YES

## Displaying a Carrier Name on the Stand-by Display

- Settings → Network setting → Int'l roaming  
→ Operator name display  
→ Display ON or Display OFF

6

## Make a Call to a Phone in the Country You Stay

Enter a destination phone number →   
Press to make a videophone call.

- Making a Call Using Phonebook  
Bring up the detailed Phonebook display  
→ → "Original phone No."

## Make a Call to a Person Staying Overseas and Using WORLD WING

When you make a call to a person who is internationally roaming, make the call in the same way as to make international calls to Japan even if he/she is in the country you stay.

## Receive a Call

Press when a call comes in.  
(For videophone call, press )

9

## Display

The name of carrier you use is displayed.



## Setting after Returning to Japan

After you return to Japan, the FOMA network is automatically searched and connected.

- When you have set to switch networks manually  
 → Settings → Network setting → Int'l roaming  
→ Network search mode → Manual → DoCoMo

7

## Using Network Services

To use network services overseas, you need to set "Remote control" beforehand.

- Set Roaming Guidance
  - You need to set this function in Japan.  
 → Service → Set Roaming guidance
- Call Barring
  - This setting might not be available depending on the overseas carrier.  
 → Settings → Network setting → Int'l roaming  
→ Call barring
- Voice Mail (International)  
 → Settings → Network setting → Int'l roaming  
→ Voice mail (Int.)

10

## Making/Receiving a Call

### Make a Call to Outside the Country You Stay (Including Japan)

- Making an International Call to Japan Using Phonebook

Bring up the detailed Phonebook display

→ → Dial

Press to make an international videophone call.

- Making an International Call Using "+"

(for at least one second) → Enter  
"Country code - Area code (City code) -  
Destination phone number" →

Press to make an international videophone call.

Enter "81" as a country code when you make an international call to Japan.

When the area code (city code) begins with "0", enter it except for the "0". However, include "0" when making a call to some countries or regions such as Italy.

8

- Call Forwarding (International)

→ Settings → Network setting → Int'l roaming  
→ Call forwarding (Int.)

- Roaming Guidance (International)

→ Settings → Network setting → Int'l roaming  
→ Roaming guidance (Int.)

- Caller ID Request

→ Settings → Network setting → Int'l roaming  
→ Caller ID req. (Int.)

11

## Country Codes for Major Countries

Use the following country codes when you make international calls or when you set Int'l Dial Assist.

(As of June 2008)

Service area	Code
Australia	61
Belgium	32
Brazil	55
Canada	1
China	86
Czech Republic	420
Denmark	45
Finland	358
France	33

12

Service area	Code
Turkey	90
United Arab Emirates	971
United Kingdom	44
United States of America	1
Vietnam	84

- For the code for the countries other than listed in the table, or for details, refer to the DOCOMO Global Service web page.

15

Service area	Code
Germany	49
Greece	30
Hong Kong	852
Hungary	36
India	91
Indonesia	62
Ireland	353
Italy	39
Luxembourg	352
Macau	853
Malaysia	60
Monaco	377
Netherlands	31

13

## International Call Access Codes for Major Countries (Table 1)

(As of March 2008)

Service area	Access code
Australia	0011
Belgium	00
Brazil	0021/0014
Canada	011
China	00
Czech Republic	00
Denmark	00
Finland	00
France	00
Germany	00

16

Service area	Code
New Zealand	64
Norway	47
Philippines	63
Poland	48
Portugal	351
Russia	7
Singapore	65
South Korea	82
Spain	34
Sweden	46
Switzerland	41
Taiwan	886
Thailand	66

14

Service area	Access code
Greece	00
Hong Kong	001
Hungary	00
India	00
Indonesia	001
Ireland	00
Italy	00
Luxembourg	00
Macau	00
Malaysia	00
Monaco	00
Netherlands	00
New Zealand	00

17

Service area	Access code
Norway	00
Philippines	00
Poland	00
Portugal	00
Russia	810
Singapore	001
South Korea	001
Spain	00
Sweden	00
Switzerland	00
Taiwan	002
Thailand	001
Turkey	00

18

Service area	Access code
United Arab Emirates	00
United Kingdom	00
United States of America	011
Vietnam	00

19

## International Prefix Numbers for the Universal Number (Table 2)

(As of March 2008)

Service area	International prefix number
Argentina	00
Australia	0011
Austria	00
Belgium	00
Brazil	0021
Bulgaria	00
Canada	011
China	00
Colombia	009
Denmark	00

20

Service area	International prefix number
Finland	990
France	00
Germany	00
Hong Kong	001
Hungary	00
Ireland	00
Israel	014
Italy	00
Luxembourg	00
Malaysia	00
Netherlands	00
New Zealand	00
Norway	00

21

Service area	International prefix number
Peru	00
Philippines	00
Portugal	00
Singapore	001
South Africa	09
South Korea	001
Spain	00
Sweden	00
Switzerland	00
Taiwan	00
Thailand	001
United Kingdom	00
United States of America	011

22

## Inquiries

For lost, stolen, and cost settlement, or malfunction of your FOMA phone overseas, refer to “Loss or theft of FOMA terminal or payment of cumulative cost overseas” on cover page of Quick Manual “For Overseas Use”, or “Failures encountered overseas” on page 1.

- You need to add the code from “International Call Access Code (Table 1)” that is assigned to the country you stay or “International Prefix Number for the Universal Number (Table 2)” to the head of each phone number for inquiries.
- Note that, in many cases, the universal number may not be used from a mobile phone, public phone, or hotel phone, etc.

23

&lt;Cutout lines

Access DOCOMO e-site for procedures to change your address or billing plan and for request of Information materials.

From i-mode

i Menu ▶ 料金&お申込・設定 (Charges & Applications/Setting) ▶ 各種手続き(ドコモeサイト)

[Application procedure (DOCOMO e-site)]

Packet communication charges free

From PC

My docomo (<http://www.mydocomo.com/>) ▶ 各種手続き(ドコモeサイト) [Application procedure (DOCOMO e-site)]

- You will need your "network ID" to access e-site from i-mode.
- No packet communication charges are incurred when accessing e-site from i-mode.  
Accessing from overseas will incur charges.
- You will need your "docomo ID/password" to access e-site from PC.

- If you do not have or you have forgotten your "network ID" or "docomo ID/password", contact the DOCOMO Information Center listed on the back cover of this manual.
- DOCOMO e-site may not be available depending upon the content of your subscription.
- You may not be able to access some e-site services due to system maintenance, etc.

## Do not forget your FOMA phone ... or your manners!

In the following cases, be certain to turn off the power.

### ■Where use is prohibited

Be sure to turn off the power to your FOMA phone in airplanes and in hospitals.

- ※Persons with electronic medical equipment are in places other than the actual wards.  
Make sure you have the power switched off even if you are in a lobby or waiting room.

### ■When in crowded places such as packed trains, where you could be near a person with an implanted cardiac pacemaker or implanted defibrillator

The implanted cardiac pacemaker or implanted defibrillator operation can be affected by radio emissions from the FOMA phone.

In the following cases, be certain to set Public Mode.

### ■While driving

Using the mobile phone in your hand while driving is subject to punishment.

- ※If you answer a call out of necessity, tell the caller with Hands-free that you will call him/her back, park your car to somewhere safe, and then dial.

### ■When in theaters, movie theaters, museums, and similar venues

If you use your FOMA phone where you are supposed to be quiet, you will disturb those around you.

Adjust the volume of your voice and ring tone according to where you are.

- If you use the FOMA phone in quiet places such as restaurants and hotel lobbies, keep the volume of your voice and other sounds down.
- Do not block thoroughfares when using the FOMA phone.

Respect the privacy.

Please be considerate of the privacy of individuals around you when shooting and sending photos using camera-equipped mobile phones.

These functions help you keep your manners in public.

Handy functions are available such as for setting the response to incoming calls and setting the tones to silent.

### ●Public Mode (Drive Mode/Power Off) (Page 66 and page 67)

The guidance that you are currently driving or in a place where you should refrain from using a mobile phone or the guidance that you are in a place where you should turn off the power is played back to the caller. Then the call is disconnected.

### ●Record Message function (Page 68)

Callers can record a message when you cannot come to the phone.

### ●Vibrator (Page 93)

When the vibrator is set, it vibrates for incoming calls.

### ●Manner Mode/Super Silent/Original Manner (Page 96)

In Manner Mode or Super Silent, the keypad sound, ring tone and other sounds from the FOMA phone are silenced.

In Original Manner, you can set whether or not to activate the Record Message function, and can change the settings for the vibrator and ring tone.

- ※The shutter sound cannot be silenced.

Optional services are also available, such as Voice Mail Service (page 386) and Call Forwarding Service (page 390).

This manual was produced in such a way as to allow easy recycling. Please recycle this manual when it is no longer needed.

## General inquiries

<DOCOMO Information Center>

(In English)

 **0120-005-250**  
(toll free)

\* Can be called from mobile phones and PHSs. \* Can be called only from DOCOMO mobile phones.

• Please confirm the phone number before you dial.

• For various procedures, repairs, and maintenance, dial the phone numbers listed above, or visit the DOCOMO web page or i-mode site to find your nearest DOCOMO shop, and then inquire about them.

DOCOMO web page <http://www.nttdocomo.co.jp/>

i-mode site

(In Japanese only)

 (No prefix) **151**  
(toll free)

\* Can be called only from DOCOMO mobile phones.

## Repairs

(In Japanese only)

 (No prefix) **113**  
(toll free)

\* Can be called only from DOCOMO mobile phones. \* Can be called from mobile phones and PHSs.

(In Japanese only)

 **0120-800-000**  
(toll free)

\* Can be called from mobile phones and PHSs.

i Menu ▶ お知らせ (Notice) ▶ ドコモショップ (DOCOMO Shop) (In Japanese only)

## Loss or theft of FOMA terminal or payment of cumulative cost overseas

<DOCOMO Information Center> (available 24 hours a day)

### From a DOCOMO mobile phone

International call access code for  
the country you stay (Table 1)

**-81-3-5366-3114\*** (toll free)

\* You are charged a call fee to Japan when calling from a landline phone, etc.

※ If you use P706ij, you should dial the number +81-3-5366-3114  
(to enter "+", press and hold the "0" key for at least one second).

### From a landline phone

<Universal number>

International prefix number for  
the universal number (Table 2)

**-800-0120-0151\***

\* You might be charged a domestic call fee according to the call rate for the country you stay.

※ See page 414 and page 415 for international call access codes for major countries (Table 1) and  
international prefix numbers for the universal number (Table 2).

● If you lose your FOMA phone or have it stolen, immediately take the steps necessary for suspending the use of the FOMA phone.

● If the FOMA phone you purchased malfunctions, bring your FOMA phone to a repair counter specified by DOCOMO after you return to Japan.

## Failures encountered overseas

<Network Technical Operation Center> (available 24 hours a day)

### From a DOCOMO mobile phone

International call access code for  
the country you stay (Table 1)

**-81-3-6718-1414\*** (toll free)

\* You are charged a call fee to Japan when calling from a landline phone, etc.

※ If you use P706ij, you should dial the number +81-3-6718-1414  
(to enter "+", press and hold the "0" key for at least one second).

### From a landline phone

<Universal number>

International prefix number for  
the universal number (Table 2)

**-800-5931-8600\***

\* You might be charged a domestic call fee according to the call rate for the country you stay.

※ See page 414 and page 415 for international call access codes for major countries (Table 1) and  
international prefix numbers for the universal number (Table 2).



Do not forget your mobile phone ... or your manners!

When using your mobile phone in a public place, do not forget to show common courtesy and consideration for others around you.

Sales: NTT DOCOMO, INC.

Manufacturer: Panasonic Mobile Communications Co., Ltd.



Li-ion 00

To prevent damage to the environment, bring used  
battery packs to an NTT DOCOMO service counter,  
an NTT DOCOMO agent or a recycle center.



This manual is printed using  
an ink based on soy bean oil.

July '08 (Ver.1.1)

3TR100080AAA

F0608F0



# FOMA<sup>®</sup> P706iμ

## Manual for PC Connection

Data Communication Available from FOMA Phone .....	1
Before Using Data Communication .....	1
Preparation Flow for Data Transfer (OBEX™ Communication) .....	3
Preparation Flow for Data Communication .....	3
<b>For Using Windows XP/Windows 2000</b>	
Installing FOMA Communication Setup Files (Driver) .....	4
FOMA PC Setup Software .....	7
Communication Setting by FOMA PC Setup Software .....	7
Installing FOMA PC Setup Software .....	8
Setting Communication .....	10
Carrying Out Set Communication .....	14
Uninstalling FOMA PC Setup Software .....	15
Communication Setup Optimization .....	15
Access Point Name (APN) Setting .....	16
Setting Dial-up Network .....	17
Making Dial-up Connection .....	25
Using FirstPass PC Software .....	27
<b>For Using Windows Vista</b>	
Installing FOMA Communication Setup Files (Driver) .....	28
FOMA PC Setup Software .....	30
Communication Setting by FOMA PC Setup Software .....	30
Installing FOMA PC Setup Software .....	31
Setting Communication .....	32
Carrying Out Set Communication .....	37
Uninstalling FOMA PC Setup Software .....	37
Access Point Name (APN) Setting .....	38
Setting Dial-up Network .....	39
Making Dial-up Connection .....	41
Using FirstPass PC Software .....	43
<b>Using AT Command</b>	
AT Command .....	44
AT Command List .....	45

### About Manual for PC Connection

This manual explains the items required for making data communication using FOMA P706iμ as well as how to install “FOMA communication setup files”/“FOMA PC setup software” on the CD-ROM. Some procedures and displays may differ depending on your operating environment.

## Data Communication Available from FOMA Phone

The data communication services you can use by connecting the FOMA phone to a personal computer are classified as follows: data transfer (OBEX™ communication), packet communication, and 64K data communication.

The FOMA phone is equipped with the adapter function for packet communication.

- To perform the packet communication overseas, perform it via the IP connection. (You cannot perform the packet communication via the PPP connection.)
- 64K data communication is not available overseas.

## Data Transfer (OBEX™ Communication)

You can exchange data files such as images, music files, Phonebook entries and mail messages with another FOMA phone or a personal computer.

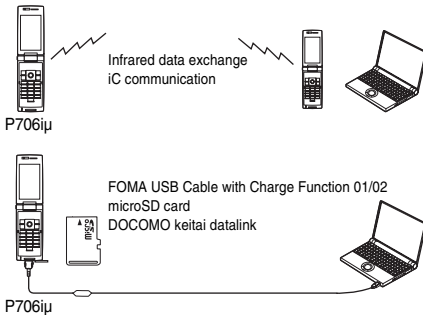

## Packet Communication

This service requires a communication fee according to the amount of data you sent and received. (Maximum download speed: 3.6 Mbps, Maximum upload speed: 384 kbps) It uses an access point which supports FOMA packet communication such as DOCOMO Internet access service “mopera U”/“mopera”.

To use this service, connect the FOMA phone to a personal computer via the FOMA USB Cable with Charge Function 01/02 (option), and then carry out settings. The packet communication is suitable for using applications which require the high-speed communication. To carry out the settings and connection, see page 3 and after.

- The packet communication is charged according to the amount of data you sent and received. Note that you are charged a high communication fee for the massive data communication such as browsing Internet web pages having many images or downloading data files.
- The data is sent/received at the maximum speed of 384 kbps outside the FOMA High-speed Area.
- When you use the packet communication with “sigmarion III”, “sigmarion II”, or “musea” of DOCOMO’s PDA, the data is sent/received at the maximum speed of 384 kbps. High-speed communication for FOMA High-speed Area is not supported.

## 64K Data Communication

This service requires a communication fee according to the duration of connection. By connecting the FOMA phone to a personal computer via the FOMA USB Cable with Charge Function 01/02 (option), you can execute communication.

To use this service, connect to an access point which supports FOMA 64K data communication such as DOCOMO Internet access service “mopera U”/“mopera”, or an ISDN-synchronous 64K access point. To carry out the settings and connection, see page 3 and after.

- The 64K data communication is charged according to the duration of connection. Note that a communication fee becomes expensive if you use this service for a long time.

## Information

- The FOMA phone does not support Remote Wakeup.
- The FOMA phone does not support the FAX communication.
- You can perform data communications by connecting the FOMA phone with DOCOMO’s PDA “sigmarion II”, “sigmarion III”, or “musea”. When you use “sigmarion II” or “musea”, the update is required. For details such as how to update them, refer to the DOCOMO web page.

## Before Using Data Communication

### Charge of Internet service provider

To use the Internet, you need to pay the charge for the Internet service provider you use. Besides the FOMA service fee, you need to directly pay this charge to the Internet service provider. For details on the charge, contact the Internet service provider you use.

You can use the DOCOMO Internet access service, “mopera U”/“mopera”. To use “mopera U”, subscription (charged) is required. To use “mopera”, subscription and monthly charge are not required. However, the maximum communication speed of sending/receiving data is limited to 384 kbps.

### Setting access point (Internet service provider, etc.)

The access points for the packet communication and 64K data communication differ. To use the packet communication, connect to an access point which supports packet communication. To use the 64K data communication, connect to an access point which supports FOMA 64K data communication or ISDN-synchronous 64K.

- You cannot connect to the DoPa access point.

## About user authentication for accessing network

User authentication (ID and password) may be required at connection to some access points. In this case, enter your ID and password on the communication software (dial-up network). ID and password are specified by the Internet service provider or network administrator of the access point. For details, contact the provider or network administrator.

## About access authentication for using browser

If you need FirstPass (user certificate), install the FirstPass PC software from the provided CD-ROM and make the setting.

For details, see “FirstPassManual” (PDF format) in the “FirstPassPCSoft” folder of the CD-ROM.

## Conditions of packet communication and 64K data communication

To carry out the communication using the FOMA phone in Japan, the following conditions are required:

- The personal computer to be used can use the FOMA USB Cable with Charge Function 01/02 (option).
- The PDA to be used should support FOMA packet communication and 64K data communication.
- Within the FOMA service area
- For packet communication, the access point should support packet communication of the FOMA.
- For 64K data communication, the access point should support the FOMA 64K data communication or ISDN-synchronous 64K.

Even when these conditions are satisfied, if the base station is congested or the radio wave conditions are bad, you may not carry out the communication.

## Operating Environment

For the data communication, the following operating environment is required for your personal computer:

Item	Description
PC main unit	PC/AT compatible model When using the FOMA USB Cable with Charge Function 01/02 (option): USB port (Universal Serial Bus Specification Rev1.1 compliant) Display resolution 800 x 600 dots, high color 16 bits or more recommended.
OS	Windows 2000, Windows XP, Windows Vista (Japanese version in each)
Memory requirements	Windows 2000: 64 Mbytes or more Windows XP: 128 Mbytes or more Windows Vista: 512 Mbytes or more (Japanese version in each)
Hard disk space size	Unused memory space of 5 Mbytes or more

- The operation on the upgraded OS is not guaranteed.
- The memory requirements and hard disk space size may vary depending on the system environment.
- The recommended environment that the Menu operates is Microsoft® Internet Explorer 6.0 or later. When the Menu does not appear after you set the CD-ROM, operate as follows:  
<For Windows XP or Windows 2000>  
Refer to the CD-ROM from “マイコンピュータ (My computer)”, then double-click “index.html”.  
<For Windows Vista>  
Refer to the CD-ROM from “コンピュータ (Computer)”, then double-click “index.html”.  
※ For Windows Vista, the recommended environment is Microsoft® Internet Explorer 7.0 or later.

When you set the CD-ROM on your personal computer, an alert message might appear on the display as shown below. This alert message appears depending on the security settings of Internet Explorer, but you can use your computer without any problem.

Click “はい (YES)”.

※ The example message below is for when you use Windows XP. The message might differ depending on the environment of the computer you use.

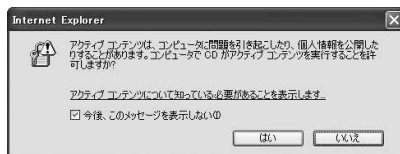

## Necessary Devices

The following hardware and software are required besides the FOMA phone and personal computer:

- FOMA USB Cable with Charge Function 01/02 (option) or FOMA USB Cable (option)
- Provided “FOMA P706iμ CD-ROM”

### Information

- Use a dedicated FOMA USB Cable with Charge Function 01/02 or FOMA USB Cable. The USB cable for personal computers cannot be used because the shape of the connector differs.
- If you use a USB hub, the devices may not work correctly.

## Connect FOMA phone to Other Devices

The following two ways are available for connecting the FOMA phone to another device:

### Use FOMA USB Cable with Charge Function 01/02

Connect the FOMA phone to a personal computer provided with the USB port using the FOMA USB Cable with Charge Function 01/02 (option). (See page 3)

This way of connection applies to all types of communications such as packet communication, 64K data communication, and data transfer.

- Set “USB mode setting” to “Communication mode” for data communication.  
Operate **[MENU]** ▶ **Settings** ▶ **Other settings** ▶ **USB mode setting** ▶ **Communication mode**”.
- You need to install the FOMA communication setup files (driver) before use.

## Use Infrared Data Exchange

By using infrared rays, you can send/receive data between your FOMA phone and another FOMA phone, mobile phone, or personal computer provided with the infrared data exchange function. This applies to data transfer only.

## Preparation Flow for Data Transfer (OBEX™ Communication)

When you use the FOMA USB Cable with Charge Function 01/02 (option), install the FOMA communication setup files.

Download or install the "FOMA communication setup files" (driver). (See page 4 and page 28)

Install the FOMA communication setup files from the provided CD-ROM, or download them from the DOCOMO web page and install.

Data transfer

## Preparation Flow for Data Communication

The following outline shows a preparation flow for packet communication or 64K data communication.

Connect a personal computer to the FOMA phone using the FOMA USB Cable with Charge Function 01/02 (option).

Download or install the "FOMA communication setup files" (driver). (※1)

Install the FOMA communication setup files from the provided CD-ROM, or download them from the DOCOMO web page and install.

Check the setting after installation. (※2)

Install the "FOMA PC setup software". (※3)

Carry out the setting manually without using the "FOMA PC setup software". (※4)

Connect. (※5)

※1-5: Depending on the OS of the personal computer, the reference page for the preparation differs.

OS of the personal computer	Reference				
	※1	※2	※3	※4	※5
Windows XP/Windows 2000	P.4	P.6	P.7	P.17 P.27	P.14 P.25
Windows Vista	P.28	P.29	P.30	P.39 P.42	P.37 P.41

## ■ Provided "FOMA P706µ CD-ROM"

When connecting the FOMA phone to your personal computer via the FOMA USB Cable with Charge Function 01/02 for packet communication, install the "FOMA communication setup files" (driver) from the provided "FOMA P706µ CD-ROM" onto the personal computer. You are advised to install "FOMA PC setup software" for establishing the APN or dial-up setting easily when you communicate.

## Connect the FOMA Phone to a PC

The following steps explain how to connect the FOMA USB Cable with Charge Function 01/02 (option).

- 1 Check the direction of the connector terminal of the FOMA phone, then straight insert the external connector of the FOMA USB Cable with Charge Function 01/02 until it clicks.
- 2 Connect the USB connector of the FOMA USB Cable with Charge Function 01/02 to the USB terminal of the personal computer.

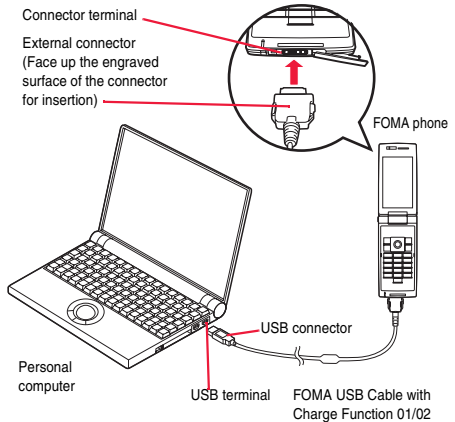

## Information

- Do not forcibly insert the FOMA USB Cable with Charge Function 01/02. Malfunction may result. Insert each connector in the correct direction at the correct angle; otherwise, you will fail connection. When the direction and angle are correct, you can insert a connector smoothly without the strong force. If you fail to insert a connector, check its shape and direction once more without inserting a connector forcibly.
- Use a dedicated FOMA USB Cable with Charge Function 01/02. (The USB cable for personal computers cannot be used because the shape of the connector differs.)
- Symbol "µ" appears on the FOMA phone when the FOMA phone recognizes the connection with the personal computer after you install the FOMA communication setup files (driver) for packet communication or 64K data communication. Before you install the FOMA communication setup files (driver), the FOMA phone does not recognize the connection with the personal computer, and symbol "µ" does not appear.

### Removing

1. While holding down the release buttons of the external connector of the FOMA USB Cable with Charge Function 01/02, straight pull out the connector.
2. Pull out the FOMA USB Cable with Charge Function 01/02 from the USB terminal of the personal computer.

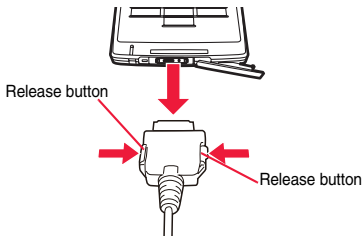

### Information

- Do not disconnect the FOMA USB Cable with Charge Function 01/02 forcibly. Malfunction may result.
- Do not disconnect the FOMA USB Cable with Charge Function 01/02 during data communication. Erroneous operation or malfunction of the personal computer or FOMA phone, or loss of data could result.
- Do not connect/disconnect the FOMA USB Cable with Charge Function 01/02 in succession. Once you connect the cable, wait for a while, then disconnect it and vice versa.

## For Using Windows XP/ Windows 2000

### Installing FOMA Communication Setup Files (Driver)

Installing the FOMA communication setup files (driver) is required when you connect the FOMA phone to your personal computer via the FOMA USB Cable with Charge Function 01/02 (option) for the first time.

- Operate as the user who has the PC administrator right.

### For Windows XP

- 1 Connect the FOMA phone and the FOMA USB Cable with Charge Function 01/02. (See page 3)
- 2 Start Windows, then set the provided “FOMA P706iμ CD-ROM” into the personal computer.

### 3 Click “データリンクソフト・各種設定ソフト (Data link software/Setup software)”.

- If this display appears during installation of the “FOMA communication setup files” (driver), close the display.



### 4 Click “インストール (Install)” under “FOMA通信設定ファイル (USBドライバ) [FOMA communication setup files (USB driver)]”.

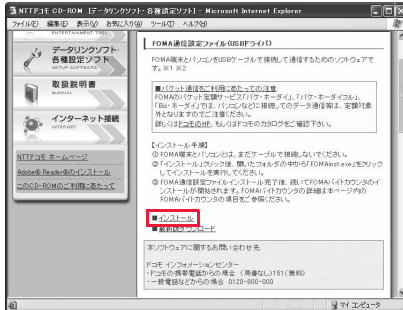

### 5 Double click “FOMAinst.exe” in opened folder.

### 6 Read “ソフトウェア使用許諾契約書 (Software licensing contract)”, and click “同意する (Agree)”.

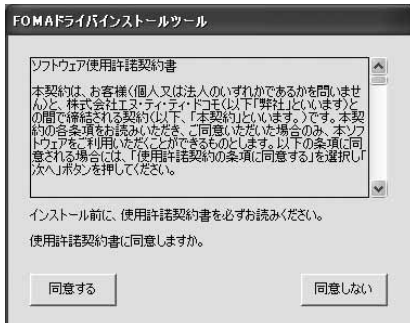

**7** Turn on the power to the FOMA phone, then connect the FOMA USB Cable with Charge Function 01/02, which is already connected to the FOMA phone, to the personal computer.

Installation starts.  
Pop-up message “新しいハードウェアが見つかりました (New hardware was found)” appears for a few seconds from the indicator of the task bar.  
After you complete the installation, pop-up message “新しいハードウェアがインストールされ、使用準備ができました。(New hardware is installed, and the system is ready.)” appears for a few seconds from the indicator of the task bar.

**8** Click “インストールする (推奨) [Installing (recommended)]”.

Then install the FOMA byte counter.  
Install by following the onscreen instructions.  
● When you do not install the FOMA byte counter, go to step 9.

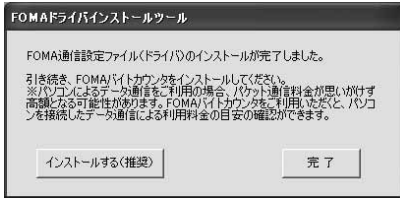

**9** Click “完了 (Complete)”.

Next, confirm that the “FOMA communication setup files” (driver) are installed correctly. (See page 6)

**For Windows 2000**

- 1** Connect the FOMA phone and the FOMA USB Cable with Charge Function 01/02. (See page 3)
- 2** Start Windows, then set the provided “FOMA P706iμ CD-ROM” into the personal computer.
- 3** Click “データリンクソフト・各種設定ソフト (Data link software/Setup software)”.

● If this display appears during installation of the “FOMA communication setup files” (driver), close the display.



**4** Click “インストール (Install)” under “FOMA通信設定ファイル (USBドライバ) [FOMA communication setup files (USB driver)]”.

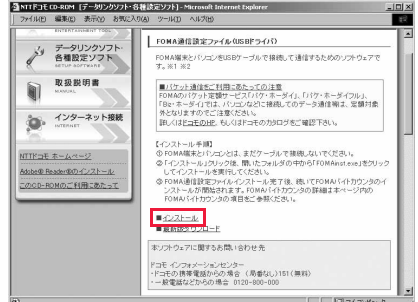

**5** Double click “FOMAinst.exe” in opened folder.

**6** Read “ソフトウェア使用許諾契約書 (Software licensing contract)”, and click “同意する (Agree)”.

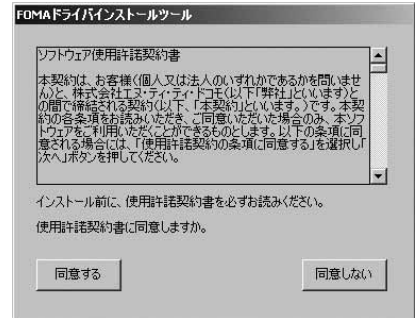

**7** Turn on the power to the FOMA phone, then connect the FOMA USB Cable with Charge Function 01/02, which is already connected to the FOMA phone, to the personal computer.

Installation starts.  
Pop-up message “新しいハードウェアが見つかりました (New hardware was found)” appears for a few seconds from the indicator of the task bar.  
After you complete the installation, pop-up message “新しいハードウェアがインストールされ、使用準備ができました。(New hardware is installed, and the system is ready.)” appears for a few seconds from the indicator of the task bar.

**8** Click “インストールする (推奨) [Installing (recommended)]”.

Then install the FOMA byte counter.  
Install by following the onscreen instructions.  
● When you do not install the FOMA byte counter, go to step 9.

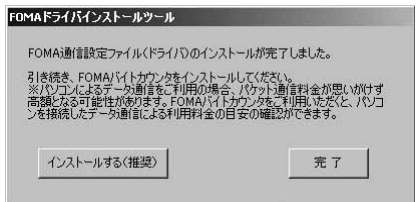

## 9 Click “完了 (Complete)”.

Next, confirm that the “FOMA communication setup files” (driver) are installed correctly. (See page 6)

### Confirm Installed Driver

Confirm that the “FOMA communication setup files” (driver) are installed correctly.

- 1 <For Windows XP>  
“スタート (Start)” ▶ Open “コントロールパネル (Control panel)” ▶ “パフォーマンスとメンテナンス (Performance and maintenance)” ▶ Open “システム (System)”.

<For Windows 2000>

- “スタート (Start)” ▶ “設定 (Setting)” ▶ Open “コントロールパネル (Control panel)” ▶ Open “システム (System)”.

- 2 Click the “ハードウェア (Hardware)” tab ▶ Click “デバイスマネージャ (Device manager)”.

- 3 Click each device, then confirm the installed driver names.

Confirm that all driver names are displayed under “ポート (COMと LPT) [Port (COM/LPT)]”, “モデム (Modem)”, and “USB (Universal Serial Bus) コントローラ [USB (Universal Serial Bus) controller]”.

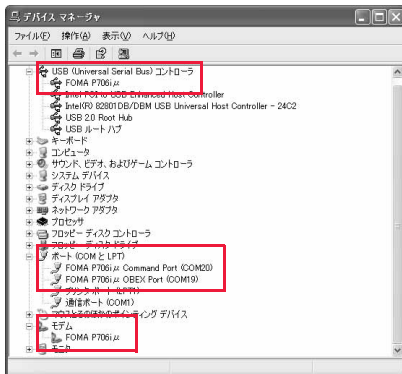

For Windows XP

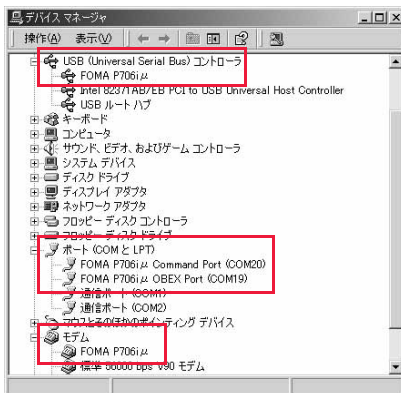

For Windows 2000

※ The COM port number varies depending on the personal computer you use.

The following drivers are installed by installation of the “FOMA communication setup files” (driver):

Device name	FOMA communication setup file (driver) name
ポート (COMとLPT) [Port (COM/LPT)]	・ FOMA P706iμ Command Port ・ FOMA P706iμ OBEX Port
モデム (Modem)	・ FOMA P706iμ
USB (Universal Serial Bus) コントローラ [USB (Universal Serial Bus) controller]	・ FOMA P706iμ

To set an access point with the “FOMA PC setup software”, see page 8.  
To set an access point without the “FOMA PC setup software”, see page 17 or page 27.

### Uninstall FOMA Communication Setup Files (Driver)

When uninstalling the “FOMA communication setup files” (driver) is necessary (such as when upgrading the version), perform the operation below. The operation here explains how to uninstall the FOMA communication setup files using Windows XP as an example.

- Operate as the user who has the PC administrator right.

- 1 If the FOMA phone is connected to a personal computer via the FOMA USB Cable with Charge Function 01/02 (option), disconnect the FOMA USB Cable with Charge Function 01/02.
- 2 “スタート (Start)” ▶ “コントロールパネル (Control panel)” ▶ Open “プログラムの追加と削除 (Add and delete programs)”.
- 3 Select “FOMA P706iμ USB” and click “変更と削除 (Change and delete)”.
- 4 Click “OK”.



## 5 Click “はい (Yes)” to restart Windows.

The uninstallation is then completed.

- If you click “いいえ (No)”, restart Windows manually.

### Information

- If you remove the FOMA USB Cable with Charge Function 01/02 from the personal computer while installing the “FOMA communication setup files” (driver) or click the “キャンセル (Cancel)” button to stop installation, the “FOMA communication setup files” (driver) may not be installed correctly. In this case, open “P706iμ\_USB\_Driver” → “Drivers” → “Win2k\_XP” inside “FOMA P706iμ CD-ROM”, and execute “p706iμun.exe” to delete the “FOMA communication setup files” (driver), and then install the files again.

## FOMA PC Setup Software

To connect the FOMA phone to a personal computer and perform the packet communication or 64K data communication, you need to configure various settings related to the communication. Using the “FOMA PC setup software”, you can easily carry out the settings below. If required, you can set the packet communication and 64K data communication without using the “FOMA PC setup software”. (See page 17 and page 27)

### ■ Easy setting

You can easily carry out “dial-up creation for FOMA data communication” and “Communication setup optimization” by following the guidance.

### ■ Communication setup optimization

Before using “FOMA packet communication”, optimize communication settings in your personal computer.

To maximize the communication performance, communication setup optimization is needed.

### ■ Access point name (APN) setting

You can set an access point name (APN) required for packet communication.

The FOMA packet communication does not use an ordinary phone number as an access point unlike the 64K data communication.

You need to register an access point name (APN) in the FOMA phone in advance, and specify the registration number (cid) in the access point number field for connection.

By the default, “mopera.ne.jp”, the access point name (APN) of “mopera”, is registered in cid※1, and “mopera.net”, that of “mopera U”, is registered in cid※3. To connect to another service provider or Intranet LAN, however, you need to set the access point name (APN).

※“cid” is the abbreviation of “Context Identifier”, the number for storing the packet communication access point name (APN) to the FOMA phone.

### Information

- If the old-version “W-TCP設定ソフト (W-TCP setup software)”, the old-version “FOMAデータ通信設定ソフト (FOMA data communication setup software)” or the older version than this “FOMA PC設定ソフト (FOMA PC setup software)” (older than version 4.0.0) is installed, uninstall it in advance.

## Communication Setting by FOMA PC Setup Software

### STEP1 Install Software

#### Install the “FOMA PC setup software”.

See page 8 for installation.

If the older version than this “FOMA PC setup software” (version 4.0.0) is already installed, you cannot install this “FOMA PC setup software”, so uninstall it in advance. See page 9 if the display appears to indicate that the old-version “W-TCP設定ソフト (W-TCP setup software)”, or the old-version “FOMAデータ通信設定ソフト (FOMA data communication setup software)” is installed.

### STEP2 Prepare for Setup

#### Prepare for setup.

Before setup, confirm that the FOMA phone is connected to your personal computer and correctly recognized by the personal computer. See page 3 for how to connect the FOMA USB Cable with Charge Function 01/02 (option).

If the FOMA phone is not correctly recognized by the personal computer, you cannot carry out settings and communication. See page 6 for confirming whether the FOMA phone is correctly recognized by the personal computer.

See page 4 through page 7 for how to install the “FOMA communication setup files” (driver).

### STEP3 Setting Operation

#### Carry out the appropriate setting for the communication you use.

Setting the packet communication from “Easy Setting”

When using “mopera U” or “mopera” as an access point  
..... page 10

When using a provider other than “mopera U” or “mopera”  
..... page 11

Setting the 64K data communication from “Easy Setting”

When using “mopera U” or “mopera” as an access point  
..... page 12

When using a provider other than “mopera U” or “mopera”  
..... page 13

See page 15 for optimizing the packet communication performance.

See page 16 for setting an access point name (APN).

### STEP4 Connection

#### Connect to the Internet.



## Installing FOMA PC Setup Software

To connect the FOMA phone to a personal computer and perform the packet communication or 64K data communication, you need to configure various settings related to the communication.

Using the "FOMA PC setup software", you can easily set up dial-up, communication setup optimization, and access point name (APN).

- Operate as the user who has the PC administrator right.

## Notes for Installing FOMA PC Setup Software

Confirm that the FOMA phone is correctly recognized by your personal computer

Before installing the "FOMA PC setup software", you need to register the "FOMA communication setup files" (driver) correctly on the device of the personal computer. (See page 6)

■When you connect the FOMA phone to your personal computer for the first time

The wizard shown below starts.

To use the FOMA data communication, you need to register the FOMA phone in your personal computer as a communication device.

See page 4 through page 7 for installation of the "FOMA communication setup files" (driver).

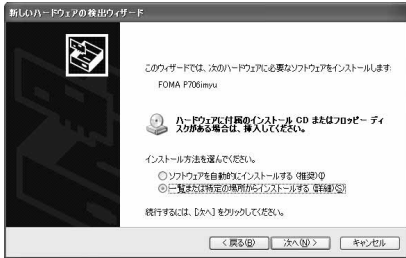

## Install FOMA PC Setup Software

The explanation here uses the displays for when installing the FOMA PC setup software on Windows XP. The displays are slightly different depending on the personal computer you use.

- 1 Set the provided "FOMA P706imu CD-ROM" into your personal computer.

- 2 To install the "FOMA PC setup software", click "データリンクソフト・各種設定ソフト (Data link software/Setup software)".

- If this display appears during installation of the "FOMA PC setup software", close the display.



- 3 Click "インストール (Install)" under "FOMA PC 設定ソフト (FOMA PC setup software)".

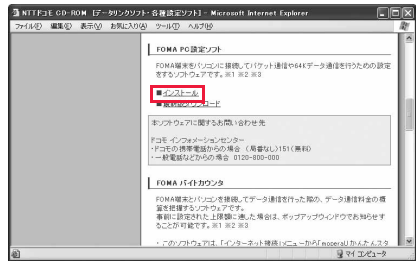

When you click "インストール (Install)", an alert message might appear in the screen as shown below. This alert message appears depending on the security settings of Internet Explorer, but you can use your computer without any problem.

- When the "ファイルのダウンロード - セキュリティの警告 (File download - Security alert)" window appears: Click "実行 (Execute)".

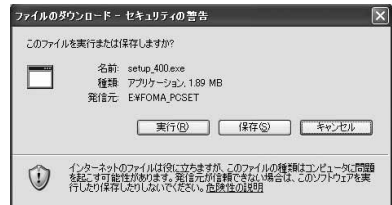

- When the "Internet Explorer - セキュリティの警告 (Internet Explorer - Security alert)" window appears: Click "実行する (Execute)".
- "不明な発行者 (Unknown publisher)" is displayed in the "発行元 (Publisher)" field, but this is not a problem.

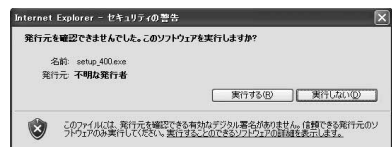

## 4 Click “はい (YES)”▶Click “次へ (Next)”.

Before starting setup, check that no other programs are currently running. If any program is running, click “キャンセル (Cancel)” to save and exit the program, then restart installation.

- See page 9 if the display appears to indicate that the old-version “W-TCP設定ソフト (W-TCP setup software)”, old-version “FOMA データ通信設定ソフト (FOMA data communication setup software)” or old-version “FOMA PC設定ソフト (FOMA PC setup software)” is installed.

## 5 Confirm the displayed contract contents.

If you agree with the contents, click “はい (Yes)”.

## 6 Select a setup type.

After setup, you can select whether “Communication setup optimization” resides on the task tray. To make it reside, check “タスクトレイに常駐する (Reside on the task tray)” and click “次へ (Next)”, then continue installation.

- Even if you do not check “タスクトレイに常駐する (Reside on the task tray)”, you can select “メニュー (Menu)”→“通信設定最適化をタスクトレイに常駐させる (Make the communication setup optimization reside on the task tray)” on the “FOMA PC setup software” to modify settings.



The “W-TCP” icon appears on the task tray at the bottom right (ordinarily) of the desk top.



## 7 Confirm the installation destination, then click “次へ (Next)”.

To change the installation destination, click “参照 (Browse)”; specify any installation destination; then click “次へ (Next)”.

(You can install the FOMA PC setup software in a different drive, however, proceed without changing unless you have a problem on hard disk space, etc.)

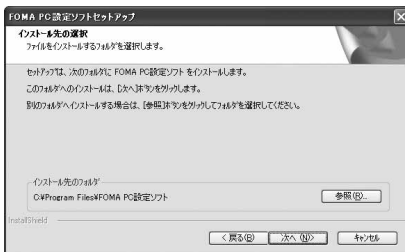

## 8 Confirm the program folder name, then click “次へ (Next)”.

To change the program folder name, enter a new one, then click “次へ (Next)”.

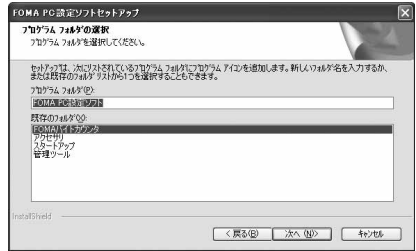

## 9 Click “完了 (Complete)”.

After setup is completed, the “FOMA PC setup software” operation display appears.

### ■Displays at installation of the “FOMA PC setup software”

**When the old-version “W-TCP設定ソフト (W-TCP setup software)” is installed**

A warning display appears.

From “アプリケーションの追加と削除 (Add and delete application)”, uninstall the old-version “W-TCP設定ソフト (W-TCP setup software)”.

**When the old-version “FOMAデータ通信設定ソフト (FOMA data communication setup software)” is installed**

A warning display appears.

From “アプリケーションの追加と削除 (Add and delete application)”, uninstall the old-version “FOMAデータ通信設定ソフト (FOMA data communication setup software)”.

**When the older version than this “FOMA PC設定ソフト (FOMA PC setup software)” (version 4.0.0) is installed**

A warning display appears.

From “アプリケーションの追加と削除 (Add and delete application)”, uninstall the old-version “FOMA PC設定ソフト (FOMA PC setup software)”.

**When you click “キャンセル (Cancel)” during the installation**

A confirmation display appears when you click “キャンセル (Cancel)” or “しりえ (No)” during the setup operation. To continue the installation, click “しりえ (No)”. To intentionally cancel, click “はい (Yes)” and “完了 (Complete)”.

### ■Checking the version information about “FOMA PC setup software”



Select “メニュー (Menu)”→“バージョン情報 (Version information)” from the menu of the “FOMA PC setup software”.

The version information about the “FOMA PC setup software” is displayed.

## Setting Communication

The operation below explains how to carry out various settings related to the packet communication and 64K data communication.

There are “auto setting” for easy operation and “manual setting” for the user familiar with personal computers. Before setting, confirm that the FOMA phone is connected to your personal computer.

- 1 “スタート (Start)”▶“すべてのプログラム (All programs)”▶“FOMA PC設定ソフト (FOMA PC setup software)”▶Open “FOMA PC設定ソフト (FOMA PC setup software)”.

<For Windows 2000>

Select “スタート (Start)”→“プログラム (Programs)”→“FOMA PC設定ソフト (FOMA PC setup software)”→Open “FOMA PC設定ソフト (FOMA PC setup software)”.

Using this PC setup software, you can easily create FOMA dial-up setting by answering (selecting and entering) the displayed questions according to “the information of connected provider” and “connection method” you selected.

- See page 10 for setting the packet communication from “かんたん設定 (Easy Setting)”.
- See page 12 for setting the 64K data communication from “かんたん設定 (Easy Setting)”.
- See page 15 for executing “通信設定最適化 (communication setup optimization)”.
- See page 16 for setting “接続先 (APN) 設定 [access point name (APN) setting]”.

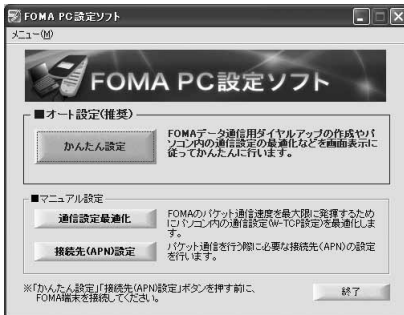

## Specify Communication Port

- 1 “メニュー (Menu)” of “FOMA PC setup software”▶Select “通信設定 (Communication setup)”.

• 自動設定 (推奨) [Auto-setup (recommended)]  
The connected FOMA phone is automatically specified. Usually, select “Auto-setup”.

• COMポート指定 (Specifying COM port)  
When specifying a COM port number, specify the COM port number (COM1 through 99) the FOMA phone is connected to.

- See page 18 for how to check the COM port number.



- 2 Click “OK”.

The settings are applied.

## Select Packet Communication from “かんたん設定 (Easy Setting)”

### Using “mopera U” or “mopera” as an access point

This section explains how to make settings for a high-speed packet communication of 3.6 Mbps maximum. This setting is for when you use DOCOMO Internet connection service “mopera U” or “mopera” as a provider.

**High-speed packet communication:**

You are charged according to the amount of data sent/received. You can execute data communication without worrying about time.

**High-speed packet communication of up to 3.6 Mbps for receiving and up to 384 kbps for sending is available.**

**Note that a communication fee becomes expensive if you send/receive a large amount of data such as by browsing web pages having many images, or by downloading the data.**

- The communication speed for both sending and receiving is up to 384 kbps for “mopera” connection.

- 1 Click “かんたん設定 (Easy Setting)”.

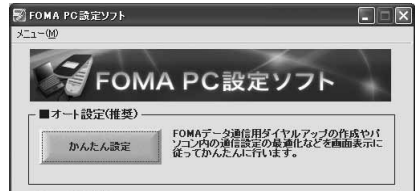

- 2 Select “パケット通信 (HIGH-SPEED対応端末) (Packet communication (HIGH-SPEED compatible terminal))”, then click “次へ (Next)”.

Confirm that “パケット通信 (HIGH-SPEED対応端末) (Packet communication (HIGH-SPEED compatible terminal))” is checked, then click “次へ (Next)”.

- 3 Select “『mopera U』への接続 (Connect to mopera U)” or “『mopera』への接続 (Connect to mopera)”, then click “次へ (Next)”.

To use “mopera U”, select “『mopera U』への接続 (Connect to mopera U)”. To use “mopera”, select “『mopera』への接続 (Connect to mopera)”.

When “『mopera U』への接続 (Connect to mopera U)” is selected, the confirmation display appears asking whether you have signed up for it. If you have signed up, click “はい (YES)”.

- See page 11 for using a provider other than “mopera U” or “mopera”.

- 4 Click “OK”.

- The system obtains the access point name (APN) setting from the FOMA phone connected to the personal computer. Wait for a while.

## 5 Enter an access point name, then click “次へ (Next)”.

You can specify any name for the currently created connection. Enter a plain name in the “接続名 (Connection name)” field.

- You cannot enter the following half-pitch characters: ¥, /, :, \*, ?, !, <, >, |, and “.”.
- You need to notify your caller ID for connecting to “mopera U” or “mopera”. Select “設定しない (推奨) [Not set (recommended)]” or “186を付加する (通知する) [Add 186 (notify)]”.
- For the setting of “発信者番号通知 (caller ID notification)”, select “設定しない (推奨) [Not set (recommended)]” for overseas use.
- “mopera U” supports connection types of both “PPP接続 (PPP connection)” and “IP接続 (IP connection)”. For overseas use, select “IP接続 (IP connection)”. “mopera” supports connection types of “PPP接続 (PPP connection)” only. “mopera” is not available overseas.

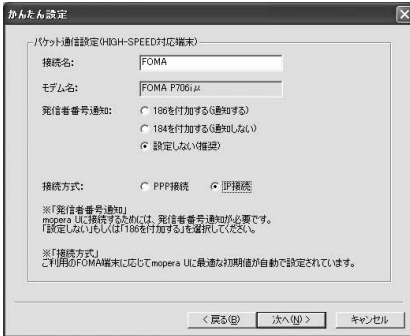

## 6 Click “次へ (Next)”.

If the access point is “mopera U” or “mopera”, you can connect even if the “ユーザ名 (user name)” and “パスワード (password)” fields are blank.

- Select a user optionally.

## 7 Put a check mark for “最適化を行う (Optimize)”, then click “次へ (Next)”.

The confirmation display appears asking whether to optimize all the communication settings for the FOMA HIGH-SPEED compatible terminal, then click “はい (Yes)”.

- If optimized already, the confirmation display to optimize does not appear.

## 8 Confirm the set information, then click “完了 (Complete)”.

The set contents are listed on the display. Confirm that there is no problem on the set contents, then click “完了 (Complete)”.

- To change the set contents, click “戻る (Back)”.
- If “デスクトップにダイヤルアップのショートカットを作成する (Create a dial-up shortcut on the desktop)” is checked, a dial-up shortcut will be created on the desktop.

## 9 Click “OK”.

The setting is completed.

Open the dial-up shortcut icon automatically created on the desktop; then the connection display for starting communications appears. After confirming that the connection starts, you can start the Internet browser or mail browser for communication. (See page 14)

- To make the optimization valid, you need to restart the personal computer.



## Using a provider other than “mopera U” or “mopera” as an access point

The packet communication is a communication system you are charged according to the amount of data you sent and received, regardless of the communication time and distance. (Maximum download speed: 3.6 Mbps, Maximum upload speed: 384 kbps)

To use a provider other than “mopera”, you may need to separately apply for the service and sign a contract with the provider.

## 1 Click “かんたん設定 (Easy Setting)”.

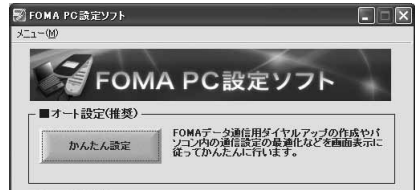

## 2 Select “パケット通信 (HIGH-SPEED対応端末) (Packet communication (HIGH-SPEED compatible terminal))”, then click “次へ (Next)”.

Confirm that “パケット通信 (HIGH-SPEED対応端末) (Packet communication (HIGH-SPEED compatible terminal))” is checked, then click “次へ (Next)”.

## 3 Select “その他 (Others)”, then click “次へ (Next)”.

Confirm that “その他 (Others)” is checked, then click “次へ (Next)”.

## 4 Click “OK”.

- The system obtains the access point name (APN) setting from the FOMA phone connected to the personal computer. Wait for a while.

## 5 Enter an access point name.

You can specify any name for the currently created connection. Enter a plain name in the “接続名 (Access point name)” field.

- You cannot enter the following half-pitch characters: ¥, /, :, \*, ?, !, <, >, |, and “.”.
- In the “接続先 (APN) の選択 [Select an access point name (APN)]” field, “mopera.ne.jp (PPP接続) [mopera.ne.jp (PPP connection)]” is displayed as the default. Go to the “接続先 (APN) 設定 [Set an access point name (APN)]” display.
- For the setting of “発信者番号通知 (caller ID notification)”, follow the information from the provider and others. For overseas use, select “設定しない (Not set)”.



## 6 Click “接続先 (APN) 設定 [Set an access point name (APN)]”.

“mopera.ne.jp” is registered in “cid1” and “mopera.net” is registered in “cid3” by default. Click “追加 (Add)”, then enter the correct access point name (APN) for FOMA packet communication on the “接続先 (APN) の追加 [Add an access point name (APN)]” display. Click “OK”. The “パケット通信設定 (Packet communication setting)” display returns. Select the access point name (APN) you specified newly. If it is ok, click “OK”.

- For a provider access point name (APN) or supported connection types, contact your provider.



## 7 Click “詳細情報の設定 (Set detailed information)”.

The display for specifying “IPアドレス (IP address)” and “ネームサーバー (name server)” appears. When entering dial-up information for the provider you have subscribed or Intranet LAN system, specify addresses according to the entry instruction information, then click “OK”.

## 8 Click “次へ (Next)”.

## 9 Specify “ユーザー名 (User name)” and “パスワード (Password)”, then click “次へ (Next)”.

When specifying the user name and password, correctly enter the information supplied from your Internet service provider, taking care of uppercase and lowercase letters and so on.

- Select a user optionally.

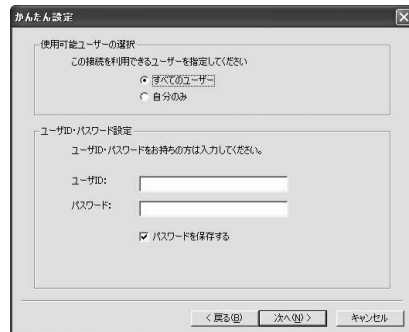

## 10 Put a check mark for “最適化を行う (Optimize)”, then click “次へ (Next)”.

The confirmation display appears asking whether to optimize all the communication settings for the FOMA HIGH-SPEED compatible terminal, then click “はい (Yes)”.

- If optimized already, the confirmation display to optimize does not appear.

## 11 Confirm the set information, then click “完了 (Complete)”.

The set contents are listed on the display. Confirm that there is no problem on the set contents, then click “完了 (Complete)”.

- To change the set contents, click “戻る (Back)”.
- If “デスクトップにダイヤルアップのショートカットを作成する (Create a dial-up shortcut on the desktop)” is checked, a dial-up shortcut will be created on the desktop.

## 12 Click “OK”.

The setting is completed.

Open the dial-up shortcut icon automatically created on the desktop; then the connection display for starting communications appears. After confirming that the connection starts, you can start the Internet browser or mail browser for communication. (See page 14)

- To make the optimization valid, you need to restart the personal computer.



## Select 64K Data Communication from “かんたん設定 (Easy Setting)”

### Using “mopera U” or “mopera” as an access point

The 64K data communication is a communication system you are charged according to the duration of connection. (Maximum communication speed: 64 kbps) You can use the DOCOMO Internet access service, “mopera U”/“mopera”.

## 1 Click “かんたん設定 (Easy Setting)”.

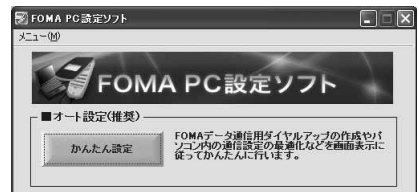

## 2 Select “64Kデータ通信 (64K data communication)”, then click “次へ (Next)”.

Confirm that “64Kデータ通信 (64K data communication)” is checked, then click “次へ (Next)”.

## 3 Select “[mopera U] への接続 (Connect to mopera U)” or “[mopera] への接続 (Connect to mopera)”, then click “次へ (Next)”.

To use “mopera U”, select “[mopera U] への接続 (Connect to mopera U)”. To use “mopera”, select “[mopera] への接続 (Connect to mopera)”.

When “[mopera U] への接続 (Connect to mopera U)” is selected, the confirmation display appears asking whether you have signed up for it. If you have signed up, click “はい (YES)”.

- See page 13 for using a provider other than “mopera U” or “mopera”.

## 4 Enter an access point name, then click “次へ (Next)”.

You can specify any name for the currently created connection. Enter a plain name in the “接続名 (Access point name)” field. Confirm that “FOMA P706μ” is displayed in the “モデムの選択 (Select a modem)” field.

- You cannot enter the following half-pitch characters: ¥, /, :, \*, ?, !, <, >, !, and “.”.
- Set whether to notify your caller ID for dial-up connection. You need to notify your caller ID for connecting to “mopera U” or “mopera”.



## 5 Click “次へ (Next)”.

If the access point is “mopera U” or “mopera”, you can connect even if the “ユーザー名 (user name)” and “パスワード (password)” fields are blank.

- Select a user optionally.

## 6 Confirm the set information, then click “完了 (Complete)”.

The set contents are listed on the display. Confirm that there is no problem on the set contents, then click “完了 (Complete)”.

- To change the set contents, click “戻る (Back)”.
- If “デスクトップにダイヤルアップのショートカットを作成する (Create a dial-up shortcut on the desktop)” is checked, a dial-up shortcut will be created on the desktop.

## 7 Click “OK”.

The setting is completed.

Open the dial-up shortcut icon automatically created on the desktop; then the connection display for starting communications appears. After confirming that the connection starts, you can start the Internet browser or mail browser for communication. (See page 14)



## 3 Select “その他 (Others)”, then click “次へ (Next)”.

Confirm that “その他 (Others)” is checked, then click “次へ (Next)”.

## 4 Enter dial-up information.

When connecting to a provider supporting ISDN-synchronous 64K other than “mopera U” or “mopera”, register the following items when creating the dial-up.

- ① “接続名 (Access point name)” (arbitrary)
  - ② “モデムの選択 (Select a modem)” (FOMA P706μ)
  - ③ “電話番号 (Phone number of provider access)”
  - ④ Set whether to notify your caller ID for dial-up connection.
- Correctly enter these items according to the provider information.
- For the setting of the caller ID notification, follow the instructions from the provider you use.
  - You cannot enter the following half-pitch characters in the “接続名 (Access point name)” field: ¥, /, :, \*, ?, !, <, >, !, and “.”.



## 5 Click “詳細情報の設定 (Set detailed information)”.

The display for specifying “IPアドレス (IP address)” and “ネームサーバー (name server)” appears. When entering dial-up information for the provider you have subscribed or Intranet LAN system, specify addresses according to the entry instruction information, then click “OK”.

## 6 Click “次へ (Next)”.

## 7 Specify “ユーザー名 (User name)” and “パスワード (Password)”, then click “次へ (Next)”.

When specifying the user name and password, correctly enter the information supplied from your Internet service provider, taking care of uppercase and lowercase letters and so on.

- Select a user optionally.

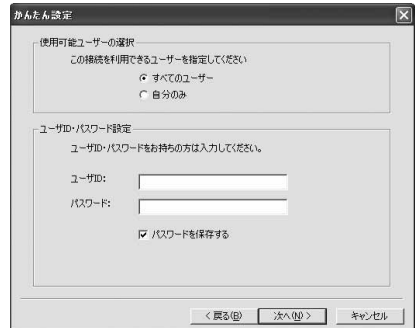

## Using a provider other than “mopera U” or “mopera” as an access point

The 64K data communication is a communication system you are charged according to the duration of connection. (Maximum communication speed: 64 kbps) To use a provider other than “mopera”, you may need to separately apply for the service and sign a contract with the provider.

## 1 Click “かんたん設定 (Easy Setting)”.

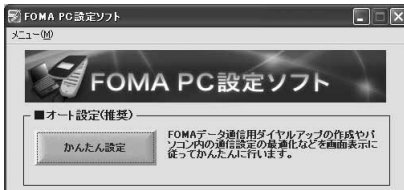

## 2 Select “64Kデータ通信 (64K data communication)”, then click “次へ (Next)”.

Confirm that “64Kデータ通信 (64K data communication)” is checked, then click “次へ (Next)”.



## 8 Confirm the set information, then click “完了 (Complete)”.

The set contents are listed on the display. Confirm that there is no problem on the set contents, then click “完了 (Complete)”.

- To change the set contents, click “戻る (Back)”.
- If “デスクトップにダイヤルアップのショートカットを作成する (Create a dial-up shortcut on the desktop)” is checked, a dial-up shortcut will be created on the desktop.

## 9 Click “OK”.

The setting is completed.

Open the dial-up shortcut icon automatically created on the desktop; then the connection display for starting communications appears. After confirming that the connection starts, you can start the Internet browser or mail browser for communication. (See page 14)



## Carrying Out Set Communication

The operation below explains how to make a dial-up connection using Windows XP as an example. Perform the operation on page 3 to connect the FOMA phone to your personal computer.

## 1 Double-click the dial-up shortcut icon on the desktop.

Open the FOMA connection shortcut icon created at communication setting; the connection display for starting communication appears.

- Bring up the icon by the following operations if it is not displayed:

<For Windows XP>

“スタート (Start)”→“すべてのプログラム (All programs)”→“アクセサリ (Accessories)”→“通信 (Communications)”→“ネットワーク接続 (Network connection)”

<For Windows 2000>

“スタート (Start)”→“プログラム (Program)”→“アクセサリ (Accessories)”→“通信 (Communications)”→“ネットワークとダイヤルアップ接続 (Network and dial-up connections)”



## 2 Enter “ユーザー名 (User name)” and “パスワード (Password)”, then click “ダイヤル (Dial)”.

- For “mopera U” or “mopera”, you can connect even if the “ユーザー名 (User name)” and “パスワード (Password)” fields are blank.
- When you put a check mark for “次のユーザーが接続するとき使用するために、このユーザー名とパスワードを保存する (Save this user name and the password for the next user to use for connecting)”, this user or all users do not need to enter them from the next time.

FOMA へ接続

ユーザー名(U):

パスワード(P):

次のユーザーが接続するとき使用するために、このユーザー名とパスワードを保存する(S)

このユーザーのみ(M)

このコンピュータを使っているすべてのユーザー(A)

ダイヤル(D): \*00\*\*3#

ダイヤル(D) キャンセル プロパティ(Q) ヘルプ(H)

## 3 Click the dial-up icon on the task tray to check for the connection.

- You can start the browser software to browse web pages, use e-mail, and so on.



### Information

- Use the FOMA phone with the dial-up setting completed for dial-up connection. To connect another FOMA phone, you may need to reinstall the FOMA communication setup files (driver).
- The power consumption of the FOMA phone increases during communication.
- During packet communication, the communication state appears on the FOMA phone.

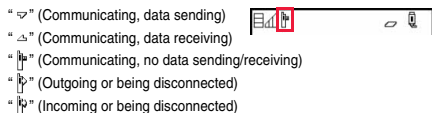

- During 64K data communication, "通信中、データ送信中" appears on the FOMA phone.



### Disconnecting

## 1 Click the dial-up icon on the task tray.



## 2 Click “切断 (Disconnect)”.

### Information

- The communication line may not be disconnected by only exiting the browser software. To surely disconnect the communication line, perform this operation.
- The baud rate displayed on your personal computer may be different from the actual one.

## Uninstalling FOMA PC Setup Software

### Before Uninstalling

Before uninstalling the “FOMA PC setup software”, reset the contents modified for the FOMA phone to the default.

#### 1 Exit the currently running programs.

- Exit the “通信設定最適化ソフト (Communication setup optimization software)”.

Right click “通信設定最適化ソフト (Communication setup optimization software)” on the task tray at the bottom right of the display, and select “終了 (Exit)”.

Right-click

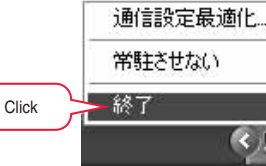

- Exit the “FOMA PC setup software”. Click “終了 (Exit)” at the bottom right of the FOMA PC setup software.
- If you try to uninstall during running of the “FOMA PC setup software” or “Communication setup optimization software”, the display below appears. Stop the uninstallation processing, and exit those programs.

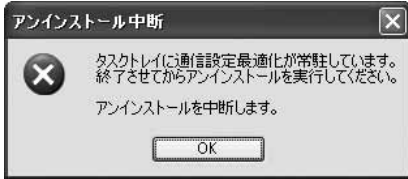
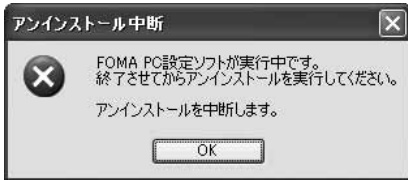

### Uninstall

The explanation here uses the displays for when you uninstall the software on Windows XP. The displays differ depending on the personal computer you use.

- Operate as the user who has the PC administrator right.

#### 1 “スタート (Start)”▶“コントロールパネル (Control panel)”▶Open “プログラムの追加と削除 (Add and delete programs)”.

<For Windows 2000>

“スタート (Start)”▶“設定 (Setting)”▶“コントロールパネル (Control panel)”▶“アプリケーションの追加と削除 (Add and delete applications)”

#### 2 Select “NTT DoCoMo FOMA PC設定ソフト (NTT DoCoMo FOMA PC setup software)”, then click “削除 (Delete)”.



#### 3 Confirm the name of the program you want to delete, then click “はい (Yes)”.

The uninstallation starts, and applications (programs) are deleted.

#### 4 Click “完了 (Finish)”.

Uninstalling the “FOMA PC setup software” is completed.

#### ■Releasing “通信設定最適化 (Communication setup optimization)”

If communication setup optimization is executed, the display below appears. Usually, click “はい (Yes)” to release the optimization.

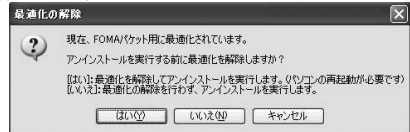

To make the settings valid, select “はい、今すぐコンピュータを再起動します。(Yes, restart computer right now)” and click “完了 (Complete)”.

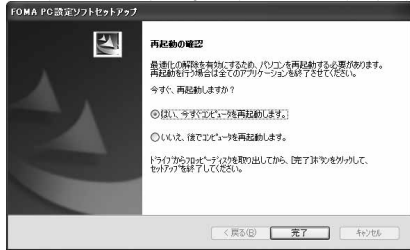

## Communication Setup Optimization

### Role of Communication Setup Optimization

The “通信設定最適化 (Communication setup optimization)” is a “TCP parameter setup” tool used to optimize the TCP/IP transmission capability at packet communication via the FOMA network. To maximize the communication performance of the FOMA phone, you need to optimize the communication setting by this software. If you put a check mark for “最適化を行う (Optimize)” in “かんたん設定 (Easy Setting)” to create dial-up information, you do not need to carry out the optimization here.

- When you perform PC connection overseas, release the communication setup optimization before the connection.



## Optimization Setting and Its Deletion

### For Windows XP

For Windows XP, you can set optimization for each dial-up information. For HIGH-SPEED communication, however, all the communication settings are optimized.

- 1 <Operating from the “FOMA PC設定ソフト (FOMA PC setup software)”>  
Start “FOMA PC設定ソフト (FOMA PC setup software)”, then click “通信設定最適化 (Communication setup optimization)” in “マニュアル設定 (Manual setup)”.

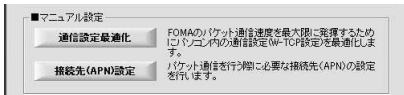

<Operating from the task tray>

Click the “Communication setup optimization icon” on the task tray to start the program.



- 2 <If the system setting is not optimized>  
Click “最適化を行う (Optimize)”.  
Select “FOMA HIGH-SPEED対応端末 (受信最大3.6Mbps) [FOMA HIGH-SPEED compatible terminal (Maximum download speed: 3.6 Mbps)]”. The confirmation display appears asking whether to optimize all the communication settings for the FOMA HIGH-SPEED compatible terminal, then click “はい (Yes)”.
- <Releasing the optimization>  
Click “最適化を解除する (Release optimization)”.

When releasing the setting to carry out communication via a device other than the FOMA phone, release the optimization.

- 3 Click “OK”.
- 4 Click “はい (Yes)”.

To make the settings valid, restart the personal computer.

### For Windows 2000

- 1 <Operating from the “FOMA PC設定ソフト (FOMA PC setup software)”>  
Start “FOMA PC設定ソフト (FOMA PC setup software)”, then click “通信設定最適化 (Communication setup optimization)” in “マニュアル設定 (Manual setup)”.

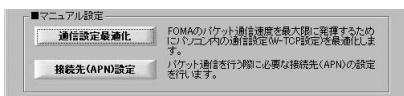

<Operating from the task tray>

Click the “Communication setup optimization icon” on the task tray to start the program.



- 2 <If not optimized>  
Click “最適化を行う (Optimize)”.

When you select “FOMA HIGH-SPEED対応端末 (受信最大3.6Mbps) [FOMA HIGH-SPEED compatible terminal (Maximum download speed: 3.6 Mbps)]”, click “はい (Yes)”.

- <If optimized>  
Click “最適化を解除する (Release optimization)”.

When releasing the setting to carry out communication via a device other than the FOMA phone, release the optimization.

- 3 Click “OK”.
- 4 Click “はい (Yes)”.

To make the settings valid, restart the personal computer.

## Access Point Name (APN) Setting

The operation below explains how to set an access point name (APN) for packet communication. The FOMA packet communication does not use an ordinary phone number as an access point unlike the 64K data communication. For each access point, register an access point name (APN) in the FOMA phone beforehand, then specify the registration number (cid) in the access point phone number field for connection. “cid” is the abbreviation of “Context Identifier”, the number for storing the packet communication access point name (APN) in the FOMA phone. (See page 20)

- 1 Start the “FOMA PC設定ソフト (FOMA PC setup software)”, then click “接続先 (APN) 設定 [Access point name (APN) setting]” in “マニュアル設定 (Manual setup)”.

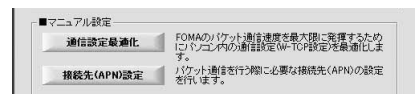

- 2 Click “OK”.

When you click “OK”, the system automatically accesses the connected FOMA phone and reads the registered “access point name (APN) setting”. You can obtain the setting information also from “ファイル (File)”→“FOMA端末から設定を取得 (Obtain the setting from the FOMA phone)” on the menu in step 3.

### 3 Set an access point name (APN).

- If the FOMA phone is not connected, this display does not appear.



#### Adding, editing, and deleting an access point name (APN)

- To add an access point name (APN), click “追加 (Add)”.
  - To edit (correct) a registered access point name (APN), click “編集 (Edit)”.
  - To delete a registered access point name (APN), select the target access point name (APN), then click “削除 (Delete)”.
- ※ You cannot delete the access point name (APN) registered in “cid1” and “cid3”. (Even if you select “cid3” and click “削除 (Delete)”, it is not deleted actually and “mopera.net” returns.)

#### Saving data into a file

From the menu, select “ファイル (File)”→“上書き保存 (Overwrite and save)” or “名前を付けて保存 (Rename and save)”; you can back up the access point name (APN) setting registered in the FOMA phone or save the currently edited access point name (APN) setting.

#### Reading data from a file

From the menu, select “ファイル (File)”→“開く (Open)”; you can obtain the access point name (APN) setting saved in the personal computer.

#### Reading access point name (APN) information from the FOMA phone

From the menu, select “ファイル (File)”→“FOMA端末から設定を取得 (Obtain the setting from the FOMA phone)”; you can obtain the access point name (APN) setting from the FOMA phone.

#### Writing access point name (APN) information to the FOMA phone

Click “FOMA端末へ設定を書き込む (Write the setting to the FOMA phone)”; you can write the displayed access point name (APN) setting to the FOMA phone.

You cannot write the IP information to the FOMA phone which does not support the IP connection.

#### Dial-up information creation function

Select an access point name (APN) you add or edit on the access point name (APN) setting display, then click “ダイヤルアップ作成 (Create dial-up information)”; you can create dial-up information for packet communication. If the access point name (APN) setting is not written to the FOMA phone, the FOMA phone setting writing confirmation display then appears, then click “はい (Yes)”. After writing ends, the “パケット通信ダイヤルアップ作成画面 (packet communication dial-up information creation display)” appears.

Enter any access point name, then click “ユーザID・パスワードの設定 (Specify user ID and password)”. (You can leave it blank to connect to “mopera U” or “mopera”.)

Enter the user name and password, select the authorized user, and then click “OK”.

If your Internet service provider instructs you to specify IP and DNS information, click “詳細情報の設定 (Set detailed information)”, and register the required information. Then click “OK”.

After entering information, click “OK”. Dial-up is created.

See page 10 for using “mopera U” or “mopera”.

See page 11 for using a provider other than “mopera U” or “mopera”.

#### Information

- The access point name (APN) is information to be registered in the FOMA phone, so if you connect another FOMA phone, you need to register the access point name (APN) again.
- To continue using the access point name (APN) of the personal computer, register the same access point name (APN) for the same cid number in the FOMA phone.

## Setting Dial-up Network

### Set Packet Communication

The operation below explains how to set a connection for packet communication without using the “FOMA PC setup software”.

The packet communication uses AT commands to carry out the settings from a personal computer. To specify settings, communication software to enter AT command is required. “Hyper Terminal”, which is attached to Windows as the standard software, is used here for explanation.

When using DOCOMO Internet access service “mopera U” or “mopera”, you do not need to set an access point name (APN) (see page 18).

You can set “caller ID notified/not notified” (see page 20) as required. (You need to set “caller ID notified” when using “mopera U” or “mopera”.)

<Packet communication setting flow using AT commands>

Confirm the COM port number (See page 18)

Start the communication software that enables the entry of AT commands  
(See step 3 of “Set an Access Point Name (APN)” on page 18)

Set an access point name (APN) (See step 7 on page 19)

Set “caller ID notified/not notified”  
(See step 2 on page 20)

Set others (See page 44)

Exit the communication software (See step 9 on page 20)

#### ■ AT commands

- The AT commands are used to control a modem. The FOMA phone, which conforms to the AT commands, supports some extended commands and unique AT commands.
- By entering AT commands, you can carry out detailed setting for packet communication and FOMA phone, and confirm (display) the setting contents.
- If the entered AT command is not displayed, enter “ATE1 [ ]”.

## Confirm COM Port Number

To manually carry out the communication setting, you need to specify a COM port number, which is assigned to “FOMA P706iμ” (modem) embedded after you install the “FOMA communication setup files” (driver). The confirmation method varies depending on the operating system of your personal computer.

- When using DOCOMO Internet access service “mopera U” or “mopera”, you do not need to set an access point name (APN); therefore, you do not need to confirm the modem.

### For Windows XP

- 1 “スタート (Start)” ▶ Open “コントロールパネル (Control panel)”.
- 2 From “プリンタとその他のハードウェア (Printer and the other hardware)” in “コントロールパネル (Control panel)”, open “電話とモデムのオプション (Phone and modem options)”.
- 3 If the “所在地情報 (Address information)” display appears, enter “市外局番/エリアコード (City code/Area code)”, then click “OK”.
- 4 Open the “モデム (Modem)” tab, confirm the COM port number in the “接続先 (Access point)” field of “FOMA P706iμ”, then click “OK”.

- The COM port number you confirmed is used to set an access point name (APN) (see page 18).
- The contents on the property display and COM port number vary depending on the personal computer you use.



### For Windows 2000

- 1 “スタート (Start)” ▶ “設定 (Setting)” ▶ Open “コントロールパネル (Control panel)”.
- 2 Open “電話とモデムのオプション (Phone and modem options)” in “コントロールパネル (Control panel)”.
- 3 If the “所在地情報 (Address information)” display appears, enter “市外局番 (City code)”, then click “OK”.

- 4 Open the “モデム (Modem)” tab, confirm the COM port number in the “接続先 (Access point)” field of “FOMA P706iμ”, then click “OK”.

- The COM port number you confirmed is used to set an access point name (APN) (see page 18).
- The contents on the property display and COM port number vary depending on the personal computer you use.



## Set an Access Point Name (APN)

The operation below explains how to set an access point name (APN) for packet communication. You can register up to 10 access point names (APNs), which are managed with cid1 to cid10 (see page 20).

When using “mopera U” or “mopera”, you do not need to set the access point name (APN).

The operation below is the example where you use “XXX.abc” as the access point name (APN) and use the FOMA USB Cable with Charge Function 01/02 (option). For the actual access point name (APN), contact your Internet service provider or network administrator. The setting here will be the access point number for dial-up network setting (see page 21).

### For Windows XP

- 1 Connect the FOMA USB Cable with Charge Function 01/02 to the FOMA phone.
- 2 Turn on the power to the FOMA phone, then connect the FOMA USB Cable with Charge Function 01/02, which is already connected to the FOMA phone, to the personal computer.
- 3 Start Hyper Terminal.

“スタート (Start)” → “すべてのプログラム (All programs)” → “アクセサリ (Accessories)” → “通信 (Communications)” → Open “ハイパーターミナル (Hyper Terminal)”.

After starting Hyper Terminal, when the message “『既定のTelnetプログラムにしますか? (Select the specified Telnet program?)』” is displayed, set as desired. Contact the maker of your personal computer and Microsoft Corporation for the setting contents.

- For Windows 2000, “スタート (Start)” → “プログラム (Programs)” → “アクセサリ (Accessories)” → “通信 (Communications)” → Open “ハイパーターミナル (Hyper Terminal)”.

## 4 Enter any name in the “名前 (Name)” field, then click “OK”.

Here, “Sample” is entered as an example.



## 5 Select the connection method.

<When you can select the COM port number of “FOMA P706iμ”>

Select the COM port number with which you install the “FOMA P706iμ” in the “接続方法 (Connection method)” field, then click “OK”. Then, go to step 6.

- Here, “COM3” is selected as an example. See page 18 for the COM port number of “FOMA P706iμ”, you should actually select in the “接続方法 (Connection method)” field.



<When you cannot select the COM port number of “FOMA P706iμ”>

- Click “キャンセル (Cancel)” to close the “接続の設定 (Set a connection)” display, then perform the following operations:
- (1) “ファイル (File)” menu→Select “プロパティ (Properties)”.
  - (2) Select “FOMA P706iμ” in the “接続方法 (Connection method)” field of the “接続の設定 (Set a connection)” tab on the “Sample”の プロパティ (Sample properties) display.
  - (3) Uncheck “国/地域番号と市外局番を使う (Use country/region code and city code)”.
  - (4) Click “OK”.

Then, go to step 7.



## 6 The properties of the COM port number appear on the display, then click “OK”.

- This display appears when you select a COM port number in step 5.

## 7 Set an access point name (APN).

Enter an access point name (APN) in the following format:

AT+CGDCONT = cid, “PDP\_type”, “APN”  
cid: Enter 2 or any number from 4 through 10.

※If you have already specified cid, be careful that its contents are overwritten by the access point name you enter here.

“PDP\_type”: Enter “PPP” or “IP”.

“APN”: Enclose an access point name (APN) in double quotation marks (“”).

(Example: When specifying APN “XXX.abc” in cid2)

AT+CGDCONT=2,“PPP”,“XXX.abc”

Enter this character string, then press [Enter]. If “OK” appears, the APN setting is completed.

- To confirm the current APN setting, enter “AT+CGDCONT?” [Enter]. The set APNs are listed on the display.



## 8 Confirm that “OK” appears on the display.

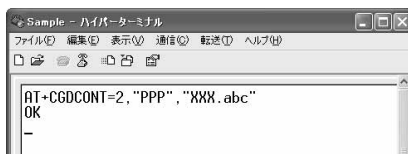

## 9 “ファイル (File)” menu ▶ Select “ハイパーターミナルの終了 (Exit Hyper Terminal)” to exit Hyper Terminal.

- If the message “現在、接続されています。切断してもよろしいですか? (Currently connected. Do you want to disconnect this line?)” appears, select “はい (Yes)”.
- The message “セッションXXXを保存しますか? (Do you want to save session XXX?)” then appears. You do not need to especially save that session.

### Information

- The access point name (APN) is information to be registered in the FOMA phone, so if you connect another FOMA phone, you need to register the access point name (APN) again.
- To continue using the access point name (APN) of the personal computer, register the same access point name (APN) for the same cid number in the FOMA phone.
- If the entered AT command is not displayed, enter “ATE1 

### ■cid (Registration number)

The FOMA phone has registration numbers, cid1 through cid10. cid1 contains “mopera.ne.jp” and cid3 contains “mopera.net” as an access point name (APN) by default. To connect to a provider other than “mopera U” or “mopera”, you need to set the access point name (APN) to one of cid2 or cid4 through cid10 as specified by the provider or network administrator.

#### Default cid contents

Registration No. (cid)	Access point name (APN)
1	mopera.ne.jp (mopera)
2	Not set
3	mopera.net (mopera U)
4 to 10	Not set

### ■“Phone number” for connecting to an access point name (APN) you register in cid

“\*99\*\*<cid No.>#”

(Example) When connecting to the access point name (APN) you register in cid2, enter the following:

\*99\*\*2#

### ■Resetting/Confirming the access point name (APN) settings

You can use AT commands to reset/confirm the access point name (APN) settings.

#### Resetting access point name (APN)

The access point name (APN) for cid=1 returns to “mopera.ne.jp” (default), and for cid=3 returns to “mopera.net” (default); the settings for cid=2 and cid=4 through cid10 are reset to being unregistered if you reset them.

(Entry method)

AT+CGDCONT= (When resetting all the cid contents)

AT+CGDCONT=<cid> (When resetting only a specific cid)

#### Confirming access point name (APN)

The currently specified access point name appears on the display.

(Entry method)

AT+CGDCONT?

## Set Caller ID Notified/Not Notified

For packet communication, you can specify whether to notify your caller ID (caller ID notified/not notified). The caller ID is your important information; so, take a great care to notify your caller ID. You can use AT commands (\*DGPIR command) to specify “caller ID notified/not notified” before dial-up connection.

### 1 Start the communication software such as “Hyper Terminal”.

- See page 18 for details on how to operate “Hyper Terminal”.

### 2 Use the \*DGPIR command (see page 46) to specify “caller ID notified/not notified”.

- To automatically add “184 (not notify)” for outgoing or incoming call, enter the following:  
AT\*DGPIR=1
- To automatically add “186 (notify)” for outgoing or incoming call, enter the following:  
AT\*DGPIR=2



### 3 Confirm that “OK” appears on the display.



### Information

- When using DOCOMO Internet access service “mopera U” or “mopera”, you need to set your caller ID to be “notified”.
- If the entered AT command is not displayed, enter “ATE1 

20

■Specifying “caller ID notified/not notified” in dial-up network  
 Also by dial-up network setting (see page 21), you can add “186 (notify)” or “184 (not notify)” to each access point number.  
 When you specify “186 (notify)” or “184 (not notify)” using both the \*DGPIR command and dial-up network setting, the caller ID is set as follows:

Dial-up network setting (cid = 3)	Caller ID notification setting by *DGPIR command	Notify/Not notify caller ID
*99**3#	Not set	Notify
	Not notify	Not notify
	Notify	Notify
184*99**3#	Not set	Not notify
	Not notify	(“184” specified in the dial-up network has a priority)
	Notify	
186*99**3#	Not set	Notify
	Not notify	(“186” specified in the dial-up network has a priority)
	Notify	

● To connect to “mopera U” or “mopera”, you need to notify your caller ID.

## Set Dial-up Network for Windows XP

- 1 “スタート (Start)” ▶ “すべてのプログラム (All programs)” ▶ “アクセサリ (Accessories)” ▶ “通信 (Communications)” ▶ Open “新しい接続ウィザード (New connection wizard)”.
- 2 When the “新しい接続ウィザード (New connection wizard)” display appears, click “次へ (Next)”.

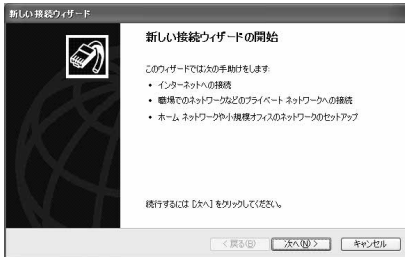

- 3 Select “インターネットに接続する (Connect to the Internet)”, then click “次へ (Next)”.
- 4 Select “接続を手動でセットアップする (Manually set up the connection)”, then click “次へ (Next)”.
- 5 Select “ダイヤルアップモデムを使用して接続する (Use a dial-up modem for connection)”, then click “次へ (Next)”.

- 6 If the “デバイスの選択 (Select a device)” display appears, check “FOMA P706iμ” only, then click “次へ (Next)”.

● The “デバイスの選択 (Select a device)” display appears only when you have registered two or more modems.



- 7 Enter any name in the “ISP 名 (ISP name)” field, then click “次へ (Next)”.

● Here, “SAMPLE” is entered as an example.



- 8 Enter an access point number in the “電話番号 (Phone number)” field, then click “次へ (Next)”.

● When connecting to “mopera U”, enter “\*99\*\*3#” as the access point number.  
 See page 20 for access point numbers other than “mopera U”.



**9** Enter the user name and password supplied from your Internet service provider or network administrator in the “ユーザー名 (User name)”, “パスワード (Password)” and “パスワードの確認入力 (Confirm the password)” fields. Then click “次へ (Next)”.

- When connecting to “mopera U” or “mopera”, you can leave the user name and password fields blank.

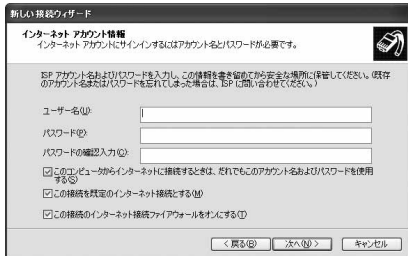

**10** Click “完了 (Complete)”.

**11** スタート (Start) ▶ “すべてのプログラム (All programs)” ▶ “アクセサリ (Accessories)” ▶ “通信 (Communications)” ▶ Open “ネットワーク接続 (Connect to network)”.

**12** Select the dial-up icon; then “ネットワークタスク (Network task)” ▶ Select “この接続の設定を変更する (Modify this connection setting)”.

Here, click the icon of the name you entered in step 7.

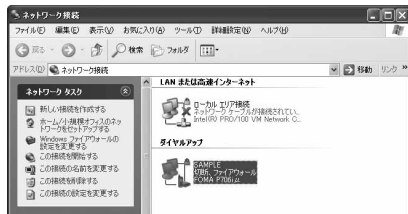

**13** Click the “全般 (General)” tab to confirm the setting contents.

When two or more modems are connected to your personal computer, confirm that “モデム (Modem) - FOMA P706iμ” is checked in the “接続方法 (Connection method)” field. If it is not checked, check it. If two or more modems are checked, click the button to position the priority level of “モデム (Modem) - FOMA P706iμ” to the top or uncheck modems other than “モデム (Modem) - FOMA P706iμ”.

When “ダイヤル情報を使う (Use dial information)” is checked, uncheck it.

- The COM port number allocated to “FOMA P706iμ” varies depending on the personal computer you use.

- When connecting to “mopera U”, enter “\*99\*\* \*3#” as the access point number.

See page 20 for access point numbers other than “mopera U”.



**14** Click the “ネットワーク (Network)” tab, then carry out respective settings.

In the “呼び出すダイヤルアップサーバーの種類 (Type of calling dial-up server)” field, select “PPP: Windows 95/98/NT4/2000, Internet”. In the “この接続は次の項目を使用します (Use the following items for this connection)” field, select “インターネットプロトコル (TCP/IP) [Internet protocol (TCP/IP)]”.

You cannot modify the setting of the “QoS パケットスケジューラ (QoS packet scheduler)” field; so use the default setting as it is. Next, click “設定 (Setting)”.

Contact your ISP (Internet service provider) or network administrator for how to set up TCP/IP to connect to a general ISP and so on.





15 Uncheck all the items, then click “OK”.



16 Return to the display in step 14, then click “OK”.

## Set Dial-up Network for Windows 2000

1 “スタート (Start)” ▶ “プログラム (Programs)” ▶ “アクセサリ (Accessories)” ▶ “通信 (Communications)” ▶ Open “ネットワークとダイヤルアップ接続 (Network and dial-up connections)”.

2 Double-click “新しい接続の作成 (Create a new connection)” in “ネットワークとダイヤルアップ接続 (Network and dial-up connections)”.



3 If the “所在地情報 (Address information)” display appears, enter “市外局番 (City code)”, then click “OK”.

- The “所在地情報 (Address information)” display appears only when you first start “新しい接続の作成 (Create a new connection)” in step 2.
- At the second time or after, the “ネットワークの接続ウィザード (Network connection wizard)” display appears instead of this display. Go to step 5.

4 When “電話とモデムのオプション (Phone and modem options)” appears, click “OK”.

5 When the “ネットワークの接続ウィザード (Network connection wizard)” display appears, click “次へ (Next)”.



6 Select “インターネットにダイヤルアップ接続する (Dial-up connect to the Internet)”, then click “次へ (Next)”.

7 Select “インターネット接続を手動で設定するか、またはローカルエリアネットワーク (LAN) を使って接続します [Connect to Internet manually or via the local area network (LAN)]”, then click “次へ (Next)”.

8 Select “電話回線とモデムを使ってインターネットに接続します (Connect to Internet via a phone line and modem)”, then click “次へ (Next)”.

9 Confirm that “FOMA P706iμ” is displayed in the “インターネットへの接続に使うモデムを選択する (Select a modem for connection to Internet)” field. Then click “次へ (Next)”.

- If “FOMA P706iμ” is not selected in that field, select it.
- The display below may not appear depending on the operating environment of your personal computer. In this case, go to step 10.



10 Enter an access point number in the “電話番号 (Phone number)” field.

- Leave the “市外局番 (City code)” field blank.
- Uncheck “市外局番とダイヤル情報を使う (Use city code and dial information)”.
- When connecting to “mopera U”, enter “\*99\*\*:\*3#” as the access point number. See page 20 for access point numbers other than “mopera U”.

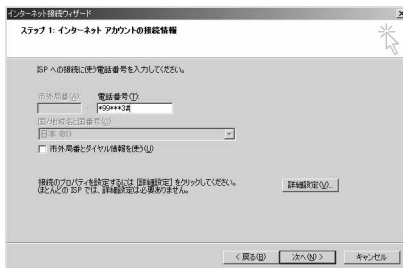

11 Click “詳細設定 (Detailed setting)”.



## 12 Specify the items in the “接続 (Connection)” tab.

Enter “接続の種類 (Connection type)” and “ログオンの手続き (Logon procedure)” according to the information supplied from your Internet service provider or network administrator. Confirm the contents you entered, then click the “アドレス (Address)” tab.

- Contact your Internet service provider or network administrator for the setting contents of “接続 (Connection)” tab.

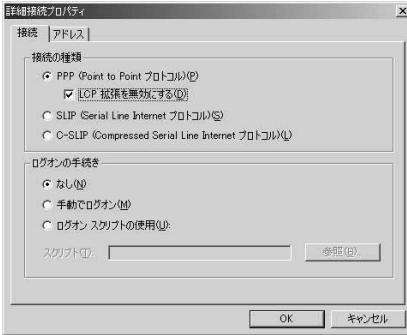

## 13 Specify IP address and DNS (domain name service) address.

Enter “IPアドレス (IP address)” and “ISPによるDNS (ドメインネームサービス) アドレスの自動割り当て (Automatically allocate a DNS (domain name service) address by ISP)” according to the information supplied from your Internet service provider or network administrator.

After you finish entering all the items, click “OK”. The display in step 10 returns; then click “次へ (Next)”.

- Contact your Internet service provider or network administrator for the setting contents of IP address and DNS address.

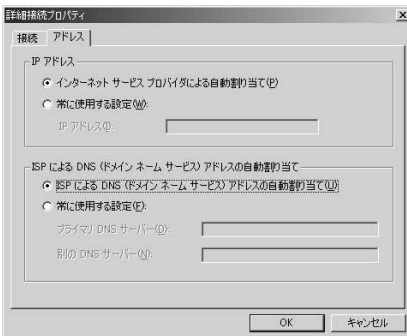

## 14 Enter the user name and password supplied from your Internet service provider or network administrator, in the “ユーザー名 (User name)” and “パスワード (Password)” fields. Then click “次へ (Next)”.

- When connecting to “mopera U” or “mopera”, you can leave the user name and password fields blank. In this case, two displays “ユーザー名を空白のままにしておきますか? (Do you want to make the user name blank?)” and “パスワードを空白のままにしておきますか? (Do you want to make the password blank?)” appear. Click “はい (Yes)” on each display. Then go to step 15.

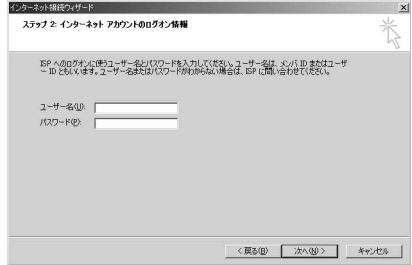

## 15 Enter any name in the “接続名 (Connection name)” field, then click “次へ (Next)”.

- Here, “SAMPLE” is entered as an example.

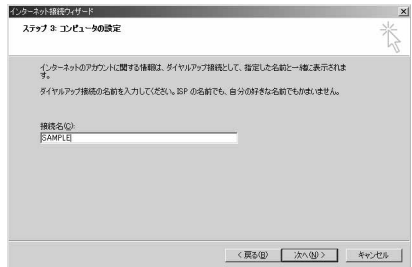

## 16 Select “いいえ (No)”, then click “次へ (Next)”.

- When setting the Internet mail, select “はい (Yes)”.
- Contact your Internet service provider or network administrator for details on the setting.

## 17 Then, carry out the “TCP/IP” setting.

- If the display below appears, uncheck “今すぐインターネットに接続するにはここを選び「完了」をクリックしてください (To connect to the Internet right now, select here, then click “Complete”)”. Then click “完了 (Complete)”.

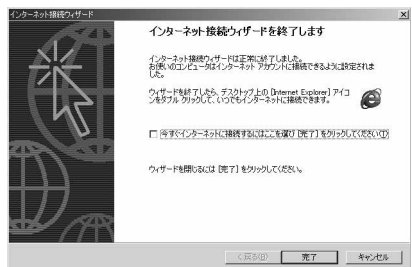

**18** “スタート (Start)” ▶ “プログラム (Programs)” ▶ “アクセサリ (Accessories)” ▶ “通信 (Communications)” ▶ Open “ネットワークとダイヤルアップ接続 (Network and dial-up connections)”.

**19** Select the icon of the access point name you entered in step 15; then “ファイル (File)” menu ▶ Select “プロパティ (Properties)”.



**20** Click the “全般 (General)” tab to confirm the setting contents.

- When two or more modems are connected to your personal computer, confirm that “モデム (Modem) - FOMA P706iu” is checked in the “接続の方法 (Connection method)” field. If it is not checked, check it.
- Confirm that “ダイヤル情報を使う (Use dial information)” is unchecked. If it is checked, uncheck it.
- The COM port number allocated to “FOMA P706iu” varies depending on the personal computer you use.
- When connecting to “mopera U”, enter “\*99\*\*\*3#” as the access point number.  
See page 20 for access point numbers other than “mopera U”.

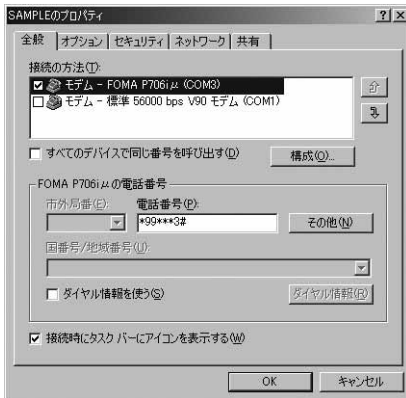

**21** Click the “ネットワーク (Network)” tab, then carry out respective settings.

In the “呼び出すダイヤルアップサーバーの種類 (Type of calling dial-up server)” field, select “PPP: Windows 95/98/NT4/2000, Internet”.

For the component, check only “インターネットプロトコル (TCP/IP) [Internet protocol (TCP/IP)]”.

Then click “設定 (Setting)”.

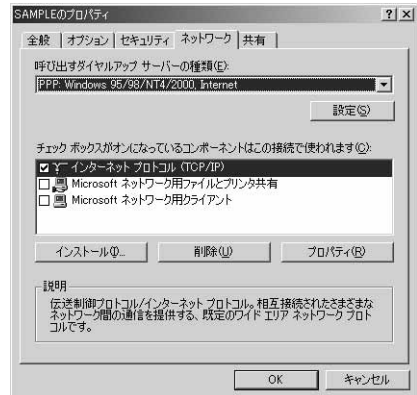

**22** Uncheck all the items, then click “OK”.



**23** Return to the display in step 21, then click “OK”.

## Making Dial-up Connection

The operation below explains how to make a dial-up connection using Windows XP as an example. Perform the operation on page 3 to connect the FOMA phone to your personal computer.

- To perform a connection via packet communication, it is recommended that you optimize the communication performance by “Communication Setup Optimization” on page 15. By optimizing data, you can maximize the high-speed communication capability in the FOMA network. To execute the optimization, install “FOMA PC setup software” (see page 7).
- When you perform 64K data communication, do not optimize the communication performance by “Communication setup optimization”.

**1** “スタート (Start)” ▶ “すべてのプログラム (All programs)” ▶ “アクセサリ (Accessories)” ▶ “通信 (Communications)” ▶ Open “ネットワーク接続 (Network connection)”.

## 2 Open the access point to be used.

Select the access point icon of the ISP name (see page 21) you specified in "Set Dial-up Network", then "ネットワークタスク (Network task)" → "この接続を開始する (Start this connection)". Otherwise, double-click the access point icon.



## 3 Confirm the contents and click "ダイヤル (Dial)".

- When connecting to "mopera U" or "mopera", you can leave the user name and password fields blank.

## 4 The display appears to indicate the connecting state.

In this period, the system performs logon processing to confirm the user name and password.



## 5 The connection is completed.

After the connection is completed, the message below appears from the indicator of the task bar for a few seconds.

- You can start the browser software to browse web pages, use e-mail and so on.
- If this message does not appear, confirm the setting of the access point again.



### Information

- Use the FOMA phone with the dial-up setting completed for dial-up connection. To connect another FOMA phone, you may need to reinstall the FOMA communication setup files (driver).
- The power consumption of the FOMA phone increases during communication.
- During packet communication, the communication state appears on the FOMA phone.
  - "☞" (Communicating, data sending)
  - "☜" (Communicating, data receiving)
  - "☞☜" (Communicating, no data sending/receiving)
  - "☞☞" (Outgoing or being disconnected)
  - "☜☜" (Incoming or being disconnected)
- During 64K data communication, "☞☜" appears on the FOMA phone.



## Disconnecting

### 1 Click the dial-up icon on the task tray.



### 2 Click "切断 (Disconnect)".

### Information

- The communication line may not be disconnected by only exiting the browser software. To surely disconnect the communication line, perform this operation.
- The baud rate displayed on your personal computer may be different from the actual one.

## When you cannot connect to network

If you cannot connect to network (if you fail a dial-up connection), confirm the following items:

If this error occurs	Confirm those:
Your personal computer cannot recognize "FOMA P706ij"	<ul style="list-style-type: none"> <li>Confirm whether your personal computer satisfies the operating environment (see page 2).</li> <li>Confirm whether "FOMA communication setup files" (driver) is installed in your personal computer.</li> <li>Confirm whether the FOMA phone is connected to your personal computer and powered on.</li> <li>Confirm whether the FOMA USB Cable with Charge Function 01/02 (option) is securely connected.</li> </ul>
You cannot connect to the access point	<ul style="list-style-type: none"> <li>Confirm whether the ID (user name) and password are correct.</li> <li>When you need to notify your caller ID such as when using "mopera U" or "mopera", make sure "184" is not prefixed to the phone number.</li> <li>Confirm that "フロー制御を使う (Use the flow control)" is checked in the modem properties.</li> <li>If you cannot connect to the access point even after confirming above, contact your Internet service provider or network administrator for the setting method, and so on.</li> </ul>

## Set 64K Data Communication

The operation below explains how to set the 64K data communication without using “FOMA PC setup software”.

### Setting dial-up connection and TCP/IP

The setting of dial-up connection and TCP/IP for the 64K data communication is the same as for the packet communication (see page 17).

Take care of the following points:

- In the 64K data communication, you do not need to set an access point name (APN). For the access point of the dial-up connection, enter the phone number of the access point specified by your Internet service provider or network administrator. (To connect to “mopera U”, enter “\*8701” in the phone number field. To connect to “mopera”, enter “\*9601” in the phone number field.)
- Set “caller ID notified/not notified” and “others” as required. (When connecting to “mopera U” or “mopera”, you need to notify your caller ID.)
- Contact your Internet service provider or network administrator for details on the setting contents.

### Connecting and Disconnecting

You can operate in the same way as for the packet communication. Perform the operations on page 14 or page 25.

## Using FirstPass PC Software

The FirstPass PC software is to access the FirstPass site from the web browser of your personal computer using the user certificate obtained by the FOMA phone supporting FirstPass.

## Notes for Installing FirstPass PC Software

### Confirm the operating environment

Use the FirstPass PC software under the following operating environment:

Item	Required environment
PC main unit	PC/AT compatible model
OS	Windows 2000, Windows XP (Japanese version in each)
Memory requirements	Windows 2000: 32 Mbytes or more* Windows XP: 128 Mbytes or more*
Hard disk space size	Unused memory space of 10 Mbytes or more*
Browser	Microsoft® Internet Explorer 5.5 or higher Microsoft® Internet Explorer 6.0 or higher when using Windows XP

\*The memory requirements and hard disk space size may vary depending on the system environment.

### Before installing

See “FirstPassManual” (PDF format) in the “FirstPassPCSoft” folder of the CD-ROM before installing the FirstPass PC software.

## Install FirstPass PC Software

The explanation here uses the displays for when installing the FirstPass PC software on Windows XP. The displays are slightly different depending on the personal computer you use.

- 1 Set the provided “FOMA P706iμ CD-ROM” into your personal computer.
- 2 To install the FirstPass PC software, click “データリンクソフト・各種設定ソフト (Data link software/Setup software)”.



- 3 Click “インストール (Install)” under “FirstPass PCソフト (FirstPass PC software)”.

Then, perform the operations described in “簡易操作マニュアル (Easy operation manual)” (PDF format).

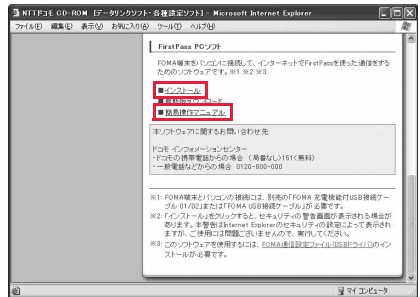

When you click “インストール (Install)”, an alert message might appear in the screen as shown below. This alert message appears depending on the security settings of Internet Explorer, but you can use your computer without any problem.

- When the “ファイルのダウンロード - セキュリティの警告 (File download - Security alert)” window appears: Click “実行 (Execute)”.

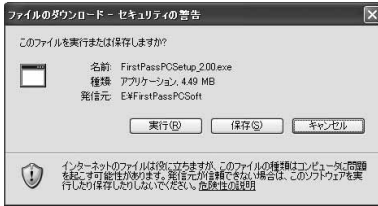

- When the “Internet Explorer - セキュリティの警告 (Internet Explorer - Security alert)” window appears: Click “実行する (Execute)”.

- “不明な発行者 (Unknown publisher)” is displayed in the “発行者 (Publisher)” field, but this is not a problem.

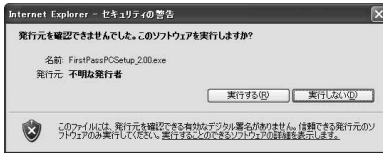

## For Using Windows Vista

### Installing FOMA Communication Setup Files (Driver)

Installing the FOMA communication setup files (driver) is required when you connect the FOMA phone to your personal computer via the FOMA USB Cable with Charge Function 01/02 (option) for the first time.

- Operate as the user who has the PC administrator right.

- 1 Connect the FOMA phone and the FOMA USB Cable with Charge Function 01/02. (See page 3)
- 2 Start Windows, then set the provided “FOMA P706iμ CD-ROM” into the personal computer.

### 3 Click “データリンクソフト・各種設定ソフト (Data link software/Setup software)”.

- If this display appears during installation of the “FOMA communication setup files” (driver), close the display.

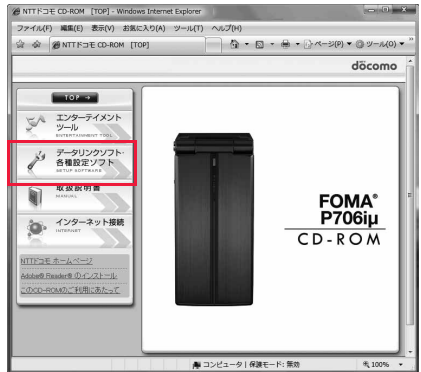

### 4 Click “インストール (Install)” under “FOMA通信設定ファイル (USBドライバ) [FOMA communication setup files (USB driver)]”.

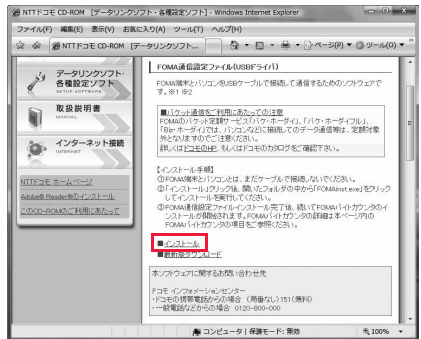

### 5 Double click “FOMInst.exe” in opened folder.

- Depending on the personal computer you use, the display to confirm the user account control might appear. In this case, click “許可 (Accept)” and continue the operation.

**6** Read “ソフトウェア使用許諾契約書 (Software licensing contract)”, and click “同意する (Agree)”.

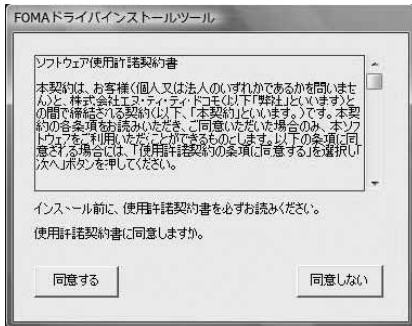

**7** Turn on the power to the FOMA phone, then connect the FOMA USB Cable with Charge Function 01/02, which is already connected to the FOMA phone, to the personal computer.

Installation starts.  
 Pop-up message “新しいハードウェアが見つかりました (New hardware was found)” appears for a few seconds from the indicator of the task bar.  
 After you complete the installation, pop-up message “デバイスを使用する準備ができました。デバイス ドライバソフトウェアが正しくインストールされました。(The system is ready to use the device. The device driver software was installed correctly.)” appears for a few seconds from the indicator of the task bar.

**8** Click “インストールする (推奨) [Installing (recommended)]”.

Then install the FOMA byte counter.  
 Install by following the onscreen instructions.  
 ● When you do not install the FOMA byte counter, go to step 9.

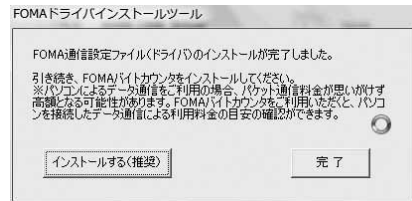

**9** Click “完了 (Complete)”.

Next, confirm that the “FOMA communication setup files” (driver) are installed correctly. (See page 29)

**Confirm Installed Driver**

Confirm that the “FOMA communication setup files” (driver) are installed correctly.

**1** “ [スタート (Start)]” ▶ Open “コントロールパネル (Control panel)” ▶ “システムとメンテナンス (System and maintenance)”

**2** Open “ハードウェアとデバイスを表示 (Show hardware and devices)” ▶ Click “続行 (Continue)”.

**3** Click each device, then confirm the installed driver names.

Confirm that all driver names are displayed under “ポート (COMとLPT) [Port (COM/LPT)]”, “モデム (Modem)”, and “ユニバーサル シリアルバス コントローラ (Universal serial bus controller)”.

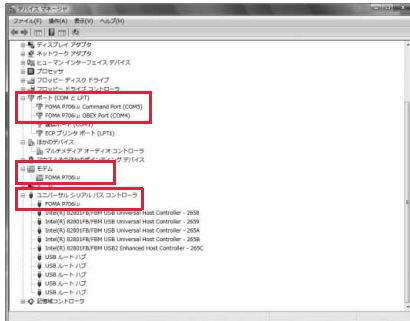

※The COM port number varies depending on the personal computer you use.

The following drivers are installed by installation of the “FOMA communication setup files” (driver):

Device name	FOMA communication setup file (driver) name
ポート (COMとLPT) [Port (COM/LPT)]	・ FOMA P706iμ Command Port ・ FOMA P706iμ OBEX Port
モデム (Modem)	・ FOMA P706iμ
ユニバーサル シリアルバス コントローラ (Universal serial bus controller)	・ FOMA P706iμ

To set an access point with the “FOMA PC setup software”, see page 31.  
 To set an access point without the “FOMA PC setup software”, see page 39 or page 42.

**Uninstall FOMA Communication Setup Files (Driver)**

When uninstalling the “FOMA communication setup files” (driver) is necessary (such as when upgrading the version), perform the operation below.

● Operate as the user who has the PC administrator right.

**1** If the FOMA phone is connected to a personal computer via the FOMA USB Cable with Charge Function 01/02 (option), disconnect the FOMA USB Cable with Charge Function 01/02.

**2** “ [スタート (Start)]” ▶ “コントロールパネル (Control panel)” ▶ Open “プログラムのアンインストール (Uninstall programs)”.

**3** Select “FOMA P706iμ USB” and click “アンインストールと変更 (Uninstall and change)” ▶ Click “続行 (Continue)”.

**4** Click “OK”.

**5** Click “はい (Yes)” to restart Windows.

The uninstallation is then completed.

- If you click “いいえ (No)”, restart it manually.

#### Information

- If you remove the FOMA USB Cable with Charge Function 01/02 from the personal computer while installing the “FOMA communication setup files” (driver) or click the “キャンセル (Cancel)” button to stop installation, the “FOMA communication setup files” (driver) may not be installed correctly. In this case, open “P706iμ\_USB\_Driver” → “Drivers” → “WinVista32” inside “FOMA P706iμ CD-ROM”, and execute “p706iuiun.exe” to delete the “FOMA communication setup files” (driver), and then install the files again.

## FOMA PC Setup Software

To connect the FOMA phone to a personal computer and perform the packet communication or 64K data communication, you need to configure various settings related to the communication. Using the “FOMA PC setup software”, you can easily carry out the settings below. If required, you can set the packet communication and 64K data communication without using the “FOMA PC setup software”. (See page 39 and page 42)

#### ■ Easy setting

You can easily carry out “dial-up creation for FOMA data communication” by following the guidance.

#### ■ Access point name (APN) setting

You can set an access point name (APN) required for packet communication.

The FOMA packet communication does not use an ordinary phone number as an access point unlike the 64K data communication.

You need to register an access point name (APN) in the FOMA phone in advance, and specify the registration number (cid) in the access point number field for connection.

By the default, “mopera.ne.jp”, the access point name (APN) of “mopera”, is registered in cid\*1, and “mopera.net”, that of “mopera U”, is registered in cid\*3. To connect to another service provider or Intranet LAN, however, you need to set the access point name (APN).

※“cid” is the abbreviation of “Context Identifier”, the number for storing the packet communication access point (APN) to the FOMA phone.

#### Information

- If the old-version “FOMAデータ通信設定ソフト (FOMA data communication setup software)” or the older version than this “FOMA PC設定ソフト (FOMA PC setup software)” (older than version 4.0.0) is installed, uninstall it in advance.

## Communication Setting by FOMA PC Setup Software

### STEP1 Install Software

#### Install the “FOMA PC setup software”.

See page 31 for installation.

If the older version than this “FOMA PC setup software” (version 4.0.0) is already installed, you cannot install this “FOMA PC setup software”, so uninstall it in advance. See page 32 if the display appears to indicate that the old-version “FOMAデータ通信設定ソフト (FOMA data communication setup software)” is installed.

### STEP2 Prepare for Setup

#### Prepare for setup.

Before setup, confirm that the FOMA phone is connected to your personal computer and correctly recognized by the personal computer. See page 3 for how to connect the FOMA USB Cable with Charge Function 01/02 (option).

If the FOMA phone is not correctly recognized by the personal computer, you cannot carry out settings and communication. See page 29 for confirming whether the FOMA phone is correctly recognized by the personal computer.

See page 28 through page 30 for how to install the “FOMA communication setup files” (driver).

### STEP3 Setting Operation

#### Carry out the appropriate setting for the communication you use.

Setting the packet communication from “Easy Setting”

When using “mopera U” or “mopera” as an access point  
..... page 33

When using a provider other than “mopera U” or “mopera”  
..... page 34

Setting the 64K data communication from “Easy Setting”

When using “mopera U” or “mopera” as an access point  
..... page 35

When using a provider other than “mopera U” or “mopera”  
..... page 36

See page 38 for setting an access point name (APN).

### STEP4 Connection

#### Connect to the Internet.



## Installing FOMA PC Setup Software

To connect the FOMA phone to a personal computer and perform the packet communication or 64K data communication, you need to configure various settings related to the communication.

Using the "FOMA PC setup software", you can easily set up dial-up and access point name (APN).

- Operate as the user who has the PC administrator right.

## Notes for Installing FOMA PC Setup Software

### Confirm that the FOMA phone is correctly recognized by your personal computer

Before installing the "FOMA PC setup software", you need to register the "FOMA communication setup files" (driver) correctly on the device of the personal computer. (See page 29)

#### ■When you connect the FOMA phone to your personal computer for the first time

The wizard shown below starts.

To use the FOMA data communication, you need to register the FOMA phone in your personal computer as a communication device.

See page 28 through page 30 for installation of the "FOMA communication setup files" (driver).



## Install FOMA PC Setup Software

The displays are slightly different depending on the personal computer you use.

- 1 Set the provided "FOMA P706iμ CD-ROM" into your personal computer.

- 2 To install the "FOMA PC setup software", click "データリンクソフト・各種設定ソフト (Data link software/Setup software)".

- If this display appears during installation of the "FOMA PC setup software", close the display.

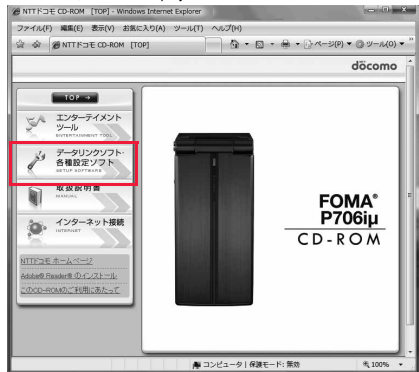

- 3 Click "インストール (Install)" under "FOMA PC 設定ソフト (FOMA PC setup software)".



When you click "インストール (Install)", an alert message might appear in the screen as shown below. This alert message appears depending on the security settings of Internet Explorer, but you can use your computer without any problem.

- When the "ファイルのダウンロード - セキュリティの警告 (File download - Security alert)" window appears: Click "実行 (Execute)".

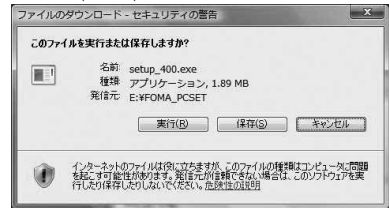

- When the "Internet Explorer - セキュリティの警告 (Internet Explorer - Security alert)" window appears: Click "実行する (Execute)".
- "不明な発行者 (Unknown publisher)" is displayed in the "発行元 (Publisher)" field, but this is not a problem.

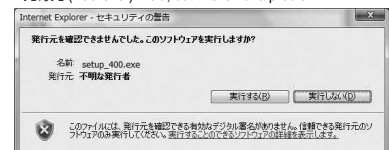

- When the display to confirm the user account control appears: Click "許可 (Accept)" and continue the operation.



## 4 Click “はい (Yes)”▶Click “次へ (Next)”.

Before starting setup, check that no other programs are currently running. If any program is running, click “キャンセル (Cancel)” to save and exit the program, then restart installation.

● See page 32 if the display appears to indicate that the old-version “FOMAデータ通信設定ソフト (FOMA data communication setup software)” or old-version “FOMA PC設定ソフト (FOMA PC setup software)” is installed.

## 5 Confirm the displayed contract contents.

If you agree with the contents, click “はい (Yes)”.

## 6 Confirm the installation destination, then click “次へ (Next)”.

To change the installation destination, click “参照 (Browse)”; specify any installation destination; then click “次へ (Next)”.

(You can install the FOMA PC setup software in a different drive, however, proceed without changing unless you have a problem on hard disk space, etc.)



## 7 Confirm the program folder name, then click “次へ (Next)”.

To change the program folder name, enter a new one, then click “次へ (Next)”.



## 8 Click “完了 (Complete)”.

After setup is completed, the “FOMA PC setup software” operation display appears.

### ■Displays at installation of the “FOMA PC setup software”

When the old-version “FOMAデータ通信設定ソフト (FOMA data communication setup software)” is installed

A warning display appears.

From “プログラムのアンインストール (Uninstall programs)”, uninstall the old-version “FOMAデータ通信設定ソフト (FOMA data communication setup software)”.

When you click “キャンセル (Cancel)” during the installation

A confirmation display appears when you click “キャンセル (Cancel)” or “いいえ (No)” during the setup operation. To continue the installation, click “いいえ (No)”. To intentionally cancel, click “はい (Yes)” and “完了 (Complete)”.

### ■Checking the version information about “FOMA PC setup software”

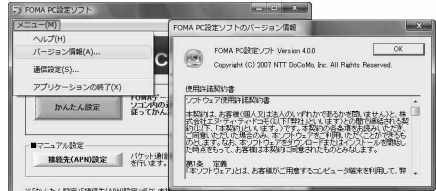

Select “メニュー (Menu)”→“バージョン情報 (Version information)” from the menu of the “FOMA PC setup software”.

The version information about the “FOMA PC setup software” is displayed.

## Setting Communication

The operation below explains how to carry out various settings related to the packet communication and 64K data communication.

There are “auto setting” for easy operation and “manual setting” for the user familiar with personal computers. Before setting, confirm that the FOMA phone is connected to your personal computer.

## 1 “[スタート (Start)]”▶“すべてのプログラム (All programs)”▶“FOMA PC設定ソフト (FOMA PC setup software)”▶Open “FOMA PC設定ソフト (FOMA PC setup software)”.

Using this PC setup software, you can easily create FOMA dial-up setting by answering (selecting and entering) the displayed questions according to “the information of connected provider” and “connection method” you selected.

- See page 33 for setting the packet communication from “かんたん設定 (Easy Setting)”.
- See page 35 for setting the 64K data communication from “かんたん設定 (Easy Setting)”.
- See page 38 for setting “接続先 (APN) 設定 [access point name (APN) setting]”.

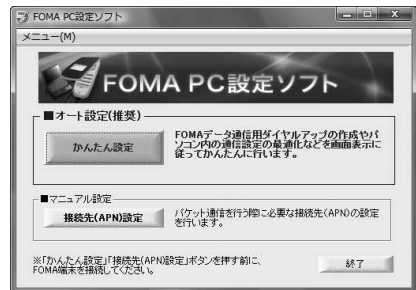

## Specify Communication Port

### 1 “メニュー (Menu)” of “FOMA PC setup software” ▶ Select “通信設定 (Communication setup)”.

- 自動設定 (推奨) [Auto-setup (recommended)]  
The connected FOMA phone is automatically specified. Usually, select “Auto-setup”.
  - COMポート指定 (Specifying COM port)  
When specifying a COM port number, specify the COM port number (COM1 through 99) the FOMA phone is connected to.
- See page 39 for how to check the COM port number.

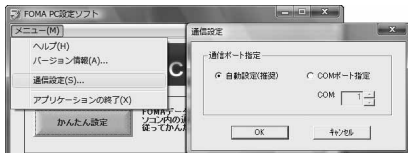

### 2 Click “OK”.

The settings are applied.

## Select Packet Communication from “かんたん設定 (Easy Setting)”

### Using “mopera U” or “mopera” as an access point

This section explains how to make settings for a high-speed packet communication of 3.6 Mbps maximum. This setting is for when you use DOCOMO Internet connection service “mopera U” or “mopera” as a provider.

High-speed packet communication:

You are charged according to the amount of data sent/received. You can execute data communication without worrying about time.

High-speed packet communication of up to 3.6 Mbps for receiving and up to 384 kbps for sending is available.

Note that a communication fee becomes expensive if you send/receive a large amount of data such as by browsing web pages having many images, or by downloading the data.

- The communication speed for both sending and receiving is up to 384 kbps for “mopera” connection.

### 1 Click “かんたん設定 (Easy Setting)”.

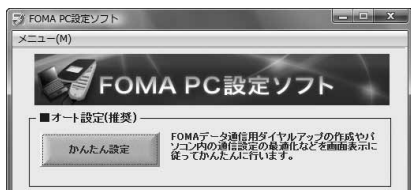

### 2 Select “パケット通信 (Packet communication)”, then click “次へ (Next)”.

Confirm that “パケット通信 (Packet communication)” is checked, then click “次へ (Next)”.

### 3 Select “『mopera U』への接続 (Connect to mopera U)” or “『mopera』への接続 (Connect to mopera)”, then click “次へ (Next)”.

To use “mopera U”, select “『mopera U』への接続 (Connect to mopera U)”. To use “mopera”, select “『mopera』への接続 (Connect to mopera)”. When “『mopera U』への接続 (Connect to mopera U)” is selected, the confirmation display appears asking whether you have signed up for it. If you have signed up, click “はい (YES)”.

- See page 34 for using a provider other than “mopera U” or “mopera”.

### 4 Click “OK”.

- The system obtains the access point name (APN) setting from the FOMA phone connected to the personal computer. Wait for a while.

### 5 Enter an access point name, then click “次へ (Next)”.

You can specify any name for the currently created connection. Enter a plain name in the “接続名 (Access point name)” field.

- You cannot enter the following half-pitch characters:  
¥, /, ;, \*, ?, !, <, >, |, and “.”
- You need to notify your caller ID for connecting to “mopera U” or “mopera”. Select “設定しない (推奨) [Not set (recommended)]” or “186を付加する (通知する) [Add 186 (notify)]”.
- For the setting of “発信者番号通知 (caller ID notification)”, select “設定しない (推奨) [Not set (recommended)]” for overseas use.
- “mopera U” supports connection types of both “PPP接続 (PPP connection)” and “IP接続 (IP connection)”. For overseas use, select “IP接続 (IP connection)”, “mopera” supports connection types of “PPP接続 (PPP connection)” only. “mopera” is not available overseas.

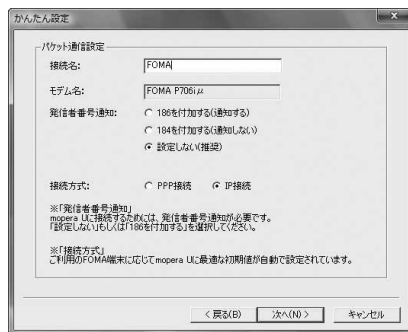

### 6 Click “次へ (Next)”.

If the access point is “mopera U” or “mopera”, you can connect even if the “ユーザ名 (user name)” and “パスワード (password)” fields are blank.

### 7 Confirm the set information, then click “完了 (Complete)”.

The set contents are listed on the display. Confirm that there is no problem on the set contents, then click “完了 (Complete)”.

- To change the set contents, click “戻る (Back)”.
- If “デスクトップにダイヤルアップのショートカットを作成する (Create a dial-up shortcut on the desktop)” is checked, a dial-up shortcut will be created on the desktop.

### 8 Click “OK”.

The setting is completed.

Open the dial-up shortcut icon automatically created on the desktop; then the connection display for starting communications appears. After confirming that the connection starts, you can start the Internet browser or mail browser for communication. (See page 37)



## Using a provider other than “mopera U” or “mopera” as an access point

The packet communication is a communication system you are charged according to the amount of data you sent and received, regardless of the communication time and distance. (Maximum download speed: 3.6 Mbps, Maximum upload speed: 384 kbps)

To use a provider other than “mopera”, you may need to separately apply for the service and sign a contract with the provider.

### 1 Click “かんたん設定 (Easy Setting)”.

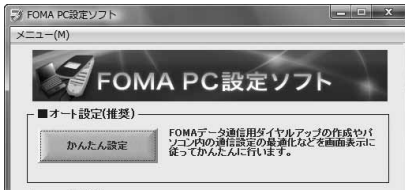

### 2 Select “パケット通信 (Packet communication)”, then click “次へ (Next)”.

Confirm that “パケット通信 (Packet communication)” is checked, then click “次へ (Next)”.

### 3 Select “その他 (Others)”, then click “次へ (Next)”.

Confirm that “その他 (Others)” is checked, then click “次へ (Next)”.

### 4 Click “OK”.

• The system obtains the access point name (APN) setting from the FOMA phone connected to the personal computer. Wait for a while.

### 5 Enter an access point name.

You can specify any name for the currently created connection. Enter a plain name in the “接続名 (Access point name)” field.

- You cannot enter the following half-pitch characters: ¥, /, :, \*, ?, !, <, >, |, and “”.
- In the “接続先 (APN) の選択 [Select an access point name (APN)]” field, “mopera.ne.jp [PPP接続] [mopera.ne.jp (PPP connection)]” is displayed as the default. Go to the “接続先 (APN) 設定 [Set an access point name (APN)]” display.
- For the setting of “発信者番号通知 (caller ID notification)”, follow the information from the provider and others. For overseas use, select “設定しない (Not set)”.



### 6 Click “接続先 (APN) 設定 [Set an access point name (APN)]”.

“mopera.ne.jp” is registered in “cid1” and “mopera.net” is registered in “cid3” by default. Click “追加 (Add)”, then enter the correct access point name (APN) for FOMA packet communication on the “接続先 (APN) の追加 [Add an access point name (APN)]” display. Click “OK”. The “パケット通信設定 (Packet communication setting)” display returns. Select the access point name (APN) you specified newly. If it is ok, click “OK”.

- For a provider access point name (APN) or supported connection types, contact your provider.

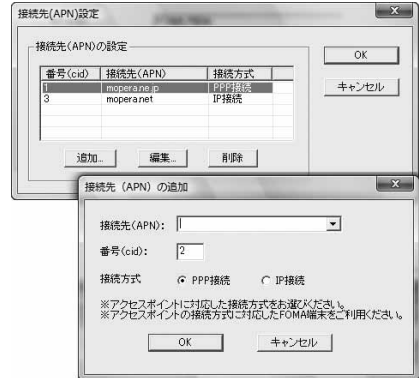

### 7 Click “詳細情報の設定 (Set detailed information)”.

The display for specifying “IPアドレス (IP address)” and “ネームサーバー (name server)” appears. When entering dial-up information for the provider you have subscribed or Intranet LAN system, specify addresses according to the entry instruction information, then click “OK”.

### 8 Click “次へ (Next)”.

### 9 Specify “ユーザー名 (User name)” and “パスワード (Password)”, then click “次へ (Next)”.

When specifying the user name and password, correctly enter the information supplied from your Internet service provider, taking care of the uppercase and lowercase letters and so on.

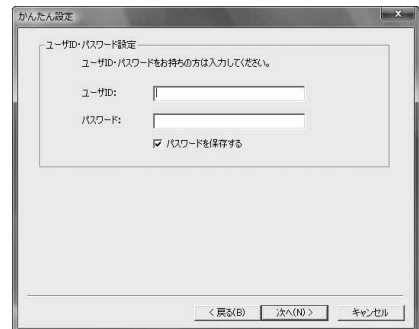

## 10 Confirm the set information, then click “完了 (Complete)”.

The set contents are listed on the display. Confirm that there is no problem on the set contents, then click “完了 (Complete)”.

- To change the set contents, click “戻る (Back)”.
- If “デスクトップにダイヤルアップのショートカットを作成する (Create a dial-up shortcut on the desktop)” is checked, a dial-up shortcut will be created on the desktop.

## 11 Click “OK”.

The setting is completed.

Open the dial-up shortcut icon automatically created on the desktop; then the connection display for starting communications appears. After confirming that the connection starts, you can start the Internet browser or mail browser for communication. (See page 37)



## Select 64K Data Communication from “かんたん設定 (Easy Setting)”

### Using “mopera U” or “mopera” as an access point

The 64K data communication is a communication system you are charged according to the duration of connection. (Maximum communication speed: 64 kbps) You can use the DOCOMO Internet access service, “mopera U”/“mopera”.

## 1 Click “かんたん設定 (Easy Setting)”.

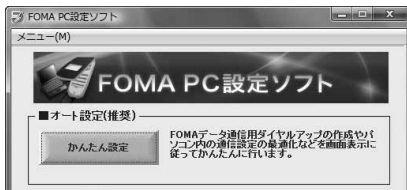

## 2 Select “64Kデータ通信 (64K data communication)”, then click “次へ (Next)”.

Confirm that “64Kデータ通信 (64K data communication)” is checked, then click “次へ (Next)”.

## 3 Select “『mopera U』への接続 (Connect to mopera U)” or “『mopera』への接続 (Connect to mopera)”, then click “次へ (Next)”.

To use “mopera U”, select “『mopera U』への接続 (Connect to mopera U)”. To use “mopera”, select “『mopera』への接続 (Connect to mopera)”. When “『mopera U』への接続 (Connect to mopera U)” is selected, the confirmation display appears asking whether you have signed up for it. If you have signed up, click “はい (YES)”.

- See page 36 for using a provider other than “mopera U” or “mopera”.

## 4 Enter an access point name, then click “次へ (Next)”.

You can specify any name for the currently created connection.

Enter a plain name in the “接続名 (Access point name)” field. Confirm that “FOMA P706ip” is displayed in the “モデムの選択 (Select a modem)” field.

- You cannot enter the following half-pitch characters: ¥, /, ;, \*, ?, !, <, >, |, and “”.
- Set whether to notify your caller ID for dial-up connection. You need to notify your caller ID for connecting to “mopera U” or “mopera”.

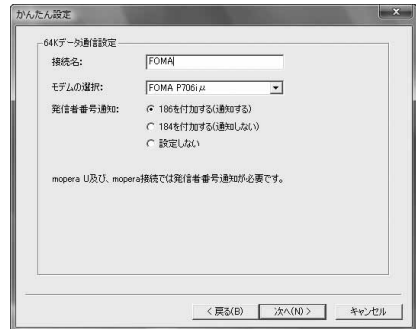

## 5 Click “次へ (Next)”.

If the access point is “mopera U” or “mopera”, you can connect even if the “ユーザ名 (user name)” and “パスワード (password)” fields are blank.

## 6 Confirm the set information, then click “完了 (Complete)”.

The set contents are listed on the display. Confirm that there is no problem on the set contents, then click “完了 (Complete)”.

- To change the set contents, click “戻る (Back)”.
- If “デスクトップにダイヤルアップのショートカットを作成する (Create a dial-up shortcut on the desktop)” is checked, a dial-up shortcut will be created on the desktop.

## 7 Click “OK”.

The setting is completed.

Open the dial-up shortcut icon automatically created on the desktop; then the connection display for starting communications appears. After confirming that the connection starts, you can start the Internet browser or mail browser for communication. (See page 37)



## Using a provider other than “mopera U” or “mopera” as an access point

The 64K data communication is a communication system you are charged according to the duration of connection. (Maximum communication speed: 64 kbps) To use a provider other than “mopera”, you may need to separately apply for the service and sign a contract with the provider.

### 1 Click “かんたん設定 (Easy Setting)”.

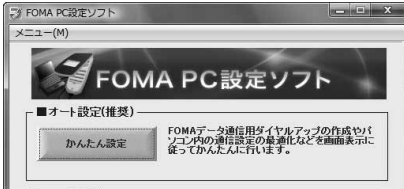

### 2 Select “64Kデータ通信 (64K data communication)”, then click “次へ (Next)”.

Confirm that “64Kデータ通信 (64K data communication)” is checked, then click “次へ (Next)”.

### 3 Select “その他 (Others)”, then click “次へ (Next)”.

Confirm that “その他 (Others)” is checked, then click “次へ (Next)”.

### 4 Enter dial-up information.

When connecting to a provider supporting ISDN-synchronous 64K other than “mopera U” or “mopera”, register the following items when creating the dial-up.

- ① “接続名 (Access point name)” (arbitrary)
- ② “モデムの選択 (Select a modem)” (FOMA P706ip)
- ③ “電話番号 (Phone number of provider access)”
- ④ Set whether to notify your caller ID for dial-up connection.

Correctly enter these items according to the provider information.

- For the setting of the caller ID notification, follow the instructions from the provider you use.
- You cannot enter the following half-pitch characters in the “接続名 (Access point name)” field: ¥, /, :, \*, ?, !, <, >, |, and “.”.

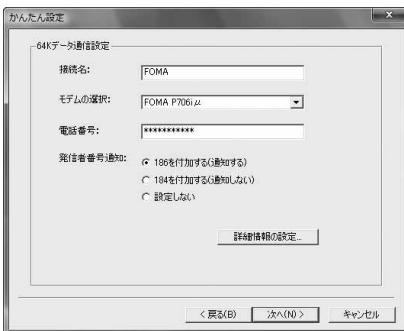

### 5 Click “詳細情報の設定 (Set detailed information)”.

The display for specifying “IPアドレス (IP address)” and “ネームサーバー (name server)” appears. When entering dial-up information for the provider you have subscribed or Intranet LAN system, specify addresses according to the entry instruction information, then click “OK”.

### 6 Click “次へ (Next)”.

### 7 Specify “ユーザー名 (User name)” and “パスワード (Password)”, then click “次へ (Next)”.

When specifying the user name and password, correctly enter the information supplied from your Internet service provider, taking care of uppercase and lowercase letters and so on.

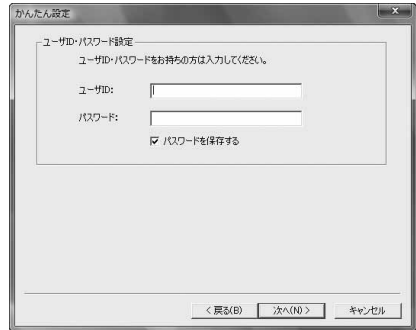

### 8 Confirm the set information, then click “完了 (Complete)”.

The set contents are listed on the display. Confirm that there is no problem on the set contents, then click “完了 (Complete)”.

- To change the set contents, click “戻る (Back)”.
- If “デスクトップにダイヤルアップのショートカットを作成する (Create a dial-up shortcut on the desktop)” is checked, a dial-up shortcut will be created on the desktop.

### 9 Click “OK”.

The setting is completed.

Open the dial-up shortcut icon automatically created

on the desktop; then the connection display for starting communications appears. After confirming that the connection starts, you can start the Internet browser or mail browser for communication. (See page 37)



## Carrying Out Set Communication

Perform the operation on page 3 to connect the FOMA phone to your personal computer.

### 1 “ [スタート (Start)]”

▶ Open “接続先 (Access point)”, select an access point and click “接続 (Connect)”.

- Open the FOMA connection shortcut icon created at communication setting; the connection display for starting communication appears. Bring up the icon by the following operations if it is not displayed:

 [スタート (Start)] → “コントロールパネル (Control panel)”  
→ “ネットワークとインターネット (Network and Internet)”  
→ “ネットワークと共有センター (Network and sharing center)”  
→ “ネットワーク接続の管理 (Management of network connection)”

### 2 Enter “ユーザー名 (User name)” and “パスワード (Password)”, then click “ダイヤル (Dial)”.

- For “mopera U” or “mopera”, you can connect even if the “ユーザー名 (User name)” and “パスワード (Password)” fields are blank.
- When you put a check mark for “次のユーザーが接続するとき使用するために、このユーザー名とパスワードを保存する (Save this user name and the password for the next user to use for connecting)”, this user or all users do not need to enter them from the next time.



### 3 Check for the connection, then click “閉じる (Close)”.

- You can start the browser software to browse web pages, use e-mail, and so on.



## Information

- Use the FOMA phone with the dial-up setting completed for dial-up connection. To connect another FOMA phone, you may need to reinstall the FOMA communication setup files (driver).
- The power consumption of the FOMA phone increases during communication.
- During packet communication, the communication state appears on the FOMA phone.

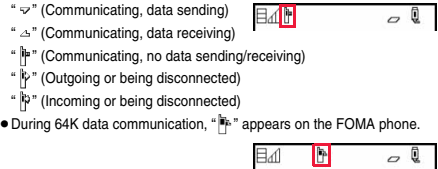

## Disconnecting

### 1 “ [スタート (Start)]”

▶ Open “接続先 (Access point)”.

### 2 Select the icon which is communicating, then click “切断 (Disconnect)”

▶ Click “閉じる (Close)”.

## Information

- The communication line may not be disconnected by only exiting the browser software. To surely disconnect the communication line, perform this operation.
- The baud rate displayed on your personal computer may be different from the actual one.

## Uninstalling FOMA PC Setup Software

### Before Uninstalling

Before uninstalling the “FOMA PC setup software”, reset the contents modified for the FOMA phone to the default.

### 1 Exit the currently running programs.

- Click “終了 (Exit)” at the bottom right to exit the “FOMA PC setup software”.
- If you try to uninstall during running of the “FOMA PC setup software”, the display below appears. Stop the uninstallation processing, and exit the program.

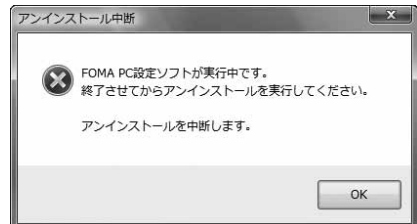



## Uninstall

The displays differ depending on the personal computer you use.

- Operate as the user who has the PC administrator right.

1 “ [スタート (Start)]”▶“コントロールパネル (Control panel)”▶Open “プログラムのアンインストール (Uninstall programs)”.

2 Select “NTT DoCoMo FOMA PC設定ソフト (NTT DoCoMo FOMA PC setup software)”, then click “アンインストール (Uninstall)”▶Click “続行 (Continue)”.



3 Click “はい (Yes)”.

The uninstallation starts, and applications (programs) are deleted.

4 Click “完了 (Finish)”.

Uninstalling the “FOMA PC setup software” is completed.

## Access Point Name (APN) Setting

The operation below explains how to set an access point name (APN) for packet communication. The FOMA packet communication does not use an ordinary phone number as an access point unlike the 64K data communication. For each access point, register an access point name (APN) in the FOMA phone beforehand, then specify the registration number (cid) in the access point phone number field for connection. “cid” is the abbreviation of “Context Identifier”, the number for storing the packet communication access point name (APN) in the FOMA phone.

1 Start the “FOMA PC設定ソフト (FOMA PC setup software)”, then click “接続先 (APN) 設定 [Access point name (APN) setting]” in “マニュアル設定 (Manual setup)”.

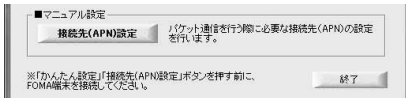

2 Click “OK”.

When you click “OK”, the system automatically accesses the connected FOMA phone and reads the registered “access point name (APN) setting”. You can obtain the setting information also from “ファイル (File)”→“FOMA端末から設定を取得 (Obtain the setting from the FOMA phone)” on the menu in step 3.

## 3 Set an access point name (APN).

- If the FOMA phone is not connected, this display does not appear.



Adding, editing, and deleting an access point name (APN)

- To add an access point name (APN), click “追加 (Add)”.
  - To edit (correct) a registered access point name (APN), click “編集 (Edit)”.
  - To delete a registered access point name (APN), select the target access point name (APN), then click “削除 (Delete)”.
- ※ You cannot delete the access point name (APN) registered in “cid1” and “cid3”. (Even if you select “cid3” and click “削除 (Delete)”, it is not deleted actually and “mopera.net” returns.)

Saving data into a file

From the menu, select “ファイル (File)”→“上書き保存 (Overwrite and save)” or “名前を付けて保存 (Rename and save)”; you can back up the access point name (APN) setting registered in the FOMA phone or save the currently edited access point name (APN) setting.

Reading data from a file

From the menu, select “ファイル (File)”→“開く (Open)”; you can obtain the access point name (APN) setting saved in the personal computer.

Reading access point name (APN) information from the FOMA phone

From the menu, select “ファイル (File)”→“FOMA端末から設定を取得 (Obtain the setting from the FOMA phone)”; you can obtain the access point name (APN) setting from the FOMA phone.

Writing access point name (APN) information to the FOMA phone

Click “FOMA端末へ設定を書き込む (Write the setting to the FOMA phone)”; you can write the displayed access point name (APN) setting to the FOMA phone.

You cannot write the IP information to the FOMA phone which does not support the IP connection.

Dial-up information creation function

Select an access point name you add or edit on the access point name (APN) setting display, then click “ダイヤルアップ作成 (Create dial-up information)”; you can create dial-up information for packet communication. If the access point name (APN) setting is not written to the FOMA phone, the FOMA phone setting writing confirmation display then appears, then click “はい (Yes)”. After writing ends, the “パケット通信ダイヤルアップ作成画面 (packet communication dial-up information creation display)” appears.

Enter any access point name, then click “ユーザID / パスワードの設定 (Specify user ID and password)”. (You can leave it blank to connect to “mopera U” or “mopera.”)

Enter the user name and password, select the authorized user, and then click “OK”.

If your Internet service provider instructs you to specify IP and DNS information, click “詳細情報の設定 (Set detailed information)”, and register the required information. Then click “OK”.

After entering information, click “OK”. Dial-up is created.

See page 33 for using “mopera U” or “mopera”.

See page 34 for using a provider other than “mopera U” or “mopera”.

## Information

- The access point name (APN) is information to be registered in the FOMA phone, so if you connect another FOMA phone, you need to register the access point name (APN) again.
- To continue using the access point name (APN) of the personal computer, register the same access point name (APN) for the same cid number in the FOMA phone.

## Setting Dial-up Network

### Set Packet Communication

The operation below explains how to set a connection for packet communication without using the “FOMA PC setup software”.

The packet communication uses AT commands to carry out the settings from a personal computer. To specify settings, communication software to enter AT command is required.

When using DOCOMO Internet access service “mopera U” or “mopera”, you do not need to set an access point name (APN) (See page 40).

You can set “caller ID notified/not notified” (see page 40) as required. (You need to set “caller ID notified” when using “mopera U” or “mopera”.)

<Packet communication setting flow using AT commands>

Confirm the COM port number



Start the communication software that enables the entry of AT commands



Set an access point name (APN)



Set “caller ID notified/not notified”



Set others



Exit the communication software

### ■AT commands

- The AT commands are used to control a modem. The FOMA phone, which conforms to the AT commands, supports some extended commands and unique AT commands.
- By entering AT commands, you can carry out detailed setting for packet communication and FOMA phone, and confirm (display) the setting contents.
- If the entered AT command is not displayed, enter “ATE1 [ ]”.

## Confirm COM Port Number

To manually carry out the communication setting, you need to specify a COM port number, which is assigned to “FOMA P706iμ” (modem) embedded after you install the “FOMA communication setup files” (driver). The confirmation method varies depending on the operating system of your personal computer.

- When using DOCOMO Internet access service “mopera U” or “mopera”, you do not need to set an access point name (APN); therefore, you do not need to confirm the modem.

- 1 “ [スタート (Start)]” ▶ Open “コントロールパネル (Control panel)”.
- 2 From “ハードウェアとサウンド (Hardware and sound)” in “コントロールパネル (Control panel)”, open “電話とモデムのオプション (Phone and modem options)”.
- 3 If the “所在地情報 (Address information)” display appears, enter “市外局番/エリアコード (City code/Area code)”, then click “OK”.
- 4 Open the “モデム (Modem)” tab, confirm the COM port number in the “接続先 (Access point)” field of “FOMA P706iμ”, then click “OK”.

- The COM port number you confirmed is used to set an access point name (APN) (see page 40).
- The contents on the property display and COM port number vary depending on the personal computer you use.
- Windows Vista does not support “Hyper Terminal”. For Windows Vista, set by using a software program which supports Windows Vista. (Follow the settings of the software program you use.)





## Set an Access Point Name (APN)

The operation below explains how to set an access point name (APN) for packet communication. You can register up to 10 access point names (APNs), which are managed with cid1 to cid10.

When using “mopera U” or “mopera”, you do not need to set the access point name (APN).

The operation below is the example where you use “XXX.abc” as the access point name (APN) and use the FOMA USB Cable with Charge Function 01/02 (option). For the actual access point name (APN), contact your Internet service provider or network administrator. The setting here will be the access point number for dial-up network setting (see page 40).

## Set Caller ID Notified/Not Notified

For packet communication, you can specify whether to notify your caller ID (caller ID notified/not notified).

The caller ID is your important information; so, take a great care to notify your caller ID. You can use AT commands (\*DGPIR command) to specify “caller ID notified/not notified” before dial-up connection.

## Set Dial-up Network

1 “ [スタート (Start)]”

▶ “接続先 (Access point)”

▶ Click “接続またはネットワークをセットアップします (Setup the connection or network)”.

2 Select “ダイヤルアップ接続をセットアップします (Setup the dial-up connection)”, then click “次へ (Next)”.



3 If the display for selecting a modem appears, click “FOMA P706iμ”.

- The display for selecting a modem appears only when you have registered two or more modems.

4 Enter any name in the “接続名 (Connection name)” field.

- Here, “SAMPLE” is entered as an example.

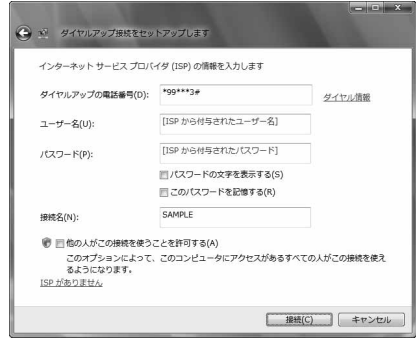

5 Enter an access point number in the “ダイヤルアップの電話番号 (Phone number for dial-up)” field.

- When connecting to “mopera U”, enter “\*99\*\*3#” as the access point number.

6 Enter the user name and password supplied from your Internet service provider or network administrator in the “ユーザー名 (User name)” and “パスワード (Password)” fields. Then click “接続 (Connect)”

▶ Click “スキップ (Skip)”.

- When connecting to “mopera U” or “mopera”, you can leave the user name and password fields blank.
- Only confirm the setting contents without connecting here.

7 Click “接続をセットアップします (Setup the connection)” ▶ Click “閉じる (Close)”.

8 “ [スタート (Start)]” ▶ “接続先 (Access point)” ▶ Highlight the access point which is finished with connection, and select “プロパティ (Property)” after the right click.

## 9 Click the “全般 (General)” tab to confirm the setting contents.

When two or more modems are connected to your personal computer, confirm that “モデム (Modem) - FOMA P706iμ” is checked in the “接続の方法 (Connection method)” field. If it is not checked, check it. If two or more modems are checked, click the  button to position the priority level of “モデム (Modem) - FOMA P706iμ” to the top or uncheck modems other than “モデム (Modem) - FOMA P706iμ”

When “ダイヤル情報を使う (Use dial information)” is checked, uncheck it.

- The COM port number allocated to “FOMA P706iμ” varies depending on the personal computer you use.
- When connecting to “mopera U”, enter “\*99\*\*\*3#” as the access point number.



## 10 Click the “ネットワーク (Network)” tab, then carry out respective settings.

In the “この接続は次の項目を使用します (Use the following items for this connection)” field, select “インターネットプロトコルバージョン4 (TCP/IPv4) [Internet protocol version 4 (TCP/IPv4)]”.

You can set the “QoS パケットスケジューラ (QoS packet scheduler)” if necessary.

Contact your ISP (Internet service provider) or network administrator for how to set up TCP/IP to connect to a general ISP and so on.



## 11 Click the “オプション (Option)” tab, then click “PPP設定 (PPP settings)”.

## 12 Uncheck all the items, then click “OK”.



## 13 Return to the display in step 10, then click “OK”.

## Making Dial-up Connection

Perform the operation on page 3 to connect the FOMA phone to your personal computer.

## 1 “スタート (Start)” ▶ Open “接続先 (Access point)”.

## 2 Select access point and click “接続 (Connect)”.



## 3 Confirm the contents and click “ダイヤル (Dial)”.

- When connecting to “mopera U” or “mopera”, you can leave the user name and password fields blank.

## 4 The display appears to indicate the connecting state.

In this period, the system performs logon processing to confirm the user name and password.



## 5 After the connection is completed, click “閉じる (Close)”.

- You can start the browser software to browse web pages, use e-mail and so on.



### Information

- Use the FOMA phone with the dial-up setting completed for dial-up connection. To connect another FOMA phone, you may need to reinstall the FOMA communication setup files (driver).
- The power consumption of the FOMA phone increases during communication.
- During packet communication, the communication state appears on the FOMA phone.

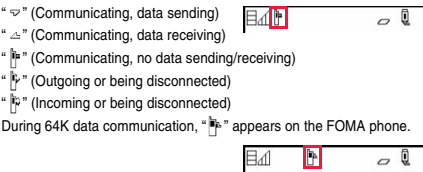

### Disconnecting

1 Click the dial-up icon on the task tray.



2 Select “接続または切断 (Connect or disconnect)”, then click “切断 (Disconnect)”  
▶ Click “閉じる (Close)”.

### Information

- The communication line may not be disconnected by only exiting the browser software. To surely disconnect the communication line, perform this operation.
- The baud rate displayed on your personal computer may be different from the actual one.

## When you cannot connect to network

If you cannot connect to network (if you fail a dial-up connection), confirm the following items:

If this error occurs	Confirm those:
Your personal computer cannot recognize “FOMA P706µ”	<ul style="list-style-type: none"> <li>• Confirm whether your personal computer satisfies the operating environment (see page 2).</li> <li>• Confirm whether “FOMA communication setup files” (driver) is installed in your personal computer.</li> <li>• Confirm whether the FOMA phone is connected to your personal computer and powered on.</li> <li>• Confirm whether the FOMA USB Cable with Charge Function 01/02 (option) is securely connected.</li> </ul>
You cannot connect to the access point	<ul style="list-style-type: none"> <li>• Confirm whether the ID (user name) and password are correct.</li> <li>• When you need to notify your caller ID such as when using “mopera U” or “mopera”, make sure “184” is not prefixed to the phone number.</li> <li>• Confirm that “フロー制御を使う (Use the flow control)” is checked in the modem properties.</li> <li>• If you cannot connect to the access point even after confirming above, contact your Internet service provider or network administrator for the setting method, and so on.</li> </ul>

## Set 64K Data Communication

The operation below explains how to set the 64K data communication without using “FOMA PC setup software”.

### Setting dial-up connection and TCP/IP

The setting of dial-up connection and TCP/IP for the 64K data communication is the same as for the packet communication (see page 39).

Take care of the following points:

- In the 64K data communication, you do not need to set an access point name (APN). For the access point of the dial-up connection, enter the phone number of the access point specified by your Internet service provider or network administrator. (To connect to “mopera U”, enter “\*8701” in the phone number field. To connect to “mopera”, enter “\*9601” in the phone number field.)
- Set “caller ID notified/not notified” and “others” as required. (When connecting to “mopera U” or “mopera”, you need to notify your caller ID.)
- Contact your Internet service provider or network administrator for details on the setting contents.

### Connecting and Disconnecting

You can operate in the same way as for the packet communication. Perform the operations on page 37 or page 41.

## Using FirstPass PC Software

The FirstPass PC software is to access the FirstPass site from the web browser of your personal computer using the user certificate obtained by the FOMA phone supporting FirstPass.

## Notes for Installing FirstPass PC Software

### Confirm the operating environment

Use the FirstPass PC software under the following operating environment:

Item	Required environment
PC main unit	PC/AT compatible model
OS	Windows Vista (Japanese version)
Memory requirements	512 Mbytes or more*
Hard disk space size	Unused memory space of 10 Mbytes or more**
Browser	Microsoft® Internet Explorer 7.0 or higher

\*The memory requirements and hard disk space size may vary depending on the system environment.

### Before installing

See “FirstPassManual” (PDF format) in the “FirstPassPCSoft” folder of the CD-ROM before installing the FirstPass PC software.

## Install FirstPass PC Software

The displays are slightly different depending on the personal computer you use.

- 1 Set the provided “FOMA P706iμ CD-ROM” into your personal computer.
- 2 To install the FirstPass PC software, click “データリンクソフト・各種設定ソフト (Data link software/Setup software)”.



## 3 Click “インストール (Install)” under “FirstPass PCソフト (FirstPass PC software)”.

Then, perform the operations described in “簡易操作マニュアル (Easy operation manual)” (PDF format).

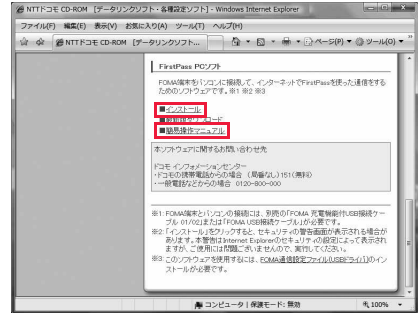

When you click “インストール (Install)”, an alert message might appear in the screen as shown below. This alert message appears depending on the security settings of Internet Explorer, but you can use your computer without any problem.

- When the “ファイルのダウンロード - セキュリティの警告 (File download - Security alert)” window appears:

Click “実行 (Execute)”.



- When the “Internet Explorer - セキュリティの警告 (Internet Explorer - Security alert)” window appears:

Click “実行する (Execute)”.

- “不明な発行者 (Unknown publisher)” is displayed in the “発行元 (Publisher)” field, but this is not a problem.

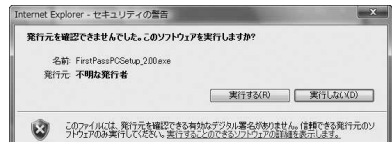

- When the display to confirm the user account control appears:

Click “許可 (Accept)” and continue the operation.

# Using AT Command

## AT Command

**AT commands are used to specify and modify the functions of the FOMA phone on the personal computer.**

※ The following abbreviations are used in the AT command list:

[AT]: Commands which are available at the FOMA P706iμ Command Port.

[M]: Commands which are available in the FOMA P706iμ (modem).

[&F]: Commands whose settings are initialized by the AT&F command.

[&W]: Commands whose settings are saved by the AT&W command. The set value can be recalled by the ATZ command.

### Information

- When you make a call from an external device or make an AT command call, the call is made from Number A in A Mode or Dual Mode of 2in1, and the call is made from Number B in B Mode of 2in1.

## Entry Format of AT Command

To enter an AT command, use the terminal mode display of the communication software. Be sure to enter half-pitch alphanumeric characters.

### • Entry example

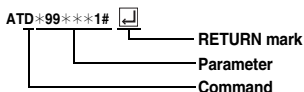

- You need to enter an AT command on one line, including a parameter (digits and symbols) which follows the command.

### Information

- The terminal mode enables you to operate a personal computer as one communication terminal. Using this mode, you can send characters you have entered from the keyboard to a line connected to the communication port.

## Switch between Online Data Mode and Online Command Mode

There are following two methods of switching the FOMA phone between the online data mode and online command mode:

- Enter the “+++” command or enter the code specified in the “S2” register.
- Set the ER signal of the RS-232C※ off when “AT&D1” is set.
- To switch the online command mode to the online data mode, enter “ATO”.

※ The RS-232C signal line, which is emulated via the USB interface, is controlled by a communication application.

### ■ Saving the setting contents

Please be careful that the setting contents with AT commands are initialized when the FOMA phone is turned off and on or the external device is removed, except for the access point name (APN) setting with the AT+CGDCONT command, QoS setting with the AT+CGEQMIN or AT+CGEQREQ command, incoming call acceptance/rejection setting with the AT+DGAPL, AT+DGARL, or AT+DGANSM command, phone number notification/no notification setting (for packet communication) with the AT+DGPIR command and caller ID notification restriction setting with the AT+CLIR command. For commands with [&W], you can enter “AT&W” (after setting) to save the setting contents and other set values with [&W] at the same time. If necessary, you can restore these set values by entering in “ATZ” even after the power is turned off and on.

## AT Command List

AT command	Outline	Parameter/Explanation	Command execution example
A/ [M]	Re-executes the last executed command. No carriage return is required.	—	A/ OK
AT%V [M]	Displays the version of the FOMA phone.	—	AT%V Ver1.00 OK
AT&Cn [M] [&F]&W]	Selects the operating conditions of the circuit CD signal sent to the DTE.	n=0: CD is always ON. n=1: CD varies according to the carrier of the other party's modem. (default)	AT&C1 OK
AT&Dn [M] [&F]&W]	Selects an operation to be performed when the circuit ER signal received from the DTE transits from ON to OFF.	n=0: Ignores the ER status. (Always assumed to be ON.) n=1: Sets the online command state when the ER changes from ON to OFF. n=2: Sets the offline command state when the ER changes from ON to OFF. (default)	AT&D1 OK
AT&En [M] [&F]&W]	Selects the speed display specification for connection.	n=0: Displays communication speed between radio wave blocks. n=1: Displays DTE serial communication speed. (default)	AT&E0 OK
AT&Fn [AT][M]	Returns all registers to the default. Performs line disconnection processing if you enter this command during communication.	Only n=0 is specifiable. (Can be omitted)	—
AT&Sn [M] [&F]&W]	Specifies the control of the data set ready signal to be output to the DTE.	n=0: DR is always ON. (default) n=1: DR is set to ON at connection of the line (at establishment of a communication call).	AT&S0 OK
AT&Wn [M]	Stores the current set values.	Only n=0 is specifiable. (Can be omitted)	—
AT* DANTE [AT][M]	Shows the number of antenna bars. (0 to 3)	=0: Antenna shows the out of the service area =1: Zero antenna bars or a single antenna bar =2: Two antenna bars =3: Three antenna bars	AT* DANTE * DANTE:3 OK AT* DANTE=? * DANTE:(0-3) OK
AT* DGANSM=n [M]	Sets the reject/accept setting mode for the packet incoming call. The setting with this command is valid for incoming calls in packet communication after you enter the setting command.	n=0: Invalidates the incoming call reject/accept setting. (default) n=1: Validates the incoming call reject setting (AT* DGARL). n=2: Validates the incoming call accept setting (AT* DGAPL). AT* DGANSM?: Displays the current setting.	AT* DGANSM=0 OK AT* DGANSM? * DGANSM:0 OK
AT* DGAPL=n [cid] [M]	Sets the APN of which packet incoming call is to be accepted. To specify the APN, use the <cid> parameter defined in AT+CGDCONT.	n=0: Adds the APN defined by <cid> to the incoming call accept list. n=1: Deletes the APN defined by <cid> from the incoming call accept list. Applied to all the cid contents if <cid> is omitted. AT* DGAPL?: Displays the incoming call accept list.	AT* DGAPL=0,1 OK AT* DGAPL? * DGAPL:1 OK AT* DGAPL=1 OK AT* DGAPL? OK
AT* DGARL=n [cid] [M]	Sets the APN of which packet incoming call is to be rejected. To specify the APN, use the <cid> parameter defined in +CGDCONT.	n=0: Adds the APN defined by <cid> to the incoming call reject list. n=1: Deletes the APN defined by <cid> from the incoming call reject list. Applied to all the cid contents if <cid> is omitted. AT* DGARL?: Displays the incoming call reject list.	AT* DGARL=0,1 OK AT* DGARL? * DGARL:1 OK AT* DGARL=1 OK AT* DGARL? OK

AT command	Outline	Parameter/Explanation	Command execution example
AT+*DGPIR=n  [M]	This command is valid at dialing/receiving calls. In the dial-up network setting, you can add "186" (notify) or "184" (not notify) to the phone number of the access point. (See page 20 or page 40)	n=0: Uses the APN as it is. (default) n=1: Adds "184" to the APN. (always not notify) n=2: Adds "186" to the APN. (always notify) AT+*DGPIR?: Displays the current setting.	AT+*DGPIR=0 OK AT+*DGPIR? *DGPIR:0 OK
AT+*DRPW  [AT][M]	Displays the output power index for receiving. (0: minimum value to 75: maximum value)	—	AT+*DRPW *DRPW:0 OK
+++  [M]	Changes to the online command state without disconnecting the line when the escape sequence is executed in the online mode.	—	—
AT+CAOC  [M]	Displays the charging information for now or latest call.	Result: +CAOC:"n" n: Displays the charging information in a hexadecimal number.	AT+CAOC +CAOC:'00001E' OK
AT+CBC  [M]	Displays the battery level.	Result: +CBC:n,m n=0: FOMA phone is powered by the battery. n=1: During charging n=2: The battery is not connected. n=3: Power-supply error m=0~100: Battery level	AT+CBC +CBC:0,80 OK
AT+CBST=n,1,0  [M] [&W][&F]	Sets the bearer service to be used.	n=116: 64000 bps (bit transparent) (default) n=134: 64000 bps (multimedia)	AT+CBST=116,1,0 OK AT+CBST? +CBST:116,1,0 OK
AT+CDIP=n  [M][AT] [&F][&W]	Sets whether to display "Received sub-address" on your personal computer when you receive a call.	n=0: Does not display "Received sub-address" when you receive a call. (default) n=1: Displays "Received sub-address" when you receive a call. Result: +CDIP:<n>,<m> m=0: Not signed up for Multi Number m=1: Signed up for Multi Number m=2: Unknown	AT+CDIP=0 OK AT+CDIP? +CDIP:0,1 OK
AT+CEER  [M]	Displays the reason why the preceding call was disconnected.	<report> Disconnection reason list (See page 53)	AT+CEER +CEER:36 OK
AT+CGDCONT  [M]	Sets the access point name (APN) for when dialing for packet communication.	See page 52.	See page 52.
AT+CGEQMIN  [M]	Registers the reference value to judge whether the system permits QoS (Quality of service) reported from the network at establishment of the packet communication.	AT+CGEQMIN=[parameter] See page 52. AT+CGEQMIN=? Lists the settable values. AT+CGEQMIN? Displays the current setting.	See page 52.
AT+CGEQREQ  [M]	Sets QoS (Quality of service) to be requested to the network at dialing of the packet communication.	AT+CGEQREQ=[parameter] See page 52. AT+CGEQREQ=? Lists the settable values. AT+CGEQREQ? Displays the current setting.	See page 52.
AT+CGMR  [M]	Displays the version of the FOMA phone.	—	AT+CGMR 1234512345123456 OK

AT command	Outline	Parameter/Explanation	Command execution example
AT+CGREG=n  [M] [&F][&W]	Sets whether the network registration state is notified. Displays whether you are inside or outside the service area according to the returned notification.	n=0: Not notified. (default) n=1: Notified at switching between the inside and outside of the service area. (Inquiry) AT+CGREG? +CGREG: <n>,<stat> n: Set value stat: 0: Outside packet area 1: Inside packet area 4: Unknown 5: Inside packet area (during roaming)	AT+CGREG=1 OK (set to "Notified") AT+CGREG? +CGREG:1,0 OK (means the outside of the service area)  (when moved from the outside to the inside of the service area) +CGREG: 1
AT+CGSN  [M]	Displays the serial number of the FOMA phone.	—	AT+CGSN 123456789012345 OK
AT+CLIP=n  [AT][M] [&F][&W]	Enables to display the other party's caller ID on the personal computer at reception of 64K data communication or videophone calls.	n=0: Does not notify. (default) n=1: Notifies.  Result: +CLIP: <n>,<m> m=0: NW setting not to notify caller ID at calling m=1: NW setting to notify caller ID at calling m=2: Unknown	AT+CLIP=0 OK AT+CLIP? +CLIP:0,1 OK
AT+CLIR=n  [M]	Sets whether to notify your phone number to do 64K data communication or to make videophone calls.	n=0: Notifies (does not notify) caller ID according to CLIR service. n=1: Does not notify the other party of your caller ID. n=2: Notifies the other party of your caller ID. (default) Result: +CLIR: <n>,<m> m=0: CLIR is not launched. (always notify) m=1: CLIR is launched. (always not notify) m=2: Unknown m=3: CLIR temporary mode (not notify, default) m=4: CLIR temporary mode (notify, default)	AT+CLIR=0 OK AT+CLIR? +CLIR:0,1 OK AT+CLIR=? +CLIR:(0-2) OK
AT+CMEE=n  [M] [&F][&W]	Sets how the FOMA phone shows an error report.	n=0: Uses the ordinary ERROR result. (default) n=1: +CME ERROR: Uses the <err> result code. <err> indicates a numeric value. n=2: +CME ERROR: Uses the <err> result code. <err> indicates characters. AT+CMEE?: Displays the current setting. Command execution examples on the right are for when the FOMA phone or connection has abnormality. Below listed are the +CME ERROR result codes. 1: no connection to phone 10: SIM not inserted 15: SIM wrong 16: incorrect password 100: unknown	AT+CMEE=0 OK AT+CNUM ERROR AT+CMEE=1 OK AT+CNUM +CME ERROR: 10 AT+CMEE=2 OK AT+CNUM +CME ERROR: SIM not inserted
AT+CNUM  [AT][M]	Displays the own phone number of the FOMA phone.	number: Phone number (In B Mode of 2in1, Number B is displayed.) type: 129 or 145 129: Does not include the IDD prefix code (+). 145: Includes the IDD prefix code (+). Result: +CNUM:,<number>,<type>	AT+CNUM +CNUM:,"+8190123 45678",145 OK



AT command	Outline	Parameter/Explanation	Command execution example
AT+COPS=n,2,m  [M]	Selects the carrier to be connected.	n=0: Automatic (searches the network and switches the network operator automatically) (default) n=1: Manual (connects to the network operator specified in "m") n=2: Disconnects the connection to the network operator n=3: Mapping is not performed. n=4: Manual/Automatic (if the connection to the network operator specified in "m" fails, works as automatic mode.) m: Country code (MCC) and operator code (MNC) are displayed in a hexadecimal number. The format is as follows: Digit 1 of MCC . . . octet 1 bits 1 to 4. Digit 2 of MCC . . . octet 1 bits 5 to 8. Digit 3 of MCC . . . octet 2 bits 1 to 4. Digit 3 of MNC . . . octet 2 bits 5 to 8. Digit 2 of MNC . . . octet 3 bits 5 to 8. Digit 1 of MNC . . . octet 3 bits 1 to 4.	AT+COPS=1,2,"44F001" OK
AT+CPAS  [M]	Displays whether to send the control signals to the FOMA phone.	Result: +CPAS:n n=0: Can send/receive control signals to/from the FOMA phone. n=1: Cannot send/receive control signals to/from the FOMA phone. n=2: Unknown (control signal sending/receiving is not assured). n=3: Can send/receive control signals to/from the FOMA phone, and currently receiving. n=4: Can send/receive control signals to/from the FOMA phone, and currently communicating.	AT+CPAS +CPAS:0 OK
AT+CPIN=n,m  [M][AT]	Enters the UIM password (PIN1 or PIN2).	When the UIM is in a state waiting for the entry of PIN1 or PIN2 code n: PIN1/PIN2 When the UIM is in a state waiting for the entry of PUK due to failure in unblocking PIN1 or PIN2 code n: PUK m: New PIN1 or PIN2 AT+CPIN?: Displays the state of code entry requested about current SIM. Result: +CPIN: <state> <state>=READY: Code entry not requested <state>=SIM PIN: PIN1 code entry waited <state>=SIM PIN2: PIN2 code entry waited <state>=SIM PUK: PUK entry waited due to failure in unblocking PIN1 code <state>=SIM PUK2: PUK entry waited due to failure in unblocking PIN2 code	AT+CPIN="1234" OK AT+CPIN="12345678", "1234" OK AT+CPIN? +CPIN:SIM PIN OK
AT+CR=n  [M] [&F][&W]	Displays the bearer service type before the CONNECT result code appears at connection of the line.	n=0: Does not display. (default) n=1: Displays. <serv>: Displays only "GPRS" that means packet communication. (Displays "SYNC", "AV32K", or "AV64K", depending on the line type.) AT+CR?: Displays the current set value.	AT+CR=1 OK ATD*99**1# +CR: GPRS CONNECT
AT+CRC=n  [AT][M] [&F][&W]	Sets whether the extended result code is used at reception.	n=0: Does not use +CRING. (default) n=1: Uses +CRING.<type>. AT+CRC?: Displays the current setting. The +CRING format is as follows: +CRING: <type> During PPP packet ringing +CRING: GPRS "PPP",,<APN>	AT+CRC=0 OK AT+CRC? +CRC: 0 OK

AT command	Outline	Parameter/Explanation	Command execution example
AT+CREG=n  [AT][M] [&F][&W]	Sets whether the result is displayed about the inside and outside of the service area.	n=0: Not notified. (default) n=1: Notified at switching between the inside and outside of the service area. (Inquiry) AT+CREG? +CREG: <n>,<stat> n: Set value stat: 0: Outside voice call area 1: Inside voice call area 4: Unknown 5: Inside voice call area (during roaming)	AT+CREG=1 OK (set to "Notified") AT+CREG? +CREG: 1,0 OK (means the outside of the service area)  (when moved from the outside to the inside of the service area) +CREG: 1
AT+CUSD=n,"<str">,0  [M] [&F][&W]	Sets or checks the additional service for network.	n=0: Does not display mid result. (default) n=1: Displays mid result. <str>: Service code Mid result: m,"<str">,0 m=0: Shows the setting is completed. m=1: Shows the network requires the information.	AT+CUSD=0, OK AT+CUSD=1,"*148*1*0000#",0 +CUSD:0,"148*7#",0 OK
AT+FCLASS=n  [M] [&F][&W]	Sets communication class in the FOMA phone.	n=0: Data communication (default)	AT+FCLASS=0 OK
AT+GCAP  [M]	Displays the AT command supported by FOMA phone.	Result +GCAP: n n=+CGSM: Some or all GSM commands are supported. n=+FCLASS: +FCLASS command is supported. n=+W: +W command is supported.	AT+GCAP +GCAP:+CGSM,+FCLASS,+W OK
AT+GMI  [M]	Displays the manufacturer name (Panasonic).	—	AT+GMI Panasonic OK
AT+GMM  [M]	Displays the product name (FOMA P706imiyu) of the FOMA phone.	—	AT+GMM FOMA P706imiyu OK
AT+GMR  [M]	Displays the version of the FOMA phone.	—	AT+GMR Ver1.00 OK
AT+IFC=n,m  [M] [&F][&W]	Selects the flow control method.	n: DCE by DTE m: DTE by DCE 0: No flow control 1: XON/XOFF flow control 2: RS/CS (RTS/CTS) flow control Default: n, m = 2.2 AT+IFC?: Inquires the set value.	AT+IFC=2,2 OK
AT+WS46=n  [M] [&F][&W]	Selects the wireless communication network of the FOMA phone.	Returns "ERROR" for the mode setting because the wireless communication network is not selected on the FOMA phone by this command. n=22: W-CDMA (Wideband CDMA)	AT+WS46=22 ERROR AT+WS46? 22 OK
ATA  [M]	Performs the receiving process in the mode when the FOMA phone received the incoming call.	—	RING ATA CONNECT
ATD  [M]	Performs the automatic outgoing process to the FOMA phone according to the contents specified in the parameter and dial parameter.	<cid>: 1 to 10. Displays the APN defined by +CGDCONT. When calling cid1, you can omit the phone number like "ATD*99**.*#."	ATD*99**.*1# CONNECT
ATEn [M] [&F][&W]	Sets whether echo-back is issued to the DTE in the command mode.	n=0: Issues no echo-back. n=1: Issues echo-back. (default)	ATE1 OK
ATHn  [M]	Places the FOMA phone into the on-hook state.	n=0: Disconnects the line. (can be omitted)	(During packet communication) +++ ATH NO CARRIER

AT command	Outline	Parameter/Explanation	Command execution example
ATIn  [AT][M]	Displays the ID code.	n=0: Displays "NTT DoCoMo". n=1: Displays the product name. (same as +GMM) n=2: Displays the version of the FOMA phone. (same as +GMR) n=3: Displays ACMP information element. n=4: Displays the details of the function available for communication on the FOMA phone.	ATI0 NTT DoCoMo OK ATI1 FOMA P706imyu OK
ATOn  [M]	Returns from the online command mode to the online data mode during communication.	n=0: Returns from the online command mode to the online data mode. (can be omitted)	ATO CONNECT
ATQn  [M] [&F]&W]	Sets whether the result code is to be displayed for the DTE.	n=0: Displays the result code. (default) n=1: Does not display the result code.	ATQ0 OK ATQ1 ("OK" is not returned at this time.)
ATS0=n  [M] [&F]&W]	Sets the number of rings required until the FOMA phone automatically receives an incoming call.	n=0: Does not automatically receive an incoming call. (default) n=1 to 255: Automatically receives an incoming call with the specified number of rings. (when $n \geq 10$ , does not automatically receive a packet (PPP) incoming call, then the line is disconnected after about 30 seconds.) ATS0?: Inquires the set value.	ATS0=0 OK ATS0? 000 OK
ATS2=n  [M] [&F]	Sets the escape character.	n=43: Default n=127: Makes escape processing invalid.  ATS2?: Inquires the set value.	ATS2=43 OK ATS2? 043 OK
ATS3=n  [M] [&F]	Sets the carriage return (CR) character.	n=13: Default (n=13 only specifiable)  ATS3?: Inquires the set value.	ATS3=13 OK ATS3? 013 OK
ATS4=n  [M] [&F]	Sets the line feed (LF) character.	n=10: Default (n=10 only specifiable)  ATS4?: Inquires the set value.	ATS4=10 OK ATS4? 010 OK
ATS5=n  [M] [&F]	Sets the back space (BS) character.	n=8: Default (n=8 only specifiable)  ATS5?: Inquires the set value.	ATS5=8 OK ATS5? 008 OK
ATS30=n  [M][&F]	Sets the inactive timer (minute). When no user data is sent or received, the connection is cut after the set time has elapsed. This command is for only 64K data communication. When 0 is set, the inactive timer turns to OFF.	n=0 to 255 (default=0) (unit: minute)	ATS30=0 OK
ATS103=n  [M][&F]	Selects characters to pause for incoming sub-address.	n=0: *(asterisk) n=1: / (slash) (default) n=2: ¥ or back slash	ATS103=0 OK
ATS104=n  [M][&F]	Selects characters to pause for outgoing sub-address.	n=0: # (sharp) n=1: % (percentage) (default) n=2: & (and)	ATS104=0 OK
ATVn [M] [&F]&W]	Sets all the result codes in the numeric or alphabetical notation.	n=0: Returns the result code in a numeric value. n=1: Returns the result code in alphabetical characters. (default)	ATV1 OK
ATXn  [M] [&F]&W]	Sets whether to display the speed in the CONNECT display at connection. Detects busy tone and dial tone.	n=0: Dial tone not detected; busy tone not detected; speed not displayed. n=1: Dial tone not detected; busy tone not detected; speed displayed. n=2: Dial tone detected; busy tone not detected; speed displayed. n=3: Dial tone not detected; busy tone detected; speed displayed. n=4: Dial tone detected; busy tone detected; speed displayed. (default)	ATX1 OK

AT command	Outline	Parameter/Explanation	Command execution example
ATZ [M]	Resets the setting to the contents of the nonvolatile memory. If this command is entered during communication, the line is disconnected.	—	(In online) ATZ NO CARRIER (In offline) ATZ OK
AT+VS [M]	Displays the contents of the each command and S register currently set.	—	AT+VS E1 Q0 V1 X4 &C1 &D2 &S0 &E1 %V0 S000=000 S002=043 S003=013 S004=010 S005=008 S006=005 S007=060 S008=003 S010=001 S030=000 S103=000 S104=000 OK
AT+Vn [M] [&F][&W]	Selects the response code specifications at connection.	n=0: Does not use the extended result code. (default) n=1: Uses the extended result code.	AT+V0 OK

※ The following commands do not result in an error even if specified; however, they do not function as commands.

- AT (AT only entered.)
- ATT (Tone setting)
- ATP (Pulse setting)
- ATS6 (Setting the pause time taken for dialing)
- ATS8 (Setting the pause time by comma dialing)
- ATS10 (Setting the automatic disconnection delay time)

## Supplementary Explanation of AT Commands

### ● Command name: +CGDCONT [M]

- Outline
 

This command sets an access point name (APN) for when dialing for packet communication.
- Format
 

```
+CGDCONT=[<cid>[,<PDP_type>[,<APN>]]]
```
- Explanation of parameters
 

You set an access point name (APN) for when dialing for packet communication. See the example below for command instructions.

```
<cid>※: 1 to 10
<PDP_type>: PPP or IP
<APN>※: Arbitrary
※<cid> is a number used to manage an access point name (APN) for packet communication, which is registered in the FOMA phone.
You can register 1 to 10 in the FOMA phone. "mopera.ne.jp" is registered to <cid>=1, and "mopera.net" is registered to <cid>=3, each at purchase, so register 2 or 4 through 10.
<APN> indicates any character string for each access point name.
```
- Operation at omission of parameters
 

```
+CGDCONT= : Sets all the <cid> contents to the default.
+CGDCONT=<cid> : Sets the specified <cid> to the default.
+CGDCONT=? : Lists the specifiable values.
+CGDCONT? : Displays the current setting.
```
- Command execution example
 

```
AT+CGDCONT=2,"PPP","abc"
OK
※The command used to register an APN name, abc (cid=2)
※This command, which is a setting command, is not stored in the nonvolatile memory written by [&W], and is not reset by [&F] and [Z], either.
```

### ● Command name: +CGEQMIN=[parameter] [M]

- Outline
 

This command registers the reference value to judge whether the system permits QoS (Quality of service) reported from the network at establishment of the packet communication.

You can specify four setting patterns described in the command execution example below.
- Format
 

```
+CGEQMIN=[<cid>[,<Maximum bitrate UL>[,<Maximum bitrate DL>]]]
```
- Explanation of parameters
 

```
<cid>※ : 1 to 10
<Maximum bitrate UL>※ : None (default) or 384
<Maximum bitrate DL>※ : None (default) or 3648
※<cid> is a number used to manage an access point name (APN) for packet communication, which is registered in the FOMA phone.
You can register 1 to 10 in the FOMA phone. "mopera.ne.jp" is registered to <cid>=1 and "mopera.net" is registered to <cid>=3, each at purchase, so register 2 or 4 through 10.
<Maximum bitrate UL> and <Maximum bitrate DL> are used to specify the minimum baud rates (kbps) for upload and download between the FOMA phone and base station. "None" (default) accepts all baud rates; however, 384 and 3648 do not accept a baud rate other than 384 kbps and 3648 kbps. If you specify 384 and 3648, you may not establish packet communication.
```
- Operation at omission of parameters
 

```
+CGEQMIN= : Sets all the <cid> contents to the default.
+CGEQMIN=<cid> : Sets the specified <cid> to the default.
```

### · Command execution example

You can specify only the following four setting patterns: (The setting in (1) is defined in each cid as the default.)

- (1) Command that accepts all the baud rates for both upload and download (cid=2)
 

```
AT+CGEQMIN=2
OK
```
- (2) Command that accepts 384 kbps for upload and 3648 kbps for download (cid=3)
 

```
AT+CGEQMIN=3,384,3648
OK
```
- (3) Command that accepts 384 kbps for upload and all baud rates for download (cid=4)
 

```
AT+CGEQMIN=4,,384
OK
```
- (4) Command that accepts all baud rates for upload and 3648 kbps for download (cid=5)
 

```
AT+CGEQMIN=5,,3648
OK
```

※ This command, which is a setting command, is not stored in the nonvolatile memory written by [&W], and is not reset by [&F] and [Z], either.

### ● Command name: +CGEQREQ=[parameter] [M]

- Outline
 

This command sets QoS (Quality of service) to be requested to the network at dialing of the packet communication.

You can specify only one setting pattern described in the command execution example below, which is set as the default.
- Format
 

```
+CGEQREQ=[<cid>]
```
- Explanation of parameter
 

```
<cid>※: 1 to 10
※<cid> is a number used to manage an access point name (APN) for packet communication, which is registered in the FOMA phone.
You can register 1 to 10 in the FOMA phone. "mopera.ne.jp" is registered to <cid>=1 and "mopera.net" is registered to <cid>=3, each at purchase, so register 2 or 4 through 10.
```
- Operation at omission of parameter
 

```
+CGEQREQ= : Sets all the <cid> contents to the default.
+CGEQREQ=<cid> : Sets the specified <cid> to the default.
```
- Command execution example
 

You can specify only the following one pattern: (This setting is defined in each cid as the default.)

  - (1) Command that requests a connection at 384 kbps for upload and 3648 kbps for download (cid=3)
 

```
AT+CGEQREQ=3
OK
```

※ This command, which is a setting command, is not stored in the nonvolatile memory written by [&W], and is not reset by [&F] and [Z], either.

### ● Command name: +CLIP

- Outline
 

The result for "AT+CLIP=1" is displayed in the following format:

```
+CLIP: <number> <type>
```
- Command execution example
 

```
AT+CLIP=1
OK
RING
+CLIP: "09012345678",49
```

## Disconnection Reason List

### ■64K Data Communication

Value	Reason
1	The specified number does not exist.
16	The line was normally disconnected.
17	Cannot communicate because the other party is communicating.
18	Dialed but no response has come in within the specified duration.
19	Cannot communicate because the other party is dialing.
21	The other party rejected to receive the call.
63	The network service and options are not valid.
65	The specified transmission performance is not provided.
88	Dialed to or received the call from the phone with different properties.

### ■Packet Communication

Value	Reason
27	No APN was found; or an invalid APN was specified.
30	The line was disconnected from the network.
33	You have not applied for the service option you requested.
36	The line was normally disconnected.

## Result Codes

### ■Result Code List

Numeric notation	Character notation	Meaning
0	OK	Processing has been executed normally.
1	CONNECT	The line has been connected to the other party.
2	RING	An incoming call has arrived.
3	NO CARRIER	The line has been disconnected.
4	ERROR	The system can receive no command.
6	NO DIALTONE	The system can detect no dial tone.
7	BUSY	The system is detecting the busy tone.
8	NO ANSWER	The connection completed; timeout
100	RESTRICTION	The network is restricted.
101	DELAYED	Within restricted redialing time

### ■Extended Result Code List

For &E0

Connection speed between the FOMA phone and the base station is displayed.

Numeric notation	Character notation	Connection speed
121	CONNECT 32000	32,000bps
122	CONNECT 64000	64,000bps
125	CONNECT 384000	384,000bps
133	CONNECT 3648000	3,648,000bps

For &E1

Numeric notation	Character notation	Connection speed
5	CONNECT 1200	1,200bps
10	CONNECT 2400	2,400bps
11	CONNECT 4800	4,800bps
13	CONNECT 7200	7,200bps
12	CONNECT 9600	9,600bps
15	CONNECT 14400	14,400bps
16	CONNECT 19200	19,200bps
17	CONNECT 38400	38,400bps
18	CONNECT 57600	57,600bps
19	CONNECT 115200	115,200bps
20	CONNECT 230400	230,400bps
21	CONNECT 460800	460,800bps

## Information

- Result codes are displayed in the character notation (default) when the ATVn command (see page 50) is set to n=1 and displayed in the numeric notation when it is set to n=0.
- The baud rate is displayed to keep the compatibility with a conventional modem connected via RS-232C. However, the FOMA phone and personal computer are connected via the FOMA USB Cable with Charge Function 01/02 (option); so, the baud rate is different from the actual connection speed.
- "RESTRICTION" (numeric notation: 100) means that the communication network is congested. If this result code appears, wait for a while, then connect the line again.

### ■Communication Protocol Result Code List

Numeric notation	Character notation	Meaning
1	PPPOverUD	Connected by 64K data communication
2	AV32K	Connected by 32K videophone
3	AV64K	Connected by 64K videophone
5	PACKET	Connected by packet communication

### ■Result Code Display Examples

- When ATX0 is set:

CONNECT only appears at completion of the connection, regardless of the contents specified in the ATV command (see page 51).

Example in character notation: ATD\*99\*\*\*1#  
CONNECT

Example in numeric notation: ATD\*99\*\*\*1#  
1

- When ATX1 is set\*:

- If ATX1 and ATV0 are set (default):

A result code appears in the following format at completion of the connection: CONNECT<baud rate between the FOMA phone and PC>

Example in character notation: ATD\*99\*\*\*1#  
CONNECT 460800

Example in numeric notation: ATD\*99\*\*\*1#  
1 21

- If ATX1 and ATV1 are set\*:

A result code appears in the following format at completion of the connection: CONNECT<baud rate between the FOMA phone and PC>-PACKET<access point name (APN)>-<maximum baud rate for upload (the FOMA phone → wireless base station)>-<maximum baud rate for download (the FOMA phone ← wireless base station)>

Example in character notation: ATD\*99\*\*\*1#  
CONNECT 460800 PACKET  
mopera.ne.jp /384/3648  
(Indicates that the FOMA phone connected to mopera.ne.jp at maximum 384 kbps for upload and maximum 3648 kbps for download.)

Example in numeric notation: ATD\*99\*\*\*1#  
1215

- \*If you specify ATX1 and ATV1 at the same time, you may not be able to correctly carry out the dial-up connection. You are advised to use only ATV0.

**FOMA® P706iμ**

# **Kuten Code List**









