

**SAMSUNG**

# GSM TELEPHONE

## SGH-C130

# ***SERVICE*** *Manual*

### GSM TELEPHONE



### CONTENTS

1. Safety Precautions
2. Specification
3. Product Function
4. Array course control
5. Exploded View and Parts List
6. Disassembly and Assembly instructions
7. MAIN Electrical Parts List
8. Block Diagrams
9. PCB Diagrams
10. Flow Chart of Troubleshooting
11. Reference data

# Contents

## 1. Safety Precautions

- 1-1. Repair Precaution .....1-1
- 1-2. ESD(Electrostatically Sensitive Devices) Precaution .....1-2

## 2. Specification

- 2-1. GSM General Specification .....2-1
- 2-2. GSM Tx Power Class .....2-2

## 3. Product Function

- 3-1. Main Function .....3-1

## 4. Array course control

Software Downloading

- 4-1. Downloading Binary Files .....4-2
- 4-2. Pre-requisite for Downloading .....4-2
- 4-3. S/W Downloader Program .....4-3

## 5. Exploded View and Parts List

- 5-1. Cellular phone Exploded View .....5-1
- 5-2. Cellular phone Part list .....5-2

## 6. Disassembly and Assembly instructions

- 6-1. Disassembly .....6-1
- 6-2. Assembly .....6-3

## 7. MAIN Electrical Parts List

## 8. Block Diagrams

## 9. PCB Diagrams

## 10. Flow Chart of Troubleshooting

- 10-1. Baseband
    - 10-1-1. Power ON .....10-1
-

# Contents

10-1-2. Initial .....	10-5
10-1-3. Sim Part .....	10-8
10-1-4. Microphone Part .....	10-10
10-1-5. Receiver Part .....	10-12
10-1-6. Speaker Part .....	10-12
10-2. RF	
10-2-1. EGSM RX .....	10-16
10-2-2. DCS RX .....	10-18
10-2-3. EGSM TX .....	10-20
10-2-4. DCS TX .....	10-22

## 11. Reference data

---

---

# 1. Safety Precautions

---

## 1-1. Repair Precaution

- Repair in Shield Box, during detailed tuning.  
Take specially care of tuning or test,  
because specipicty of cellular phone is sensitive for surrounding interference(RF noise).
- Be careful to use a kind of magnetic object or tool,  
because performance of parts is damaged by the influence of manetic force.
- Surely use a standard screwdriver when you disassemble this product,  
otherwise screw will be worn away.
- Use a thicken twisted wire when you measure level.  
A thicken twisted wire has low resistance, therefore error of measurement is few.
- Repair after separate Test Pack and Set because for short danger (for example an  
overcurrent and furious flames of parts etc) when you repair board in condition of  
connecting Test Pack and tuning on.
- Take specially care of soldering, because Land of PCB is small and weak in heat.
- Surely tune on/off while using AC power plug, because a repair of battery charger is  
dangerous when tuning ON/OFF PBA and Connector after disassembling charger.
- Don't use as you pleases after change other material than replacement registered on SEC  
System. Otherwise engineer in charge isn't charged with problem that you don't keep this  
rules.

## 1-2. ESD(Electrostatically Sensitive Devices) Precaution

Several semiconductor may be damaged easily by static electricity. Such parts are called by ESD(Electrostatically Sensitive Devices), for example IC,BGA chip etc. Read Precaution below. You can prevent from ESD damage by static electricity.

- Remove static electricity remained your body before you touch semiconductor or parts with semiconductor. There are ways that you touch an earthed place or wear static electricity prevention string on wrist.
- Use earthed soldering steel when you connect or disconnect ESD.
- Use soldering removing tool to break static electricity. , otherwise ESD will be damaged by static electricity.
- Don't unpack until you set up ESD on product. Because most of ESD are packed by box and aluminum plate to have conductive power,they are prevented from static electricity.
- You must maintain electric contact between ESD and place due to be set up until ESD is connected completely to the proper place or a circuit board.

---

## 2. Specification

---

### 2-1. GSM General Specification

	<b>GSM900 Phase 1</b>	<b>EGSM 900 Phase 2</b>	<b>DCS1800 Phase 1</b>
Freq. Band[MHz] Uplink/Downlink	890~915 935~960	880~915 925~960	1710~1785 1805~1880
ARFCN range	1~124	0~124 & 975~1023	512~885
Tx/Rx spacing	45 MHz	45 MHz	95 MHz
Mod. Bit rate/ Bit Period	270.833 kbps 3.692 us	270.833 kbps 3.692 us	270.833 kbps 3.692 us
Time Slot Period/Frame Period	576.9 us 4.615 ms	576.9 us 4.615 ms	576.9 us 4.615 ms
Modulation	0.3 GMSK	0.3 GMSK	0.3 GMSK
MS Power	33 dBm~13 dBm	33 dBm~5 dBm	30 dBm~0 dBm
Power Class	5 pcl ~ 15 pcl	5 pcl ~ 19 pcl	0 pcl ~ 15 pcl
Sensitivity	-102 dBm	-102 dBm	-100 dBm
TDMA Mux	8	8	8
Cell Radius	35 Km	35 Km	2 Km

**2-2. GSM TX power class**

<b>TX Power control level</b>	<b>GSM900</b>	<b>TX Power control level</b>	<b>DCS1800</b>
5	33±2 dBm	0	30±3 dBm
6	31±2 dBm	1	28±3 dBm
7	29±2 dBm	2	26±3 dBm
8	27±2 dBm	3	24±3 dBm
9	25±2 dBm	4	22±3 dBm
10	23±2 dBm	5	20±3 dBm
11	21±2 dBm	6	18±3 dBm
12	19±2 dBm	7	16±3 dBm
13	17±2 dBm	8	14±3 dBm
14	15±2 dBm	9	12±4 dBm
15	13±2 dBm	10	10±4 dBm
16	11±3 dBm	11	8±4 dBm
17	9± 3dBm	12	6±4 dBm
18	7±3 dBm	13	4±4 dBm
19	5±3 dBm	14	2±5 dBm
		15	0±5 dBm

---

## **3. Product Function**

---

### **3-1. Main Function**

- Camera and camcorder
- Music player
- Bluetooth
- Web browser
- Get personal with photo caller ID
- Name card
- Multimedia Message Service (MMS)
- Java
- Calendar
- Voice recorder
- Alarm



---

## 4. Array course control

---

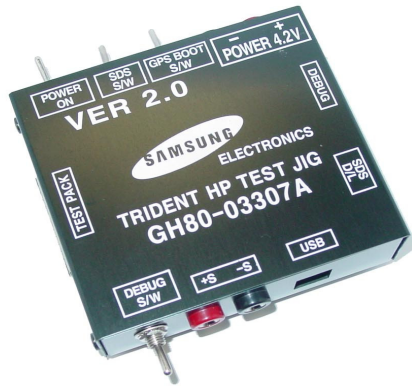

**Test Jig (GH80-03307A)**

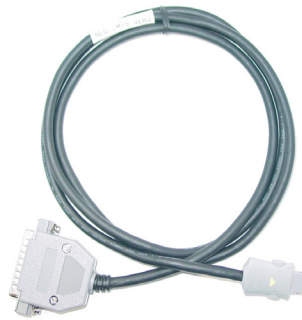

**Test Cable (GH39-00127A)**



**RF Test Cable (GH39-00283A)**

## **Software Downloading**

### **4-1. Downloading Binary Files**

- Three binary files for downloading C130.
  - C130XXYY.s3 : Main source code binary.

### **4-2. Pre-requisite for Downloading**

- Downloader Program([OptiFlash.exe](#))
- C130 Mobile Phone
- Data Cable
- Binary files

### 4-3. S/W Downloader Program

1. Load the binary download program by executing the "OptiFlash.exe"

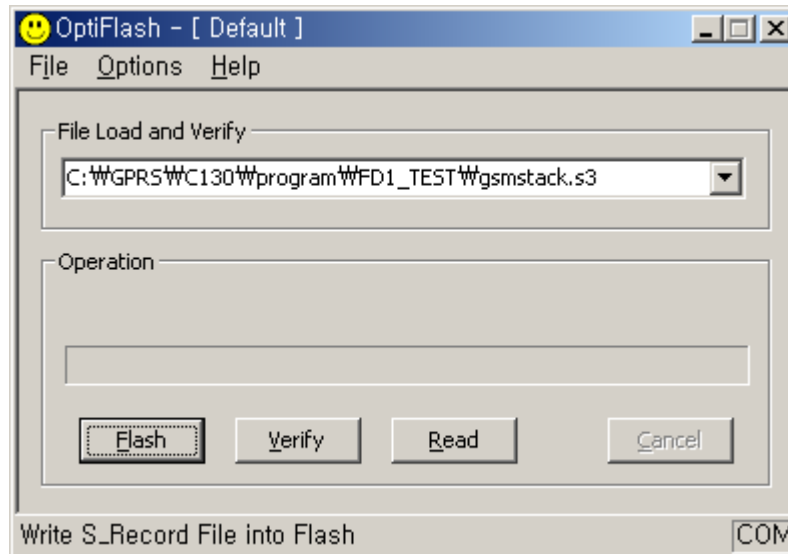

2. Select the "Options" -> "Settings" -> "Generic" -> "Specify hardware platform".

Choose hardware platform for the downloader file setting.

Set the everything else as the default values which are shown below

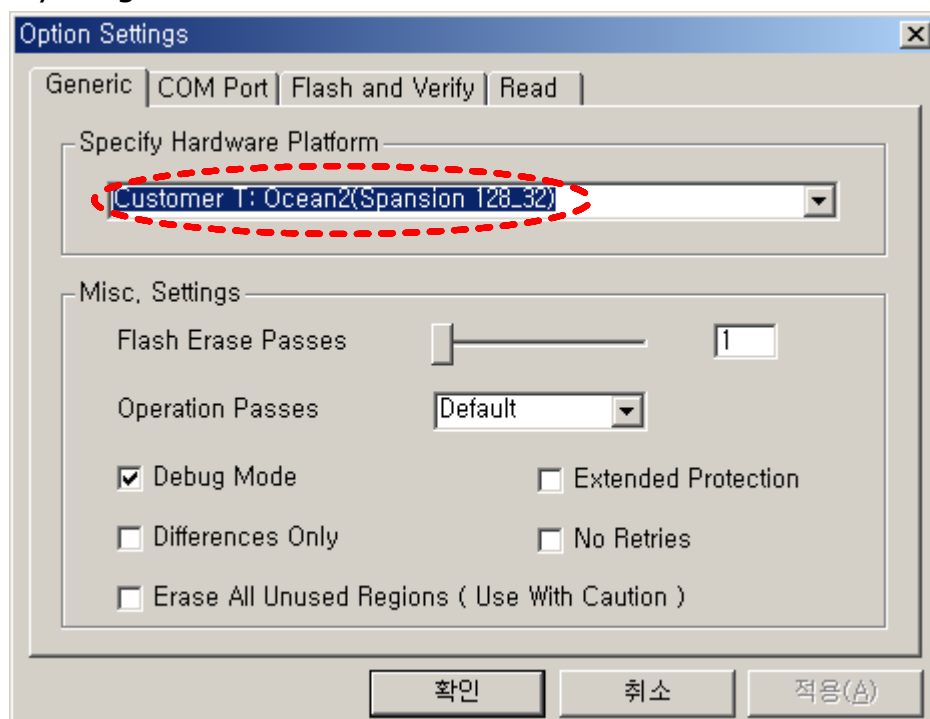

3. Select the **COM port** when the download cable is connected

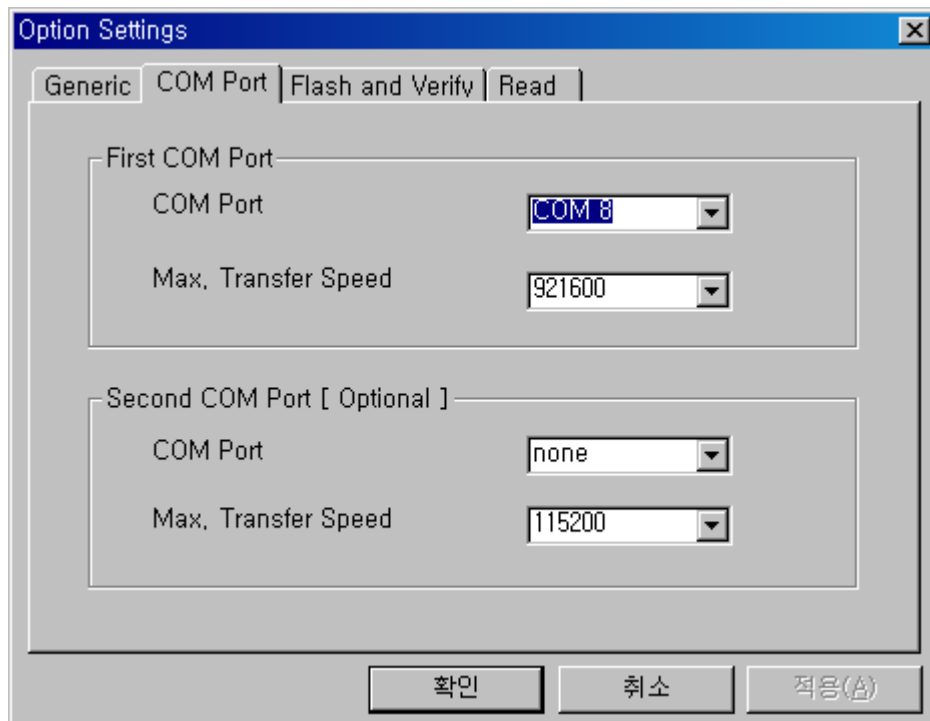

Up to twelve ports are supported. Additionally you can select the maximum transfer speed OptiFlash will use to communicate with the phone. However, OptiFlash will use a slower speed if either the PC's or the phone's serial hardware is incapable of handling the selected speed

4. Select the "**Flash&Verify**" -> "**Browse**"

Set the directory path and choose the latest s/w binary, for example "XC30XXYY.s3", for the downloader binary setting.

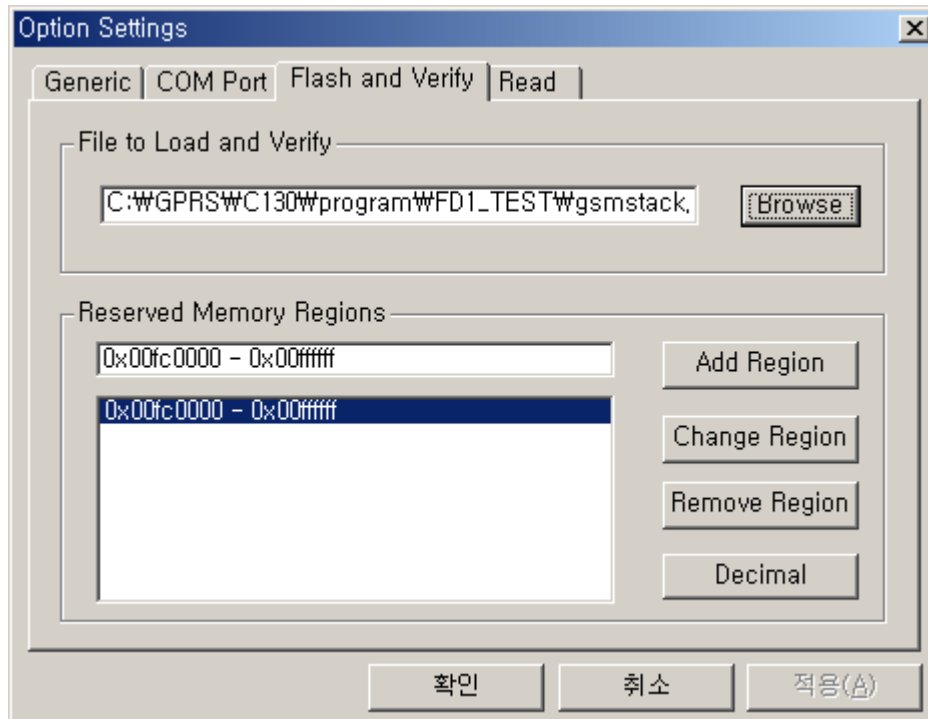

**Make sure that not to change the reserved memory regions.**

**In case of C130 the reserved regions are :**

**-0x00fc0000 - 0x00ffff**

5. Click "OK" button then press "Flash".  
(Before pressing 'Flash' button, push the button '\*' and 'END' at the same time. Then press 'Flash'.)

Downloader will upload the binary file as below for the downloading. 🎵

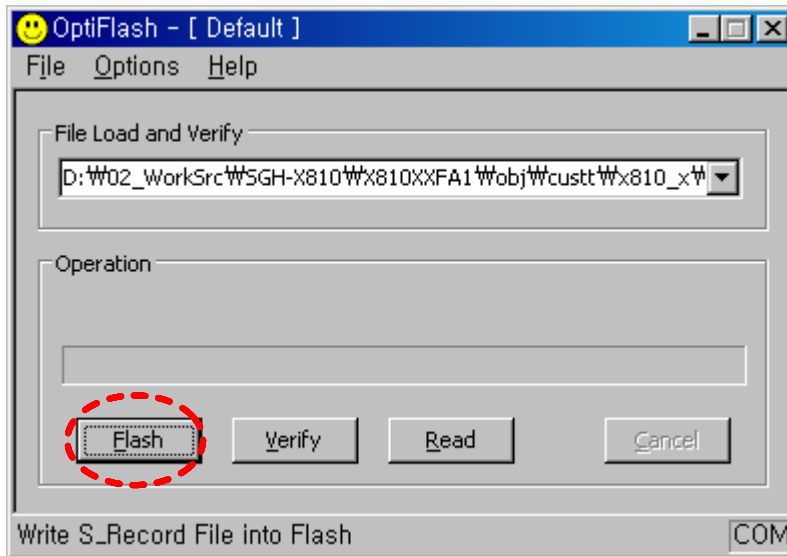

6. When downloading is finished successfully, there is a "All is well" message. 🎵
7. After finishing downloading, Certain memory resets should be done to guarantee the normal performance. 🎵
8. Confirm the downloaded version name and etc. : 🎵

**\*#5002\*8376263#** 🎵

Full Reset : 🎵

**\*2767\*3855#**

---

## 5. Exploded View and Parts List

---

### 5-1. Cellular phone Exploded View

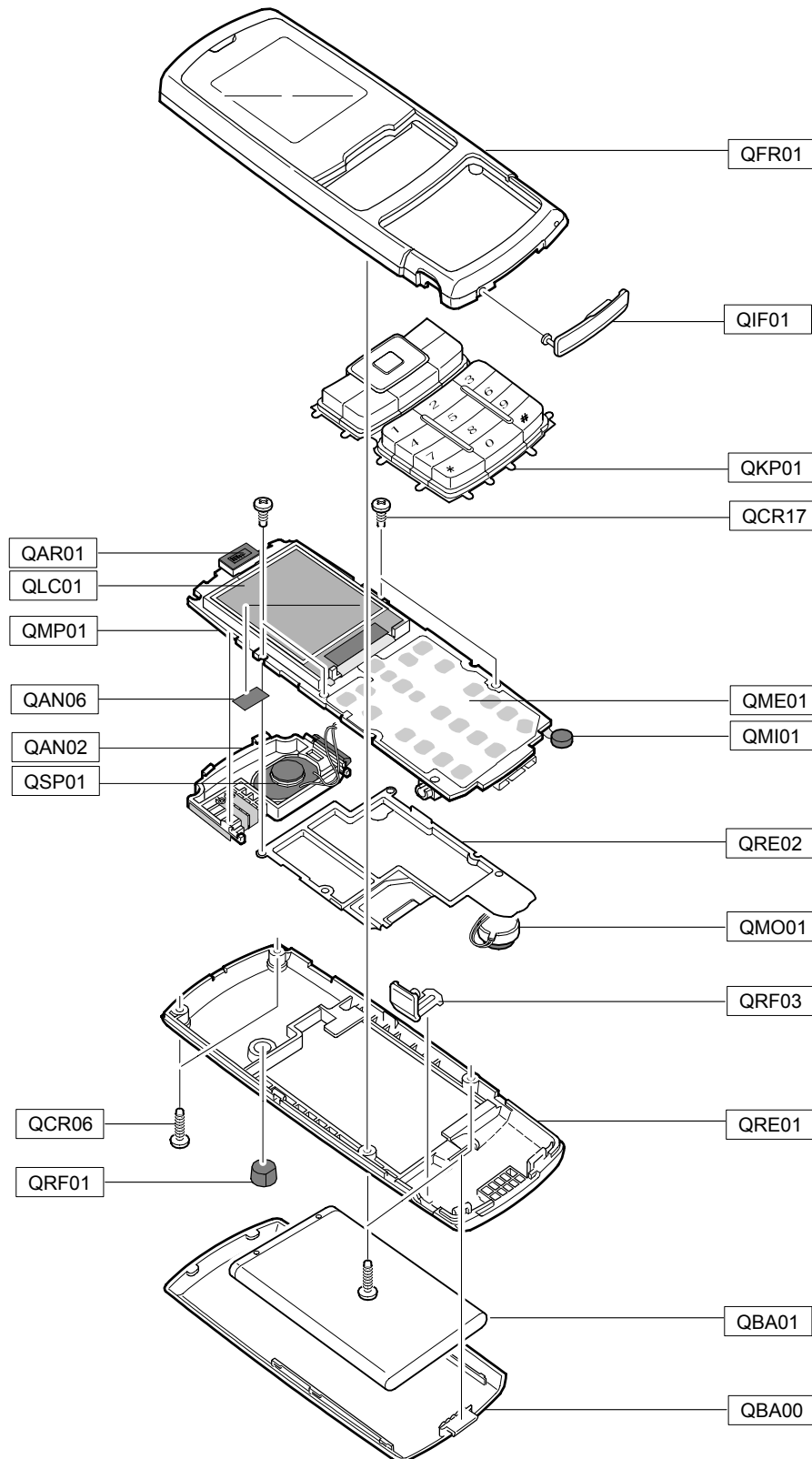

## 5-2. Cellular phone Parts list

Design LOC	Discription	SEC CODE
QAN02	INTENNA-SGHC130	GH42-00826A
QAN06	MEC-ANT CONTACT RUBBER	GH75-09635A
QAR01	AUDIO-RECEIVER	3009-001201
QBA00	MEC-COVER BATT	GH75-09643A
QBA01	INNER BATTERY PACK-750MAH,BLK,	GH43-02483A
QCR06	SCREW-MACHINE	6001-001155
QCR17	SCREW-MACHINE	6001-001460
QKP01	MEC-KEYPAD	GH75-09645A
QLC01	LCD-SGHC130 MODULE	GH07-00915A
QME01	UNIT-METAL DOME	GH59-03151A
QMI01	MICROPHONE-ASSY-SGHC130	GH30-00276A
QMO01	MOTOR-DC	3101-001324
QMP01	PBA MAIN-SGHC130	GH92-02745A
QRE01	MEC-COVER REAR	GH75-09642A
QRE02	MEC-BRACKET REAR	GH75-09644A
QRF01	RMO-COVER RF	GH73-06809A
QRF03	PMO-COVER EAR	GH72-30146A
QSP01	SPEAKER	3001-001966
QFR01	MEC-COVER FRONT	GH75-09641A
QIF01	PMO-COVER IF	GH72-30148A







---

Discription	SEC CODE
BAG PE	6902-000297
ADAPTOR-SGHN288 TAD	GH44-00184A
LABEL(P)-IMEI	GH68-01335D
LABEL(P)-WATER SOAK	GH68-02026A
MANUAL USERS-EU RUSSIAN	GH68-10872A
LABEL(R)-MAIN SEK	GH68-11303B
CUSHION-CASE TA2 MA2	GH69-03897A
BOX(P)-UNIT MAIN(EU)	GH69-04012A
RMO-CUSHION RUBBER TR	GH73-07077A
MPR-SPONGE VIBRATOR	GH74-14818A
MPR-CUSHION INTENNA	GH74-22230A
MPR-CUSHION RCV	GH74-23341A
MPR-TAPE GND	GH74-23342A
MPR-TAPE IF CON	GH74-23343A
MPR-TAPE BACKUP BATTERY	GH74-23544A
MPR-VINYL BOHO MAIN	GH74-24760A

## 6. Disassembly and Assembly instructions

### 6-1. Disassembly

<p>1</p> 	<p>2</p> 
<p>1) Unlock 4 screws.  <b>* caution</b>          1) Be careful not to make scratch and molding damage!</p>	<p>1) Raise up the upper part of SET.  <b>* caution</b>          1) Be careful not to make scratch and molding damage!          2) Must unlock the upper side first.          -If you unlock the lower part first, locker of the lower part is damaged.</p>
<p>3</p> 	<p>4</p> 
<p>1) Unlock rightside of SET  <b>* caution</b>          1) Be careful not to make scratch and molding damage!</p>	<p>1) Unlock leftside of SET  <b>* caution</b>          1) Be careful not to make scratch and molding damage!</p>

5

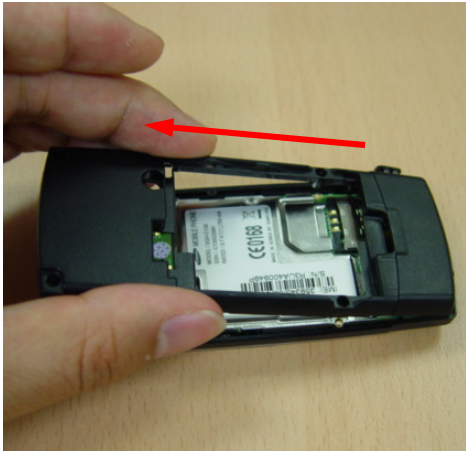

- 1) Holding and pulling the upper part of REAR disassemble the lower part of REAR.

**\* caution**

- 1) Be careful not to make scratch and molding damage!
- 2) Be careful not to make damage of the lower locker!

6



- 1) Holding FRONT and pushing KEA PAD, disassemble the MIC FPCB.
- 2) Pushing KEY PAD under the earjack, disassemble the lower part of PBA

**\* caution**

- 1) Be careful not to make scratch and molding damage!
- 2) When you disassemble PBA, be careful not to make MIC FPCB damage!

7





- 1) Rising up PBA LCD PART slowly and disassemble RECEIVER.

**\* caution**

- 1) Be careful not to make scratch and molding damage!
- 2) Be careful not to make RECEIVER WIRE damage!
- 3) Be careful not to make LCD damage!

8

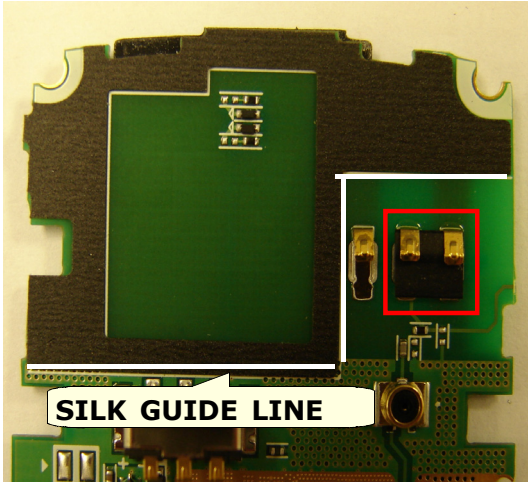
## 6-2. Assembly

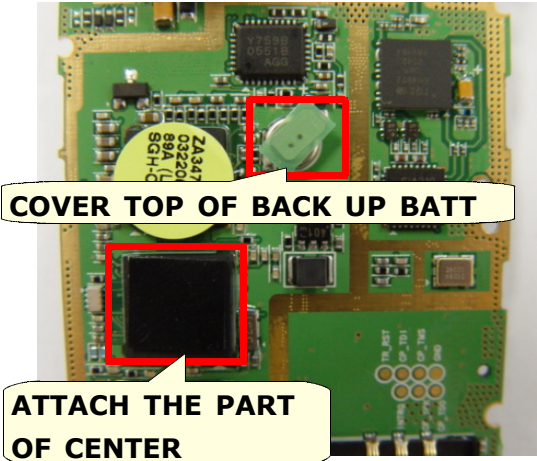
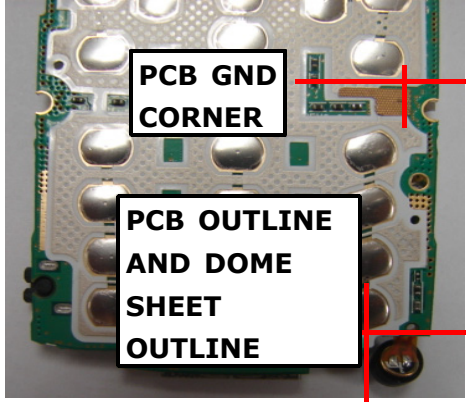
<p>1</p>  <p><b>SILK GUIDE LINE</b></p>	<p>2</p>  <p><b>SILK GUIDE LINE</b></p>
<p>1)fix into silk guide line,Attach the CUSION INTENNA PORON 2)fix into undet intenna contact shape,attach ROBBER.</p>	<p>1) Fix into SILK GUIDE LINE, attach the RECEIVER PORON.</p>
<p>3</p>  <p><b>COVER TOP OF BACK UP BATT</b></p> <p><b>ATTACH THE PART OF CENTER</b></p>	<p>4</p>  <p><b>PCB GND CORNER</b></p> <p><b>PCB OUTLINE AND DOME SHEET OUTLINE</b></p>
<p>1)Attach the CUSION ROBBER on ceter of AGERE TC CHIP. 2)Attach the ELECTRIC TAPE for covering top of BACK UP BATT.</p>	<p>1) Fix into PCB GND corner, Attach the SHIELD GASKET. 2) Fix into outline of DOME SHEET and PCB GRD corner, Attach the ELECTRIC TAPE and cover the reverse side of PCB</p> <p><b>* caution</b></p> <p>1) After attaching the ELECTRIC TAPE, rup up it not to take off.</p>

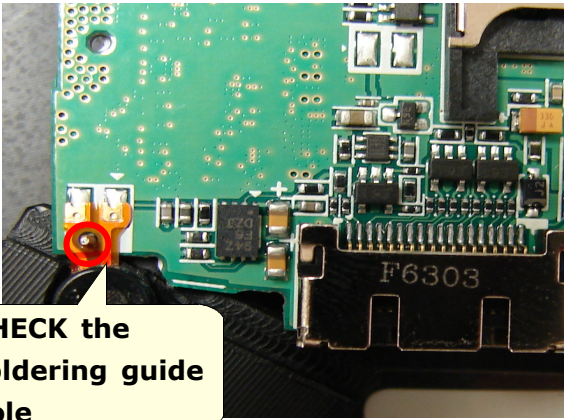
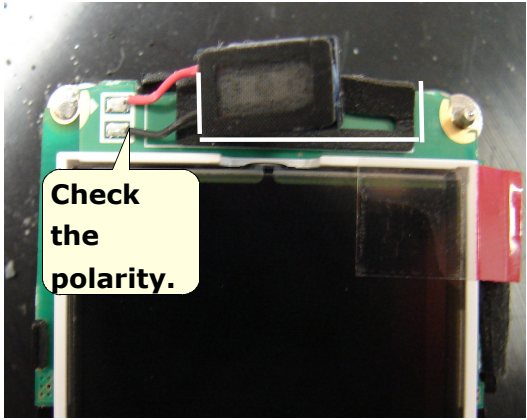
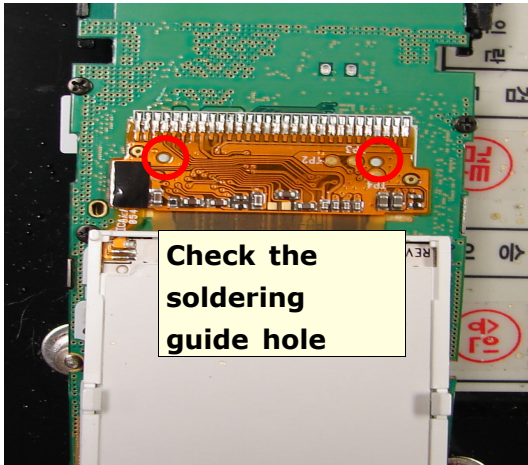
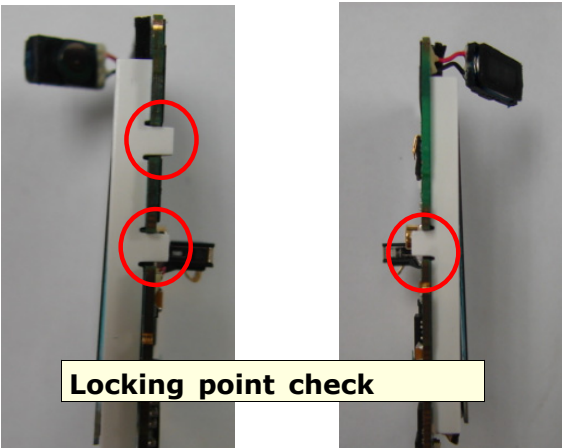
<p>5</p>  <p><b>CHECK the soldering guide hole</b></p>	<p>6</p>  <p><b>Check the polarity.</b></p>
<p>1) Fix into MIC soldering guide hole, solder MIC FPCB.  <b>* caution</b>                  1) Be careful circuit short and soldering error.</p>	<p>1) Check the polarity and and solder the RECEIVER  <b>* caution</b>                  1) Be careful circuit short and soldering error.</p>
<p>7</p>  <p><b>Check the soldering guide hole</b></p>	<p>8</p>  <p><b>Locking point check</b></p>
<p>1) Fix into LCD FPCB soldering guide hole, solder LCD FPCB.  <b>* caution</b>                  1) Be careful not to make LCD FPCB damage.                  2) Be careful circuit short and soldering error.</p>	<p>1) Assemble the LCD ON the PCB.  <b>* caution</b>                  1) Be careful not to make LCD FPCB damage.</p>

9

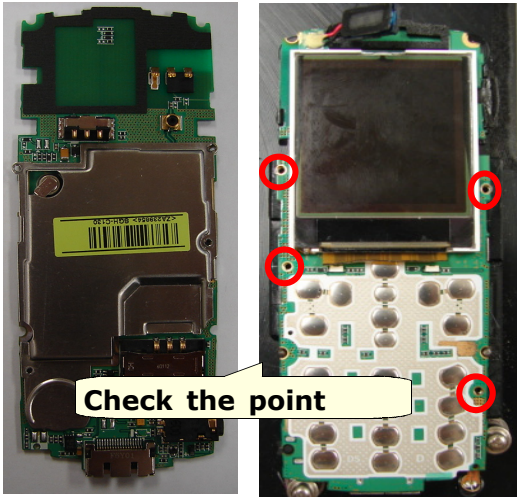

Check the point

- 1) Screw up the SHEILD CAN at 4 Points.  
[M1.4 x L2.3]

**\* caution**

- 1) Torque  $0.8 \pm 0.1$  Kgf/cm<sup>2</sup>
- 2) Be careful not to damage LCD !

10

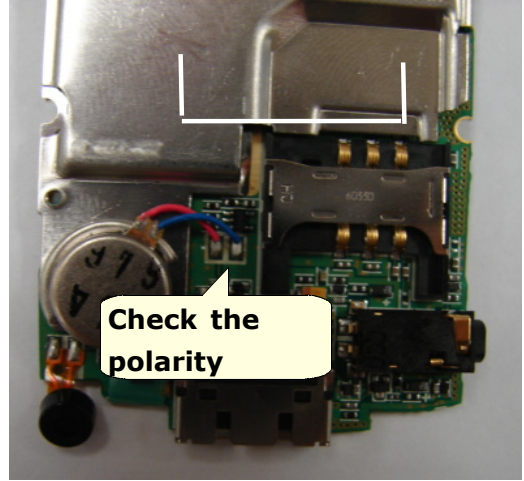

Check the polarity

- 1) Check the polarity and and solder the RECEIVER
- 2) Attach the MOTER on the SHIELD CAN  
**\* caution**
  - 1) Attaching moter, check the direction.  
(same as picture)
  - 2) Be careful circuit short and soldering error.

11

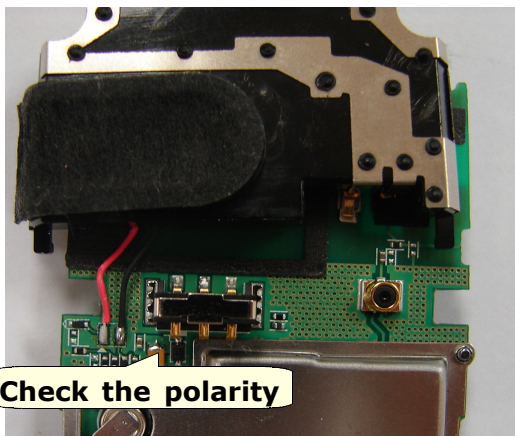

Check the polarity

- 1)Check the polarity of SPEAKER, solder it  
**\* caution**
- 1) Be careful circuit short and soldering error.

12

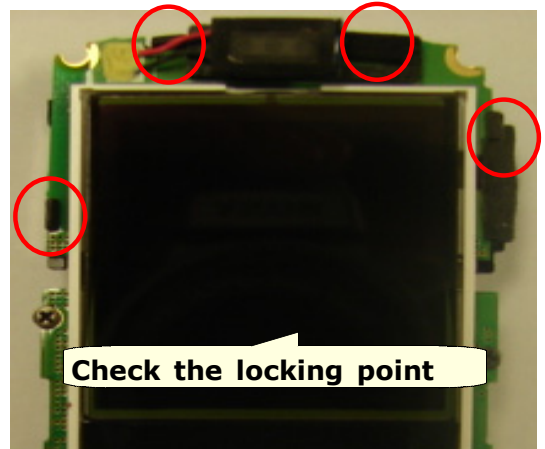

Check the locking point

- 1)Assemble intenna on PBA  
**\* caution**
- 1) Be careful not to damage LCD !

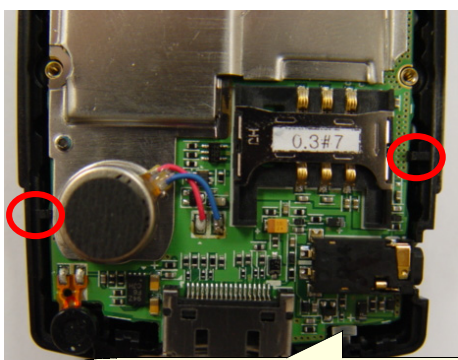
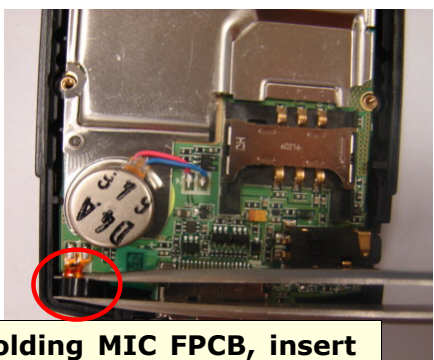
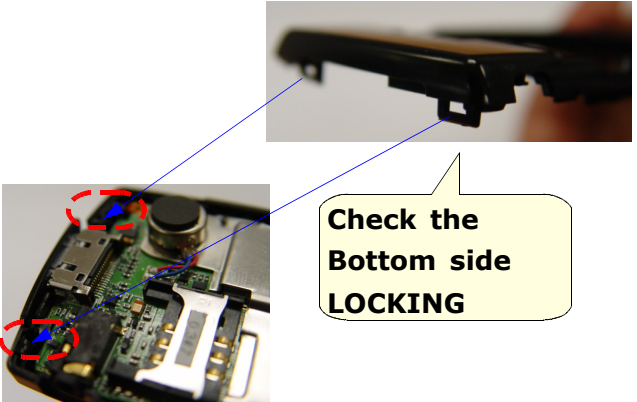
<p><b>13</b></p>  <p><b>After inserting reciver, insert LCD</b></p>	<p><b>14</b></p>  <p><b>After inserting PBA, check the locking point</b></p>
<p>1) Insert RECEIVER in the FRONT  <b>* caution</b>                  1) Torque <math>0.8 \pm 0.1 \text{ Kgf/cm}^2</math>                  2) Be careful not to make scratch and molding damage!</p>	<p>1) Insert PBA in the FRONT.  <b>* caution</b>                  1) Inserting PBA, be careful not to make MIC FPCB damage!                  2) Be careful not to make scratch and molding damage!</p>
<p><b>15</b></p>  <p><b>Folding MIC FPCB, insert it in FRONT</b></p>	<p><b>16</b></p>  <p><b>Check the Bottom side LOCKING</b></p>
<p>1) Insert MIC in the FRONT MIC HOLE.  <b>* caution</b>                  1) Be careful not to make the MIC FPCB damage!                  2) Be careful not to make scratch and molding damage!</p>	<p>1) Assemble FRONT and ROAR Locker..  <b>* caution</b>                  1) Be careful not to make locker damage                  2) Be careful not to make scratch and molding damage!</p>

17

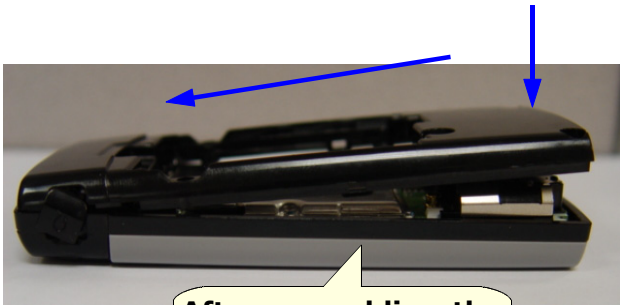

After assembling the lower side, assemble upper side

- 1) After assembling the bottom side, push and assemble the upper side

**\* caution**

- 1) Be careful not to make scratch and molding damage!

18

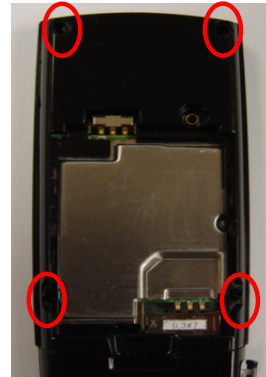

Check SCREW 4 points

- 1) Screw up the REAR at 4 Points. [M1.4\* L3.5]

**\* caution**

- 1) Torque  $0.8 \pm 0.1$  Kgf/cm<sup>2</sup>
- 2) Be careful not to make scratch and molding damage!



## 7. MAIN Electrical Parts List

SEC CODE	Design LOC	Discription	STATUS
0403-001427	ANT100	DIODE-ZENER	SA
0403-001547	BAT300	DIODE-ZENER	SA
0404-001172	BTC104	DIODE-SCHOTTKY	SA
0406-001083	C100	DIODE-TVS	SA
0406-001083	C101	DIODE-TVS	SA
0406-001083	C102	DIODE-TVS	SA
0406-001210	C105	DIODE-TVS	SA
0406-001210	C106	DIODE-TVS	SA
0406-001210	C107	DIODE-TVS	SA
0406-001210	C108	DIODE-TVS	SA
0406-001210	C109	DIODE-TVS	SA
0406-001210	C110	DIODE-TVS	SA
0406-001254	C112	DIODE-TVS	SA
0406-001254	C113	DIODE-TVS	SA
0406-001254	C115	DIODE-TVS	SA
0406-001254	C116	DIODE-TVS	SA
0406-001254	C117	DIODE-TVS	SA
0406-001254	C118	DIODE-TVS	SA
0406-001254	C119	DIODE-TVS	SA
0406-001254	C120	DIODE-TVS	SA
0407-001002	C121	DIODE-ARRAY	SA
0501-000225	C126	TR-SMALL SIGNAL	SA
0504-000168	C127	TR-DIGITAL	SA
0601-001979	C129	LED	SA
0601-001979	C130	LED	SA
0801-002529	C132	IC-CMOS LOGIC	SA
1108-000070	C133	IC-MCP	SA
1201-002364	C134	IC-POWER AMP	SA
1203-003304	C135	IC-POWER SUPERVISOR	SA
1203-003663	C136	IC-BATTERY	SA
1203-003737	C137	IC-POSI.FIXED REG.	SA
1203-004337	C138	IC-DC/DC CONVERTER	SA
1204-001811	C139	IC-MELODY	SA
1205-002683	C140	IC-TRANSCEIVER	SA
1209-001219	C141	IC-SENSOR	SA
1405-001082	C142	VARISTOR	SA
1405-001082	C143	VARISTOR	SA
1405-001082	C146	VARISTOR	SA
1405-001082	C147	VARISTOR	SA
1405-001082	C149	VARISTOR	SA
1405-001082	C150	VARISTOR	SA
1405-001082	C151	VARISTOR	SA
1405-001082	C152	VARISTOR	SA

Main Electrical Parts List

SEC CODE	Design LOC	Discription	STATUS
1405-001082	C153	VARISTOR	SA
1405-001082	C155	VARISTOR	SA
1405-001082	C156	VARISTOR	SA
1405-001093	C158	VARISTOR	SA
2007-000140	C160	R-CHIP	SA
2007-000140	C161	R-CHIP	SA
2007-000142	C162	R-CHIP	SNA
2007-000148	C164	R-CHIP	SA
2007-000148	C165	R-CHIP	SA
2007-000148	C166	R-CHIP	SA
2007-000148	C167	R-CHIP	SA
2007-000157	C168	R-CHIP	SA
2007-000157	C170	R-CHIP	SA
2007-000157	C171	R-CHIP	SA
2007-000157	C172	R-CHIP	SA
2007-000160	C173	R-CHIP	SA
2007-000161	C174	R-CHIP	SA
2007-000161	C175	R-CHIP	SA
2007-000161	C176	R-CHIP	SA
2007-000161	C178	R-CHIP	SA
2007-000162	C179	R-CHIP	SA
2007-000162	C180	R-CHIP	SA
2007-000162	C181	R-CHIP	SA
2007-000162	C182	R-CHIP	SA
2007-000162	C183	R-CHIP	SA
2007-000162	C188	R-CHIP	SA
2007-000164	C198	R-CHIP	SA
2007-000170	C199	R-CHIP	SA
2007-000171	C200	R-CHIP	SA
2007-000171	C201	R-CHIP	SA
2007-000171	C202	R-CHIP	SA
2007-000171	C203	R-CHIP	SA
2007-000171	C204	R-CHIP	SA
2007-000171	C205	R-CHIP	SA
2007-000172	C206	R-CHIP	SA
2007-000172	C207	R-CHIP	SA
2007-000172	C208	R-CHIP	SA
2007-000566	C209	R-CHIP	SA
2007-000566	C210	R-CHIP	SA
2007-000566	C211	R-CHIP	SA
2007-000566	C212	R-CHIP	SA
2007-000775	C213	R-CHIP	SA
2007-000775	C214	R-CHIP	SA

SEC CODE	Design LOC	Discription	STATUS
2007-000775	C215	R-CHIP	SA
2007-000831	C216	R-CHIP	SA
2007-000831	C217	R-CHIP	SA
2007-001119	C220	R-CHIP	SA
2007-001308	C222	R-CHIP	SA
2007-001320	C223	R-CHIP	SA
2007-001320	C225	R-CHIP	SA
2007-001323	C226	R-CHIP	SA
2007-001325	C227	R-CHIP	SA
2007-002797	C228	R-CHIP	SA
2007-002965	C229	R-CHIP	SA
2007-002965	C230	R-CHIP	SA
2007-002965	C233	R-CHIP	SA
2007-002965	D200	R-CHIP	SA
2007-002965	D201	R-CHIP	SA
2007-007197	EAR102	R-CHIP	SA
2007-007197	F101	R-CHIP	SA
2007-007573	F102	R-CHIP	SA
2007-007573	GND101	R-CHIP	SA
2007-008137	IFC101	R-CHIP	SA
2007-008419	L100	R-CHIP	SA
2007-008419	L101	R-CHIP	SA
2007-008419	L102	R-CHIP	SA
2007-008419	L104	R-CHIP	SA
2007-008419	L105	R-CHIP	SA
2007-008419	L110	R-CHIP	SA
2007-008419	L111	R-CHIP	SA
2007-008419	L200	R-CHIP	SA
2007-008419	LED200	R-CHIP	SA
2007-008419	LED201	R-CHIP	SA
2007-008419	OSC100	R-CHIP	SA
2007-008419	OSC200	R-CHIP	SA
2007-008486	PAM100	R-CHIP	SA
2007-008516	R104	R-CHIP	SA
2007-008516	R105	R-CHIP	SA
2007-008590	R107	R-CHIP	SNA
2007-009160	R108	R-CHIP	SA
2007-009171	R111	R-CHIP	SA
2203-000233	R112	C-CER,CHIP	SA
2203-000233	R113	C-CER,CHIP	SA
2203-000233	R114	C-CER,CHIP	SA
2203-000233	R115	C-CER,CHIP	SA
2203-000233	R116	C-CER,CHIP	SA

Main Electrical Parts List

SEC CODE	Design LOC	Discription	STATUS
2203-000254	R117	C-CER,CHIP	SA
2203-000254	R118	C-CER,CHIP	SA
2203-000254	R120	C-CER,CHIP	SA
2203-000254	R121	C-CER,CHIP	SA
2203-000254	R122	C-CER,CHIP	SA
2203-000254	R123	C-CER,CHIP	SA
2203-000254	R128	C-CER,CHIP	SA
2203-000254	R131	C-CER,CHIP	SA
2203-000254	R133	C-CER,CHIP	SA
2203-000254	R135	C-CER,CHIP	SA
2203-000254	R137	C-CER,CHIP	SA
2203-000359	R138	C-CER,CHIP	SA
2203-000359	R139	C-CER,CHIP	SA
2203-000386	R140	C-CER,CHIP	SA
2203-000386	R142	C-CER,CHIP	SA
2203-000386	R143	C-CER,CHIP	SA
2203-000438	R144	C-CER,CHIP	SA
2203-000654	R145	C-CER,CHIP	SA
2203-000679	R146	C-CER,CHIP	SA
2203-000812	R147	C-CER,CHIP	SA
2203-000812	R150	C-CER,CHIP	SA
2203-000812	R151	C-CER,CHIP	SA
2203-000940	R152	C-CER,CHIP	SA
2203-000995	R153	C-CER,CHIP	SA
2203-000995	R155	C-CER,CHIP	SA
2203-000995	R156	C-CER,CHIP	SA
2203-001072	R157	C-CER,CHIP	SA
2203-001405	R158	C-CER,CHIP	SA
2203-001412	R159	C-CER,CHIP	SA
2203-005344	R168	C-CER,CHIP	SA
2203-005344	R170	C-CER,CHIP	SA
2203-005344	R171	C-CER,CHIP	SA
2203-005682	R172	C-CER,CHIP	SA
2203-005682	R179	C-CER,CHIP	SA
2203-005682	R180	C-CER,CHIP	SA
2203-005682	R181	C-CER,CHIP	SA
2203-005736	R182	C-CER,CHIP	SA
2203-005736	R183	C-CER,CHIP	SA
2203-005736	R184	C-CER,CHIP	SA
2203-005792	R185	C-CER,CHIP	SA
2203-005792	R186	C-CER,CHIP	SA
2203-005819	R190	C-CER,CHIP	SA
2203-005819	R191	C-CER,CHIP	SA

SEC CODE	Design LOC	Discription	STATUS
2203-005819	R192	C-CER,CHIP	SA
2203-005819	R193	C-CER,CHIP	SA
2203-005819	R194	C-CER,CHIP	SA
2203-005993	R195	C-CER,CHIP	SNA
2203-005993	R196	C-CER,CHIP	SNA
2203-006048	R197	C-CER,CHIP	SA
2203-006048	R198	C-CER,CHIP	SA
2203-006048	R199	C-CER,CHIP	SA
2203-006048	R200	C-CER,CHIP	SA
2203-006048	R201	C-CER,CHIP	SA
2203-006048	R204	C-CER,CHIP	SA
2203-006048	R206	C-CER,CHIP	SA
2203-006048	R207	C-CER,CHIP	SA
2203-006048	R209	C-CER,CHIP	SA
2203-006048	R214	C-CER,CHIP	SA
2203-006048	R216	C-CER,CHIP	SA
2203-006048	R243	C-CER,CHIP	SA
2203-006194	R244	C-CER,CHIP	SA
2203-006194	R245	C-CER,CHIP	SA
2203-006257	R247	C-CER,CHIP	SA
2203-006260	R249	C-CER,CHIP	SA
2203-006260	R250	C-CER,CHIP	SA
2203-006260	R251	C-CER,CHIP	SA
2203-006260	RFS100	C-CER,CHIP	SA
2203-006318	SIM103	C-CER,CHIP	SA
2203-006318	TA101	C-CER,CHIP	SA
2203-006318	TA102	C-CER,CHIP	SA
2203-006324	TA103	C-CER,CHIP	SA
2203-006348	TA104	C-CER,CHIP	SA
2203-006423	TA105	C-CER,CHIP	SA
2203-006423	TA106	C-CER,CHIP	SA
2203-006423	TA107	C-CER,CHIP	SA
2203-006423	TA108	C-CER,CHIP	SA
2203-006423	TA109	C-CER,CHIP	SA
2203-006556	TR103	C-CER,CHIP	SA
2203-006556	TR104	C-CER,CHIP	SA
2203-006562	U102	C-CER,CHIP	SA
2203-006562	U105	C-CER,CHIP	SA
2203-006562	U106	C-CER,CHIP	SA
2203-006562	U109	C-CER,CHIP	SA
2203-006562	U202	C-CER,CHIP	SA
2203-006626	U203	C-CER,CHIP	SA
2203-006626	U204	C-CER,CHIP	SA

Main Electrical Parts List

SEC CODE	Design LOC	Discription	STATUS
2203-006648	UCP101	C-CER,CHIP	SA
2203-006824	UCP201	C-CER,CHIP	SA
2404-001225	UME200	C-TA,CHIP	SA
2404-001225	VR112	C-TA,CHIP	SA
2404-001339	VR118	C-TA,CHIP	SA
2404-001343	VR119	C-TA,CHIP	SA
2404-001374	VR203	C-TA,CHIP	SA
2404-001381	VR204	C-TA,CHIP	SA
2404-001381	VR205	C-TA,CHIP	SA
2404-001406	VR206	C-TA,CHIP	SA
2404-001414	VR207	C-TA,CHIP	SA
2503-001053	VR208	C-NETWORK	SA
2503-001053	VR209	C-NETWORK	SA
2503-001053	VR210	C-NETWORK	SA
2703-002313	VR212	INDUCTOR-SMD	SA
2703-002346	ZD112	INDUCTOR-SMD	SA
2703-002485	ZD114	INDUCTOR-SMD	SA
2703-002558	ZD115	INDUCTOR-SMD	SA
2703-002603	ZD116	INDUCTOR-SMD	SA
2703-002842	ZD117	INDUCTOR-SMD	SA
2703-002842	ZD118	INDUCTOR-SMD	SA
2801-004426	ZD119	CRYSTAL-SMD	SA
2801-004466	ZD121	CRYSTAL-SMD	SA
2904-001592	ZD122	FILTER-SAW	SA
2904-001599	ZD123	FILTER-SAW	SA
3705-001358	ZD124	CONNECTOR-COAXIAL	SA
3709-001384	ZD125	CONNECTOR-CARD EDGE	SA
3710-001611	ZD126	CONNECTOR-INTERFACE	SA
3711-006228	ZD127	HEADER-BATTERY	SA
3722-002067	ZD214	JACK-EAR PHONE	SA
4302-001130	ZD215	BATTERY-LI(2ND)	SA
GH09-00036A	ZD216	IC MICOM-SGHX480	SA
GH71-05646A	ZD217	NPR-ANTENNA CONTACT	SA
GH71-05646A	ZD218	NPR-ANTENNA CONTACT	SA

# 8. Block Diagrams

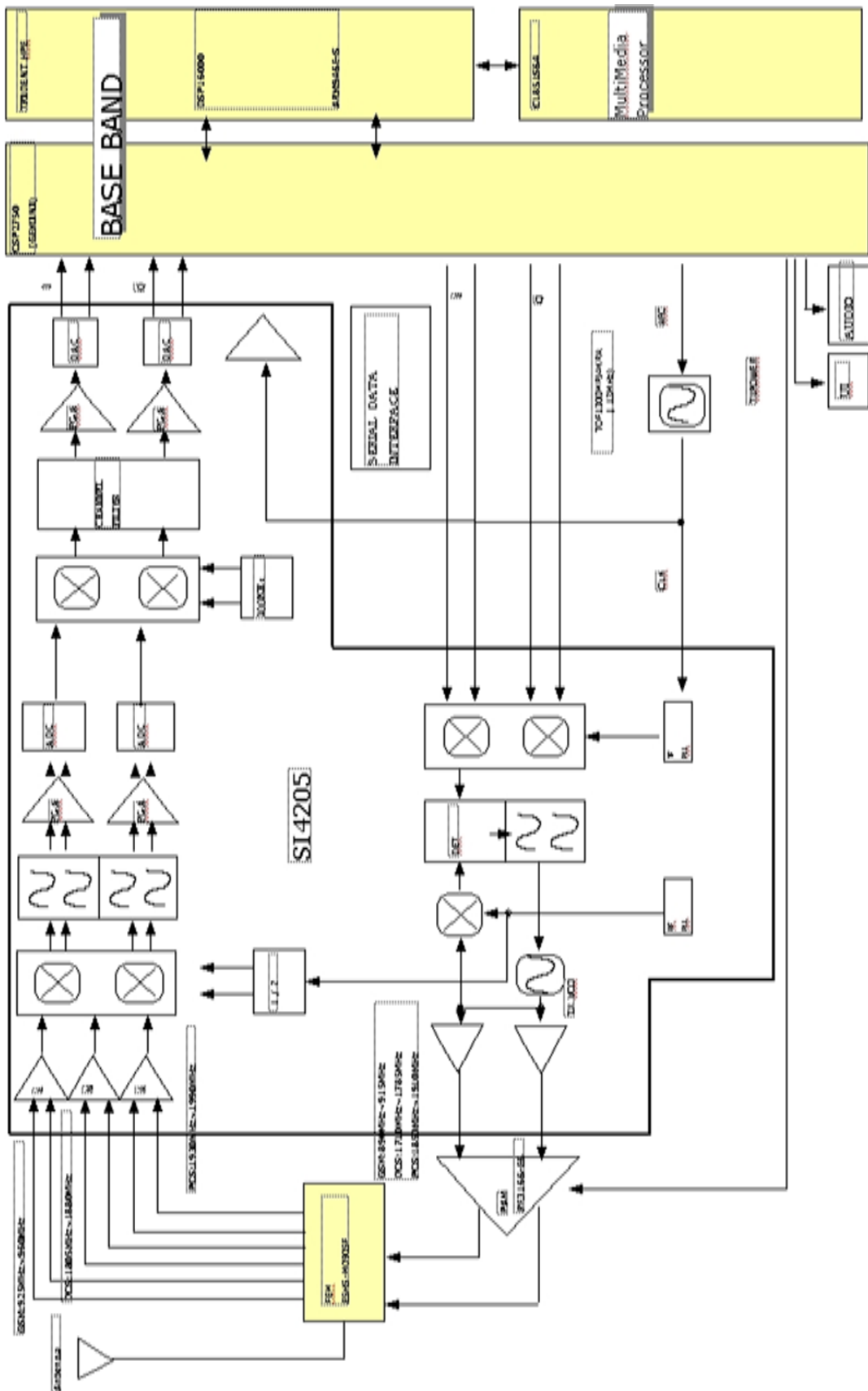

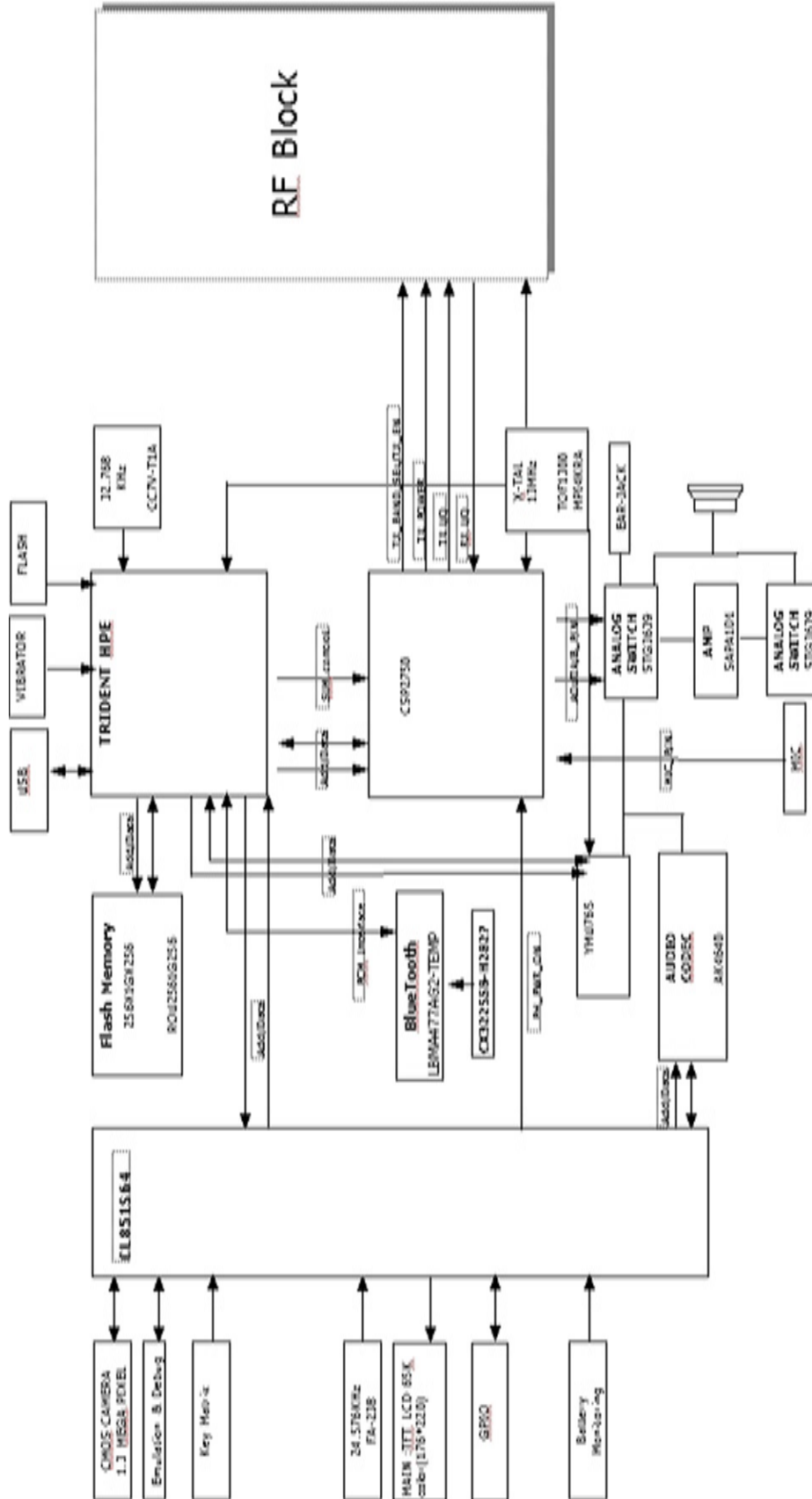



# 9. PCB Diagrams

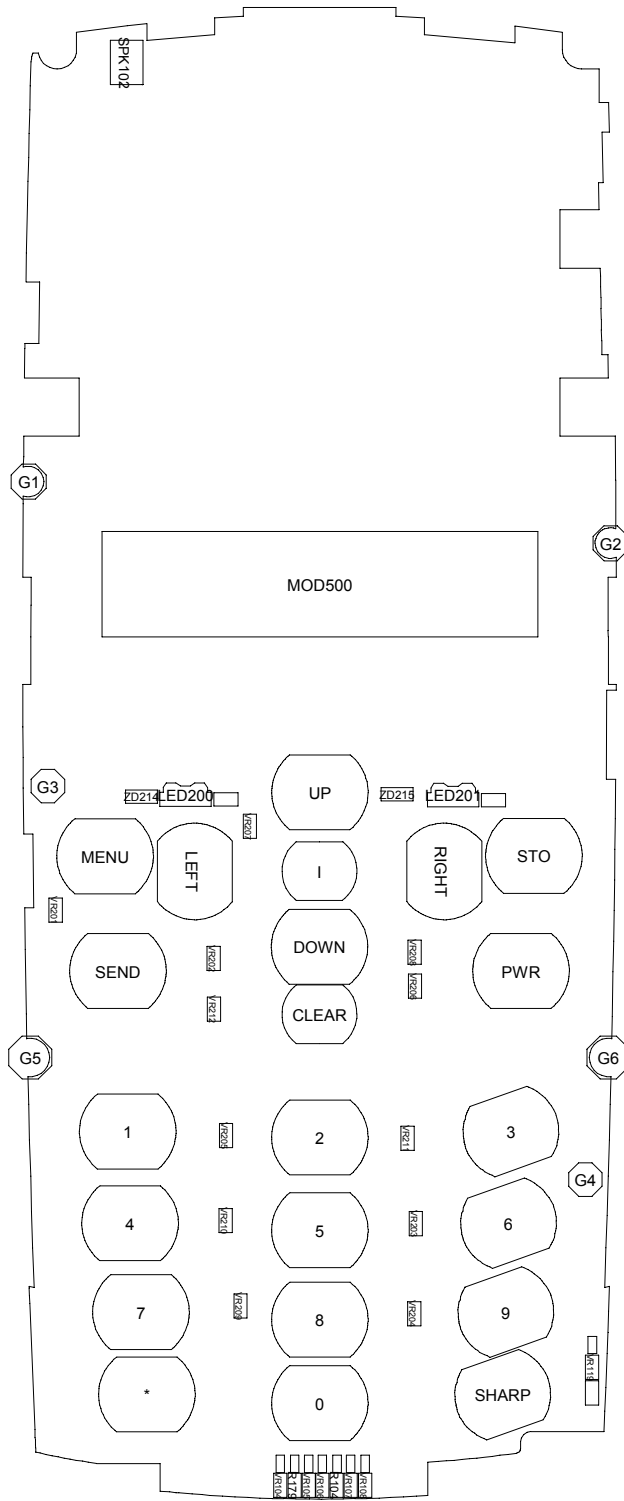

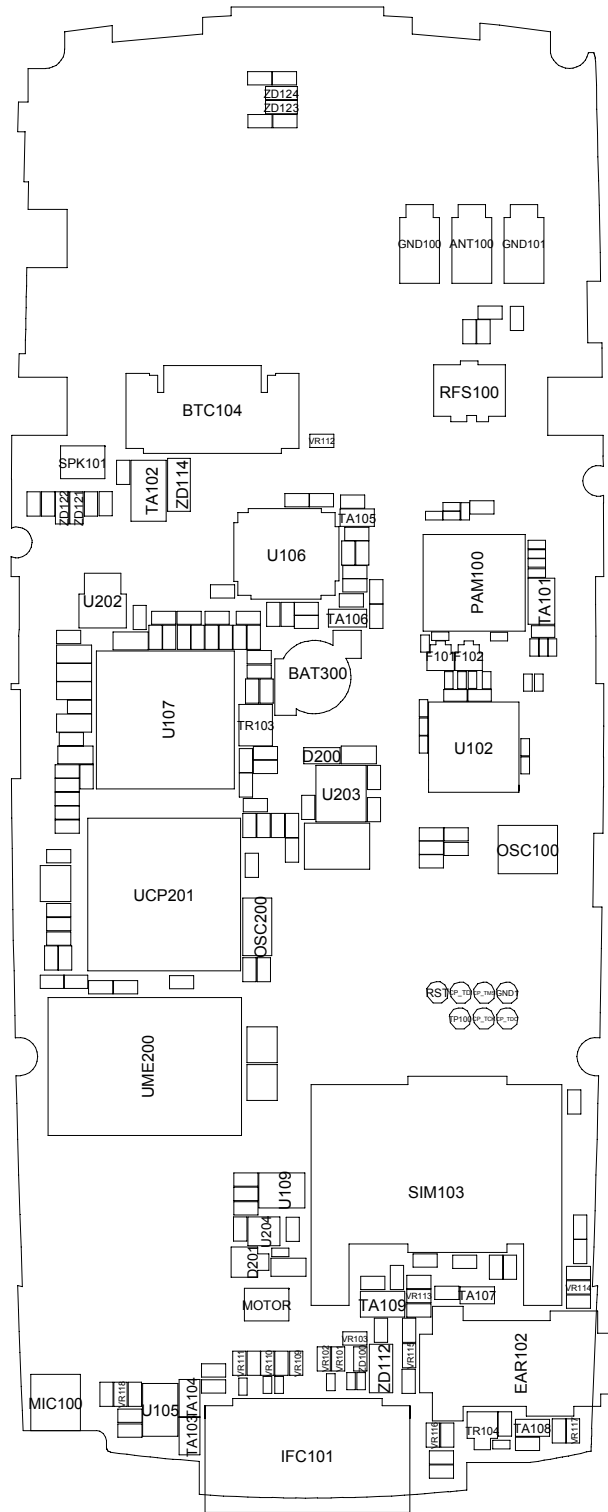

# 10. Flow Chart of Troubleshooting

## 10-1. Baseband

### 10-1-1. Power ON

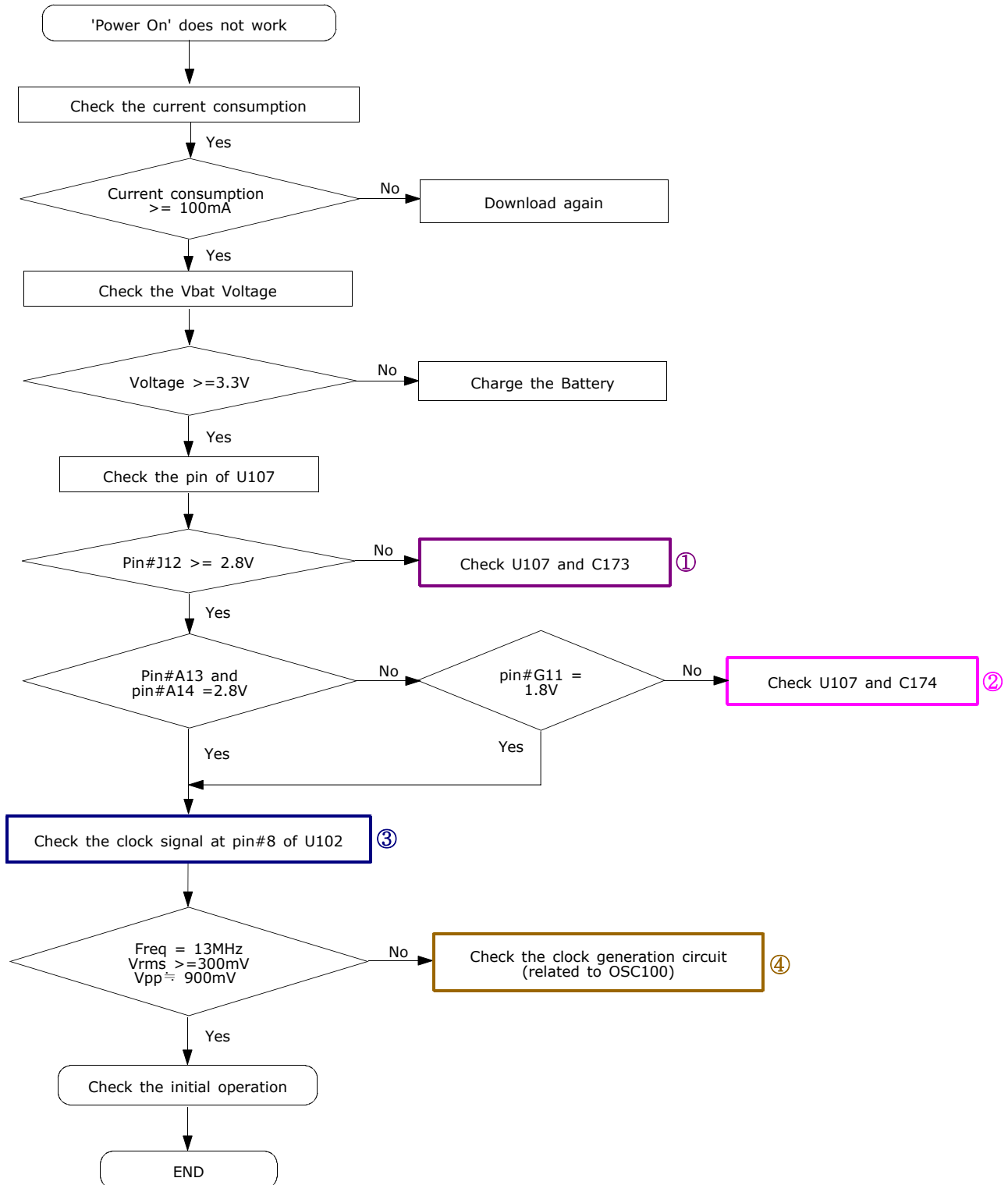

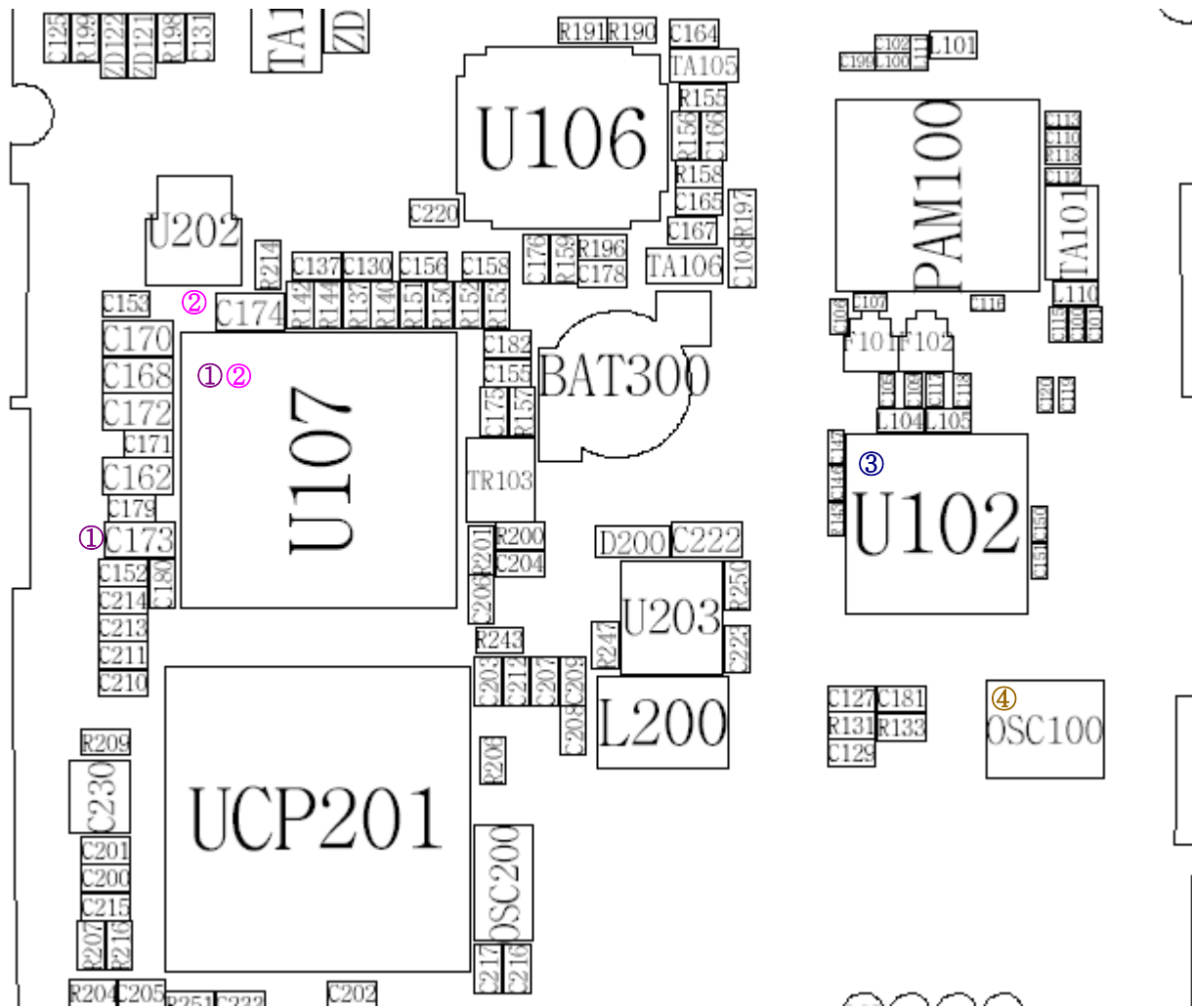

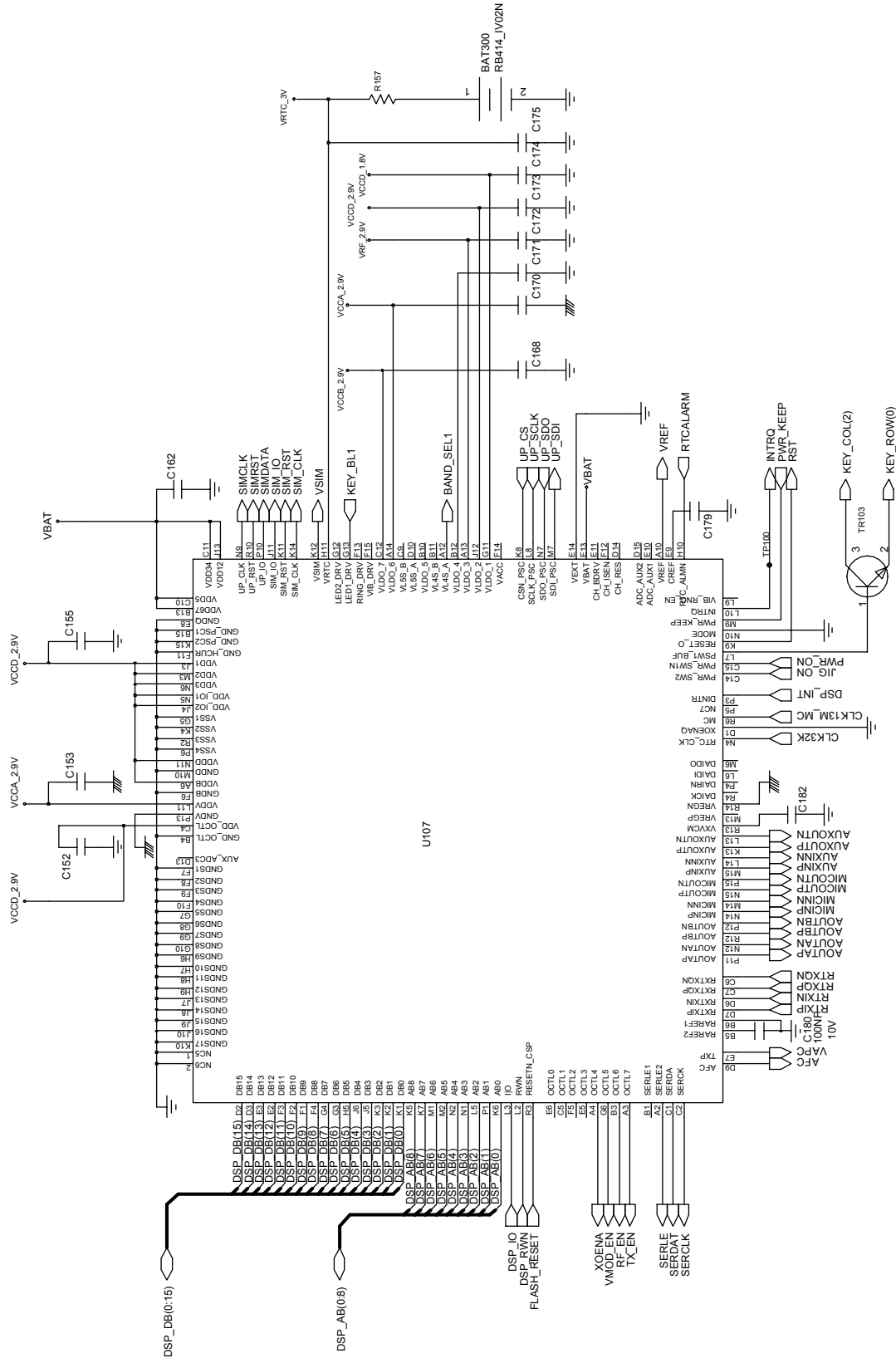

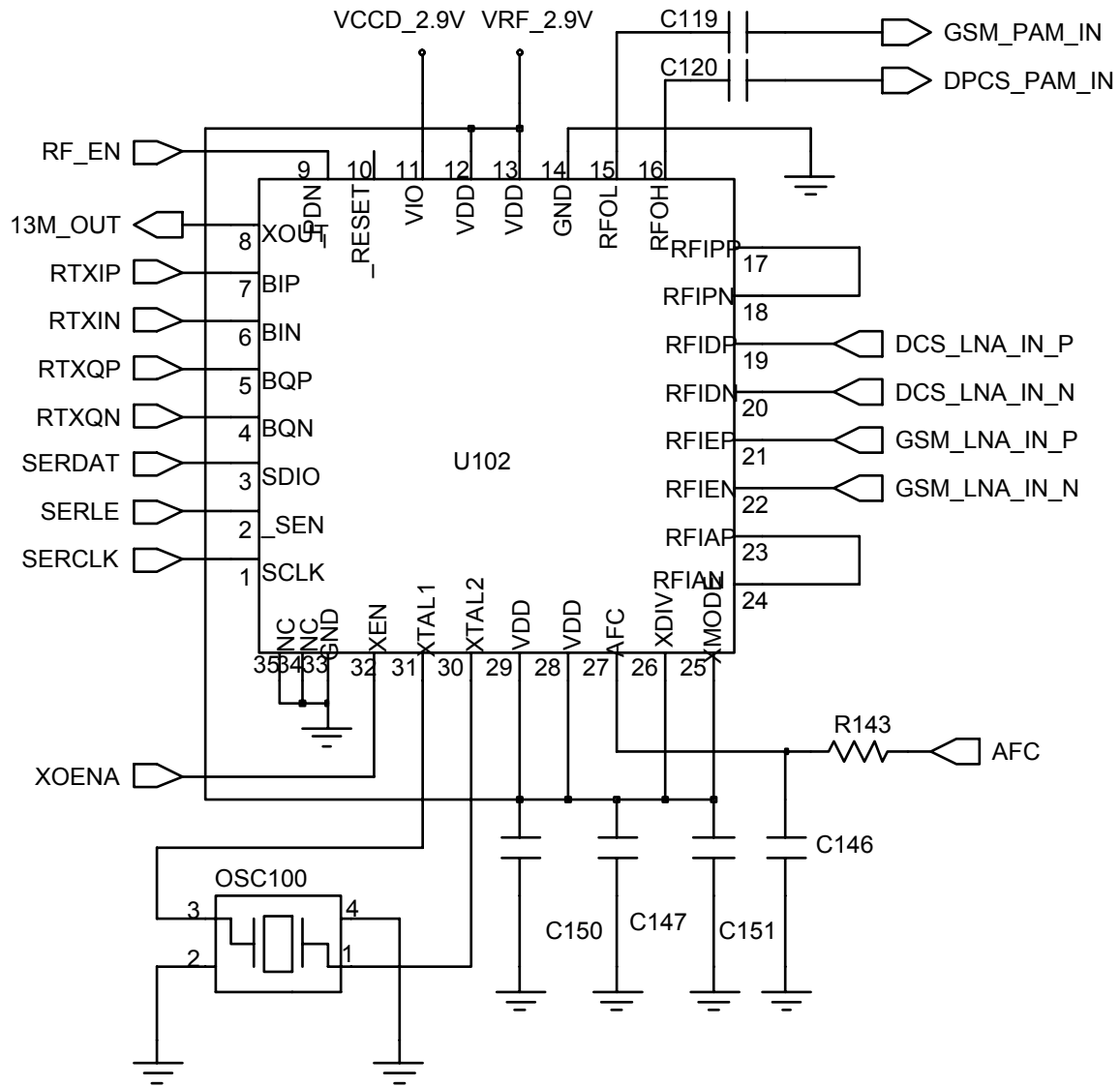

### 10-1-2. Initial

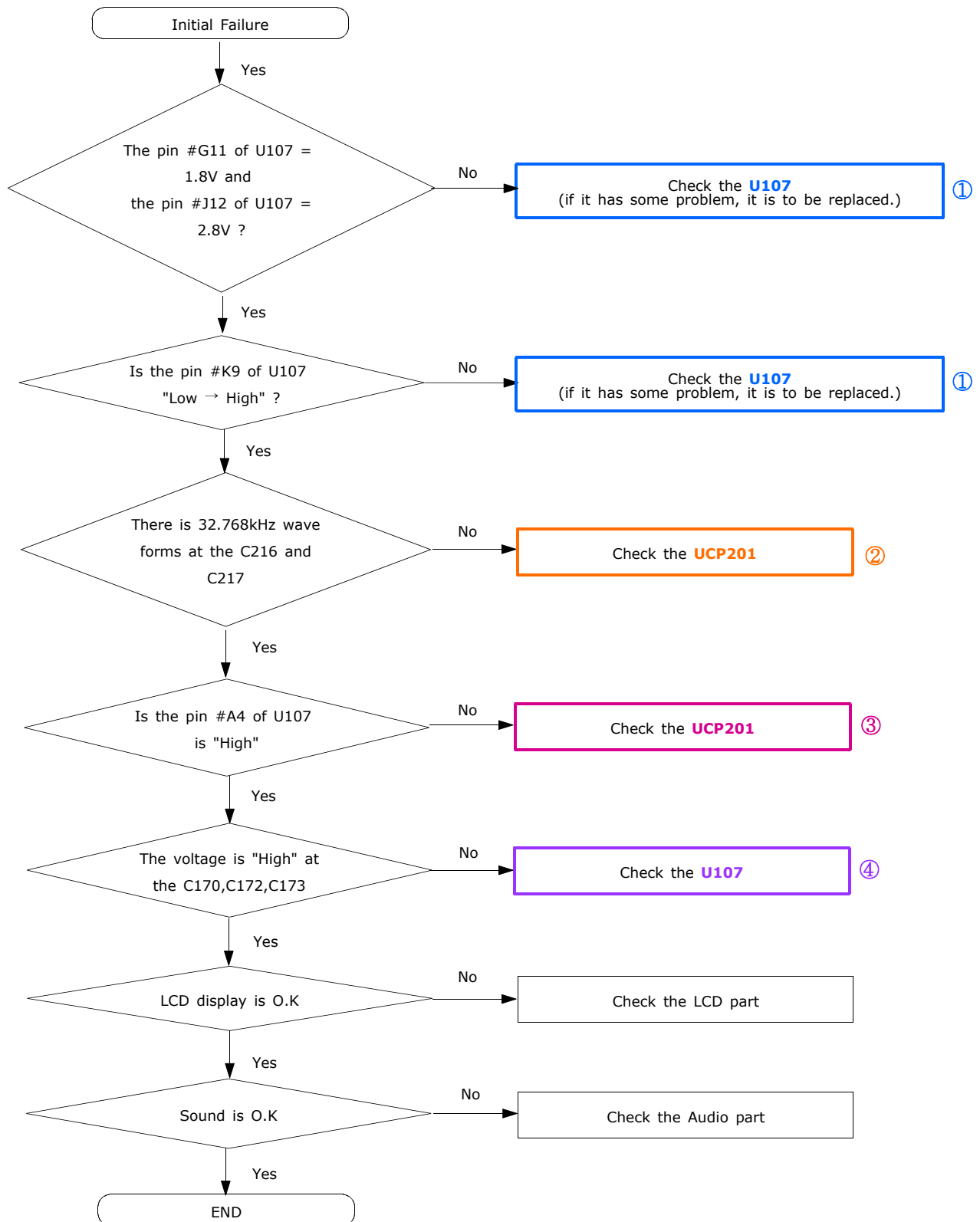

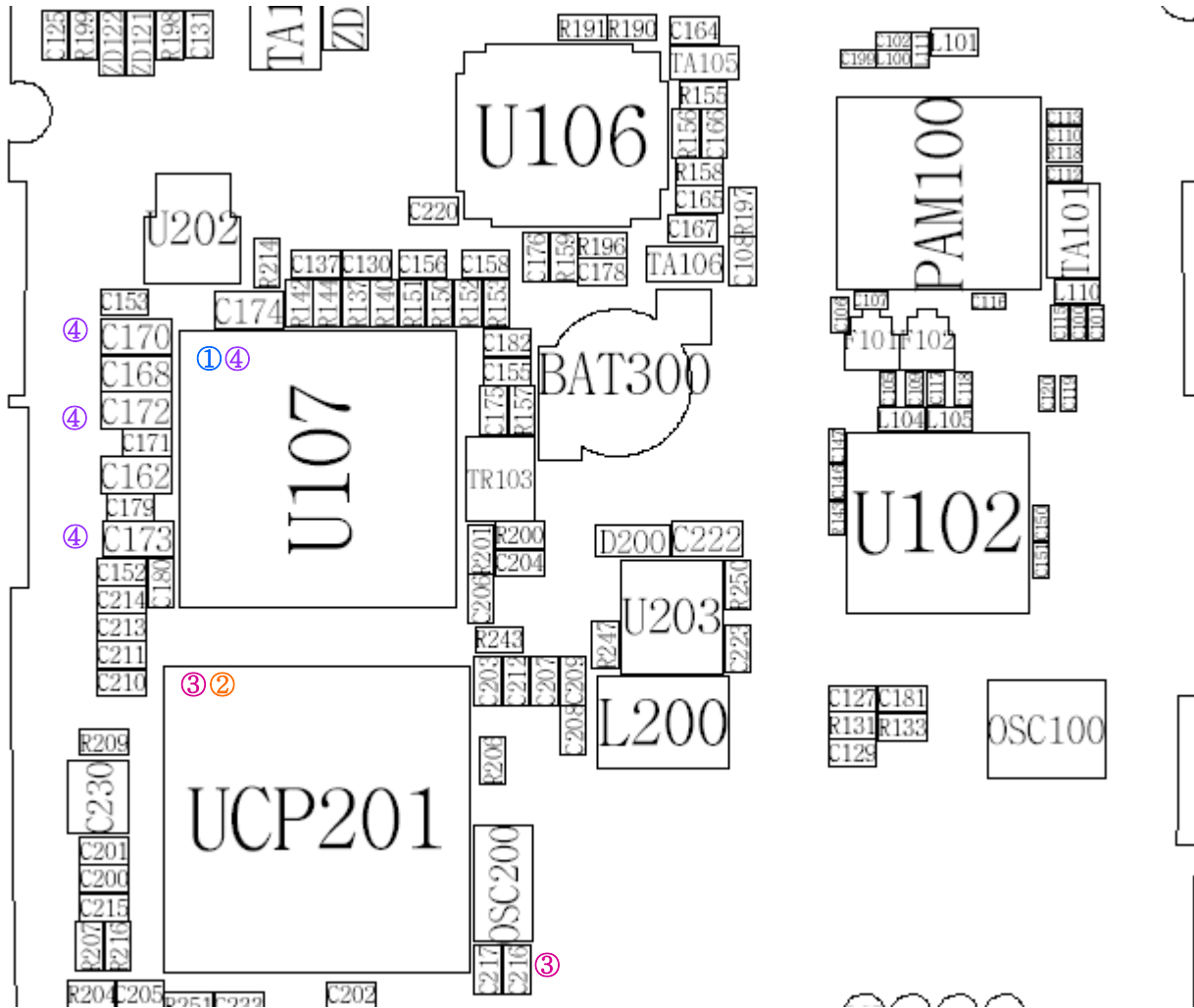



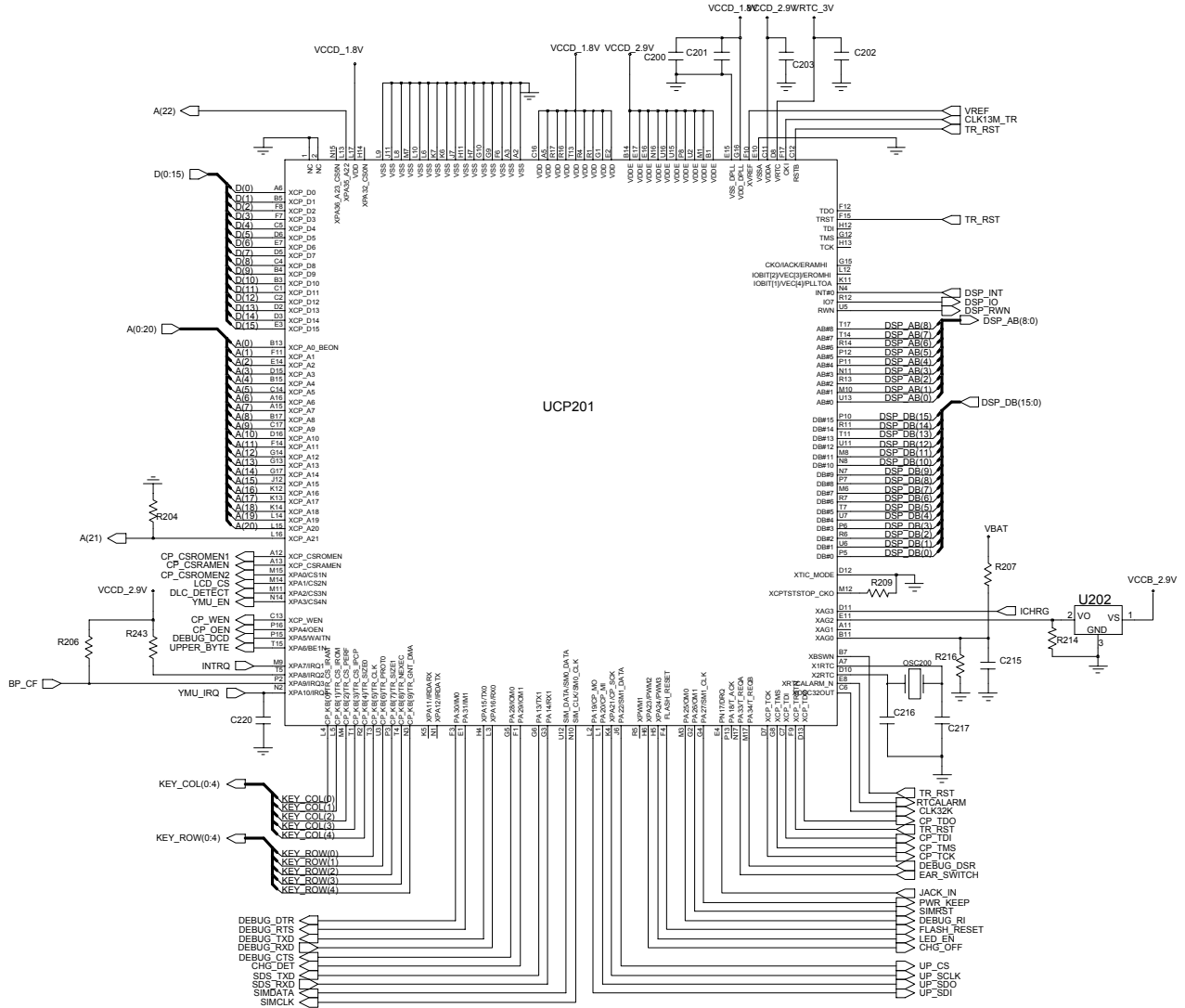

### 10-1-3. Sim Part

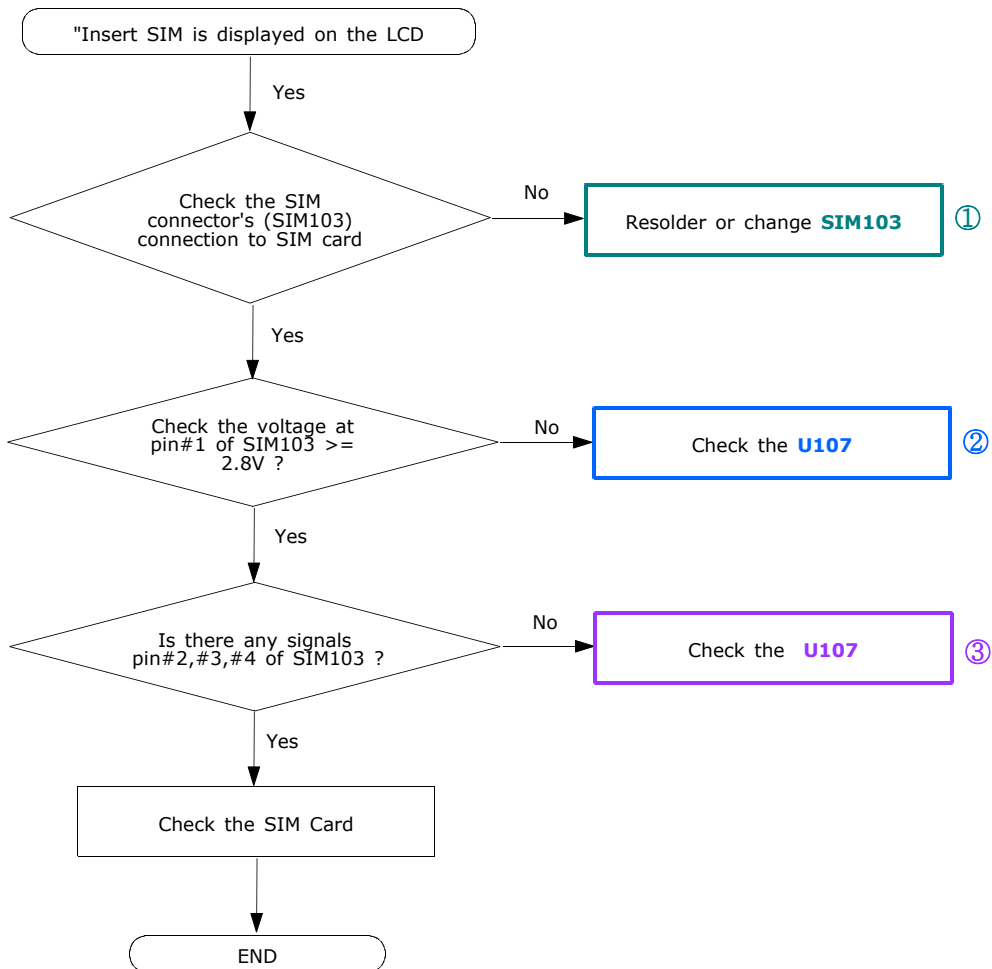

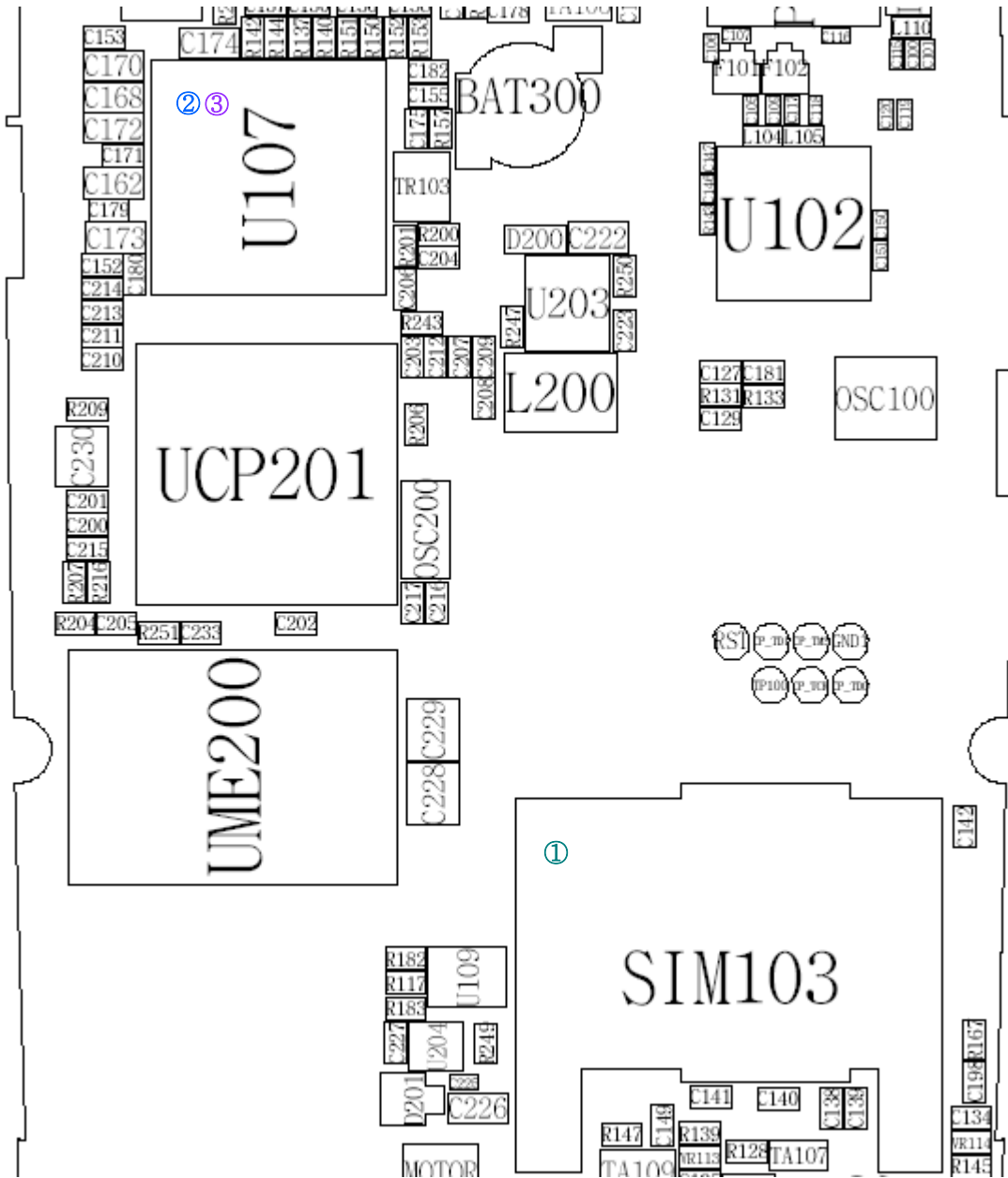

### 10-1-4. Microphone Part

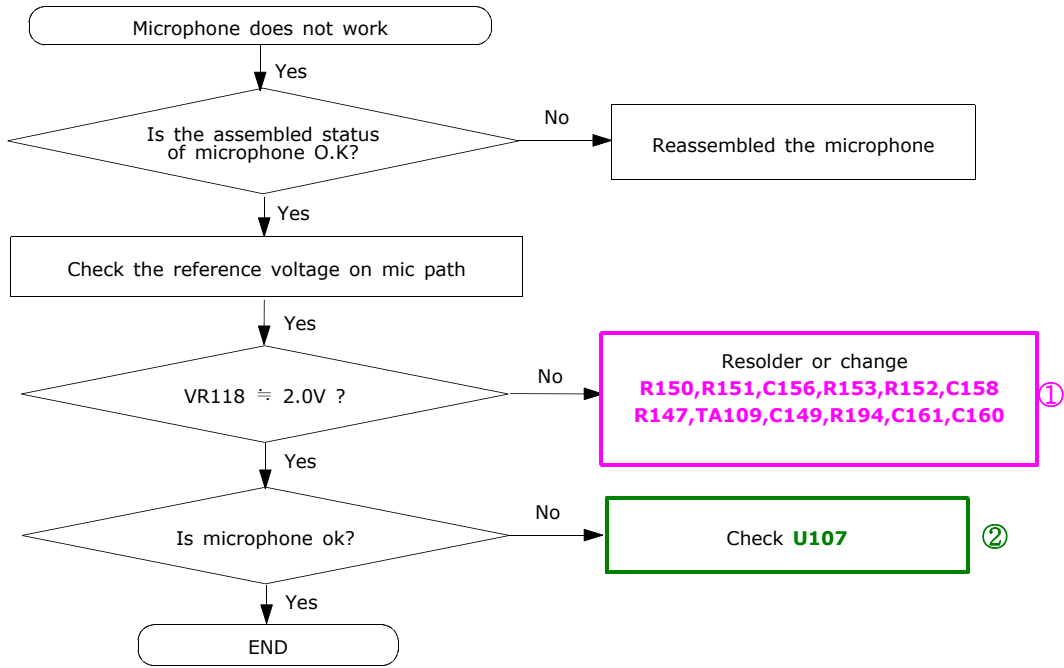

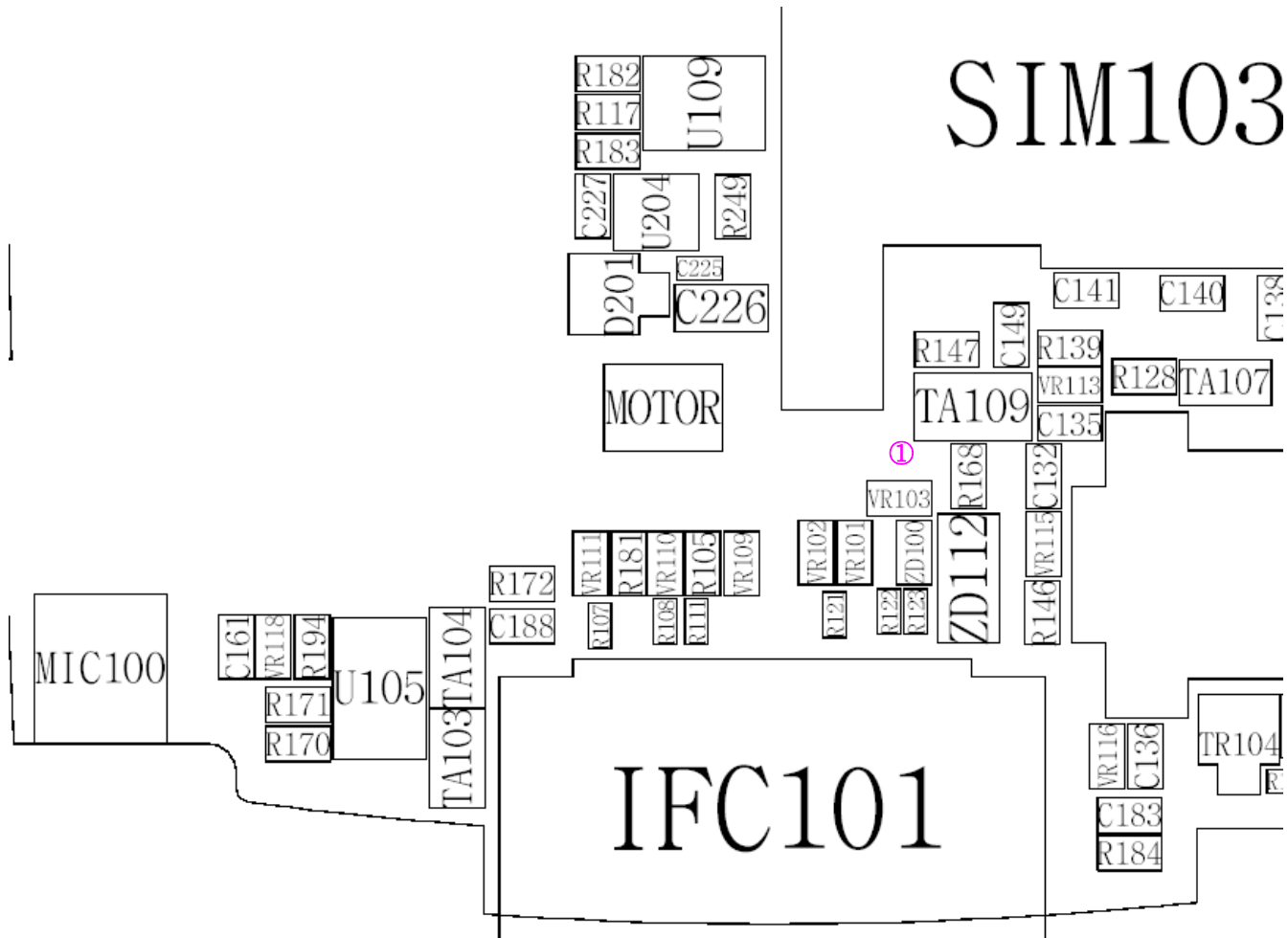

### 10-1-5. Receiver Part

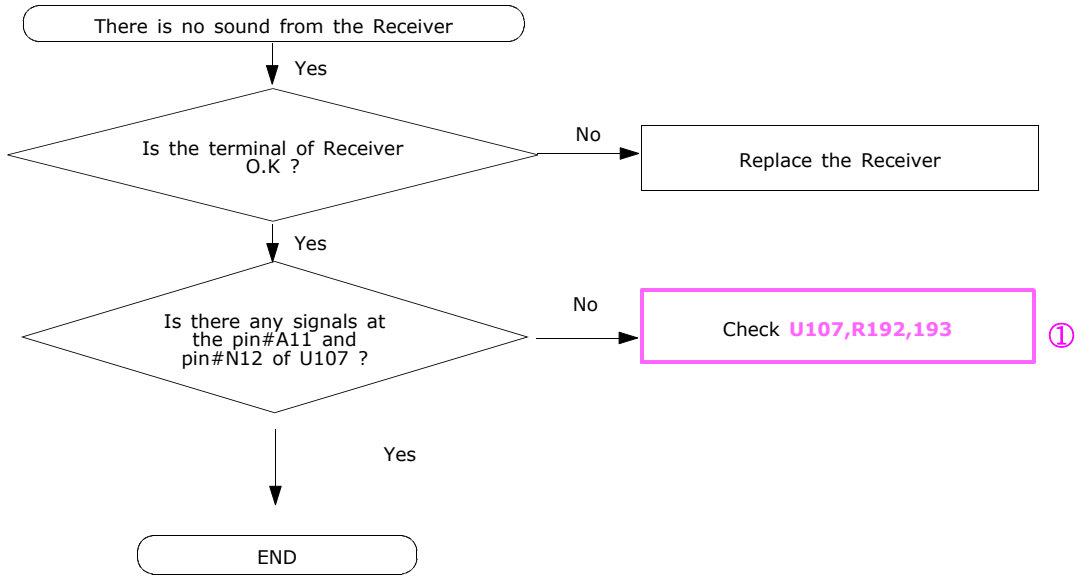

### 10-1-6. Speaker Part

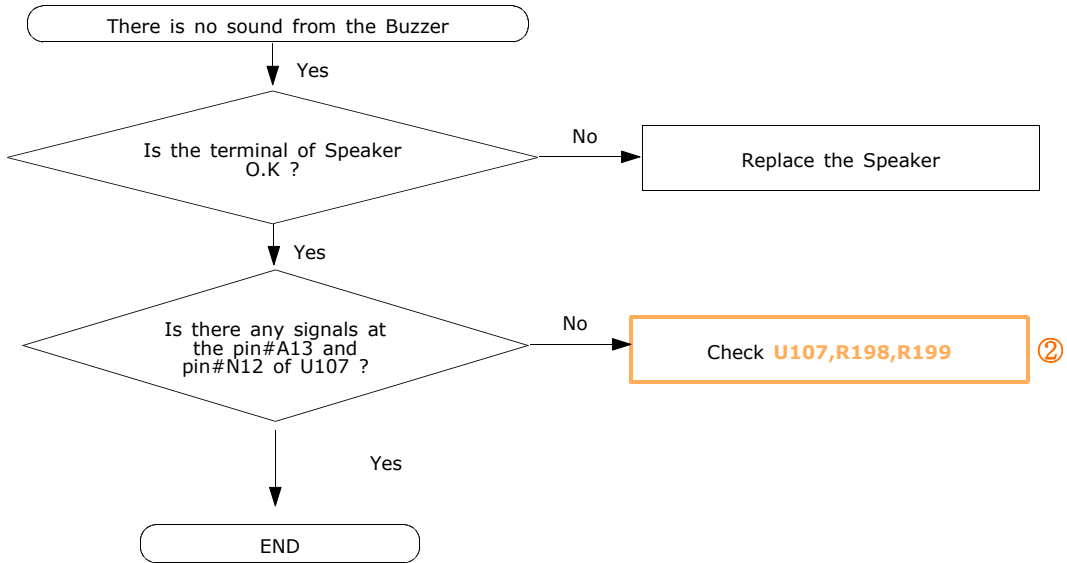

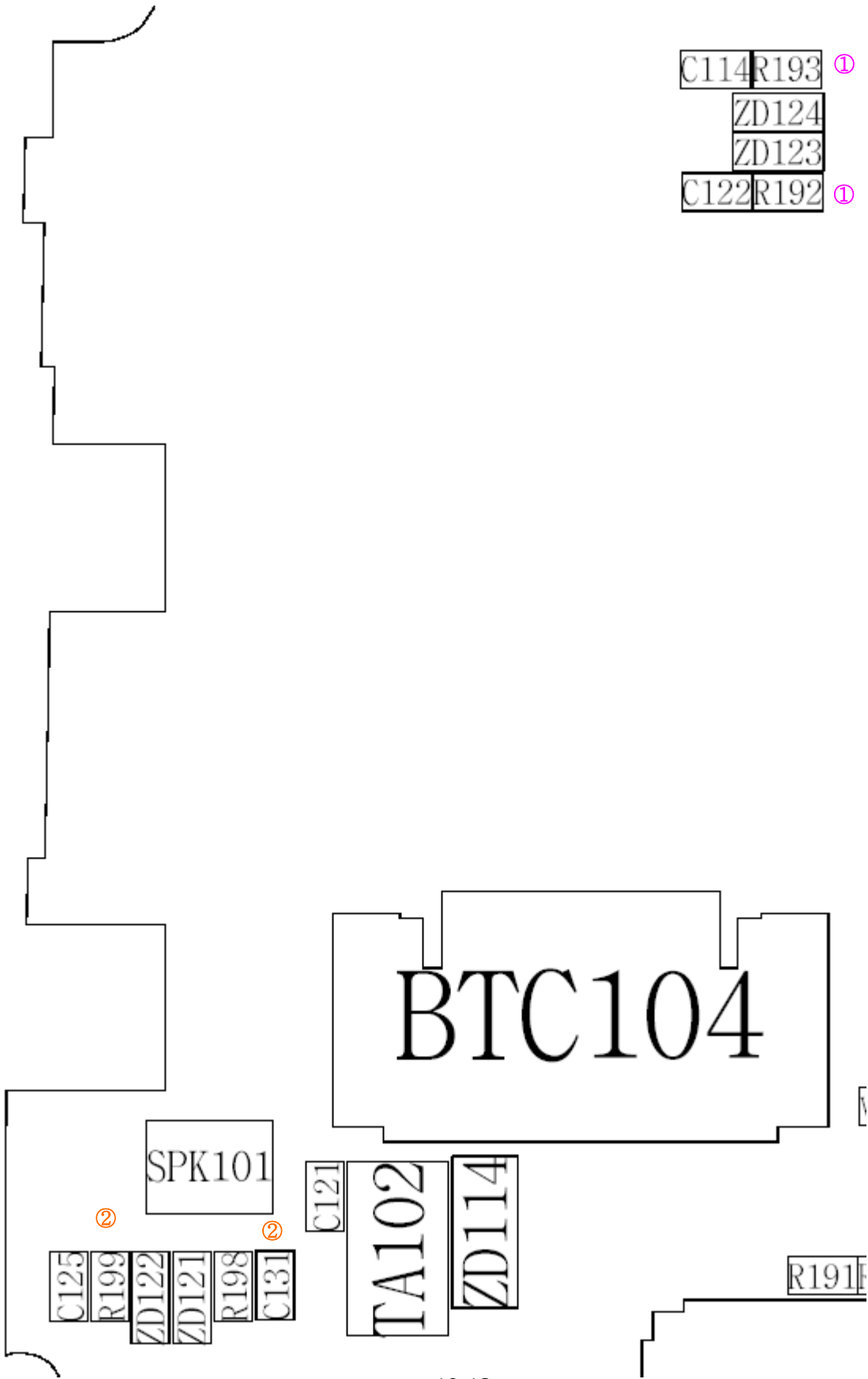

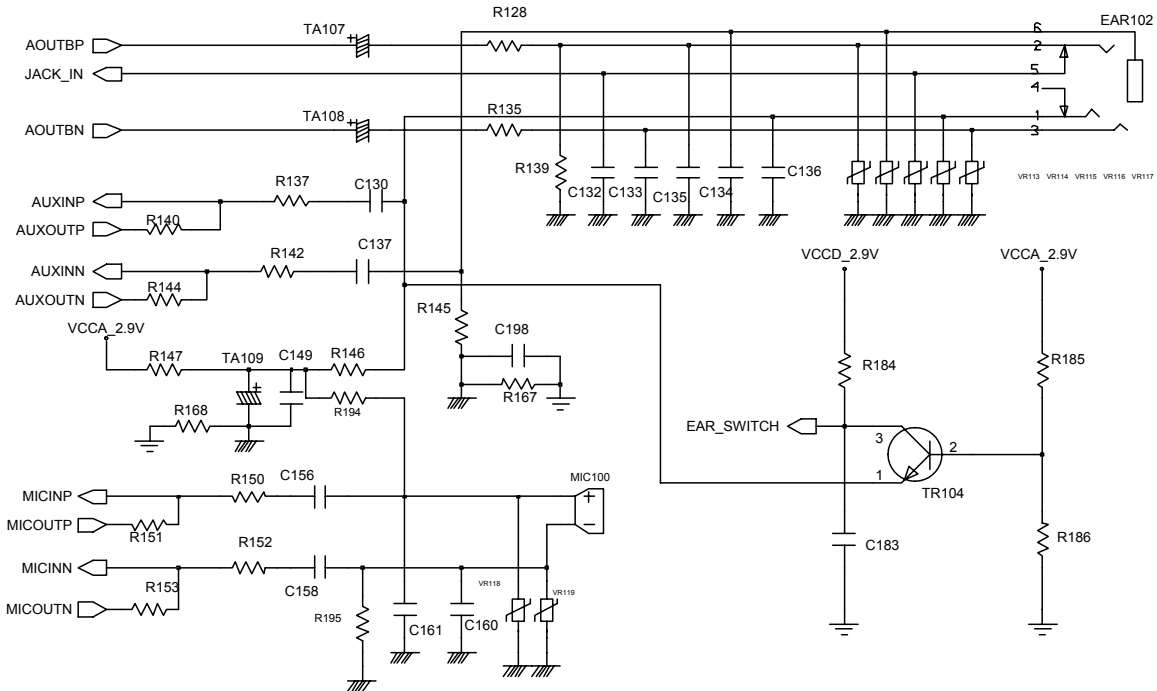
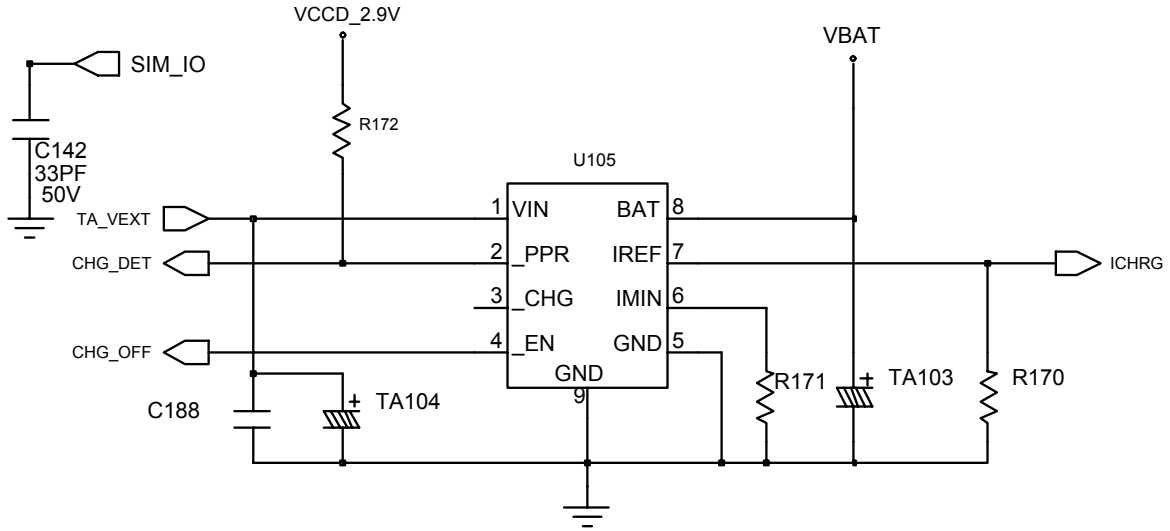



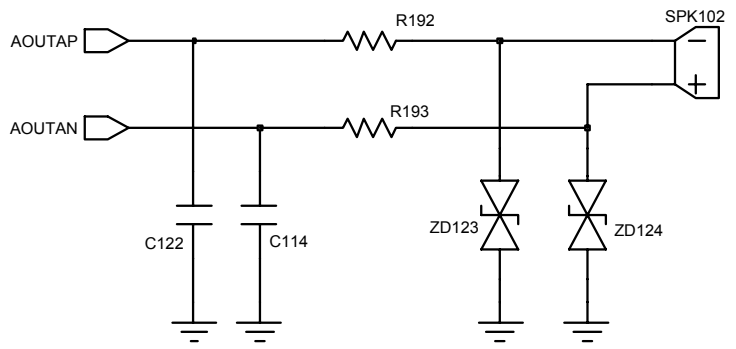
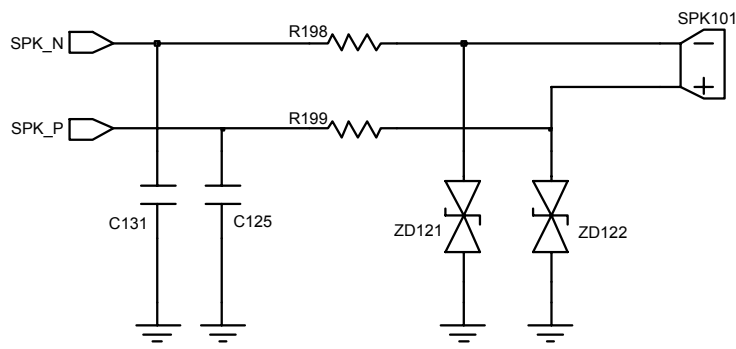
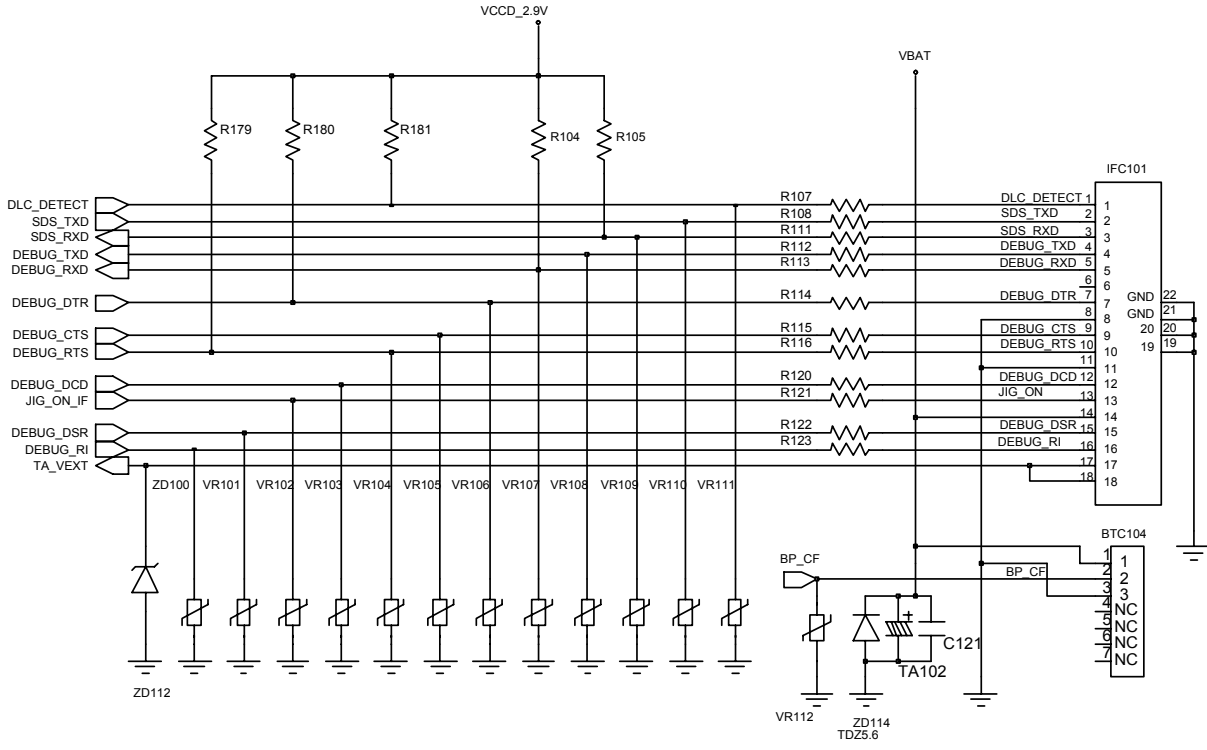

# 10-2.RF

## 10-2-1. EGSM RX

CONTINUOUS RX ON  
RF INPUT : 62CH  
AMP : -50dBm

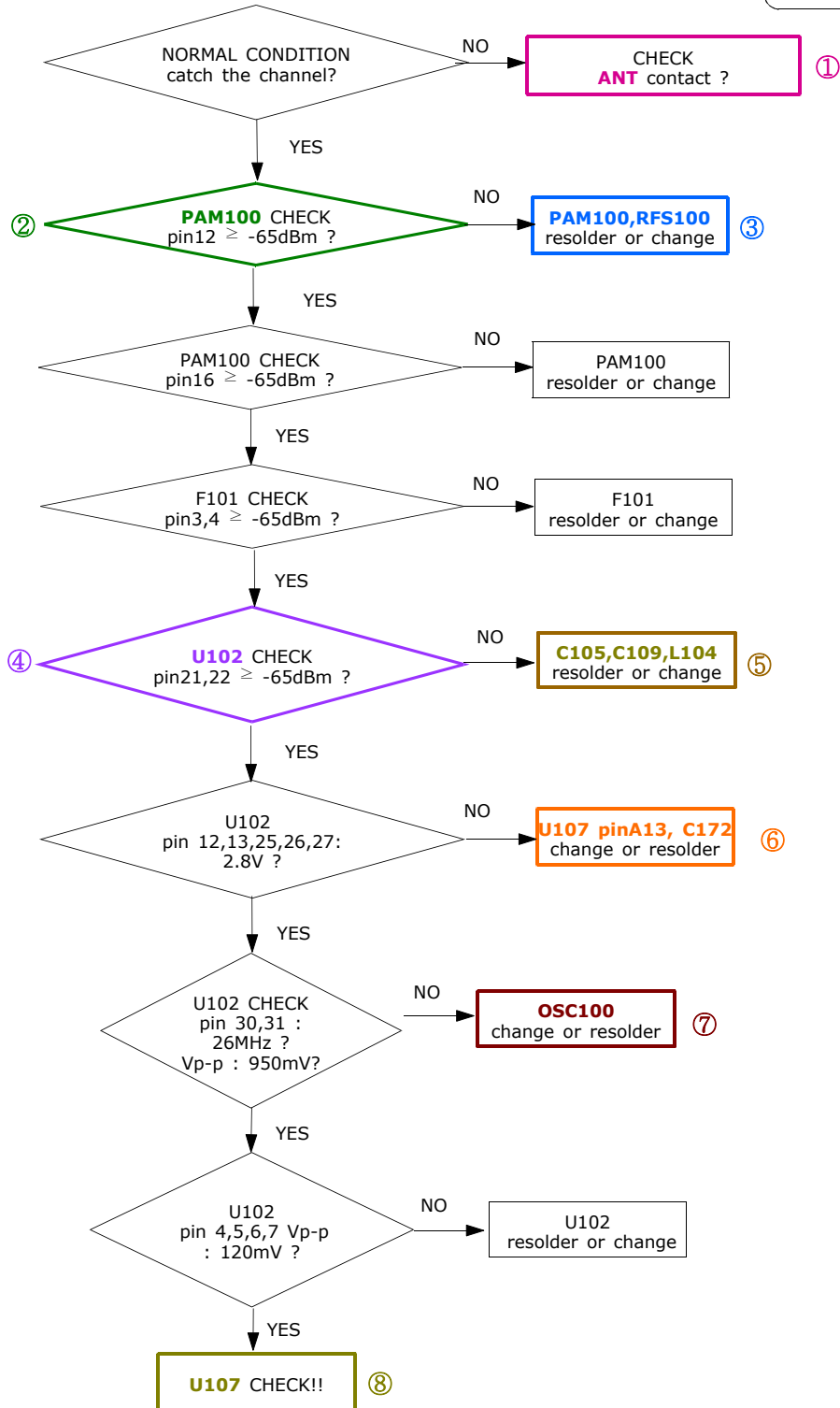

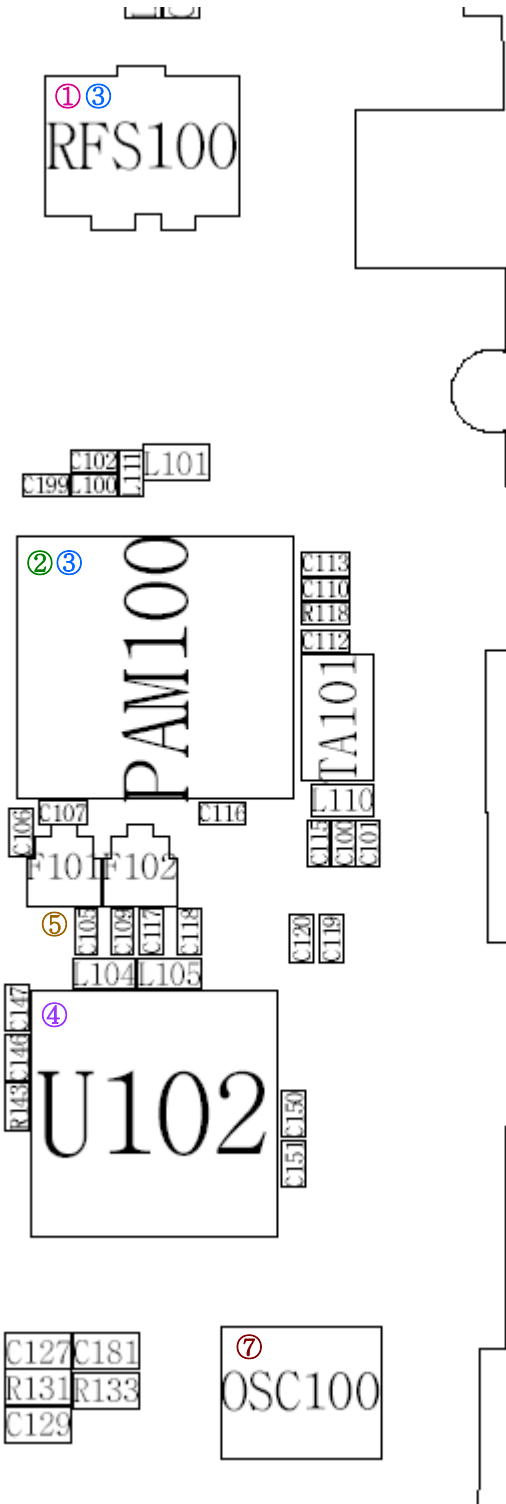

### 10-2-2. DCS RX

CONTINUOUS RX ON  
RF INPUT : 698CH  
AMP : -50dBm

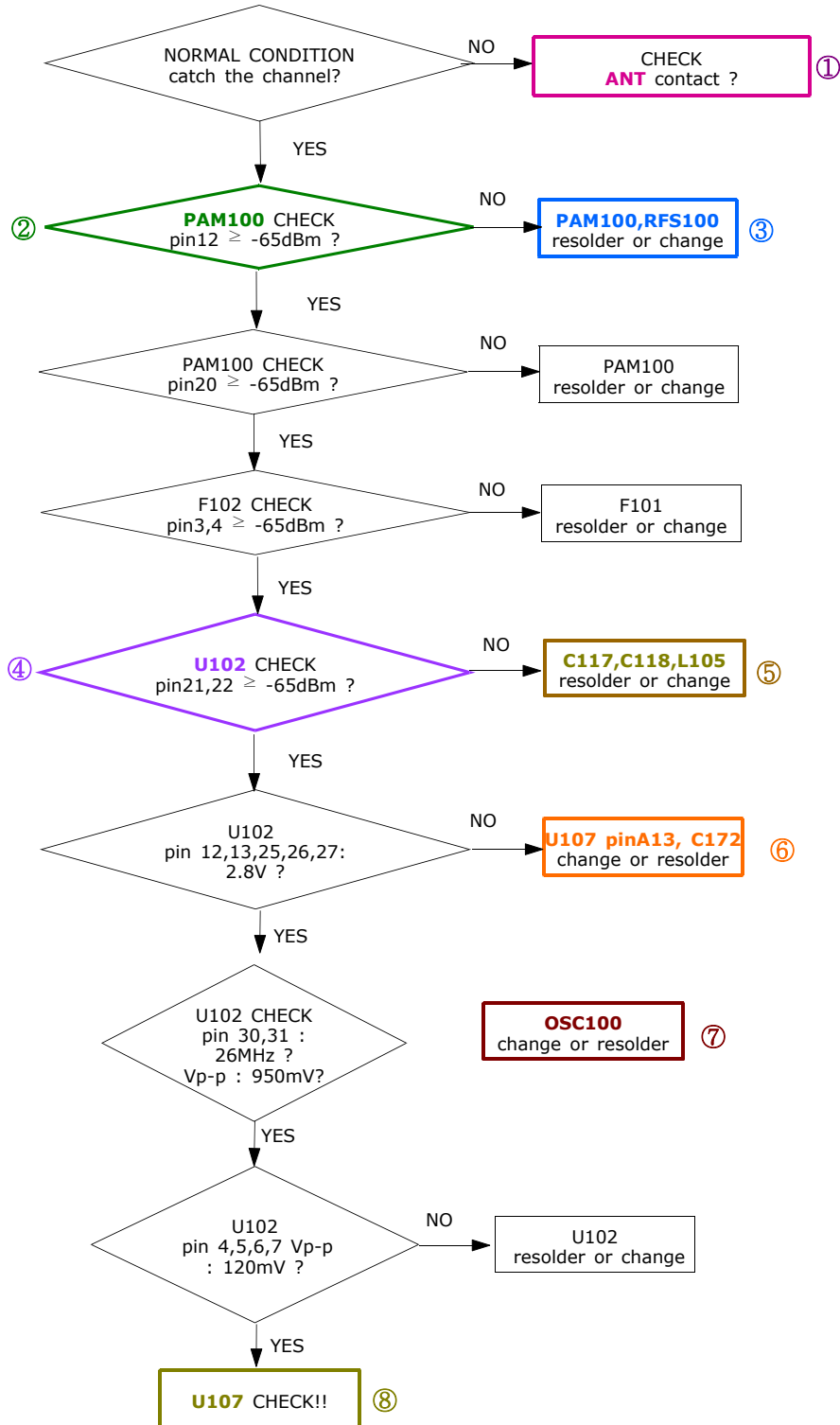

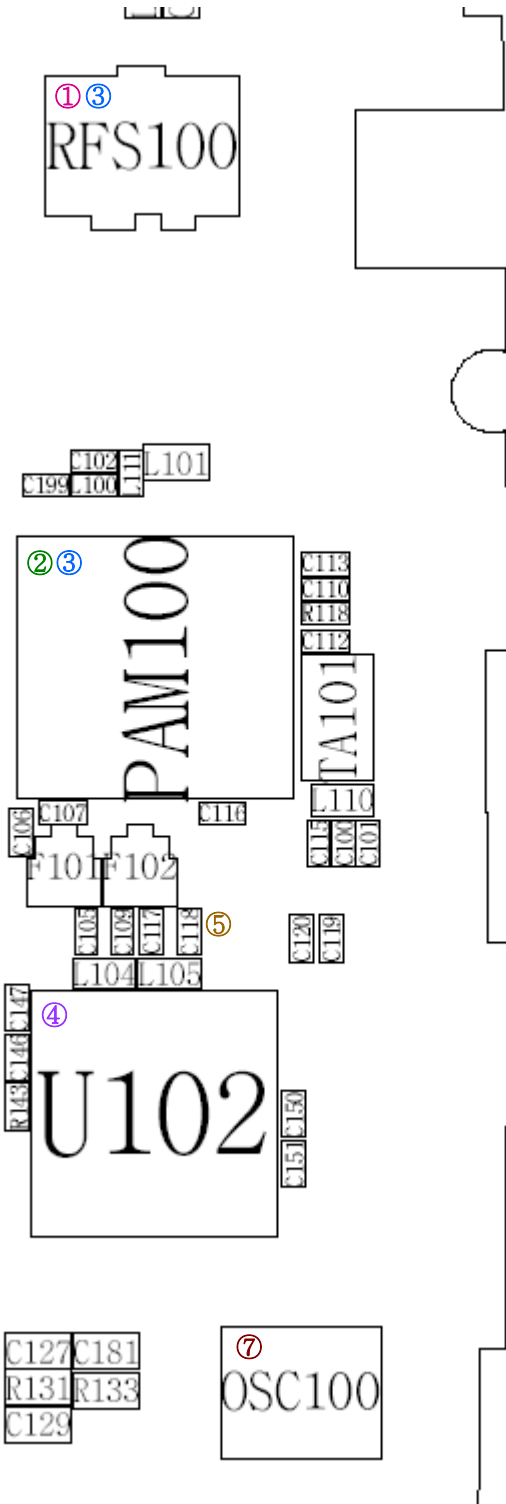

### 10-2-3. EGSM TX

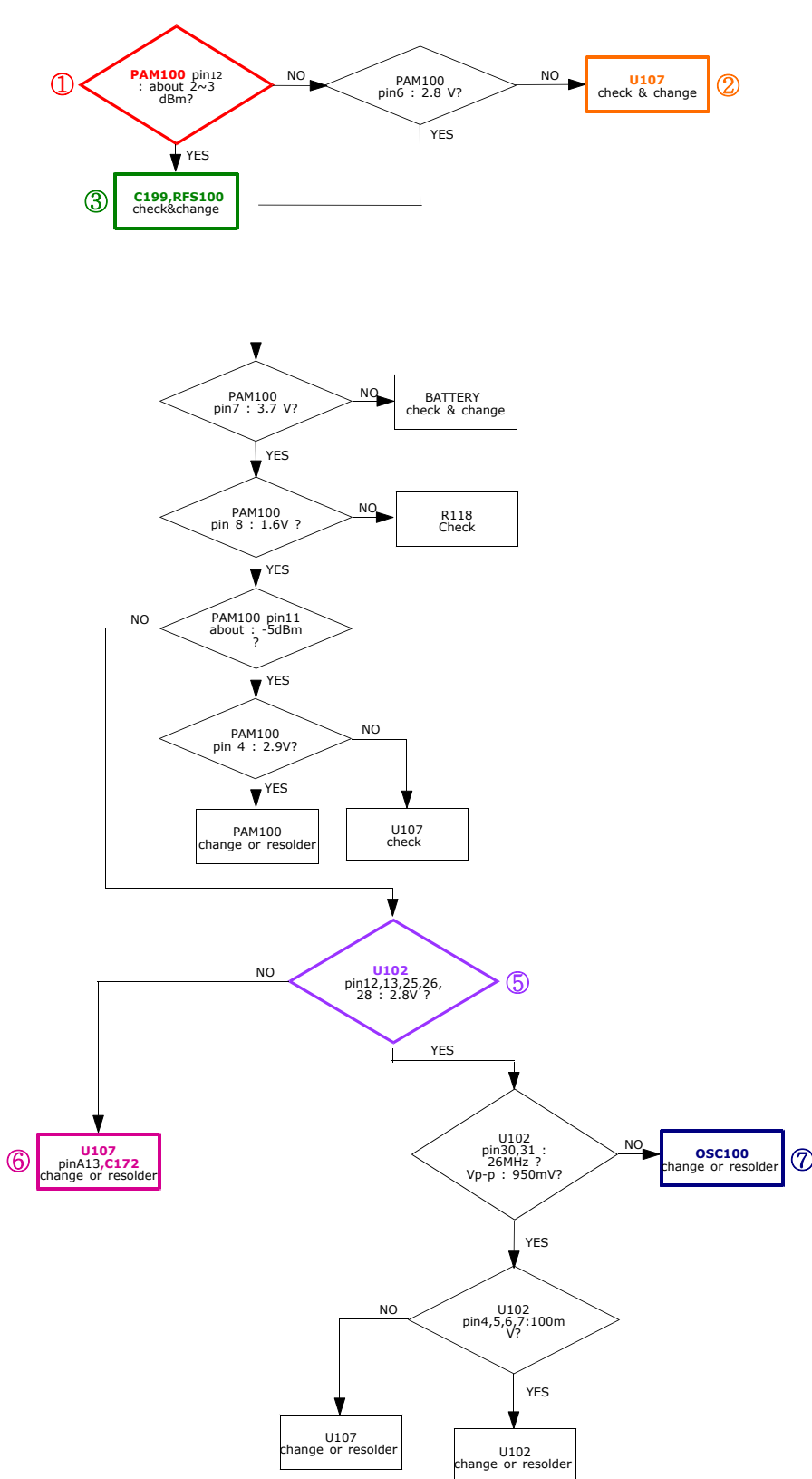

CONTINUOUS TX ON CONDITION  
 TX POWER DAC: 600\_CODE APPLIED  
 CH : 62  
 RBW : 100KHz  
 VBW : 100KHz  
 SPAN : 10MHz  
 REF LEV. : 10dBm  
 ATT. : 20dB

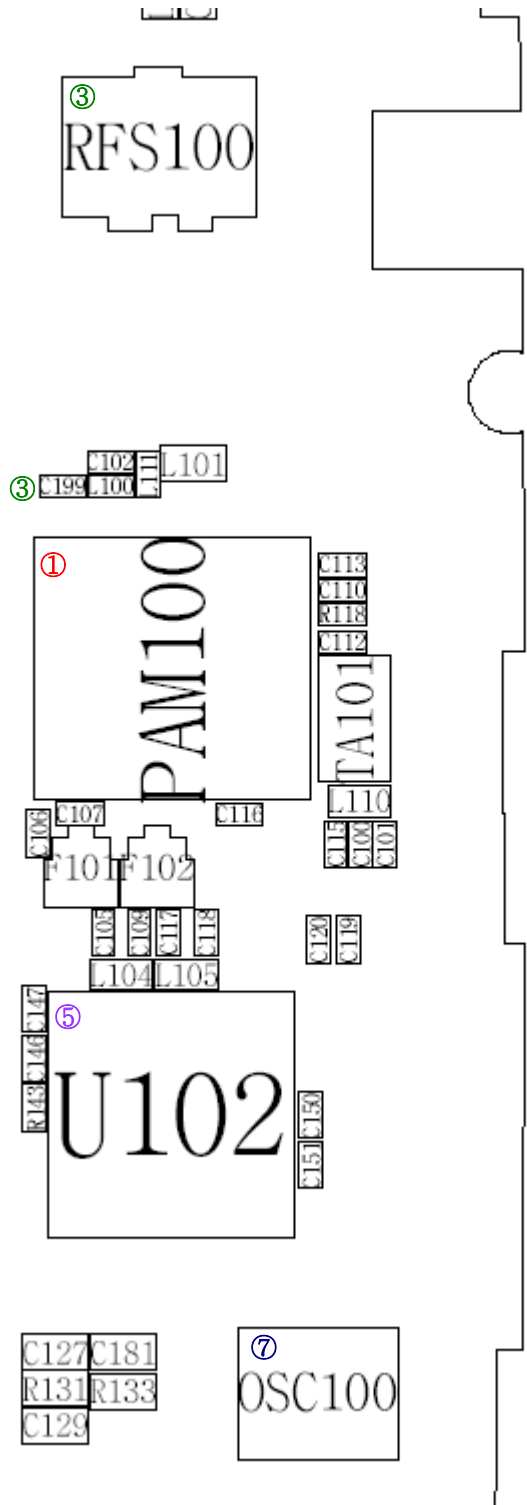

### 10-2-4. DCS TX

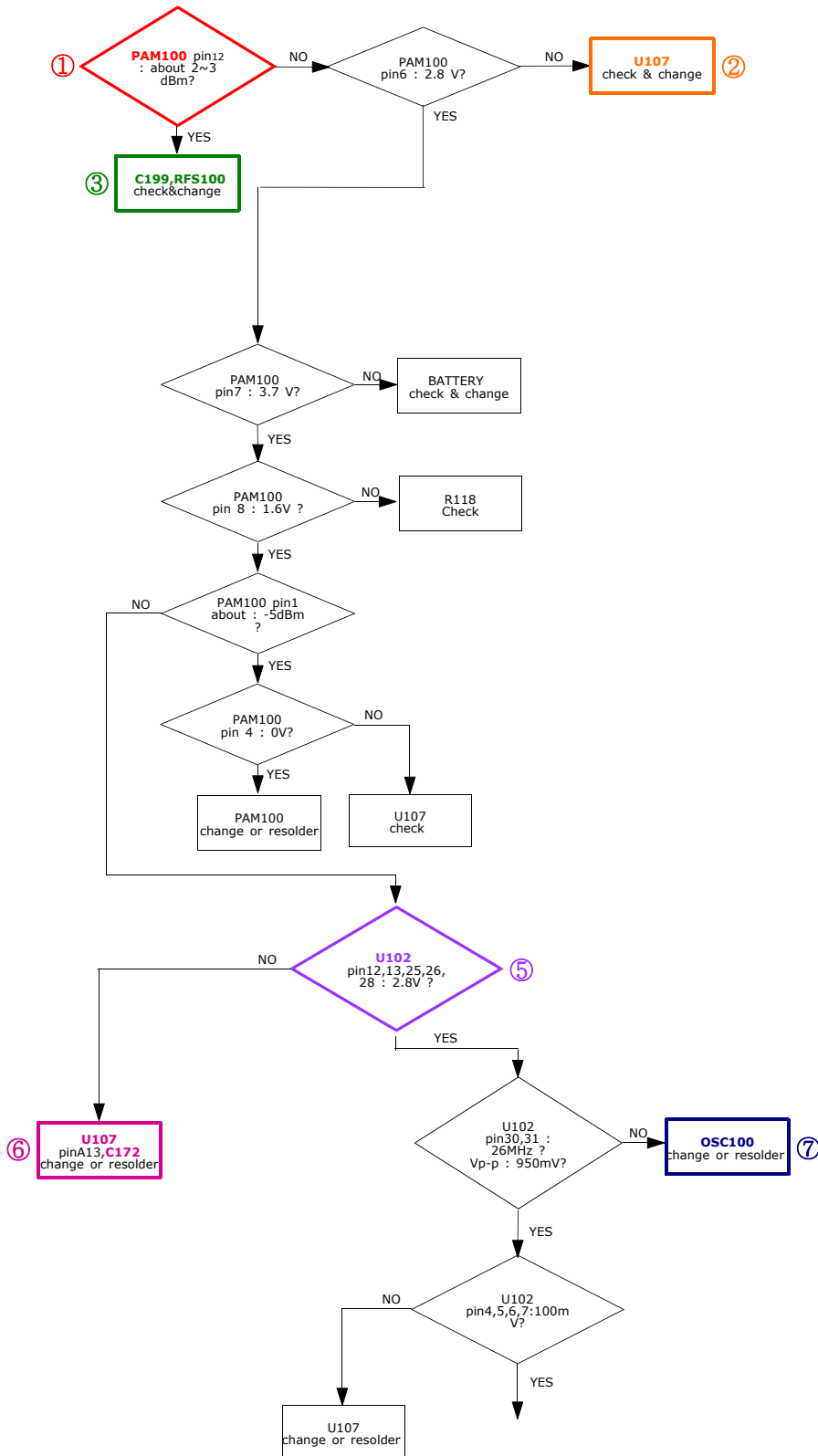

CONTINUOUS TX ON CONDITION  
 CH : 698CH(DCS)  
 TX POWER CODE: 520 CODE Applied  
 RBW : 100KHz  
 VBW : 100KHz  
 SPAN : 10MHz  
 REF LEV. : 10dBm  
 ATT. : 20dB



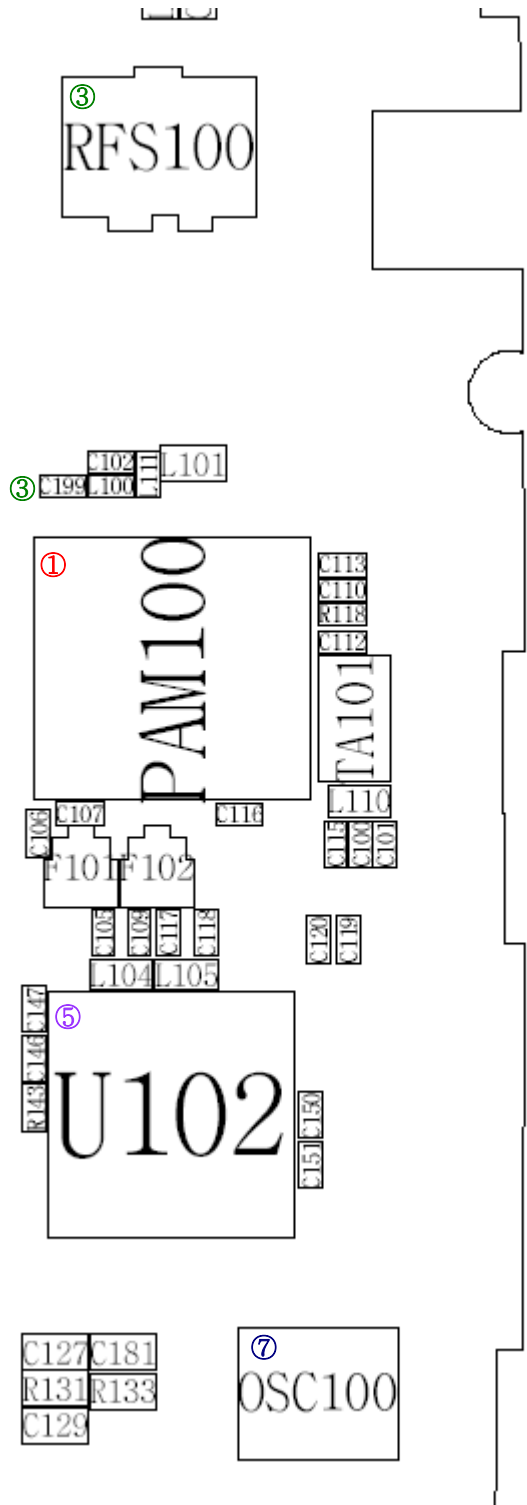

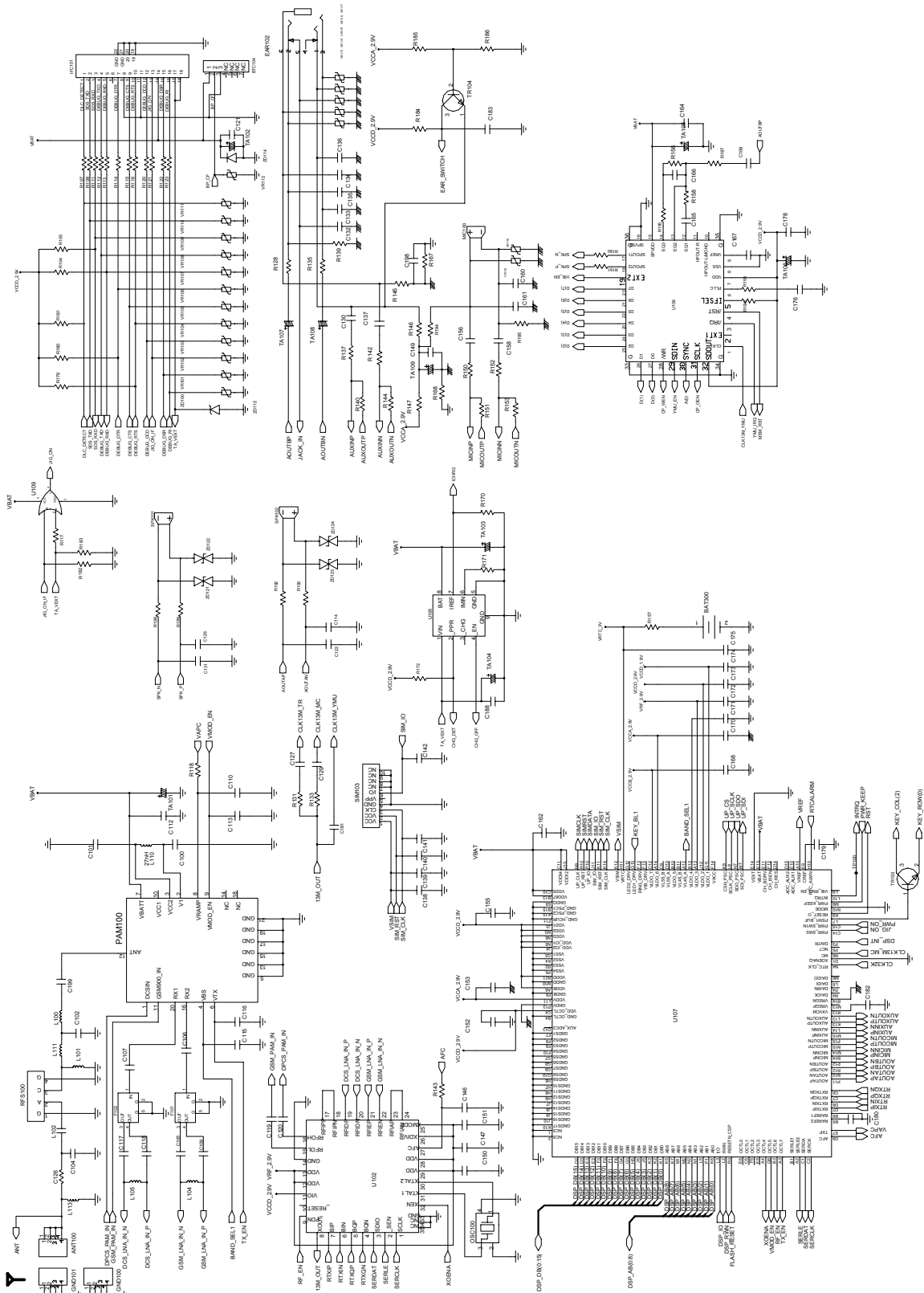

---

# 11. Reference data

---

## 11-1. Reference Abbreviate

**AAC**: Advanced Audio Coding.

**AVC** : Advanced Video Coding.

**BER** : Bit Error Rate

**BPSK**: Binary Phase Shift Keying

**CA** : Conditional Access

**CDM** : Code Division Multiplexing

**C/I** : Carrier to Interference

**DMB** : Digital Multimedia Broadcasting

**EN** : European Standard

**ES** : Elementary Stream

**ETSI**: European Telecommunications Standards Institute

**MPEG**: Moving Picture Experts Group

**PN** : Pseudo-random Noise

**PS** : Pilot Symbol

**QPSK**: Quadrature Phase Shift Keying

**RS** : Reed-Solomon

**SI** : Service Information

**TDM** : Time Division Multiplexing

**TS** : Transport Stream

**SAMSUNG  
ELECTRONICS**

