

# Service Schematics



## RH-99/100

## Introduction

### **Important:**

**This document is intended for use by authorized service centers only.**

“Service Schematics” was created with focus on customer care.  
The purpose of this document is to provide further technical repair information for NOKIA mobile phones on Level 3/4 service activities.  
It contains additional information such as e.g. “Component finder”.

Saving process time and improving the repair quality is the aim of this document.  
It is to be used additionally to the service manual and other training or service information such as Service Bulletins.

While every endeavour has been made to ensure the accuracy of this document, some errors may exist. If the reader finds any errors, NOKIA should be notified in writing.

Please send E-Mail to: [TrainingAndVendor.Development@nokia.com](mailto:TrainingAndVendor.Development@nokia.com)

Table of contents	
Frontpage	1
System connector & UI	2
UEM, UPP & Flash	3
RF part	4
Component finder	5

Copyright © NOKIA

This material, including documentation and any related computer programs is protected by copyright, controlled by NOKIA. All rights are reserved. Copying, including reproducing, modifying, storing, adapting or translating any or all of this material requires the prior written consent of NOKIA. This material also contains confidential information, which may not be disclosed to others without the prior written consent of NOKIA.

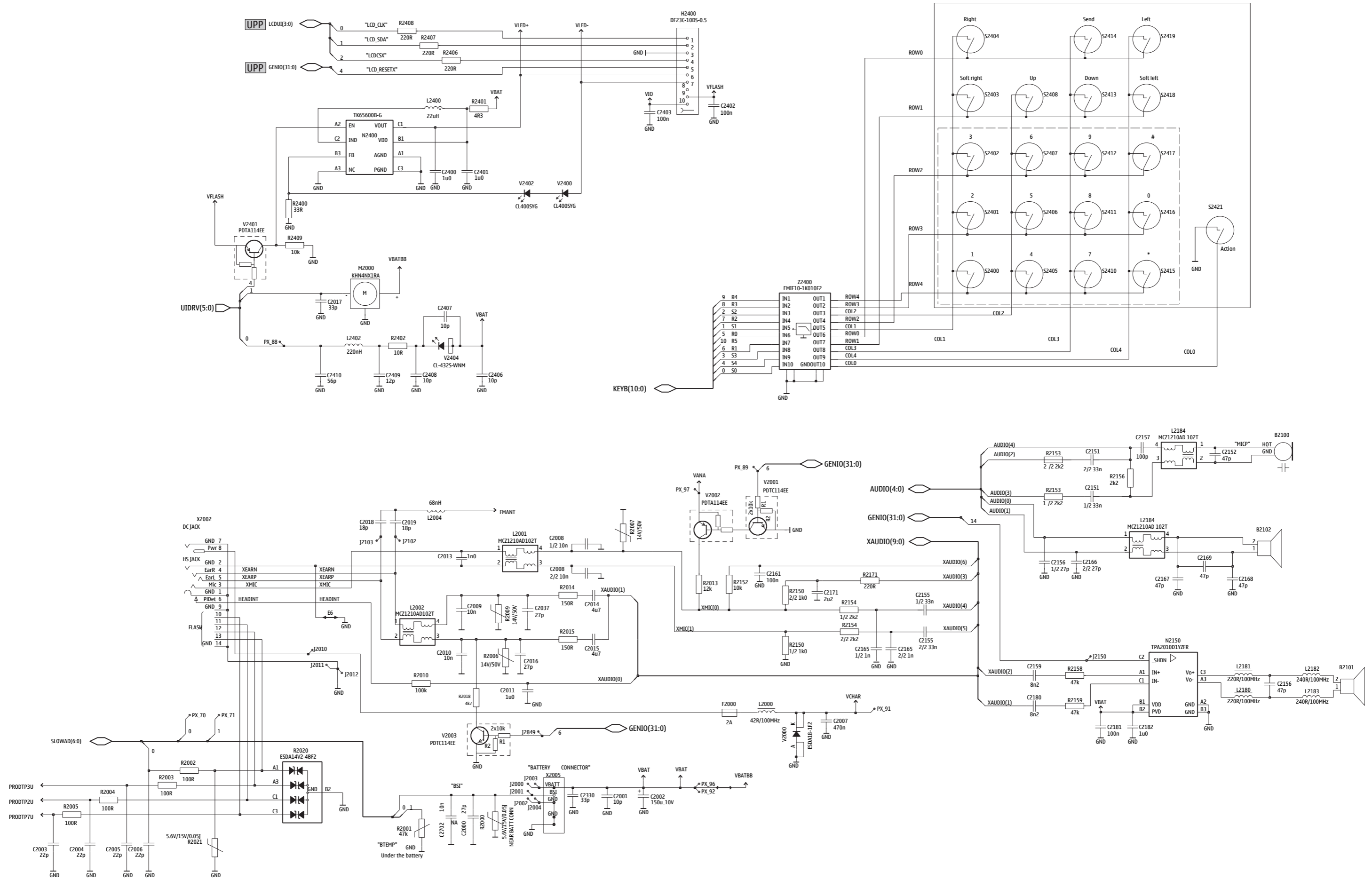



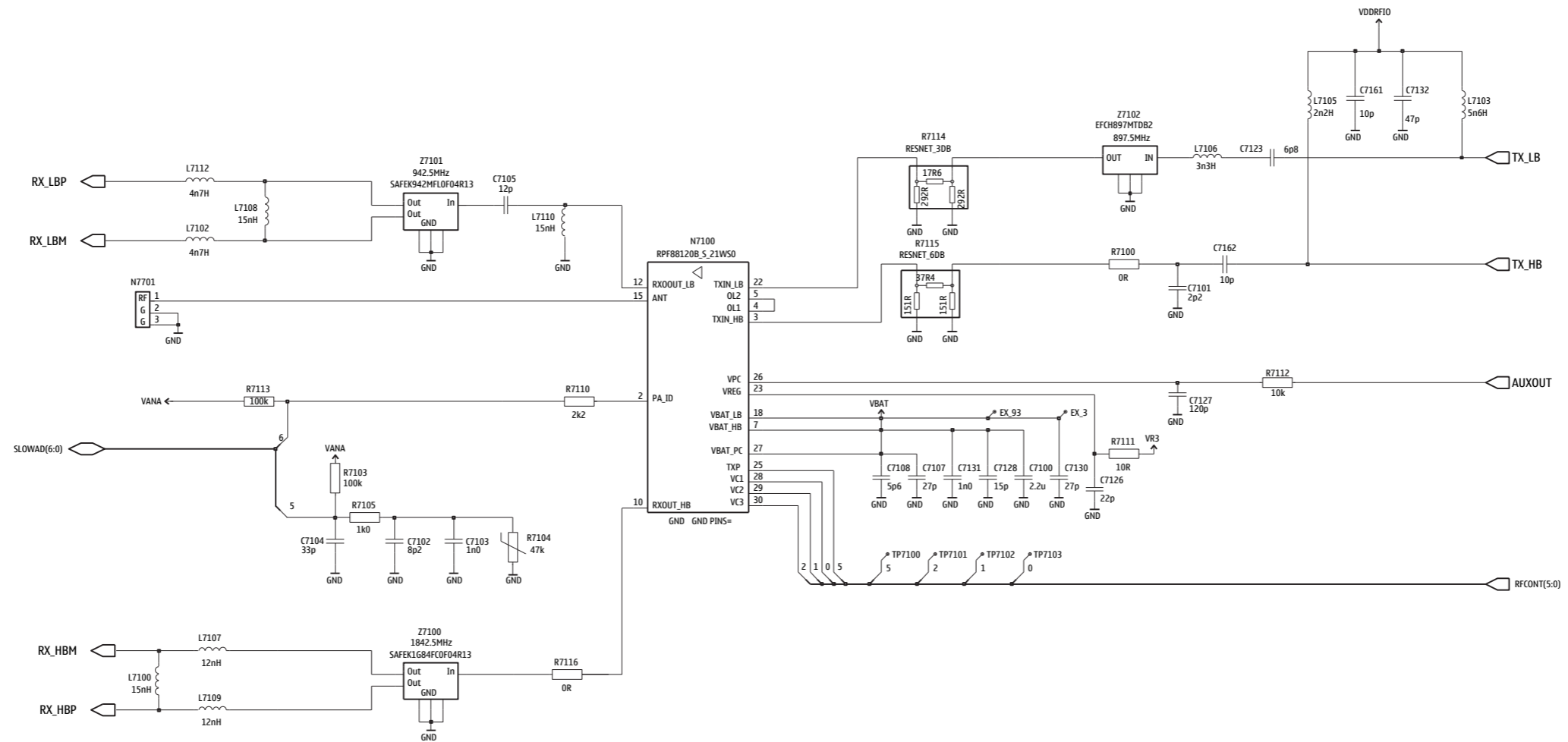

<b>B</b>	C2918	M4	L2183	F8	R7105	L3	
B2900	L4	C2919	L6	L2184	G7	R7110	L3
B7402	K6	C2920	L3	L2400	N3	R7111	J1
<b>C</b>	C2933	L3	L2402	O3	R7112	K1	
C2000	G3	C2937	M5	L7100	J5	R7113	L3
C2001	H2	C2940	L6	L7102	I5	R7114	J4
C2002	G4	C2941	M6	L7103	K5	R7115	J4
C2003	Q7	C2948	M5	L7105	J5	R7116	J4
C2004	R8	C2949	L6	L7106	K4	R7400	K5
C2005	Q7	C2950	K5	L7107	J5	R7401	I6
C2006	Q7	C2951	L3	L7108	I5	R7402	I5
C2007	S7	C7100	I3	L7109	J5	R7403	I5
C2008	R4	C7102	I1	L7110	I4	R7404	K6
C2009	O5	C7103	I1	L7112	J5	R7405	K6
C2010	O6	C7104	L3	<b>M</b>	R7407	M7	
C2011	S5	C7105	I4	M2000	G6	<b>V</b>	
C2013	R5	C7107	K2	N	V2000	S7	
C2014	N5	C7108	K2	N2150	O5	V2001	P4
C2015	N6	C7123	K4	N2400	O3	V2002	P4
C2016	O6	C7126	J1	N7100	J2	V2003	P3
C2017	G5	C7127	J1	<b>R</b>	V2400	S6	
C2018	P6	C7128	I3	R2000	G3	V2401	O4
C2019	P6	C7130	I1	R2001	Q3	V2402	S4
C2037	O6	C7131	I3	R2002	R7	V2404	B5
C2151	O4	C7132	K5	R2003	Q7	<b>X</b>	
C2152	S2	C7161	K5	R2004	R7	X2002	T5
C2154	N5	C7162	J5	R2005	Q7	X2005	G3
C2155	N5	C7400	K5	R2006	O6	X2700	Q4
C2156	F8	C7403	I5	R2007	R4	<b>Z</b>	
C2157	O4	C7404	J5	R2009	O5	Z2400	O7
C2159	O5	C7405	I5	R2010	S5	Z7100	J4
C2161	N5	C7406	K4	R2013	O5	Z7101	I4
C2165	N5	C7407	K6	R2014	O5	Z7102	K4
C2166	N6	C7408	K5	R2015	O6		
C2167	E8	C7436	K6	R2018	P5		
C2168	E8	C7442	J8	R2020	R7		
C2169	E8	C7444	I8	R2021	S5		
C2171	N5	C7445	K7	R2068	Q3		
C2180	O5	C7446	K8	R2069	Q3		
C2181	O5	C7447	J8	R2070	Q3		
C2182	O5	C7454	I6	R2150	N5		
C2330	H2	C7455	J8	R2152	N5		
C2400	O4	C7456	I7	R2153	N4		
C2401	N4	C7457	I6	R2154	O5		
C2402	N8	C7458	I5	R2156	O4		
C2403	N8	C7459	K5	R2158	O5		
C2406	B4	C7463	M7	R2159	O5		
C2407	B4	C7464	I8	R2171	N5		
C2408	B4	<b>D</b>	R2400	O3			
C2409	O3	D2901	L5	R2401	N4		
C2410	O3	D7400	L7	R2402	B4		
C2700	R3	D7402	J6	R2405	N6		
C2701	R4	<b>F</b>	R2406	N6			
C2901	M3	F2000	S7	R2407	N6		
C2902	M3	<b>H</b>	R2408	M6			
C2903	M6	H2400	N7	R2409	O4		
C2909	L3	<b>L</b>	R2700	P3			
C2910	L3	L2000	S7	R2900	M3		
C2911	K4	L2001	R5	R2901	L6		
C2912	K5	L2002	O6	R2902	M6		
C2913	M5	L2004	P6	R2908	L3		
C2914	M5	L2171	S2	R2909	M6		
C2915	M4	L2180	O5	R7100	J5		
C2916	K4	L2181	P5	R7103	L3		
C2917	M6	L2182	F8	R7104	J1		

