

Engineer		COMPANY NAME	
Drawn by		Address	
R&D CHK		City	
DOC CTRL CHK		TITLE:	Size
MFG ENDR CHK		AS	
<b>SGH-P510</b>			

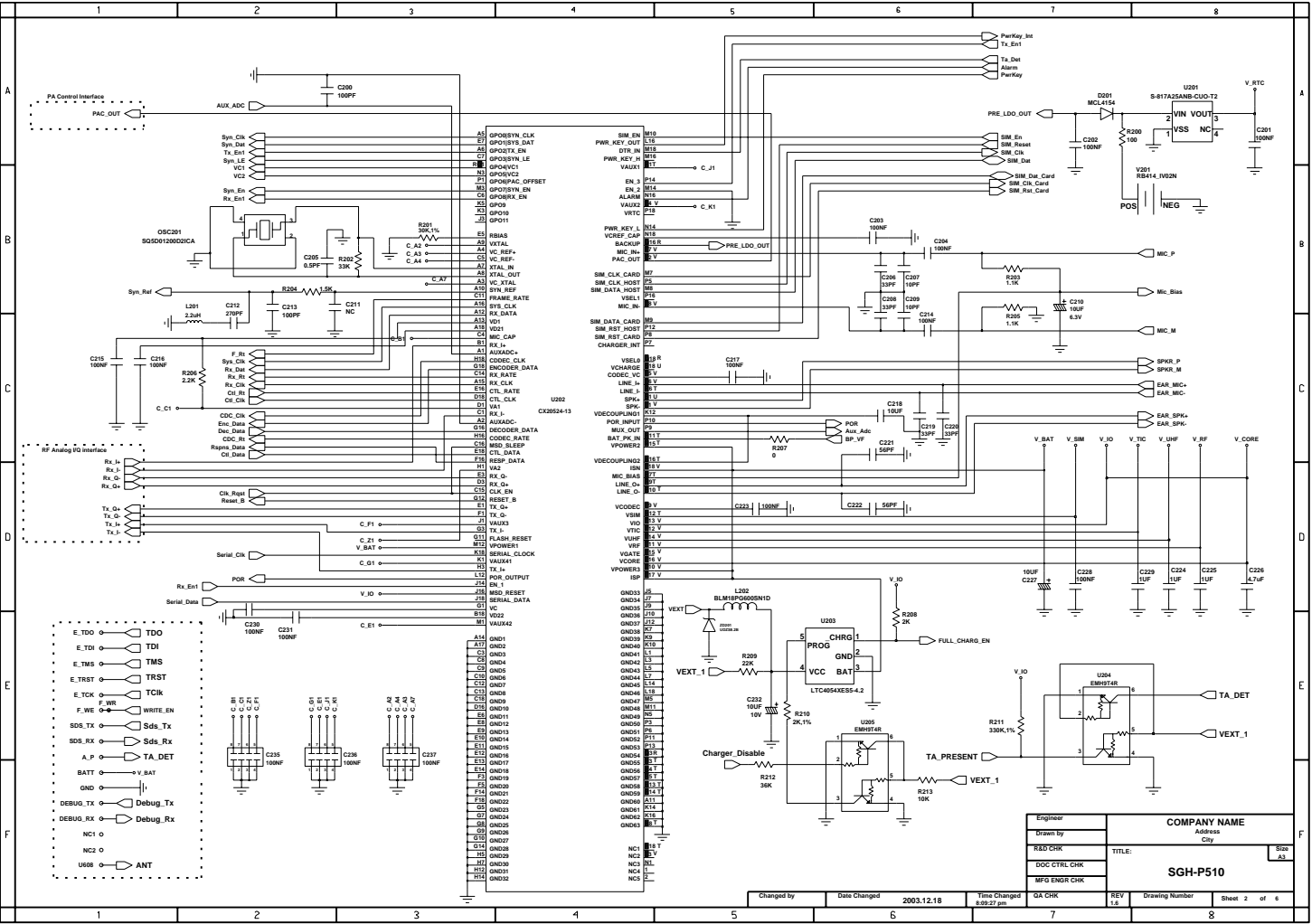

Engineer	COMPANY NAME	Size
Drawn by	Address	A3
READ CHK	City	
DOC CTRL CHK	TITLE:	
WFG ENDR CHK		
	<b>SGH-P510</b>	
Changed by	Date Changed	Time Changed
	2003.12.18	8:29:27 pm
CA CHK	REV	Drawing Number
	3.6	Sheet 2 of 6

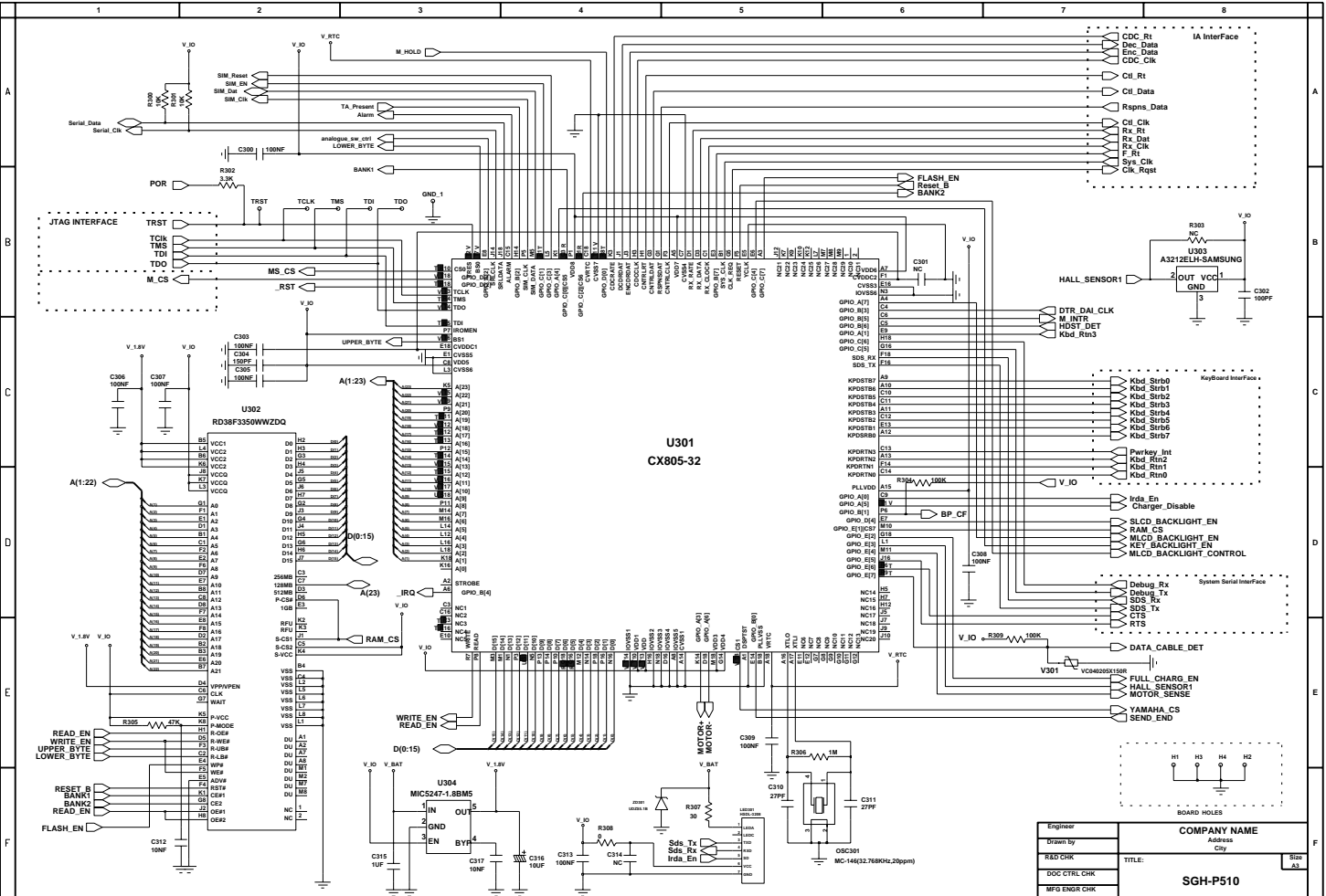

Engineer		COMPANY NAME	
Drawn by	Address		
READ CHK	City		
DOC CTRL CHK	TITLE:		
MFG ENDR CHK	SGH-P510		
Changed by	Date Changed	2003.12.18	Time Changed
		8:29:49 pm	
CA CHK	REV	1.5	Drawing Number
			Sheet 3 of 6

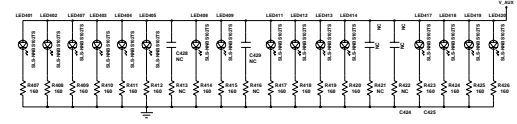
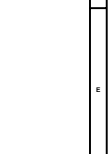
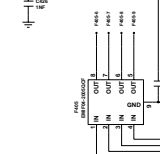
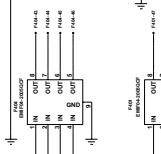
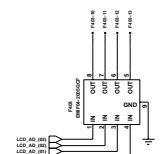
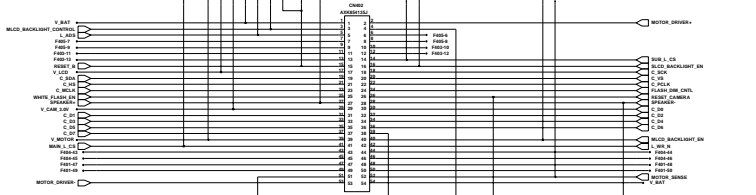
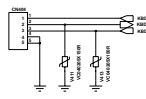
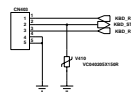
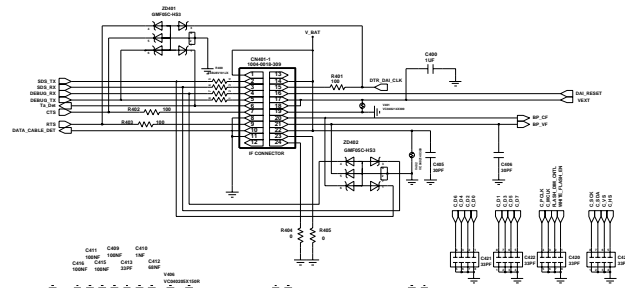
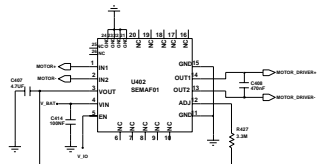
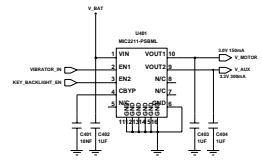
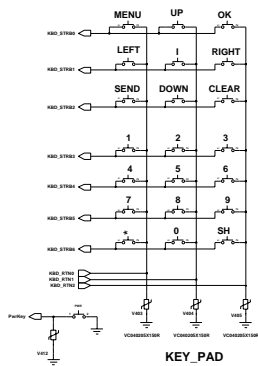

Engineer	COMPANY NAME	Size
Drawn by	Address	A5
Rev'd	City	
RFQ CHK	TITLE:	
DOC CTRL CHK		
INFO ENGR CHK		
	SGH-P510	

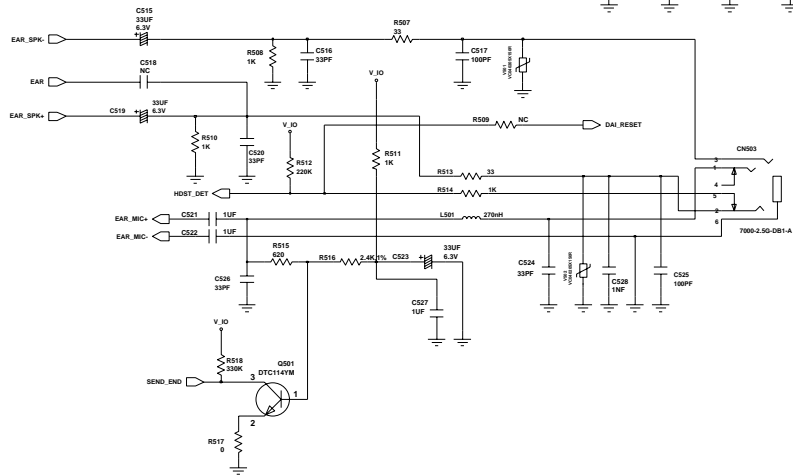
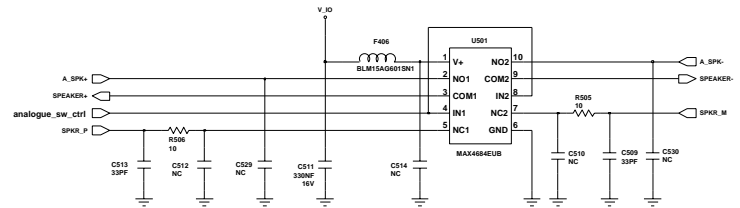
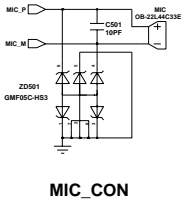
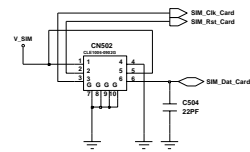
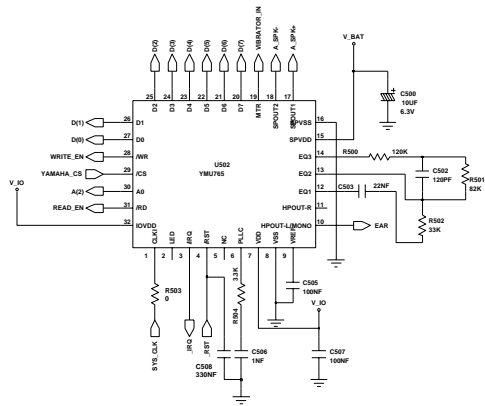

Engineer used		COMPANY NAME	
Desain by		Address	
REVISI		City	
DOC CTRL CHK		TITLE:	Size A3
MFG ENDR CHK		SGH-P510	
Chang by user			
Date Changed	2003.12.18	Time Changed	5:27:45 pm
GA CHK		Drawing Number	Sheet 5 of 6

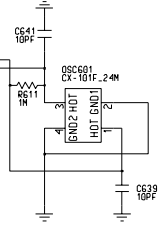
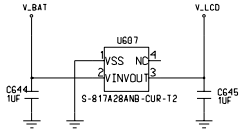
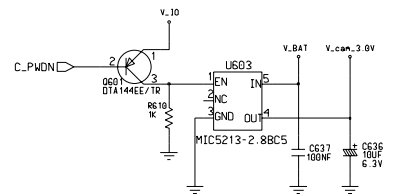
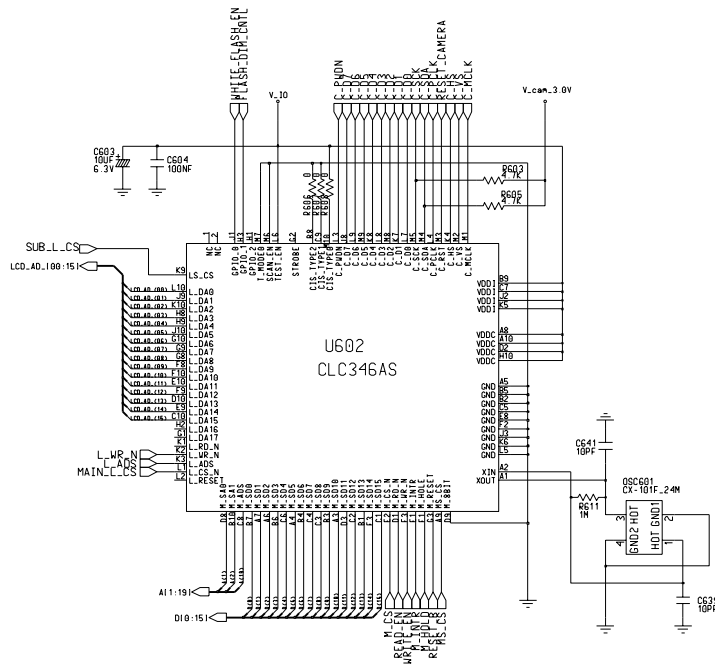

Engineer	COMPANY NAME		
Drawn by	Address		
Rev. CHK	City		
DOC. CTRL. CHK	TITLE:		Size A3
PRO. ENDR. CHK	SGH-P510		
Changed by User3	Date Changed 2003.12.18	File Changed 27.46.34.6A	DA CHK
			Rev. 1.0
	Drawing Number	Sheet 6 of 6	