

Nokia 3105 User Guide

9235338
Issue 2 EN

Copyright © 2005 Nokia. All rights reserved.

Reproduction, transfer, distribution or storage of part or all of the contents in this document in any form without the prior written permission of Nokia is prohibited.



The crossed-out wheeled bin means that within the European Union the product must be taken to separate collection at the product end-of life. This applies to your device but also to any enhancements marked with this symbol. Do not dispose of these products as unsorted municipal waste.

Nokia, Nokia Connecting People, Xpress-on and Pop-Port are trademarks or registered trademarks of Nokia Corporation. Other product and company names mentioned herein may be trademarks or tradenames of their respective owners.

Nokia tune is a sound mark of Nokia Corporation.

US Patent No 5818437 and other pending patents. T9 text input software Copyright © 1997-2005. Tegic Communications, Inc. All rights reserved.



Includes RSA BSAFE cryptographic or security protocol software from RSA Security.



Java is a trademark of Sun Microsystems, Inc.

Nokia operates a policy of continuous development. Nokia reserves the right to make changes and improvements to any of the products described in this document without prior notice.

Under no circumstances shall Nokia be responsible for any loss of data or income or any special, incidental, consequential or indirect damages howsoever caused.

The contents of this document are provided "as is". Except as required by applicable law, no warranties of any kind, either express or implied, including, but not limited to, the implied warranties of merchantability and fitness for a particular purpose, are made in relation to the accuracy, reliability or contents of this document. Nokia reserves the right to revise this document or withdraw it at any time without prior notice.

The availability of particular products may vary by region. Please check with the Nokia dealer nearest to you.

9235338 Issue 2 EN

Contents

For your safety	5	4. Using the menu.....	23
Overview of the functions.....	8	List of menu functions.....	23
1. Your phone.....	9	Messages (Menu 1).....	26
Keys and connectors.....	9	Call register (Menu 2)	34
Standby mode.....	9	Contacts (Menu 3)	36
Access codes	11	Profiles (Menu 4).....	41
2. Getting started	13	Settings (Menu 5).....	42
Installing the battery.....	13	Gallery (Menu 6).....	54
Charging the battery	13	Voice (Menu 7).....	54
Switching the phone on and off	14	Organiser (Menu 8).....	56
Normal operating position.....	14	Minibrowser(Menu 9).....	61
Keypad lock (Keyguard)	14	Games (Menu 10).....	66
Changing the front and back cover.....	15	Applications (Menu 11)	67
Charging the glow-in-the-dark cover.....	16	Go to (Menu 12)	69
3. Basic functions	17	5. PC Connectivity.....	70
Making a call	17	Nokia PC Suite.....	70
Answering or rejecting an incoming call	18	6. Battery information.....	72
Options during a call	18	Charging and discharging.....	72
Writing text.....	19	Battery performance	73

7. Mobile enhancements	75	Care and maintenance.....	79
A few practical rules for accessory operation.....	75	Important safety information.....	80
Chargers and other accessories.....	76	Index.....	86
Nokia Xpress-on™ colour covers.....	78		

For your safety

Read these simple guidelines. Breaking the rules may be dangerous or illegal. Further detailed information is given in this manual.



SWITCH ON SAFELY

Do not switch on the phone when wireless phone use is prohibited or when it may cause interference or danger.



ROAD SAFETY COMES FIRST

Do not use a hand-held phone while driving.



INTERFERENCE

All wireless phones may get interference, which could affect performance.



SWITCH OFF IN HOSPITALS

Follow any regulations or rules. Switch the phone off near medical equipment.



SWITCH OFF IN AIRCRAFT

Wireless devices can cause interference in aircraft.



SWITCH OFF WHEN REFUELLING

Do not use the phone at a refuelling point. Do not use near fuel or chemicals.



SWITCH OFF NEAR BLASTING

Do not use the phone where blasting is in progress. Observe restrictions, and follow any regulations or rules.



USE SENSIBLY

Use only in the normal position. Do not touch the antenna unnecessarily.



QUALIFIED SERVICE

Only qualified personnel may install or repair phone equipment.



ACCESSORIES AND BATTERIES

Use only approved accessories and batteries. Do not connect incompatible products.



WATER-RESISTANCE

Your phone is not water-resistant. Keep it dry.



BACKUP COPIES

Remember to make backup copies of all important data.



CONNECTING TO OTHER DEVICES

When connecting to any other device, read its user's guide for detailed safety instructions. Do not connect incompatible products.



EMERGENCY CALLS

Ensure the phone is switched on and in service. Press  as many times as needed to clear the display and return to the start screen.

Enter the emergency number, then press . Give your location. Do not end the call until told to do so.

■ About your device

The wireless phone described in this guide is approved for use on the CDMA network. Contact your service provider for information about the network.

When using the features in this device, obey all laws and respect privacy and legitimate rights of others.

■ Network Services

A number of features included in this guide are called Network Services. These are special services that you arrange through your wireless service provider. Before you can take advantage of any of these Network Services, you must subscribe to them through your service provider and obtain instructions for their use from your service provider.



Note: Some networks may not support all language-dependent characters and/or services.

■ Shared memory

Following phone features share memory: text and multimedia messages, images and ringing tones in gallery, bookmarks, and Java™ games and applications. Using any such features may reduce the memory available for any features sharing memory. This is especially true with heavy use of any of the features. For example, saving many images, Java applications, etc. may take all of the shared memory and your phone may display a message that the memory is full. In this case, delete some of the information or entries stored in the shared memory features before continuing.

■ About accessories

Check the model number of any charger before use with this device. This device is intended for use when supplied with power from ACP-7, ACP-12 and LCH-12.



Warning: Use only batteries, chargers and accessories approved by the phone manufacturer for use with this particular phone model. The use of any other types may invalidate any approval or warranty applying to the phone, and may be dangerous.

For availability of approved accessories, please check with your dealer.

When you disconnect the power cord of any accessory, grasp and pull the plug, not the cord.













Overview of the functions

The Nokia 3105 phone provides many functions which are practical for daily use, such as Calendar, Clock, Alarm clock, Profiles, and many more. Some functions are

- MMS - Multimedia Messaging Service, see [Multimedia messages](#) on page 29.
- Polyphonic MIDI ringing tones enable richer ringing tones with a wide variety of sounds.
- CDMA - Code Division Multiple Access is used for sending and receiving data over the mobile network.
- MIDP Java™ applications specially designed for mobile phones. See [Applications \(Menu 11\)](#) on page 67.
- Nokia OTA settings service. Several services need proper settings in your phone. You may receive the settings directly as an OTA (Over the Air) message, and you only need to save the settings. Contact your nearest authorised Nokia dealer for more information.

1. Your phone

■ Keys and connectors

1. Power key 
2. Selection keys  and 
3. 4-way scroll key with , ,  and 
4.  dials a phone number, and answers a call. In standby mode it shows the most recently called number.
5.  ends an active call.
Exits from any function.
6.  -  enter numbers and characters.
***+ and ** are used for various purposes in different functions.
7. Charger connector
8. Pop-Port™ connector for headset and data cable, for example

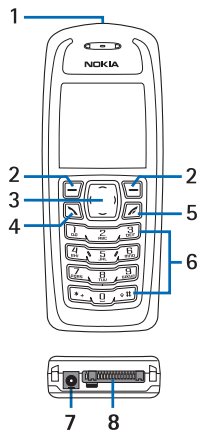

■ Standby mode

When the phone is ready for use, and you have not keyed in any characters, the phone is in standby mode.

1. Shows the name of the network or the operator logo.
2. Shows the signal strength of the cellular network at your current location.
3. Shows the battery charge level.
4. The left selection key in standby mode is **Menu**.
5. The right selection key in standby mode is **Contacts** or **Go to** (personal short-cut). To set the functions for your Personal short-cut, see [Personal short-cuts](#) on page 42.

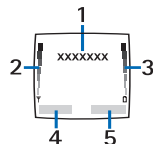







Power saving

For power saving a digital clock view overwrites the display when no function of the phone has been used for a certain period of time.



Essential indicators

-  You have received one or several text or picture messages. See [Reading and replying to a message or a SMS e-mail](#) on page 27.
-  You have received one or several minibrowser messages. See [Minibrowser messages](#) on page 65.
-  You have received one or several multimedia messages. See [Reading and replying to a multimedia message](#) on page 31.
-  The phone's keypad is locked. See [Keypad lock \(Keyguard\)](#) on page 14.

-  The phone does not ring at an incoming call or text message when *Incoming call alert* is set to *Off* and *Message alert tone* is set to *Off*. See [Tone settings](#) on page 48.
-  The alarm clock is set to *On*. See [Alarm clock](#) on page 56.
-  The loudspeaker has been activated. See [Loudspeaker](#) on page 19.

■ Access codes

Security code (5 to 10 digits)

The security code protects your phone against unauthorised use. The preset code is 12345. Change the code, and keep the new code secret and in a safe place separate from your phone. To change the code, see [Security settings](#) on page 49.

PIN code (4 to 8 digits)

The PIN (Personal Identification Number) code protects your SIM card against unauthorised use. The PIN code is usually supplied with the SIM card.

After three consecutive incorrect PIN code entries, the PIN code is blocked. If the PIN code is blocked, you need to unblock the PIN code before you can use the SIM card again.

PIN2 code (4 to 8 digits)

The PIN2 code may be supplied with the SIM card and is required to access some functions such call counters.

PUK and PUK2 codes (8 digits)

The PUK (Personal Unblocking Key) code is required to change a blocked PIN code. The PUK2 code is required to change a blocked PIN2 code. If the codes are not supplied with the SIM card, contact your local service provider for the codes.

2. Getting started

■ Installing the battery



Warning: Use only the BLC-5C battery in this Nokia phone. If your dealer has already installed the battery, please see [Charging the battery](#).

1. Remove the back cover from the phone. With the back of the phone facing you, push the back cover release button.
2. Slide the back cover off.
3. Insert the battery.
4. Slide the back cover into its place.

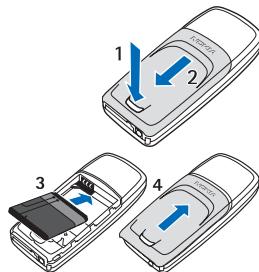

■ Charging the battery

1. Connect the lead from the charger to the socket on the bottom of your phone.
2. Connect the charger to an AC wall socket.

The text *Charging* is displayed briefly if the phone is switched on. If the battery is completely empty, it may take a few minutes before the charging indicator appears on the display or any calls can be made.

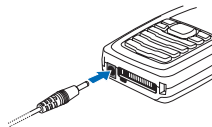

The charging time depends on the charger and the battery used. For example, charging a BL-5C battery with the ACP-7 charger takes up to 3 hours in standby mode.

■ Switching the phone on and off



Warning: Do not switch the phone on when wireless phone use is prohibited or when it may cause interference or danger.

Press and hold the power key .



■ Normal operating position

Use the phone only in its normal operating position.

Your phone has a built-in antenna. As with any other radio transmitting device, do not touch the antenna unnecessarily when the phone is switched on. Contact with the antenna affects call quality and may cause the phone to operate at a higher power level than otherwise needed.

Not touching the antenna area during a phone call optimises the antenna performance and the talktime of your phone.



■ Keypad lock (Keyguard)

You can lock the keypad to prevent the keys being accidentally pressed.

Press **⏏** (**Menu** or **Unlock**) and then ***+** within 1.5 seconds to lock or unlock the keypad.

An incoming call can be handled normally. When you end or reject the call, the keypad will automatically be locked again.

For automatic keypad lock, see [Automatic keyguard](#) on page 45.



Note: When the keypad is locked, calls may be possible to the emergency number programmed into your phone (e.g. 112, 911 or other official emergency number). Key in the emergency number and press **⏏**. The number is displayed only after you have keyed in its last digit.

■ Changing the front and back cover

Before changing the covers, always switch off the power and disconnect the phone from the charger or any other device. Always store and use the phone with the covers attached.

1. Remove the back cover of the phone. With the back of the phone facing you, push the back cover release button (1) and slide the back cover off (2).

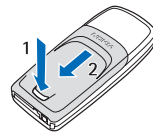

2. To remove the front cover, gently pull the back part of the phone away from the front cover beginning at the bottom of the phone.

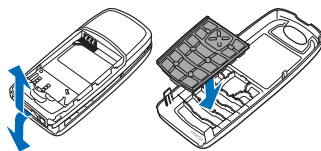

3. Insert the key mat on the new front cover.
4. To attach the front cover, first place the phone and the front cover properly together and then gently push on the top and bottom of the phone until the catch is locked properly.

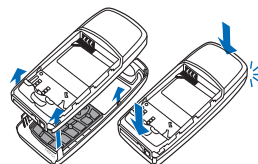

5. Place the back cover and the phone properly together (1) and slide the back cover into its place (2) until the back cover release button is properly locked.





■ Charging the glow-in-the-dark cover



The front cover of your Nokia 3105 phone has a glow-in-the-dark element. To make the cover glow you need to expose it to a bright light source for at least 12 minutes, for full charge 18 minutes.

3. Basic functions



■ Making a call

1. Key in the phone number, including the area code. If you key in a wrong character, press **Clear** to delete it.
2. Press  to call the number.
3. Press  to end the call or to cancel the call attempt.

Making a call using the contacts list

In standby mode, press  or  to find the name or key in the first character(s) of the name you are looking for. See also [Searching for a name in contacts](#) on page 37. Press  to call the number on the display.

Last number redialling

In standby mode, press  once to access the list of up to 20 numbers you last called or attempted to call. Scroll to the number or name you want, and press  to call the number.



Speed dialling a phone number

Assign a phone number to one of the speed dialling keys, from **2^{ABC}** to **9^{WXYZ}**, see menu option *Speed dials* in chapter [Contacts \(Menu 3\)](#) on page 36. Call the number in either of the following ways:

- Press the speed dialling key you want and then press .

- If *Speed dialling* is set to on, press and hold a speed dialling key until the call is started. See [Speed dialling](#) on page 43.

■ Answering or rejecting an incoming call

Press  to answer the incoming call and press  to end the call.

Press  to reject the incoming call.

Press **Silence**, if available, to mute the ringing tone. Then either answer or reject the call.



Tip: If the *Divert if busy* function is activated to divert the calls, for example to your voice mailbox, rejecting an incoming call will also divert the call. See [Call divert](#) on page 52.

Call waiting

During a call, press  to answer the waiting call. The first call is put on hold.

Press  to end the active call.

To activate the *Call waiting* function, see [Call waiting](#) on page 52.

■ Options during a call

Many of the options that you can use during a call are network services. Press **Options** during a call for some of the following options:

End call, Mute or Unmute, Loudspeaker or Handset, New call, Save, Add to contact, End all calls, Send DTMF, Contacts, Menu,

Loudspeaker

You can use your phone as a loudspeaker during a call.





Warning: Do not hold the phone near to your ear when the loudspeaker is in use, because the volume may be extremely loud.

To activate the loudspeaker, press **Options** and select *Loudspeaker*, or press **Loudsp.**, if available.

To deactivate the loudspeaker during a call, press **Options** and select *Handset*, or press **Handset**, if available.

■ Writing text

You can key in text in two different ways, using the traditional text input, indicated with , or using the predictive text input indicated with  at the top left of the display. The character case is indicated by **Abc**, **abc**, or **ABC** next to the text input indicator. You can change the character case by pressing **⇄##**. The number mode is indicated by **123**, and you can change between the letter and number mode by pressing and holding **⇄##**.

Setting predictive text input on or off

When writing text, press **Options** and select *Dictionary*.

- To set the predictive text input on, select a language in the dictionary options list.
- To change back to the traditional text input, select *Dictionary off*.



Tip: To quickly set the predictive text input on or off when writing text, press **☞#** twice, or press and hold **Options**.

Using predictive text input

Predictive text input is an easy way to write text.

The predictive text input is based on a built-in dictionary to which you can also add new words.

1. Key in the word you want by pressing each key once for one letter. The word changes after each keystroke. For example, to write 'Nokia' when the English dictionary is selected, press **6**^{mno}, **6**^{mno}, **5**^{jkl}, **4**^{ghi}, **2**^{abc}.
 - To delete the character to the left of the cursor, press **Clear**. Press and hold **Clear** to delete the characters more quickly.
 - To switch between upper and lower cases, or between traditional and predictive text input, press **☞#** repeatedly and check the indicator at the top of the display.
 - To insert a number, press and hold the desired key. To switch between letters and numbers, press and hold **☞#**.
 - To insert a period ".", press **1**^{.,}.
 - To get a list of special characters, press and hold ***+**, select the character you want, or press ***+** again to select a smiley from the offered list. Press **Use** to insert a special character or a smiley.
2. If the displayed word is the one you want, press **□** **_** and start writing the next word.

- If you want to change the word, press *+ repeatedly to the word you want.
- If the "?" is displayed after the word, the word is not in the dictionary. To add the word to the dictionary, press **Spell**, key in the word (traditional text input is used) and press **OK**.

Writing compound words



Key in the first half of the word, press >, and then key in the second half.

Using traditional text input

Press the key marked with the letter that you want repeatedly until the letter appears.



Use the following functions to edit the text:

- To add a space, press **□ _**.
- To add a punctuation mark or special character, press **100** repeatedly, or press *+, select the desired character, and press **Use**.
- To move the cursor to the left, right, down or up, press the scroll keys **(,)**, **∨** or **∧**, respectively.
- To delete a character to the left of the cursor, press **Clear**. Press and hold **Clear** to delete the characters more quickly.
- To switch between upper and lower case, press **◇#**.
- To add a number, press and hold the desired key. To switch between letters and numbers, press and hold **◇#**.

- To key in a letter which is on the same key as the previous one, wait until the cursor appears or, press  or  and key in the new letter.
- To add a smiley, press *+ twice and select the desired smiley, and press **Use**.

4. Using the menu

The phone offers you an extensive range of functions which are grouped in menus.

To access the menu, press **Menu**. Scroll with  or  through the menus

and select the menu by pressing **Select**. Select submenus and settings of your choice in the same way.

Press **Back** to return to the previous menu level, and **Exit** to exit the menu.

■ List of menu functions

1. Messages



1. Text messages
2. Multimedia msgs.
3. Voice messages
4. Minibrowser messages

2. Call register



1. Missed calls
2. Received calls
3. Dialed numbers
4. Delete recent call lists
5. Call duration
6. Data/fax calls
7. Minibrowser calls

3. Contacts



1. Search
2. Add new
3. Edit name
4. Delete
5. Add number
6. Settings
7. Speed dials
8. Voice tags
9. My number
10. Caller groups

4. Profiles

1. General
2. Silent
3. Meeting
4. Outdoor
5. Pager



5. Settings

1. Right selection key settings
2. Call settings
3. Phone settings
4. Time and date settings
5. Display settings
6. Tone settings
7. Enhancement settings¹
8. Security settings
9. Network
10. Network services
11. Restore factory settings



6. Gallery

1. View folders
2. Add folder
3. Delete folder
4. Rename folder



7. Voice

1. Voice tags
2. Voice commands
3. Voice Recorder



8. Organiser

1. Alarm clock
2. Calendar
3. To-do list
4. Calculator
5. Countdown timer
6. Stopwatch
7. Calorie counter



9. Minibrowser



1. This menu is shown only if the phone is or has been connected to a compatible headset, handsfree unit or loopset available for the phone.

10. Games

1. Select game
2. Memory
3. Settings



11. Applications

1. Select application
2. Browser downloads
3. Memory



12. Go to



■ Messages (Menu 1)

You can read, write, send and save text, multimedia, and e-mail messages.



Text messages

You can send and receive text messages that contain pictures.



Note: Picture message function can be used only if it is supported by your network operator or service provider. Only phones that offer picture message features can receive and display picture messages.

To check e-mail service availability and to subscribe to the service, contact your service provider. To save an e-mail address in the contacts list, see [Saving multiple numbers, text items and an image per contact](#) on page 38.

Writing and sending SMS or e-mail messages

The number of available characters for the message are shown on the top right of the display, starting with maximum and decreasing.

1. Press **Menu**, and select *Messages, Text messages, Create message*, or press **(** (short-cut).
2. If supported by your phone select *Text* to create a text message or select *Numeric page* to send a phone number for example to a pager.
3. You can specify several e-mail or SMS recipients for a text message:
Select *Add e-mail* and key in an e-mail address.
Select *Add number* and key in a phone number.
Select *Add list* to add a predefined distribution list.

You can also *Search* e-mail addresses or numbers in *Contacts* and create and send messages to the selected number.

4. Select *Edit message* and key in a text message or for a *Numeric page* select *Callback number* to enter a phone number. See *Writing text* on page 19. Following options may be available: *Preview* (if a picture is inserted), *Send*, *List recipients*, *Settings*, *Save message*, *Clear text*, *Exit editor*, *Insert contact*, *Insert number*, *Use template*, *Insert picture*, *Change picture*, *Delete picture*, *Insert smiley*, *Edit word*, *Insert word*, *Insert symbol*, *Dictionary* and *Matches* if predictive text is activated.
5. To send the message, press *Options* and select *Send*.

Reading and replying to a message or a SMS e-mail

When you have received a message or an e-mail, the indicator  and the number of new messages followed by *messages received* is shown.

Received messages are automatically stored in the memory.

1. Press *Show* to view the message, or press *Exit* to view it later.

If more than one message is received, select the message you want to read. An unread text message is indicated by  in front of it.

2. While reading or viewing the message, press *Options*.

You can select, for example, an option to delete, divert or edit the message as a text message or an e-mail, move and rename the message you are reading.

Select *Message details* to view the sender's name and phone number, the message centre used, reception date and time. Select *Use number* to extract numbers, *Save address* (network service) to extract e-mail addresses and *Use*

- web link*¹ to extract URL's from the current message. When reading a picture message, select *Save picture* to save the picture in the *Templates* folder.
3. Select *Reply* to reply to a message. Select *Empty screen*, *Original text* or select a standard answer to be included in the reply. Write your reply message.
Press **Options**, select *Send*, and press **OK** to send the message.

Inbox and Sent Items folders

The phone saves the incoming text messages in the *Inbox* folder and the sent messages in the *Sent Items* folder of the *Text messages* submenu.

The text messages you want to send later, can be saved in the *Archive*, *Sent Items*, *Templates* folder or in folders, which were added by yourself (see next section).



Archive folder and my folders

You can organise your messages in the *Archive* folder or in new added folders.

While reading a message, press **Options**. Select *Save message*, scroll to the folder where you want to save the message and press **OK**.

To add or delete a folder, press **Menu**, and select *Messages*, *Text messages* and *My folders*. Press **Options** and select *Add folder* or *Delete folder*.

Templates

Your phone offers you text templates , and picture templates .

To access the template list, press **Menu**, and select *Messages*, *Text messages* and *Templates*.

Distribution lists

If you often need to send messages to a fixed group of recipients, you can define distribution lists in the phone's directory.

To edit the distribution lists, press **Menu**, and select *Messages*, *Text messages* and *Distribution lists*. Press **Options** and select *Add list*, *Rename list*, *Clear list* or *Delete list*.

To view the names in the selected distribution list, press **Menu**, and select *Messages*, *Text messages* and *Distribution lists*. Press **Options** and select *View list*. Press **Options** again to edit the content of a distribution list: *Add contact*, *View details* or *Delete contact*.

Multimedia messages



Note: This function can be used only if it is supported by your network operator or service provider. Only phones that offer multimedia message features can receive and display multimedia messages.

A multimedia message can contain text, picture and sound. The phone supports multimedia messages of size up to 30 kB.



Note: If *Allow multimedia reception* is set to *Yes* or *In home network*, your operator or service provider may charge you for every message you receive. For details see [Settings for multimedia messages](#) on page .33.

Multimedia messaging supports the following formats:

- Picture: JPEG, GIF, PNG, OTA-BMP and WBMP.
- MIDI





Note: If a received message contains unsupported elements, they may be replaced with the text *Object format not supported*.

You are not able to receive any multimedia messages, if you have a call in progress, a game or another Java application running, or an active service connection. Because delivery of multimedia messages can fail for a variety of reasons, do not rely solely upon them for essential communications.

Writing and sending a multimedia message

To set the settings needed, see [Settings for multimedia messages](#) on page 33. For availability and subscription to the multimedia messaging service, contact your service provider.

1. Press **Menu**, and select *Messages, Multimedia msgs.* and *Create message*.
2. Key in a message.

To insert a picture or a sound clip from *Gallery*, press **Options**, and select *Insert image* or *Insert sound clip*. The list of available folders in the *Gallery* is shown. Open a specific folder, scroll to the desired picture or sound, press **Options** and select *Insert*. The  or  indicator on the header of the message indicate that a picture or sound has been attached.

To key in a name from the contacts list, press **Options** and select *More options* and *Insert contact*.

To insert a number, press **Options** and select *More options* and *Insert number*.

To view the message before sending it, press **Options** and select *Preview*.



3. To send the message, press **Options** and select *Send to number* (or *Send to e-mail* or *Send to many*).

4. Key in the recipient's phone number (or e-mail address) or search for the phone number (or e-mail address) in the contacts list and confirm the number.

During sending the animated indicator  is displayed and you can use the other functions of the phone. If the sending fails, the phone tries to resend it for a few times. After that the message remains in the *Outbox* folder and you can try to resend it.

Copyright protection may prevent some images, ringing tones and other content from being copied, modified, transferred or forwarded.

Reading and replying to a multimedia message

During receiving a multimedia message, the animated indicator  is displayed. A received message is indicated with  and the text *Multimedia message received* is shown.

1. Press **Show** to view the message, or press **Exit** to view it later.
2. Once you press **Show**, press **Options** and some of the following options may be available: *Delete message, Reply, Reply to all, Forward to no., Forward to e-mail, Forward to many, Message details, Play, Save sound clip, Save image, Zoom* and *Details*.

Multimedia messages Inbox, Outbox and Saved items folders

The phone saves the received multimedia messages in the *Inbox* folder. Multimedia messages to be sent are moved to the *Outbox* folder. The multimedia messages you want to send later, can be saved in the *Saved items* folder. The sent multimedia messages are saved in the *Sent items* folder if the setting *Save sent messages* is set to *Yes*. See [Settings for multimedia messages](#) on page 33.

Multimedia messages memory full

Received messages are automatically stored in the memory.

When you have a multimedia message waiting and the memory for the messages is full, the indicator  is blinking and *Multimedia memory full, view waiting msg.* is shown. To view the waiting message, press **Show**. To save the message, press **Options**, select *Save message*. You will be asked to delete old messages by first selecting the folder and then an old message to be deleted. To discard the waiting message, press **Exit** and **Yes**. To view the message, press **No**.

Deleting messages

Press **Menu**, and select *Messages, Text messages* or *Multimedia msgs.* and *Delete messages*.

- To delete all messages from one folder, select the folder.

If the folders contain unread messages, the phone will ask whether you want to delete them also.

Message settings

The message settings affect the sending, receiving or viewing of the messages.

Settings for text and SMS e-mail messages

Press **Menu**, and select *Messages, Text messages, Message settings* and *Sending profile*:

- Select *Priority* to mark your message as *Urgent*.

- Select *Delivery reports* and *On*, to be notified when the recipient receives the message.
- Select *Send callback number* to enter a phone number at which the recipient can call you.

Press **Menu**, and select *Messages*, *Text messages*, *Message settings* and *Other settings*:

- Select *Message font size* to select between small and large fonts.
- Select *Message overwriting* to allow the automatic deletion of messages, if the memory is full.
- Select *Save to outbox when sending* to disable or enable the saving of sent messages to the outbox.

Settings for multimedia messages

Press **Menu**, and select *Messages*, *Multimedia msgs.* and *Message settings*. Select

- *Save sent messages*. Select *Yes* to save the sent multimedia messages in the *Sent items* folder. With setting *No*, the sent messages are not saved.
- *Allow multimedia reception*. Choose *No*, *Yes* or *In home network* to use multimedia service. *In home network* does not allow to receive multimedia messages when outside your home network.
- *Incoming multimedia messages*. Select *Retrieve* to download the multimedia messages automatically, or select *Reject*.
- *Allow adverts*. You can choose to allow or to reject advertisement.

Voice messages

Voice mailbox is a network service and you may need to subscribe to it first. For details, contact your service provider.

Press **Menu**, and select *Messages* and *Voice messages*. To call your voice mailbox, select *Listen to voice messages*. To key in, search for or edit your voice mailbox number, select *Voice mailbox number*.

If supported by the network, the indicator  will indicate new voice messages. Press **Listen** to call your voice mailbox number.



Tip: In standby mode, pressing and holding **111** calls your voice mailbox.

Minibrowser messages

Press **Menu**, and select *Messages, Multimedia msgs*. Press **Connect** to connect to the Internet and to display the messages. Press **Back** to finish the internet connection.

■ Call register (Menu 2)

The phone registers the phone numbers of missed, received and dialled calls, and the approximate length of your calls.



The phone registers if it is switched on and within the network's service area, and the network supports these functions.

Recent call lists

When you press **Options** in the *Missed calls*, *Received calls* or *Dialled numbers* menu, you can view the time and date of the call (*Time of call*), view (*View number*) or call (*Call*) the registered phone number, add it to the phone book (*Add to contact*), or delete (*Delete*) it from the list. You can also send a text message (*Send message*) to the registered number.

Select *Delete recent call lists* to clear lists of dialled, received and missed calls.

Call timers, Data/fax calls and Minibrowser



Note: The actual invoice for calls and services from your service provider may vary, depending upon network features, rounding-off for billing, taxes and so forth.

Press **Menu**, select *Call register* and then select *Call duration* to display the following list of counters and timers:

- *Last call duration* to show the approximate duration of your last call.
- *Dialled calls' duration* to show the approximate duration of your dialled calls since the last reset.
- *Received calls' duration* to show the approximate duration of your received calls since the last reset.
- *All calls' duration* to show the approximate duration of all dialled and received calls since the last reset.
- *Life timer* to show the duration of all dialled and received calls. This counter cannot be reset.

- *Clear timers* to reset all counters and timers to zero except the *Life timer*.

Press **Menu**, select *Call register* and then select *Data/fax calls* and scroll to check the amounts of sent and received data, and to clear the counters. The counters unit is a byte.

■ Contacts (Menu 3)



You can save names and phone numbers (contacts) in the phone's contacts directory.

- You may save names with numbers and textual notes for each name.
- For a certain number of names, you can save an image.

To access the **Contacts** menu:

- Press **Contacts** or **Go to** and select *Contacts*, or
- Press **Menu** and select *Contacts*.

Scroll with \vee or \wedge through the menus and select the menu by pressing **Select**. Select submenus and settings of your choice in the same way. Following menus are available:



Contacts





1. *Search* for names and display corresponding numbers.
2. *Add contact* to add a new contact name and number(s).
3. *Edit name* to change existing names.
4. *Delete* to erase all or single contacts from the **Contacts** directory.





5. *Add number* to add an additional number to an existing contact.
6. *Settings* to select how the names and numbers in contacts are displayed. Select *Memory status* to view the free and used memory capacity.
7. *Speed dials* to assign a number to a speed dialling key. To activate speed dialling see *Speed dialling* on page 43.
8. *Voice tags* to view the list of recorded voice tags. By selecting *Options* after highlighting an entry, you may *Playback*, *Change* or *Delete* the voice tag. For more information see *Voice* on page 54.
9. *Own number* to view the phone numbers assigned to your card. Only shown, if the numbers are included on your card.
10. *Caller groups* to arrange the names and phone numbers saved in the memory into caller groups with different ringing tones.

Searching for a name in contacts

To access the name list in *Contacts*:

- Press the selection key *Contacts* or *Go to* and select *Contacts*, then select *Search*, or
- Press *Menu* and select *Contacts*, then select *Search*, or
- From the idle menu press  or  (quick access).









Depending on your *Settings* an alphabetical list of names or the alphabetically first name and the corresponding number are displayed. Scroll with  or  through the names. Press *Details* and scroll with  or  through the stored numbers of the selected contact.

To access a name directly, begin typing the characters. The names fitting to your input are displayed. Scroll with  or  through the displayed names. Press **Details** and scroll with  or  through the stored numbers of the selected contact.

Saving multiple numbers, text items and an image per contact

You can save different types of phone numbers and short text items per name in the phone's contacts directory.

The first number saved is automatically set as the default number. It is indicated with a frame around the number type indicator. When you select a name from the contacts directory this number is used to make a call.

1. Scroll in the **Contacts** name list to the name to which you want to add a new number or text item, and press **Details**.
2. Press **Options** and select *Add number*, *Add detail* or *Add image*.
3. Select one of the following number types  *General*,  *Mobile*,  *Home*,  *Office* and  *Fax*, and key in the number, or detail-text types  *E-mail address*,  *Web address*,  *Postal address* and  *Note*, and key in the text item, or open *Graphics* in *Gallery* and scroll to the desired image. Press **Options** and select *Save to contacts*. A copy of the image is added to the contact.

Voice dialling

You can dial up to 15 stored phone book numbers using the voice dialling feature. Before you can place a call using voice dialling, you must first assign a voice tag to the number. Before using voice dialling, note that:

- Voice tags are not language dependent. They are dependent on the speaker's voice.
- Voice tags are sensitive to background noise. Record them and make calls in a quiet environment.
- When recording a voice tag or making a call by saying a voice tag, hold the phone in the normal position near to your ear.
- Very short voice tags are not accepted. Use long voice tags and avoid similar voice tags for different numbers.
- Unique tags are recognized more accurately. Consider using first and last name or first name, last name, and number type when tagging a number. Example: "John Smith, work."
- Avoid pauses or silence as you record the voice tag.
- If the voice tag memory is full, the phone displays *Memory full. Delete an existing voice tag?* Press **OK**, scroll to locate a tag to delete, then press **Delete**.
- The recording process stops automatically; pressing **Quit** aborts the recording attempt.
- Deleting a phone number deletes any associated voice tags.



Important: You must say the name exactly as you said it when you recorded it. This may be difficult in, for example, a noisy environment or during an emergency, so you should not rely solely upon voice dialling in all circumstances.





Warning! Do not use a voice tag for dialling emergency numbers. In emergencies, stress causes changes in your voice, which may keep the phone from recognizing your voice command.

Assign a voice tag to a phone number

You must record a voice tag (at least two seconds) for a phone number before you can use the voice dialling feature to dial it.

To add a voice tag to a phone book entry:

In standby mode, press  or , then scroll to the desired phone book entry, and press **Details**. Scroll to the phone number you want to tag and press **Options**. Scroll to **Add voice tag** and press **Select**.

Press **Start** and after the tone, speak the voice tag clearly into the microphone.



Note: Your phone informs you if the recording is not successful. Press **OK** to try again or **Back** to return to phone book.

The message **Voice tag saved** is displayed upon completion of the recording process. The icon  next to a phone number denotes that a voice tag exists for this number.

Dialling a number using voice dialling



Note: You must say the name exactly as you said it when you recorded it.

1. In standby mode, press and hold the right selection key (**Contacts** or **Go to**) for two seconds. A tone is heard and *Speak now* is displayed.
2. After the tone, clearly speak the voice tag that you recorded previously into the microphone.



Note: If the voice tag is not recognized by the phone or if you fail to speak a tag within three seconds after the tone, the message *Name not found* is displayed, and you are returned to the standby mode.

3. When the voice tag is recognized:

- The phone book entry will be displayed for three seconds.
- The voice tag is replayed (through the ear piece).
- After three seconds, the number is dialled.

The only other option for initiating voice dialling is to press the headset button momentarily while in standby mode. The alert tones play through the headset. Speak the voice tag into the headset microphone. The voice tag will playback through the headset to confirm your choice.

For further information on voice dialling and voice commands see [Voice](#) on page 54.

■ Profiles (Menu 4)

Your phone has various setting groups, called profiles, for which you can customise the phone tones for different events and environments.



Press **Menu**, and select *Profiles*. Scroll to a profile and press **Select**.

- To activate the selected profile, select *Activate*.
- To personalise the profile, select *Personalise*. Select the setting you want to change and make the changes.
- To set the profile to be active for a certain amount of time up to 24 hours, select *Timed* and set the end time. When the time set for the profile expires, the previous profile that was not timed, becomes active.

■ Settings (Menu 5)



Personal short-cuts

You can add some specific functions to your personal short-cut list and activate them either in standby mode by pressing the **Go to** key or accessing the *Go to* menu. Refer to [Standby mode](#) on page 9 and [Go to \(Menu 12\)](#) on page 69.

Press **Menu**, and select *Settings* and *Right selection key settings*.

To select the desired functions for your personal short-cut list, select *Select Go to options* and the list of available functions is shown. Scroll to the desired function and press **Mark** to add it to the short-cut list. To remove a function from the list, press **Unmark**.

To rearrange the functions on the list, select *Organise Go to options* and the desired function. Press **Move** and select where you want to move the function.

Call settings

Anykey answer

Press **Menu**, and select *Settings*, *Call settings* and *Anykey answer*. Select *On* and you can answer an incoming call by briefly pressing any key, except **0**, selection key **—** (*Silence*), and .

Automatic redial

Press **Menu**, and select *Settings*, *Call settings* and *Automatic redial*. Select *On* and your phone will make up to 10 attempts to connect the call after an unsuccessful call attempt.

Speed dialling

Press **Menu**, and select *Settings*, *Call settings* and *Speed dialling*. Select *On* and the names and phone numbers assigned to the speed dialling keys, from **2^{ABC}** to **9^{WXYZ}**, can be dialled by pressing and holding the corresponding number key.

Automatic service update

Your phone is capable of receiving updates to wireless services sent to your phone by your service provider.

Press **Menu**, and select *Settings*, *Call settings* and *Automatic service update* to activate or deactivate.

Calling card

If you wish to use a calling card for long distance calls, you can first save your calling card information into your phone. Your phone is equipped to handle up to four calling cards.

Saving Calling card information

1. Press **Menu**, and select *Settings, Call settings* and *Calling card*.
2. Type in the security code and press **OK**.
3. Select the desired Card (Card A - D) and press **Options** to activate the card.
4. Select *Edit* to create or change a card.
5. Scroll to one of the three sequence types as described below, then press **Select**.
 - *Access no.+ phone no.+ card no.*
Dial the calling card access number (such as 1-800), then phone number, then card number.
 - *Access no.+ card no.+ phone no.*
Dial the calling card access number, then card number, then phone number.
 - *Prefix+ phone no.+ card no.*
Dial the prefix (any numbers that must precede the phone number) and phone number want to dial, then card number.
6. Enter the required information (access number or prefix and card number) and press **OK**.

To rename the calling card

1. Scroll to *Card name*; then press **Select**.
2. Enter the card name, then press **OK**.

Making calling cards calls

1. Enter the phone number, including any prefix (such as 0 or 1) that your calling card may require when you make a calling card call. See your calling card for instructions.
2. Press and hold  for a few seconds until your phone displays *Card call*.
3. Your phone displays *Wait for tone, then press OK*. When you hear the tone or system message, press **OK**.
4. Your phone displays *Again, press OK after tone*. When you hear the tone or system message, press **OK**.

Phone settings

Phone language

Select the language the phone shall display. Press **Menu**, and select *Settings*, *Phone settings* and *Phone language*.

Automatic keyguard



Note: When the keypad is locked, calls may be possible to the emergency number programmed into your phone (e.g. 112, 911 or other official emergency numbers). Key in the emergency number and press . The number is displayed only after you have keyed in its last digit.

Press **Menu**, and select *Settings*, *Phone settings* and *Automatic keyguard*. Select *On* and key in the time delay (minutes:seconds). The keypad automatically locks in standby mode after the time delay to prevent accidental keypresses. Refer also [Keypad lock \(Keyguard\)](#) on page 14.

DTMF tones

DTMF tones are sounds that are produced when you press the keys on your phone's keypad.

You can use DTMF tones for many automated over-the-phone services such as checking bank balances and airline schedules and using your voice mailbox. Those features depend on operator's availability. DTMF tones can be sent only when a call is active.

Press **Menu**, and select *Settings, Phone settings* and *DTMF tones*.

To choose the *DTMF tones* options select *Manual DTMF tones*.

- *Continuous* - Tone sounds for as long as you press and hold a key.
- *Fixed* - Sets the tone to a fixed tone length.
- *Off* - No tones are sent when you press a key.

To adjust the fixed tone length, select *DTMF tone length*:

- *Short* - Fixed tone length of 0.1 sec.
- *Long* - Fixed tone length of 0.5 sec.

Welcome note

Press **Menu**, and select *Settings, Phone settings* and *Welcome note*. Key in the note which is shown briefly when the phone is switched on.

Help text activation

To set the phone to show or not to show the help texts, press **Menu**, and select *Settings, Phone settings* and *Help text activation*.

Time and date settings

Press **Menu**, and select *Settings, Time and date settings*.

Select *Clock* to set the phone to show the clock in standby mode, adjust the clock and select the time format.

Select *Date* to set the phone to show the date in standby mode, set the date, the date format and the date separator.

Select *Auto-update of date & time* (network service) to set the phone to update the time and date according to the current time zone.

The automatic update of the date and time does not change the time that you have set for the alarm clock, calendar or the alarm notes. They are in local time. Updating may cause some alarms that you have set to expire.

Display settings

Wallpaper

Let your phone display a background picture (wallpaper) from *Gallery* menu when the phone is in standby mode.

To select a picture, press **Menu**, and select *Settings, Display settings* and *Wallpaper*. Select *Select wallpaper* and choose a picture from a folder in the *Gallery*. To set the picture as the wallpaper, press **Options** and select *Set as wallpaper*. To activate/deactivate the wallpaper, select *On/Off*, respectively.

Colour schemes

To change the colour in some display components, for example, indicators and signal bars, press **Menu**, and select *Settings*, *Display settings* and *Colour schemes*.

Banner

This function can be used only if it is supported by your network operator or service provider. Please contact your service provider for more information.

Display brightness

To change the display contrast level used on the phone display, press **Menu**, and select *Settings*, *Display settings* and *Display brightness*. Use **(** and **)** to adjust the contrast level.

Tone settings

You can change the settings of the selected active profile.

Press **Menu**, and select *Settings* and *Tone settings*. Select and change *Incoming call alert*, *Ringtone*, *Rhythmic backlight alert*, *Ringtone volume*, *Vibrating alert*, *Message alert tone*, *Keypad tones*, *Warning tones* and *Alert for*. You can find the same settings in the *Profiles* menu, see [Profiles \(Menu 4\)](#) on page 41.

Select *Alert for* to set the phone to ring only upon calls from phone numbers that belong to a selected caller group. Scroll to the caller group you want or *All calls* and press **Mark**.

Enhancement settings

This menu is shown only if the phone is or has been connected to some compatible Nokia audio enhancements, for example to a headset, or a radio, or a camera.

Press **Menu**, and select *Settings* and *Enhancement settings*. Select one of the displayed enhancements (*Handsfree*, *Headset*, *Loopset*, *Text phone*).

Select *Default profile* to select the profile the phone uses when the enhancement is connected.

Select *Automatic answer* to set the phone to automatically answer an incoming call after five seconds. If the *Incoming call alert* is set to *Beep once* or *Off*, automatic answer will not be available.

Select *Lights* to set the lights permanently *On*. Select *Automatic* to set the lights on for 15 seconds after a keypress. The *Lights* option is available only when *Handsfree* is selected.

Security settings

Press **Menu**, and select *Settings* and *Security settings* to change the security code, to define call restrictions and to set up the *Phone lock*.



Note: When security features that restrict calls are in use (*Restrict outgoing calls*), calls may be possible to certain emergency numbers in some networks (e.g. 112, 911 or other official emergency numbers).

Phone lock

With *Phone lock* set to *On*, you can prevent unauthorized use of your phone by a lock code and only incoming calls and calls to the unlocked phone number (see below) are allowed.

Allowed no. when phone is locked

To allow calls to certain numbers when the phone is locked select *Allowed number when lock active*.

Change security code

Your phone prompts you for a five-digit **security code** for certain features and commands. Access is granted only after the correct security code has been entered successfully. The default security code is **12345**. It is recommended that you change this code at once, write it down, and store it in a safe place away from your phone.

Press **Menu**, and select *Settings, Security settings* and then *Change security code*.

Call restrictions

Press **Menu**, and select *Settings, Security settings* and then *Call restrictions* to restrict incoming or outgoing calls to a defined list of numbers. Type in your security code to get access to this menu. For *Restrict outgoing calls* and *Restrict incoming calls* the following options are available: *Select* to select numbers to be restricted from a list, *Add restriction* to add a number and name to the restriction list, *Edit* to change numbers or names in the restriction list, and *Delete* to erase numbers and names from the restriction list.

Voice Privacy

Some service provider's networks can encrypt the signal transmitted during a phone call to ensure others are unable to listen to your conversation. To turn *Voice privacy* (network service) on, press **Menu**, select *Settings, Security settings* and then *Voice privacy*). Scroll to *OK*, then press **OK**.

During a call, if voice privacy is lost, your phone sounds two short beeps.

Network

The *Network* menu allows you to modify how your phone will work when you are outside of your primary or "home" network (Roaming). How your phone will handle being out of your home area can significantly affect the types and amounts of additional charges you may incur.



Note: Before making modifications to your network selection setup, contact your service provider to ascertain how these changes may affect your phone bill.

Network services

Call divert, Call waiting, and Send my caller ID are network services available through your service provider. These features do not appear in your phone's *Network services* menu until you save the related feature code(s) given to you by your service provider. After you save the feature activation or cancellation code, the feature appears in the phone's menu and you can use the menu to turn the feature on or off. To save a network feature activation code, use the Menu *Network feature setting* (see below).



Note: Feature codes can be saved only when your default phone number (NAM 1) is selected. See *My number selection* below.

Call divert

Press **Menu**, and select *Settings, Network Services* and then *Call divert* (network service) to divert your incoming calls. For details, contact your service provider.

To set the divert setting to on, select *Activate*, and then select the timeout after which the call is diverted, if this is available for the divert option. Several divert options may be active at the same time. To set the divert setting to off, select *Cancel*. To cancel all call divers at once, select *Cancel all call divers*.

Call waiting

If *Call waiting* is activated, your phone beeps during a call to let you know that someone else is calling you. Depending on your caller ID setup, the phone might also show the number of the incoming call.

Press **Menu**, select *Settings, Network Services* and then *Call waiting* and *Activate* or *Cancel* the feature.

Send my caller identity

If *Send my caller ID* is activated, you can determine, for each call you make, whether your telephone number appears on another phone's caller ID.

Press **Menu**, select *Settings, Network Services* and then *Send my caller ID* and select *Yes* or *No* the feature.

Network feature setting

To save a network feature activation code for activation, press **Menu**, select *Settings, Network Services* and then *Network feature setting*. Type in the feature code provided by your network service and press **OK**.

My number selection

The number assigned to your phone provides service for only one service area. Your phone can be activated in up to three different service areas, however. Each service area would assign a different phone number or account to your phone. You must select a phone number for your home network, and if you travel outside your home network, you can choose another number. Only one phone number can be active at a time.



Note: It might not be necessary to have up to two numbers for your phone if your service provider has service or roaming agreements for each area in which you wish to use your phone. Contact your service provider for details.

To set your own number according to the service area, press **Menu**, select *Settings, Network Services* and then *My number selection*

Restore factory settings

To reset some of the menu settings to their original values, press **Menu**, and select *Settings* and *Restore factory settings*. Key in the security code. The names and phone numbers saved in the contacts list are not deleted.

■ Gallery (Menu 6)



You can save images and ringing tones, for example, if received in a multimedia message, in the folders of the gallery, see [Reading and replying to a multimedia message](#) on page 31. The gallery uses shared memory.



Note: Your phone must be switched on to use this function. Do not switch the phone on when wireless phone use is prohibited or when it may cause interference or danger.

To view the folders, press **Menu**, and select *Gallery* and *View folders*. The list of options is shown. Open the desired folder and the list of files in the folder is shown. Scroll to the desired file. Press **Options** and some of the following options may be available: *Open, Delete, Edit, Move, Rename, Set as wallpaper, Set as ring tone, Details* and *Sort*.

Other options are: *Add folder, Delete folder* and *Rename folder*.

■ Voice (Menu 7)



This menu allows you to record memos and phone calls, access existing voice tags and add or change voice commands.

Voice tags

Press **Menu**, and select *Voice* and *Voice tags* to display a list of existing voice tags. You may select a voice tag and *Playback, Change* or *Delete* it.

Voice commands

Press **Menu**, and select *Voice* and *Voice commands* to add voice commands for the activation of following features:

- *Profiles: General, Silent, Meeting, Outdoor, Pager*
- *Voice mailbox: Call voice mailbox*
- *Recorder: Record*
- *Call register: Missed calls, Received calls*

Select a feature and press **Options**:

- *Add command* is displayed if there is no voice command attached.
- If there is already a voice command attached you may *Playback, Change* or *Delete* the attached voice command.

Voice recorder

Voice recorder allows you to record audio memos and store them in your phone. Use this feature to record things such as phone numbers and personal memos. Total time available for all memos are 3 minutes .

Press **Menu**, and select *Voice* and *Voice recorder*.

To record a memo select *Record*. The recording starts immediately when you press **Select**, and is finished when you press **Stop**. Type in a name for the recording an save it to the *Recordings list*.

To handle stored memos select *Recordings list* and select following options: *Playback, Delete, Edit title* and *Alarm*. With the option *Alarm* you may add (edit, or remove) a reminder alarm for the memo.

■ Organiser (Menu 8)

The *Organiser* menu includes features that assist you in organising daily tasks.



Alarm clock

You can set the phone to alarm at a desired time. Press **Menu**, and select *Organiser* and *Alarm clock*.

To set the alarm, select *Alarm time* and key in the alarm time. To change the time when the alarm time is set, select *On*.

To set a tone for the alarm, select *Alarm tone* and the desired tone.

When the alarm time expires

The phone will sound an alert tone, and flash *Alarm!* and the current time on the display, even if the phone was switched off. Press **Stop** to stop the alarm. If you let the phone alarm for a minute or press **Snooze**, the alarm stops for about ten minutes and then resumes.

If the alarm time is reached while the phone is switched off, the phone switches itself on and starts sounding the alarm tone. If you press **Stop**, the phone asks whether you want to activate the phone, *Switch the phone on?* Press **No** to switch off the phone or **Yes** to switch on the phone.



Note: Do not press **Yes** when wireless phone use is prohibited or when it may cause interference or danger.

Calendar

The calendar uses shared memory.



Note: Your phone must be switched on to use the functions in the *Calendar* menu. Do not switch the phone on when wireless phone use is prohibited or when it may cause interference or danger.

Press **Menu**, and select *Organiser* and *Calendar*.

The current day is indicated with a frame. A day with a note appears in bold. To view the day notes, scroll to a day, press **Options** and select *Day notes*.







To view a single note, press **Options** and select *View*.



Other options for the calendar view may be:

- Options for making a note, sending a note to another phone, copying a note to another day or deleting, editing, moving and repeating a note.
- *Settings* to set the date, time, date or time format, or the first day of the week. In the *Auto-delete* option you can set the phone to delete old notes automatically after a specified time.

Making a calendar note

Press **Menu**, select *Organiser* and *Calendar*. Scroll to the date you want, press **Options** and select *Make a note*. Select one of the following note types:  *Call*,  *Memo*,  *Meeting*,  *Reminder*, or  *Birthday*.

When the phone alarms for a note

The phone beeps and displays the note. With a call note , you can call the displayed number by pressing . To stop the alarm and view the note, press **View**. To stop the alarm without viewing the note, press **Exit**.

To-do list

You can keep track of your tasks with the to-do list feature. You may be able to save up to 30 notes, depending on their length.

To access the to-do list, press **Menu**, and select *Organiser* and *To-do list*. If the to-do list contains notes, the to-do list is displayed.

With *Options* you may *Add*, *View*, *Delete* and *Edit* to-do notes. You can set and change the priority of to-do notes to *High* (1), *Medium* (2) or *Low* (3). With the option *Save to calendar* you may save a to-do note as calendar note.

Calculator

The phone is provided with a calculator which can also be used for rough currency conversions.

Note: This calculator has a limited accuracy and rounding errors may occur, especially in long divisions.

To access the calculator, press **Menu**, and select *Organiser* and *Calculator*.

Making calculations

The keys **0-9** - **0x9z** insert a digit. **0#** inserts a decimal point. To delete the last digit, press **Clear**. To change the sign, press **Options** and select *Change sign*. Press ***+** once for "+", twice for "-", three times for "*" or four times for "/". To get the result, press **Options** and select *Equals*. To clear the display for a new calculation, press and hold **Clear**.

Making a currency conversion

To save the exchange rate: Press **Options**, and select *Exchange rate*. Select *Foreign unit in domestic units* or *Domestic unit in foreign units*, and key in the value (press **0#** for a decimal point).

To make the conversion: key in the currency amount to be converted, press **Options**, and select *In domestic* or *In foreign*.

Countdown timer

You can set the alarm to sound after a period of lapsed time.

Press **Menu**, and select *Organiser* and *Countdown timer*. Key in the alarm time and if desired a note. When the timer is running, **0** is shown in standby mode. To change the countdown time, select *Change time*, or to stop the timer, select *Stop timer*.



When the alarm time is reached, the phone sounds a tone and flashes the related text. Press any key to stop the alarm.

Stopwatch

Press **Menu**, and select *Organiser* and *Stopwatch*. Select *Split timing* or *Lap timing*, and press **Start**. Press **Split** to record a split time, **Lap** to record a lap time or **Stop** to finish timing. You can scroll through the recorded times shown below the overall time.

When the timing is stopped, you can press **Options** for *Start* (split times only), *Save*, or *Reset*. If you select *Start*, timing continues from the previously timed event. If you select *Reset*, the split or lap times are reset.

Setting the timing to continue in the background

While the time is running, press . When the stopwatch is on,  is shown in standby mode. To view the timing, go to the *Stopwatch* menu and select *Continue*.

Running the stopwatch consumes battery. Be careful not to let it run unintentionally in the background.

Calorie counter

The *Calorie counter* estimates calories burned during activities.

To access the *Calorie counter*, press **Menu**, and select *Organiser* and *Calorie counter*.

To set up the *Calorie counter* select *Settings* and enter your *Weight*, *Age* and *Gender*. Additionally you may set the *Weight format*, *Calorie format* and *Velocity format*.

To display your personal activity list select *Activities*. With *Options* you may add new activities to your personal activity list, change parameters of a selected

activity, calculate the number of total calories or delete activities from your personal activity list.

■ Minibrowser(Menu 9)



Note: Your phone must be switched on to use this function. Do not switch the phone on when wireless phone use is prohibited or when it may cause interference or danger.



Important: This feature is available only if your service provider's network supports mobile internet access. Your service provider may also require that you subscribe to this additional service. For more information, contact your service provider.

The *Minibrowser* feature allows you to access special Internet content designed specifically for viewing from your mobile phone. You can use your phone's minibrowser to view news, get weather reports, check flight times, access financial information, download new ringing tones or graphics, etc. The browser's menu allows you to save addresses of Web sites as bookmarks, so you can return to your favourite sites quickly and easily.

Browsing sessions and indicators

When you launch the minibrowser, two icons appear on the screen:



Minibrowser icon - minibrowser session active



Active call icon - you are being billed accordingly



Note: The minibrowser disconnects you from the network after a period of inactivity. This is normal and is designed to minimize your bill. You may find, however, that you are billed for several network connections within a single session.

When the minibrowser disconnects from the network, only the browser icon  remains. While browsing, you can still access pages stored in memory without being connected to the Internet. However, if you navigate to a page that is not stored in the memory, a new connection is established and you'll be billed accordingly.

Launching and terminating the Minibrowser

The first time you launch the minibrowser, you go through a security setup process that takes three to five minutes. Follow the on-screen prompts.

To launch the minibrowser:

Press **Menu**, and select *Minibrowser*, then press **Connect** or press and hold  from the standby mode.

If a confirmation note appears, press **Yes**. After a few seconds the home page of your provider appears.





To terminate a browsing session, press and hold  or use *Exit web* from the minibrowser menu (see below).

Minibrowser menu

While browsing, press and release the  key to display the minibrowser menu:

1. *Home* - to call the Homepage of your provider
2. *Back* - to go to the previous page
3. *Add bookmark* - to bookmark a visited page
4. *View bookmarks* - to list all saved bookmarks
5. *Search* - to launch a search page customized by your provider
6. *Go to URL* - to enter a URL address and to access the corresponding site
7. *Show URL* - to display the URL of the current page
8. *Instructions* - to display tips
9. *Save items* - to save item like pictures or ringing tones
10. *Other options* - to access history and setting features
11. *Refresh* - to reload the current page
12. *Exit web* - to end the browsing session

Navigate in the minibrowser

- Use  and  to scroll through menus and pages.
- Press  to go back to a previous page.
- To go to the Homepage, press  to display the minibrowser menu, scroll to *Home*, then press **OK**.
- Links appear usually as items in a numbered list. When activated, a link will take you to another page, other site or will make a phone call.
- To select or open an item (for example a link):

- If the item on the page is numbered, press the appropriate number on your phone's keypad. – OR –
- Scroll to the item, then press the appropriate selection key (for example **Select** or **Open**).



Note: If you activate a link which makes a phone call, the browser connection terminates and the current page is stored in the memory. When you end the call, the page you were viewing is displayed again and you can continue browsing.

Bookmarks

- You can create a bookmark for a page to return to that page later on:
 - Press **1** to access the minibrowser menu.
 - Scroll to **Add bookmark** and press **Select**.
 - To access a bookmarked page:
 - Press **1** to access the minibrowser menu.
 - Scroll to **View bookmarks** and press **OK** to display the list of bookmarks.
 - Scroll to the desired bookmark and press **Select**.
-  **Tip:** The first ten bookmarks are assigned to keys **1-0** to **0 _**. Press and hold the number associated with the desired bookmark to go to the bookmarked site at any time during a browser session.

Minibrowser messages

Depending on your service provider, you may be able to receive text messages via the minibrowser. Unlike SMS text messages, minibrowser messages are not stored in the phone and must be accessed via the minibrowser's homepage.

Notification of new minibrowser messages

When a new minibrowser message is received, the icon  appears in the status bar. Depending on the message priority, you may also hear an alert tone and/or see *New web message* is displayed.

- If you receive the message while browsing, press **View** to read the message or **Skip**, allowing you to view the message later.
- If you receive the message while phone is idle, press **Connect** to launch the browser and view the message, or press **Back** to return to the standby mode.

You can use *Minibrowser messages* in the *Messages* menu to read your messages at a later time, see [Minibrowser messages](#) on page 34.

Weblinks in minibrowser messages

You can receive minibrowser messages containing Web links. If you receive a message containing a link, select *Use Web link* from the message's Options menu to open the link and go to the Web site.

You can also receive Web links in standard SMS messages. Selecting *Use Web link* from the message's Options menu launches the minibrowser and takes you to the link's Web site.

■ Games (Menu 10)



Your phone software includes some games specially designed for this Nokia phone.



Note: Your phone must be switched on to use this function. Do not switch the phone on when wireless phone use is prohibited or when it may cause interference or danger.

Launching a game

Press **Menu**, and select *Games* and *Select game*. Select a game or a game set, press **Options** and select *Open* or press .

Other options for games, see [Other options available for an application](#) on page 67.

Memory

The games use shared memory. To view the size of memory available for game installations, press **Menu**, and select *Games* and *Memory*.

Game settings

Press **Menu**, and select *Games* and *Settings* to set sounds, lights and shakes for the game.

■ Applications (Menu 11)

Your phone software includes some Java™ applications specially designed for this Nokia phone.



Note: The phone must be switched on to use this function. Do not switch on the phone when the use of a wireless phone is prohibited or when it may cause interference or danger.

Launching an application

Press **Menu**, and select *Applications* and *Select application*. Scroll to an application, press **Options** and select *Open* or press .

Other options available for an application

- *Delete* to delete the application from the phone.
- *Web access* to restrict the application from accessing the network.
- *Update version* to check if a new version of the application is available for download from the services if supported by the application.
- *Web page* to provide further information or additional data for the application from an Internet page. This feature needs to be supported by the network. It is only displayed if an Internet address has been provided with the application.
- *Connect via* the specific default settings that some applications need for the browser.
- *Details* to give additional information about the application.

Downloading an application

Your phone supports J2ME™ Java™ applications. Make sure that the application is compatible with your phone before downloading it. You can download new Java applications in different ways:

- Press **Menu**, and select *Applications* and *Browser downloads*. The list of available bookmarks is shown. Select *More bookmarks* to access the list of bookmarks in the *Services* menu, see [Bookmarks](#) on page 64.
Select the appropriate bookmark to connect to the desired page. For the availability of different services, pricing and tariffs, contact your service provider.
- Use the Nokia Application installer from PC Suite to download the applications from a compatible PC in your phone.



Note: Nokia does not warrant for applications from non-Nokia sites. If you choose to download Java applications from them, you should take the same precautions, for security or content, as you would with any site.

Note that when downloading a game or an application, it may be saved in *Games* menu instead of the *Applications* menu.

The applications use shared memory. To view the size of memory available for application installations, press **Menu**, and select *Applications* and *Memory*.

The following texts may appear during a download or during an operation of a Java application: *Action failed, Application error, Application not supported, Call in progress, File format unknown, File too large, Invalid file, Unable to start, Unable to run application, Unknown*.

■ Go to (Menu 12)



To access some specific functions quickly, press **Menu** and select **Go to** and select the desired function from the list.

If there are no functions on the list, press **Select Go to options**, scroll to the function that you want to add to the list and press **Mark**.

To sort, remove or add more functions on the list, see [Personal short-cuts](#) on page 42.

5. PC Connectivity

With Nokia PC Suite you can, for example, create and send text and picture messages, synchronise contacts and calendar between your phone and a compatible PC.

You may find more information and downloadable files in the support area on the Nokia Web site at <http://www.nokia.com>.

■ Nokia PC Suite

Nokia PC Suite contains the following features:

- **Nokia Application Installer** to install Java applications from the PC to the phone.
- **Nokia Image Converter** to make images usable for multimedia messages or wallpapers and to transfer them to your phone.
- **Nokia Sound Converter** to edit polyphonic ringing tones to be compatible with your phone and to transfer them to your phone.
- **Nokia Content Copier** to copy information or back-up information from your phone to the PC or to another compatible Nokia phone.
- **Nokia Phone Editor** to send text messages and edit the contacts directory and message settings of your phone.
- **Nokia PC Sync** to synchronise the contacts directory and calendar between your phone and a compatible PC.

- **Nokia Connection Manager** to select the connection type between the PC and the phone.
- **Nokia Phone Browser** to copy images and tones from your phone to your PC and vice versa.



Note: Copyright protection may prevent some images, ringing tones and other content from being copied, modified, transferred or diverted.

6. Battery information

■ Charging and discharging

Your phone is powered by a rechargeable battery.

Note that a new battery's full performance is achieved only after two or three complete charge and discharge cycles.

The battery can be charged and discharged hundreds of times but it will eventually wear out. When the operating time (talk-time and standby time) is noticeably shorter than normal, it is time to buy a new battery.

Use only batteries approved by the phone manufacturer and recharge your battery only with the chargers approved by the manufacturer. Unplug the charger when not in use. Do not leave the battery connected to a charger for longer than a week, since overcharging may shorten its lifetime. If left unused a fully charged battery will discharge itself over time.

Temperature extremes can affect the ability of your battery to charge.

Use the battery only for its intended purpose.

Never use any charger or battery which is damaged.

Do not short-circuit the battery. Accidental short-circuiting can occur when a metallic object (coin, clip or pen) causes direct connection of the + and - terminals of the battery (metal strips on the battery) for example when you carry a spare battery in your pocket or purse. Short-circuiting the terminals may damage the battery or the connecting object.

Leaving the battery in hot or cold places, such as in a closed car in summer or winter conditions, will reduce the capacity and lifetime of the battery. Always try to keep the battery between 15°C and 25°C (59°F and 77°F). A phone with a hot or cold battery may

temporarily not work, even when the battery is fully charged. Batteries' performance is particularly limited in temperatures well below freezing.

Do not dispose of batteries in a fire.

Dispose of batteries according to local regulations (e.g. recycling). Do not dispose as household waste.

■ Battery performance

This section provides information about the charging times with the Standard Travel Charger (ACP-7), and the talk and standby times. Consult your service provider for more information.

Charging Times

Charging times for the BL-5C Li-ion Battery are approximate.

Battery option	ACP-7	ACP-12
BL-5C Li-ion	3 hr 3 min	1 hr 15 min

Standby and Talk Times

Mode	Talk time	Standby time
Digital	Up to 3.5 hrs - 4 hrs	Up to 9 - 14 days



Battery talk and standby times are estimates only and depend on signal strength, network conditions, features used, battery age and condition (including the effect of charging habits), temperatures to which battery is exposed, use in digital mode, and many other factors. Please note that the amount of time a phone is used for calls will affect its standby time. Likewise, the amount of time that the phone is turned on and in standby mode will affect its talk time.

7. Mobile enhancements

If you want to enhance your phone's functionality, a range of accessories is available for you. You can select any of these items to help accommodate your specific communication needs. For availability of these and other accessories, contact your service provider.



■ A few practical rules for accessory operation

- Keep all accessories out of the reach of small children.
- When you disconnect the power cord of any accessory, grasp and pull the plug, not the cord.
- Check regularly that any vehicle-installed accessories are mounted and are operating properly.
- Installation of any complex car accessories must be made by qualified personnel only.
- Use only batteries, chargers, and accessories that have been approved by Nokia. The use of any other types could invalidate any approval or warranty applying to the phone and could be dangerous.

■ Chargers and other accessories

Check the model number of any charger before use with your device. This device is intended for use when supplied with power from ACP-7, ACP-12, or LCH-12.



Use only batteries, chargers, and accessories approved by Nokia for use with this particular phone model. The use of any other types may invalidate any approval or warranty applying to the phone and may be dangerous.

For availability of approved accessories, please check with your dealer.

When you disconnect the power cord of any accessory, grasp and pull the plug, not the cord.

Standard Charger (ACP-7)

This is a lightweight and durable ac charger.

To use the standard travel charger, plug it into a standard ac wall outlet and connect the lead from the charger to the base of your phone.

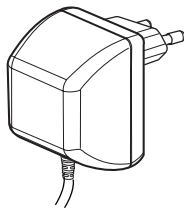

If the battery is completely empty, you cannot use the phone until it has enough charge to operate.

Travel Charger (ACP-12)

This is a lightweight and durable ac charger. To use the standard travel charger, plug it into a standard ac wall outlet and connect the lead from the charger to the base of your phone.

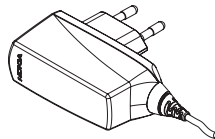

Headset (HDB-4)

Small and lightweight, the Boom Headset fits over the ear. This headset has excellent audio quality with the microphone and speaker integrated into the unit. The Boom Headset provides basic handsfree functionality with an answer/end button.



Headset (HS-5)

Small and lightweight, this headset fits over the ear. This headset has excellent audio quality with the microphone and speaker integrated into the unit. The headset provides basic handsfree functionality with an answer/end button.



Connectivity Adapter Cable (DKU-5)

Easy and convenient connection to your PC or laptop computer for wireless modem functionality.

DKU-5 is a USB cable that can be used with Nokia PC Suite.

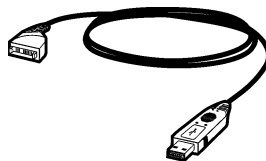

Loopset (LPS-4)

With the Nokia Loopset, people who use a T-coil equipped hearing aid have the freedom to talk on a digital mobile phone. The loopset goes around your neck so it can be worn comfortably and discreetly.

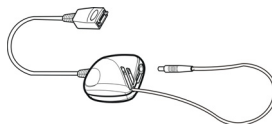

■ Nokia Xpress-on™ colour covers

The Xpress-on cover is available in several fashion colours. Xpress-on covers may be purchased from your authorised Nokia dealer.



Before changing the cover, always switch off the power and disconnect the phone from the charger or any other device. Always store and use the phone with the covers attached.

Care and maintenance

Your phone is a product of superior design and craftsmanship and should be treated with care. The suggestions below will help you to fulfil any warranty obligations and to enjoy this product for many years.

- Keep the phone and all its parts and accessories out of the reach of small children.
- Keep the phone dry. Precipitation, humidity and all types of liquids or moisture can contain minerals that will corrode electronic circuits.
- Do not use or store the phone in dusty, dirty areas. Its moving parts can be damaged.
- Do not store the phone in hot areas. High temperatures can shorten the life of electronic devices, damage batteries, and warp or melt certain plastics.
- Do not store the phone in cold areas. When it warms up (to its normal temperature), moisture can form inside, which may damage electronic circuit boards.
- Do not attempt to open the phone. Non-expert handling may damage it.
- Do not drop, knock or shake the phone. Rough handling can break internal circuit boards.
- Do not use harsh chemicals, cleaning solvents, or strong detergents to clean the phone.
- Do not paint the phone. Paint can clog the moving parts and prevent proper operation.
- Use only the supplied or an approved replacement antenna. Unauthorised antennas, modifications or attachments could damage the phone and may violate regulations governing radio devices.

All of the above suggestions apply equally to your phone, battery, charger or any accessory. If any of them is not working properly, take it to your nearest qualified service facility. The personnel there will assist you and, if necessary, arrange for service.

Important safety information

■ Traffic Safety

Do not use a hand-held telephone while driving a vehicle. Always secure the phone in its holder; do not place the phone on the passenger seat or where it can break loose in a collision or sudden stop.

Remember road safety always comes first!

■ Operating environment

Remember to follow any special regulations in force in any area and always switch off your phone whenever it is forbidden to use it, or when it may cause interference or danger.

Use the phone only in its normal operating positions.

Parts of the phone are magnetic. Metallic materials may be attracted to the phone, and persons with a hearing aid should not hold the phone to the ear with the hearing aid. Always secure the phone in its holder, because metallic materials may be attracted by the earpiece. Do not place credit cards or other magnetic storage media near the phone, because information stored on them may be erased.

■ Electronic devices

Most modern electronic equipment is shielded from radio frequency (RF) signals. However, certain electronic equipment may not be shielded against the RF signals from your wireless phone.

Pacemakers

Pacemaker manufacturers recommend that a minimum separation of 20 cm (6 inches) be maintained between a handheld wireless phone and a pacemaker to avoid potential interference with the pacemaker. These recommendations are consistent with the independent research by and recommendations of Wireless Technology Research. Persons with pacemakers:

- Should always keep the phone more than 20 cm (6 inches) from their pacemaker when the phone is switched on.
- Should not carry the phone in a breast pocket.
- Should use the ear opposite the pacemaker to minimise the potential for interference.
- If you have any reason to suspect that interference is taking place, switch off your phone immediately.

Hearing aids

Some digital wireless phones may interfere with some hearing aids. In the event of such interference, you may want to consult your service provider.

Other medical devices

Operation of any radio transmitting equipment, including cellular phones, may interfere with the functionality of inadequately protected medical devices. Consult a physician or the manufacturer of the medical device to determine if they are adequately shielded from external RF energy or if you have any questions. Switch off your phone in health care facilities when any regulations posted in these areas instruct you to do so. Hospitals or health care facilities may be using equipment that could be sensitive to external RF energy.

Vehicles

RF signals may affect improperly installed or inadequately shielded electronic systems in motor vehicles (e.g. electronic fuel injection systems, electronic anti-skid (anti-lock) braking systems, electronic speed control systems, air-bag systems). Check with the manufacturer or its representative regarding your vehicle. You should also consult the manufacturer of any equipment that has been added to your vehicle.

Posted facilities

Switch your phone off in any facility where posted notices so require.

■ Potentially explosive atmospheres

Switch off your phone when in any area with a potentially explosive atmosphere and obey all signs and instructions. Sparks in such areas could cause an explosion or fire resulting in bodily injury or even death.

Users are advised to switch off the phone when at a refuelling point (service station). Users are reminded of the need to observe restrictions on the use of radio equipment in fuel depots (fuel storage and distribution areas), chemical plants or where blasting operations are in progress.

Areas with a potentially explosive atmosphere are often but not always clearly marked. They include below deck on boats; chemical transfer or storage facilities; vehicles using liquified petroleum gas (such as propane or butane); areas where the air contains chemicals or particles, such as grain, dust or metal powders; and any other area where you would normally be advised to turn off your vehicle engine.

■ Vehicles

Only qualified personnel should service the phone, or install the phone in a vehicle. Faulty installation or service may be dangerous and may invalidate any warranty which may apply to the unit.

Check regularly that all wireless phone equipment in your vehicle is mounted and operating properly.

Do not store or carry flammable liquids, gases or explosive materials in the same compartment as the phone, its parts or accessories.

For vehicles equipped with an air bag, remember that an air bag inflates with great force. Do not place objects, including both installed or portable wireless equipment in the area over the air bag or in the air bag deployment area. If in-vehicle wireless equipment is improperly installed and the air bag inflates, serious injury could result.

Using your phone while in the air is prohibited. Switch off your phone before boarding an aircraft. The use of wireless telephones in an aircraft may be dangerous to the operation of the aircraft, disrupt the wireless telephone network and may be illegal.

Failure to observe these instructions may lead to suspension or denial of telephone services to the offender, or legal action or both.



■ Emergency calls



Important: This phone, like any wireless phone, operates using radio signals, wireless and landline networks as well as user-programmed functions. Because of this, connections in all conditions can not be guaranteed. Therefore, you should never rely solely upon any wireless phone for essential communications (e.g. medical emergencies).

Emergency calls may not be possible on all wireless phone networks or when certain network services and/or phone features are in use. Check with local service providers.

To make an emergency call:

1. If the phone is not on, switch it on. Check for adequate signal strength. Some networks may require that a valid card is properly inserted in the phone.
2. Press  as many times as needed (e.g. to exit a call, to exit a menu, etc.) to clear the display and ready the phone for calls.
3. Key in the emergency number for your present location (e.g. 112, 911 or other official emergency number). Emergency numbers vary by location.
4. Press the  key.

If certain features are in use, you may first need to turn those features off before you can make an emergency call. Consult this guide and your local cellular service provider.

When making an emergency call, remember to give all the necessary information as accurately as possible. Remember that your wireless phone may be the only means of communication at the scene of an accident - do not cut off the call until given permission to do so.

■ Certification information (SAR)

THIS DEVICE MEETS INTERNATIONAL GUIDELINES FOR EXPOSURE TO RADIO WAVES

Your mobile device is a radio transmitter and receiver. It is designed and manufactured not to exceed the limits for exposure to radio frequency (RF) recommended by international guidelines (ICNIRP). These limits are part of comprehensive guidelines and establish permitted levels of RF energy for the general population. The guidelines were developed by independent scientific organisations through periodic and thorough evaluation of scientific studies. The guidelines include a substantial safety margin designed to assure the safety of all persons, regardless of age and health.

The exposure standard for mobile devices employs a unit of measurement known as the Specific Absorption Rate, or SAR. The SAR limit stated in the international guidelines is 2.0

W/kg*. Tests for SAR are conducted using standard operating positions with the device transmitting at its highest certified power level in all tested frequency bands. Although the SAR is determined at the highest certified power level, the actual SAR of the device while operating can be well below the maximum value. This is because the device is designed to operate at multiple power levels so as to use only the power required to reach the network. In general, the closer you are to a base station, the lower the power output of the device.

The highest SAR value for this device when tested for use at the ear is 0.73 W/kg.

This device meets RF exposure guidelines when used either in the normal use position against the ear or when positioned at least 1.5 cm away from the body. When a carry case, belt clip or holder is used for body-worn operation, it should not contain metal and should position the product at least 1.5 cm away from your body.

In order to transmit data files or messages, this device requires a quality connection to the network. In some cases, transmission of data files or messages may be delayed until such a connection is available. Ensure the above separation distance instructions are followed until the transmission is completed.

* The SAR limit for mobile devices used by the public is 2.0 watts/kilogram (W/kg) averaged over ten grams of body tissue. The guidelines incorporate a substantial margin of safety to give additional protection for the public and to account for any variations in measurements. SAR values may vary depending on national reporting requirements and the network band. For SAR information in other regions please look under product information at www.nokia.com.

Index

A

- access codes 11, 50
- accessories 6, 7
 - battery 73
 - charger 7
- alarm clock 56
- allowed number when phone locked 50
- answering incoming call 18
- antenna 14, 79
- anykey answer 43
- applications 67
- Archive folder 28
- automatic answer 49
- automatic keyguard 45
- automatic service update 43

B

- background picture 47
- banner 48
- basic functions 17
- battery 13, 72
- bookmarks 63, 64

- browsing session 61
- browsing tips 63

C

- calculations 59
- calculator 58
- calendar 57
- calendar note 58
- call divert 52
- call register 34
- call restrictions 50
- call settings 43
- call timers 35
- call waiting 18, 52
- caller groups 37
- caller identity 52
- calling card 43
 - renaming 44
 - saving calling card information 44
- calls
 - answering 18
 - anykey answer 43

- automatic redial 43
- call waiting 52
- emergency call 83
- ending 17
- making calling cards calls 45
- rejecting 18
- restricting incoming calls 50
- restricting outgoing calls 50
- speed dialling 43
- using contacts list 17
- calorie counter 60
- care 79
- CDMA 8
- changing front and back cover 15
- character case 19
- charging the battery 13
- charging the glow-in-the-dark cover 16
- clock setting 47
- colour covers 78
- colour schemes 48
- compound words 21
- connectors 9
- contacts 36

D

- countdown timer 59
- currency conversion 59
- data/fax calls 35
- date setting 47
- deleting messages 32
- dialled numbers 35
- dialling a number using voice dialling 40
- digital clock 10
- display
 - background picture 47
 - brightness 48
 - colour schemes 48
 - contrast level 48
 - icons 10
 - indicators 10
 - settings 47
 - wallpaper 47
- distribution lists 29
- downloads 61, 68
- DTMF tones 46

E

- electronic devices 80
- e-mail 26

- emergency calls 83
 - enhancement settings 49
 - enter
 - numbers 19
 - punctuation 21
 - text 19
 - erase
 - mistakes 20
 - text 20
 - explosive atmospheres 82
- F**
- factory settings 53
 - feature code 53
 - financial information 61
 - flight times 61
 - folders 28
 - Archive 28
 - Inbox 28
 - My folders 28
 - Sent Items 28
 - functions 8, 17
- G**
- gallery 54
 - game settings 66
 - games 66
- Genuine Enhancements 75
 - glow-in-the-dark cover 16
 - Go to key 42
 - Go to menu 69
- H**
- handsfree 49
 - headset 49
 - hearing aids 81
 - help text activation 46
 - home network 51, 53
 - homepage 63
- I**
- icons 10
 - minibrowser 61
 - Inbox folder 28
 - incoming call 18
 - answering 18
 - rejecting 18
 - indicators 10
 - minibrowser 61
 - Internet 61
- J**
- Java applications 67

K

- keyguard 14, 45
- keypad lock 14
- keys 9

L

- language 45
- lap timing 60
- last number redialling 17
- launching a game 66
- launching an application 67
- launching minibrowser 62
- letter mode 19
- links 63
- loopset 49
- loudspeaker 19

M

- maintenance 79
- making a calendar note 58
- making a call 17
- making a currency conversion 59
- making an emergency call 84
- making calculations 59
- making calling cards calls 45
- medical devices 81
- memory

- applications 68
- contacts 37
- games 66

- memory full 32
- menu functions 23
- messages 26
 - deleting 32
 - multimedia messages 29
 - settings 32
 - text messages 26

MIDI 8

- minibrowser 35, 61
- minibrowser menu 62
- minibrowser messages 34, 65
- notification 65
- weblinks 65

- missed calls 35
- mistakes, erasing 20

MMS 29

- multimedia messages 29
- My folders 28
- my number selection 53

N

- network feature activation 53
- network services 6, 51

- news 61
- Nokia Application Installer 68, 70
- Nokia Connection Manager 71
- Nokia Content Copier 70
- Nokia Image Converter 70
- Nokia PC Suite 70
- Nokia PC Sync 70
- Nokia PC WAP Manager 70
- Nokia Phone Browser 71
- Nokia Phone Editor 70
- Nokia Sound Converter 70
- Nokia Web site 70
- number mode 19

O

- operating environment 80
- operating position 14
- options during a call 18
- organiser 56
- OTA 8
- outside of home network 51
- own number 37

P

- pacemakers 81
- PC Connectivity 70

- PC Suite 68
- personal short-cuts 42
- phone language 45
- phone lock 50
- phone settings 45
- phonebook (contacts) 36
- picture templates 28
- power key 14
- power saving 10
- predictive text input 20
- profiles 41

R

- reading and replying to a message or a SMS e-mail 27
- reading multimedia message 31
- received calls 35
- recent call lists 35
- recording 55
- redialling 17
- rejecting an incoming call 18
- replying multimedia message 31
- ringing tone 48
- ringing volume 48
- roaming 51

S

- safety 5
 - electronic devices 80
 - emergency call 83
 - explosive atmospheres 82
 - hearing aids 81
 - medical devices 81
 - operating environment 80
 - pacemakers 81
 - refuelling point (service station) 82
 - traffic 80
 - vehicles 82, 83
- saving calling card information 44
- security code 11, 50
- security settings 49
- selection key settings 42
- send my caller identity 52
- Sent Items folder 28
- service areas 53
- settings 42
 - multimedia messages 33
 - text and e-mail messages 32
- shared memory 7

shortcut

- searching for a name 37
- voice mailbox 34
- voice message 34
- SMS messages 26, 65
- speed dialling 17, 37, 43
- split timing 60
- standby mode 9
- stopwatch 60
- support 70
- switching the phone on 14

T

- templates 28
- terminating the minibrowser 62
- text 19
- text messages 26
- text phone (TTY/TTD) 49
- text templates 28
- time setting 47
- to-do list 58
- tone settings 48
- touch tones 46
- traditional text input 19, 21
- traffic safety 80
- TTY/TTD (text phone) 49

U

- UIM card 13
- URL address 63
- Use Web link 65
- using the menu 23

V

- vehicles 82
- vibrating alert 48
- voice 54
- voice commands 55
- voice dialling 39
- voice mailbox 34
- voice messages 34
- voice privacy 51
- voice recorder 55
- voice tags 54

- voice tags in contacts 37

W

- wallpaper 47
- weather reports 61
- web access 61
- weblinks 65
- welcome note 46
- writing and sending SMS or e-mail messages 26
- writing compound words 21
- writing text 19

X

- Xpress-on colour covers 78