

Service Schematics

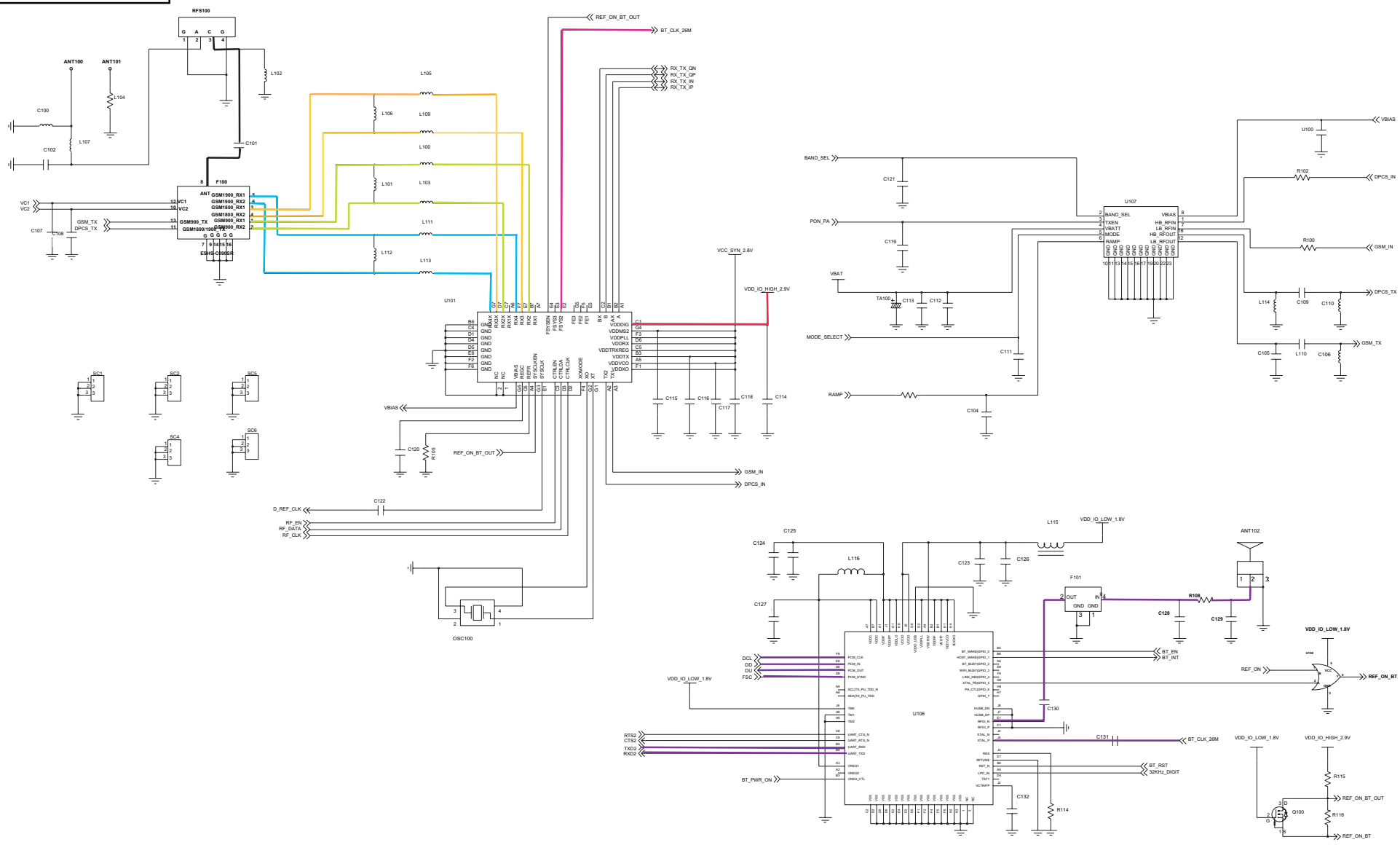

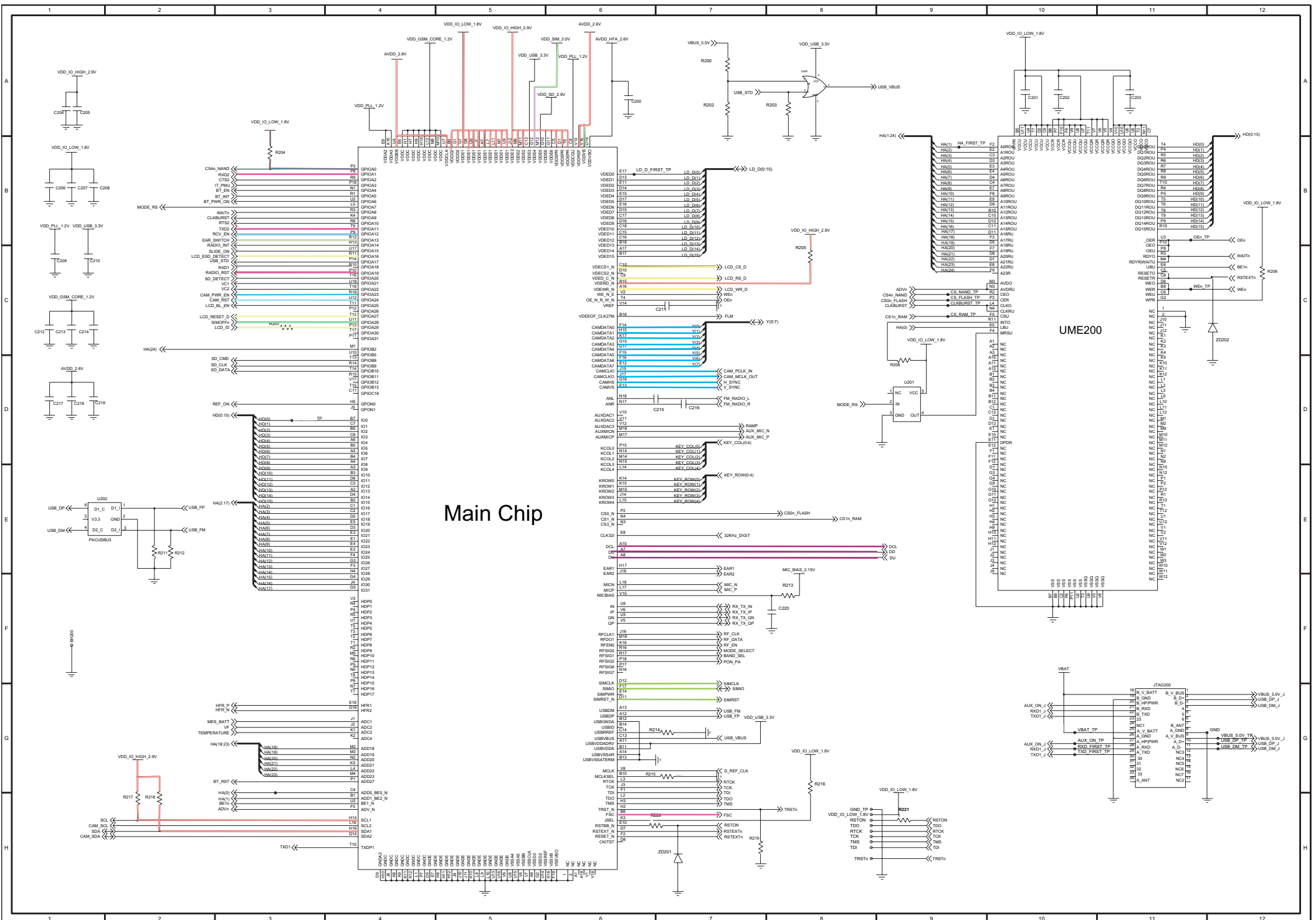

Main Chip

UME200

VBAT

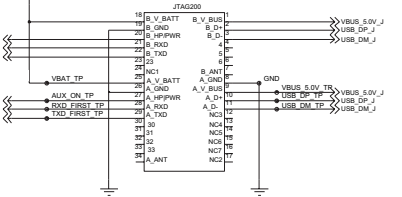

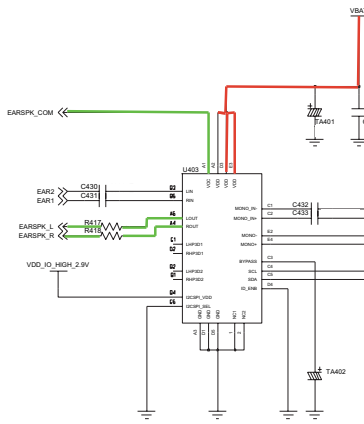
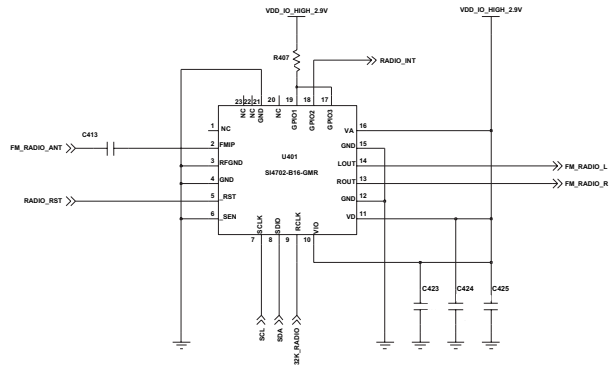
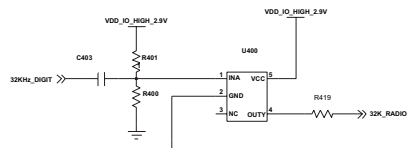

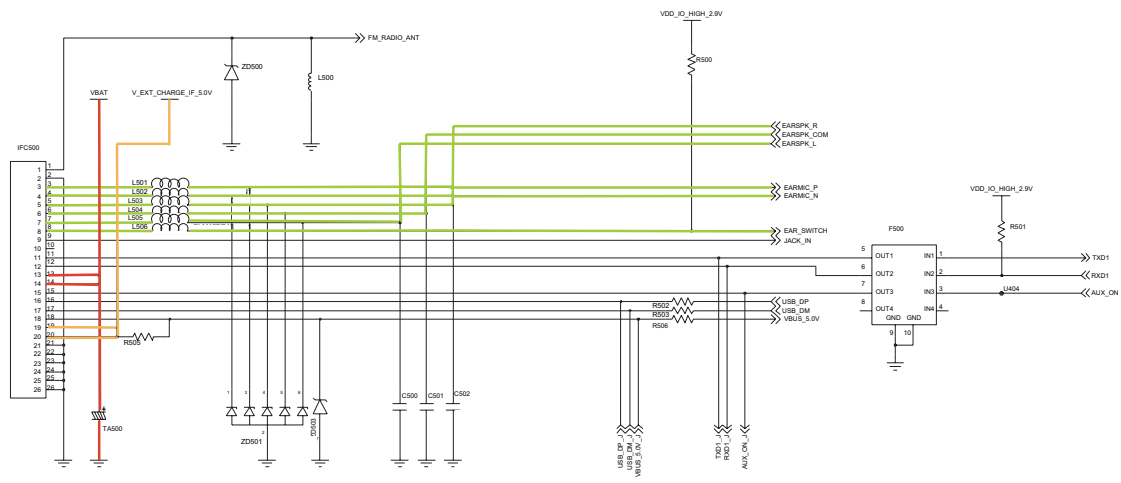

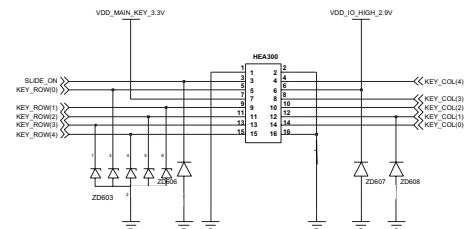
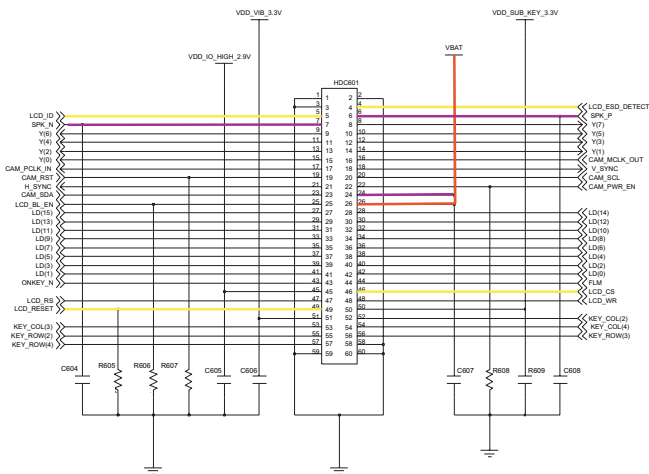
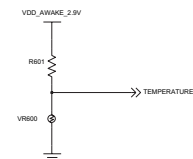
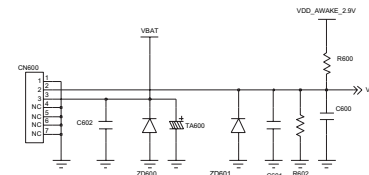
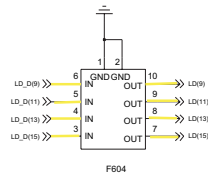
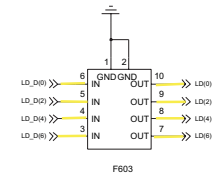
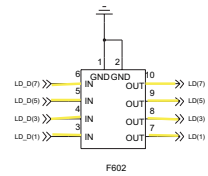
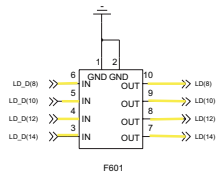
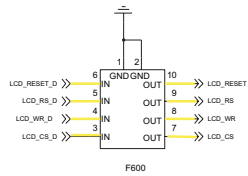

- Main bottom view

