

# KYOCERA Brio

## User Guide



©2011 Sprint. SPRINT and the logo are trademarks of Sprint. KYOCERA is a registered trademark of Kyocera Corporation. Other marks are the property of their respective owners.

# Table of Contents

---

Get Started .....	1
Your Phone at a Glance .....	2
Set Up Your Phone.....	2
Activate Your Phone.....	3
Set Up Voicemail.....	4
Sprint Account Information and Help .....	4
Sprint Account Password .....	5
Manage Your Account.....	5
Sprint Support Services .....	6
Phone Basics .....	7
Your Phone's Layout .....	8
Key Functions .....	8
Keyguard .....	10
Display Screen .....	10
Turn Your Phone On and Off.....	14
Battery and Charger .....	14
Navigate Through the Menus .....	15
Display Your Phone Number .....	16
Enter Text.....	16
Enter Text With the QWERTY Keyboard.....	17
Select a Text Input Mode .....	18
XT9 Smart Input.....	18
ABC Mode .....	19
Set Text Entry Options .....	19
Simple Data Exchange .....	20
Phone Calls & Settings .....	22
Make and Answer Phone Calls.....	22
Make Phone Calls.....	22
Dialing Options .....	23
Answer Phone Calls.....	23

Missed Call Notification.....	24
Call Emergency Numbers .....	24
In-Call Options .....	25
End-of-Call Options.....	26
Save a Phone Number.....	26
Find a Phone Number.....	26
Dial and Save Phone Numbers With Pauses .....	27
Dial From the Contacts List.....	27
Plus (+) Code Dialing .....	28
Speed Dialing .....	28
Abbreviated Dialing.....	28
Voicemail.....	29
Set Up Voicemail .....	29
Voicemail Notification.....	29
New Voicemail Message Alerts.....	30
Retrieve Your Voicemail Messages.....	30
Phone Call Options.....	31
Caller ID.....	31
Call Waiting.....	31
3-Way Calling .....	32
Call Forwarding.....	32
Phone Call Settings.....	32
Alert Notification.....	33
Call Answer Mode.....	33
Auto-Answer Mode .....	33
Headset Mode .....	33
Airplane Mode.....	34
TTY Use With Sprint Service.....	34
Use the Hearing Aid Device Compatibility Function .....	35
Settings.....	36
Display Settings.....	36
Change the Screen Saver.....	36
Change the Brightness.....	37

Change the Backlight Settings .....	37
Set the Notification Pop-up .....	37
Select a Picture ID .....	37
Power Save Mode.....	38
Change the Clock/Calendar Display.....	38
Set a Custom Greeting.....	38
Change the Phone's Menu Style.....	38
Change the Font Size .....	38
Display Language .....	39
Volume Settings .....	39
Adjust the Phone's Volume Settings .....	39
Silence All .....	39
Ringer Settings.....	40
Select Ringer Types for Incoming Calls .....	40
Select Ringer Types for Messages.....	40
Select Ringer Types for Voicemail, Calendar, and Power Up/Down.....	41
Get New Ringers.....	41
Set Up Voice Guide .....	41
Select a Vibration Pattern .....	42
Messaging Settings .....	42
Set Clear Alerts Icon .....	42
Set a Callback Number .....	42
Add a Customized Signature.....	43
Manage Preset Messages .....	43
Set Repeated Tone.....	44
Set Long Message Reassembly.....	44
Roaming.....	44
Roaming Icon.....	44
Roaming on Other Networks.....	45
Check for Voicemail Messages While Roaming .....	45
Set Roaming Mode .....	45
Enable Roaming .....	45
Roaming Guards.....	46

Security Settings .....	46
Lock Your Phone .....	47
Parental Controls .....	48
Delete Phone Content.....	49
Reset Your Phone and Phone Content .....	50
Security Features for Data Services.....	50
History .....	52
View History .....	52
Recent History List.....	52
History Icons .....	53
History Thread.....	53
History Details .....	53
History Options.....	53
Make a Call From History .....	54
Save a Number From History .....	54
Make a New Group Entry From History .....	54
Delete History.....	55
Contacts.....	56
Display Contacts Entries .....	56
Add a New Contacts Entry.....	57
Edit a Contacts Entry.....	57
Add a Number to a Contacts Entry .....	58
Create a Group.....	58
Edit Groups .....	58
Change the Group Name or Group Icon .....	59
Add Members to a Group.....	59
Remove Members From a Group.....	59
Delete a Contacts Entry or Group .....	59
Find Contacts Entries .....	60
Use Contacts Information in Other Applications.....	60
Assign Speed Dial Numbers.....	61
Select a Ringer Type for an Entry.....	61
Assign a Picture to an Entry .....	62

Secret Contacts Entries .....	62
Dial Sprint Services .....	63
Messaging .....	64
Text Messaging and Multimedia Messaging .....	64
Compose Messages .....	64
Access Messages .....	65
Threaded Messaging .....	65
Email .....	67
Get Started With Email.....	67
Access Email .....	68
Calendar & Tools .....	70
Calendar.....	70
Add an Event to the Calendar .....	70
Add a To Do List Item to the Calendar .....	71
Calendar Alerts .....	72
View Events .....	72
Delete Events .....	72
microSD Card.....	73
Insert a microSD Card.....	74
Remove the microSD Card .....	75
Create Folders in the microSD Card .....	75
View Memory in the microSD Card .....	76
Format the microSD Card .....	76
Back Up Your Contacts Data to the microSD Card .....	76
Display Your microSD Card Folders.....	76
File Manager.....	77
Digital Print Order Format (DPOF) .....	78
Connect Your Phone to Your Computer .....	79
Voice Services.....	80
Automatic Speech Recognition (ASR).....	80
Manage Voice Memos .....	83
Alarm.....	85
Calculator .....	86

World Clock.....	86
Countdown Timer.....	87
Stopwatch.....	87
Camera.....	88
Take Pictures.....	88
Take a Picture.....	88
Assign Pictures.....	89
Camera Mode Options.....	89
Camera Settings.....	91
Store Pictures.....	91
Storage Options.....	92
In Phone Folder.....	92
On Memory Card Folder.....	92
In Phone and On Memory Card Folder Options.....	92
Review Pictures in Assigned Media Folder.....	93
Send Pictures From Your Phone.....	93
Send Pictures Using the Messaging Feature.....	93
Send Pictures Using the Bluetooth Feature.....	94
Print Pictures From Your Phone.....	94
Bluetooth.....	96
Turn Bluetooth On and Off.....	96
Make Your Phone Discoverable.....	96
Bluetooth Menu.....	97
Pair Bluetooth Devices.....	97
Trusted Devices List.....	98
View the Trusted Devices List.....	98
Trusted Devices List Menu.....	98
Send Items via Bluetooth.....	99
Print Pictures via Bluetooth.....	99
Web and Data Services.....	101
Get Started With Data Services.....	101
Your User Name.....	101
Launch a Web Connection.....	102

Data Connection Status and Indicators .....	102
Learn to Navigate the Web .....	102
Download Games, Ringers, and More .....	104
Browser Menu .....	106
GPS Features .....	110
Location Mode.....	110
Sprint Family Locator.....	110
Sign Up for Sprint Family Locator .....	111
Use Sprint Family Locator .....	111
Copyrights.....	112
Index.....	113



# *Get Started*

---

This section gives you all the information you need to set up your phone and Sprint service the first time.

[Your Phone at a Glance](#)

[Set Up Your Phone](#)

[Activate Your Phone](#)

[Set Up Voicemail](#)

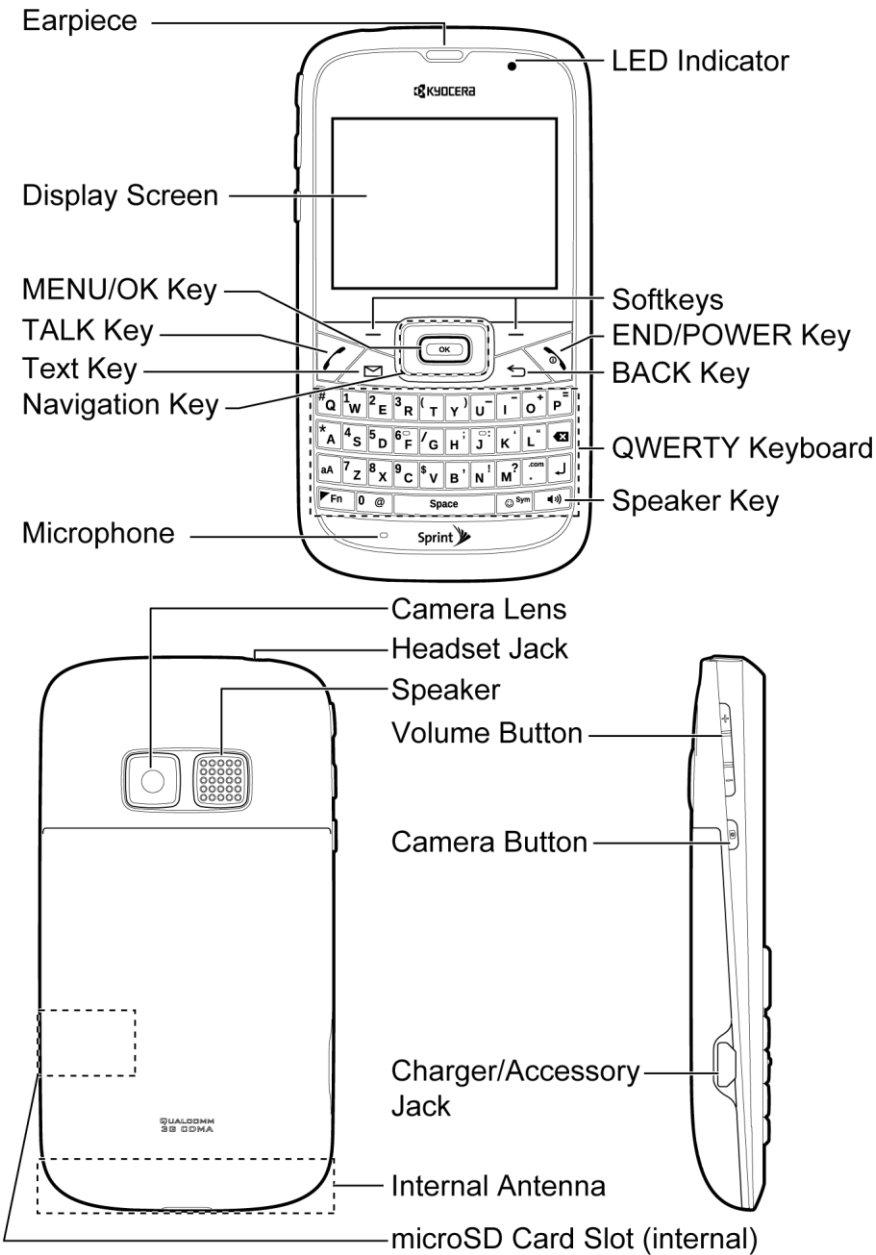

[Sprint Account Information and Help](#)

# Your Phone at a Glance





## Set Up Your Phone

1. Install the battery.
  - Insert the battery into the battery compartment, making sure the connectors align (1). Gently press down to secure the battery (2).

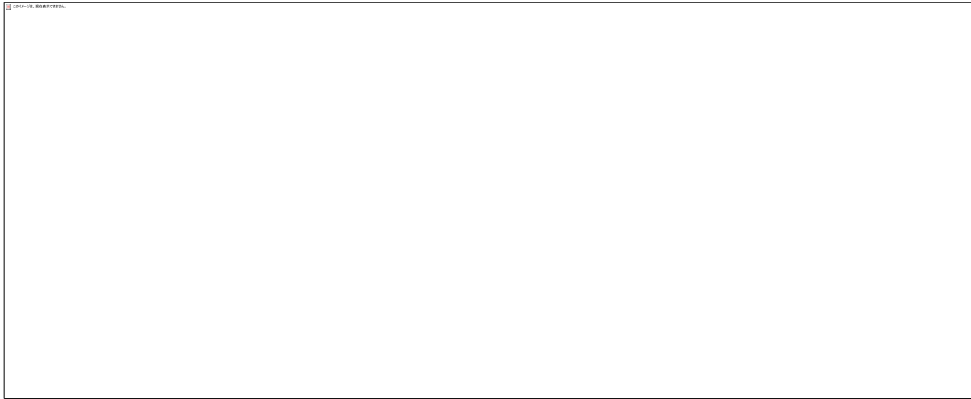
- Align the tabs of the battery cover with the slots  and press the battery cover down until it snaps into place .



2. Press and hold  to turn the phone on.
  - If your phone is activated, it will search for Sprint service and enter standby mode.
  - If your phone is not yet activated, see [Activate Your Phone](#) for more information.
3. Make your first call.
  - Use your keyboard to enter a phone number.
  - Press .

**Note:** Your phone's battery should have enough charge for your phone to turn on and find a signal, set up your voicemail, and make a call. You should fully charge your battery as soon as possible. See [Charge the Battery](#).

## Activate Your Phone

Depending on your account or how and where you purchased your phone, it may be ready to use or you may need to activate it on your Sprint account.

- If you purchased your phone at a Sprint Store, it is probably activated and ready to use.
- If you received your phone in the mail and it is for a new Sprint account or a new line of service, it is designed to activate automatically. To confirm your activation, make a phone call.
- If you received your phone in the mail and it is going to be activated on an existing number on your account (you're swapping phones), you can activate on your computer online or directly on your phone.
  - **Activate on your computer:**
    - Go to [sprint.com/activate](http://sprint.com/activate) and follow the instructions.

- **Activate on your phone:**

- Turn on your new phone. (Make sure the old one is turned off.) Your phone will automatically attempt Hands-Free Activation.
- Press **ACTIVATE** (left softkey) to override auto-activation and start the manual activation wizard.
- Follow the onscreen prompts to complete the activation process.
- To confirm activation, make a phone call. If your phone is still not activated or you do not have access to the Internet, contact Sprint Customer Service at **1-888-211-4727** for assistance.

**Tip:** Do not press  while the phone is being activated. Pressing  cancels the activation process.

**Note:** If you are having any difficulty with activation, contact Sprint Customer Service by calling **1-888-211-4727** from any other phone.

## Set Up Voicemail

Your phone automatically transfers all unanswered calls to your voicemail, even if your phone is in use or turned off. You should set up your Sprint Voicemail and personal greeting as soon as your phone is activated. Always use a password to protect against unauthorized access.

1. From standby mode, press and hold  to dial your voicemail number.
2. Follow the system prompts to:
  - Create your password.
  - Record your name announcement.
  - Record your greeting.

**Note: Voicemail Password** – Sprint strongly recommends that you create a password when setting up your voicemail to protect against unauthorized access. Without a password, anyone who has access to your phone is able to access your voicemail messages.

For more information about using your voicemail, see [Voicemail](#).

## Sprint Account Information and Help

Find out about account passwords and information about managing your account and finding help.

[Sprint Account Password](#)

[Manage Your Account](#)

[Sprint Support Services](#)

## *Sprint Account Password*

As a Sprint customer, you enjoy unlimited access to your personal account information, your voicemail account, and your data services account. To ensure that no one else has access to your information, you will need to create passwords to protect your privacy.

### *Account User Name and Password*

If you are the account owner, you will create an account user name and password when you sign on to [sprint.com](#). (Click **Sign in/Sign up** and then click **Sign up now!** to get started.) If you are not the account owner (if someone else receives the bill for your Sprint service), you can get a sub-account password at [sprint.com](#).

### *Voicemail Password*

You will create your voicemail password when you set up your voicemail. See [Set Up Voicemail](#) for more information on your voicemail password.

### *Data Services Password*

With your Sprint phone, you may elect to set up an optional data services password to control data (Web) access and authorize Premium Service purchases.

For more information, or to change your passwords, sign on to [sprint.com](#) or call Sprint Customer Service at **1-888-211-4727**.

## *Manage Your Account*



Manage your Sprint account from your computer, your Sprint phone, or any other phone.

**Online:** [sprint.com](#)

- Access your account information.
- Check your minutes used (depending on your Sprint service plan).
- View and pay your bill.
- Enroll in Sprint online billing and automatic payment.
- Purchase accessories.
- Shop for the latest Sprint phones.
- View available Sprint service plans and options.

- Learn more about data services and other products like games, ringers, screen savers, and more.

### From Your Sprint Phone

- Press **\* A 4 S**  to check minute usage and account balance.
- Press **\* A 3 R**  to make a payment.
- Press **\* A 2 E**  to access a summary of your Sprint service plan or get answers to other questions.

### From Any Other Phone

- Sprint Customer Service: **1-888-211-4727**.
- Business Customer Service: **1-888-788-4727**.

## *Sprint Support Services*

### *Sprint 411*

Sprint 411 gives you access to a variety of services and information, including residential, business, and government listings; movie listings or showtimes; driving directions, restaurant reservations, and major local event information. You can get up to three pieces of information per call, and the operator can automatically connect your call at no additional charge.

There is a per-call charge to use Sprint 411, and you will be billed for airtime.

- ▶ Press **4 S 1 W 1 W** .

### *Sprint Operator Services*

Sprint Operator Services provides assistance when placing collect calls or when you place calls billed to a local telephone calling card or third party.

- ▶ Press **0 @** .

For more information or to see the latest in products and services, visit us online at [sprint.com](http://sprint.com).

# Phone Basics

---

Your phone is packed with features that simplify your life and expand your ability to stay connected to the people and information that are important to you. The topics in this section will introduce the basic functions and features of your phone.

**Tip: Phone Software Upgrades** – Updates to your phone’s software may become available from time to time. Sprint will automatically upload critical updates to your phone. You can also use the menu to check for and download updates. Press  > **Tools > Update Phone > Update Firmware** to search for and download available updates.

Your Phone’s Layout

Display Screen

Turn Your Phone On and Off

Battery and Charger

Navigate Through the Menus

Display Your Phone Number

Enter Text

Simple Data Exchange

# Your Phone's Layout

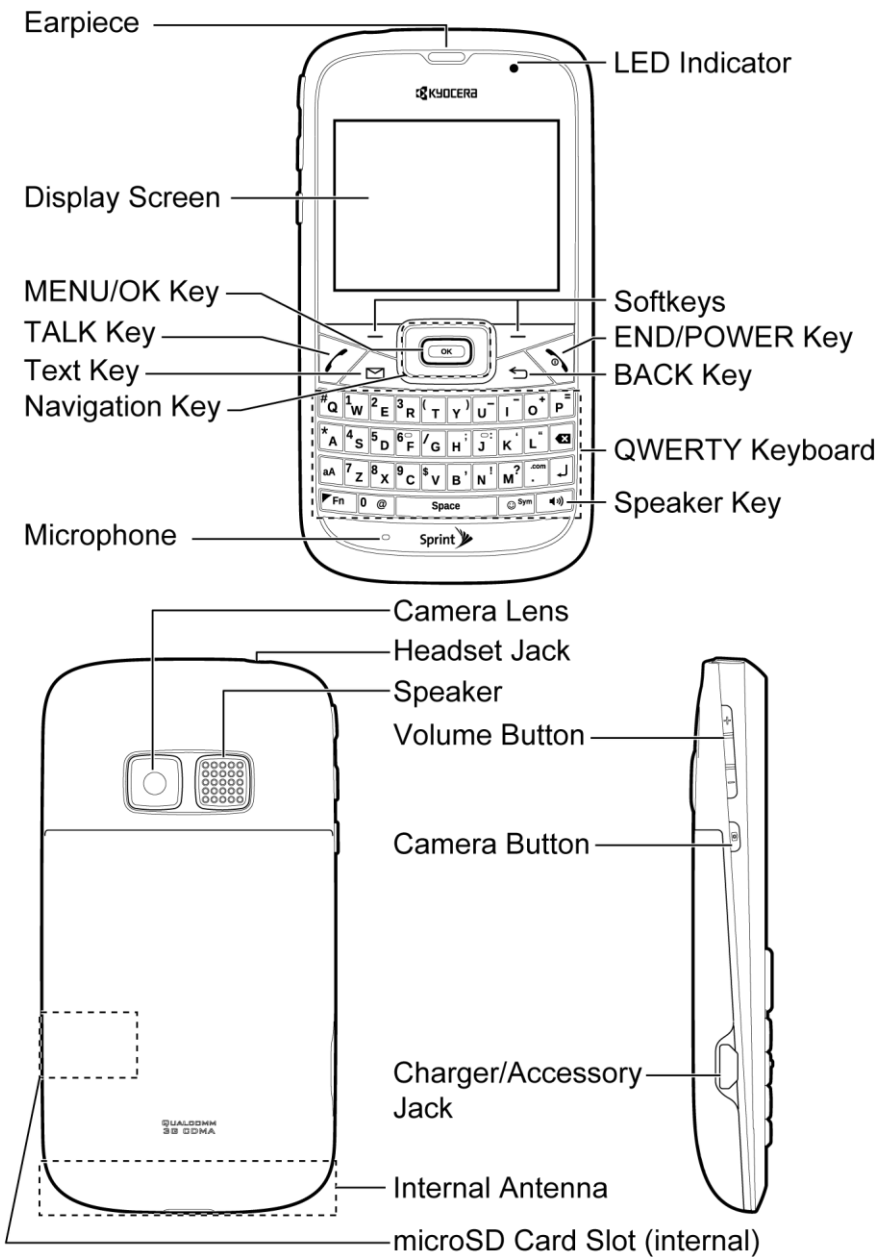

## Key Functions

### Keyguard

### Key Functions

- **Earpiece** lets you hear the caller and automated prompts.



- **Display Screen** displays all the information needed to operate your phone, such as the call status, the Contacts list, the date and time, and the signal and battery strength.
- **MENU/OK Key** lets you access the phone's menus and select the highlighted choice when navigating through a menu.
- **TALK Key** allows you to place or receive calls, answer Call Waiting, use 3-Way Calling, or activate Automatic Speech Recognition (ASR).
- **Text Key** provides one-touch access to the phone's messaging feature.
- **Navigation Key** lets you scroll through the phone's menu options.
- **Microphone** allows other callers to hear you clearly when you are speaking to them.
- **Speaker Key** lets you place or receive calls, activate ASR in speakerphone mode, and turn the speakerphone on or off during a call.
- **QWERTY Keyboard** lets you enter numbers, letters, and characters, and perform functions using single or combined keypresses.
- **BACK Key** deletes characters from the display in text input mode. When in a menu, pressing it returns you to the previous menu. This key also allows you to return to the previous screen in a data session.
- **END/POWER Key** lets you turn the phone on or off, end a call, or cancel your input and return to standby mode.
- **Softkeys** let you select softkey actions or menu items corresponding to the bottom left and right lines on the display screen.
- **LED Indicator** shows your phone's status at a glance.
- **Camera Lens**, as part of the built-in camera, lets you take pictures.
- **Headset Jack** allows you to plug in an optional headset for convenient, hands-free conversations.

**CAUTION!** Inserting an accessory into the incorrect jack may damage the phone.

- **Speaker** lets you hear the different ringers and sounds. The speaker also lets you hear the caller's voice in speakerphone mode.
- **Volume Button** allows you to adjust the ringer volume whenever your phone is turned on or adjust the voice volume during a call.
- **Camera Button** lets you access the Photos menu. Press and hold to activate the camera mode and take pictures.

- **Charger/Accessory Jack** allows you to connect a compatible charging cable or USB data cable (not included).

**CAUTION!** Inserting an accessory into the incorrect jack may damage the phone.

- **Internal Antenna** facilitates reception and transmission. To maximize performance, do not touch the bottom portion of your phone where the internal antenna is located while using the phone.
- **microSD Card Slot (internal)** lets you use a microSD™ or microSDHC™ memory card (both not included) to expand the memory of your phone. To gain access to the microSD card slot, you must first remove the battery cover. (See [microSD Card](#).)

## Keyguard

This feature enables you to lock side buttons and the QWERTY keyboard to avoid accidentally pressing a key or a button. You can place an emergency 911 call even if keys are locked.

To lock keys from standby mode:

- ▶ Press and hold .

To unlock keys:

- ▶ Press , and then press .

Keys will be temporarily unlocked when you:

- Receive a call. Press  to answer.
- Receive messages, scheduled events, alarms, or countdown notifications.

**Note:** If you do not operate your phone when you receive a call or notification, keys will be locked again automatically.







This feature is turned on by default. If you want to turn it off, do the following:









- ▶ Press  > **Settings** > **Keyguard** > **Off**.



## Display Screen





The status bar at the top of your phone's display screen provides information about your phone's status and options. The following tables identify the symbols you'll see on your phone's display screen.



**Tip:** To view a list of your phone's icons and descriptions, from the main menu select **Settings** > **Phone Info** > **Icon Glossary**.

Service Icons	Description
	<b>Signal Strength</b> – Your phone’s current signal strength. (More bars = stronger signal.)
	<b>No Service</b> – Your phone cannot find a usable signal.
	<b>Roaming</b> – Your phone is “roaming” off the Nationwide Sprint Network.
	<b>Data Service Active</b> – Sprint 1xRTT data service is available. When active, the icon is animated.
	<b>Data Service Dormant</b> – Sprint 1xRTT data service is currently dormant.
	<b>Data Service Unavailable</b> – Sprint 1xRTT data service is currently unavailable.





Status Icons	Description
	<b>Battery</b> – Your phone’s current battery charge level. (The icon to the left shows the battery is fully charged.) The icon is animated while the battery is charging.
	<b>Location On</b> – Your phone’s location feature is on and available for location-based services such as GPS.
	<b>Location Off</b> – Your phone’s location feature is off. Your location is available only for 911.
	<b>Silence All</b> – Your phone’s sound is turned off.
	<b>Vibrate All</b> – Your phone’s sound is turned off but vibrate is turned on.
	<b>Ringer Off</b> – Your phone’s ringer is turned off.
	<b>1 Beep</b> – A beep sounds when you receive an incoming call, a message, etc.
	<b>1 Beep and Vibrate</b> – 1 Beep and vibrate are set.
	<b>Ringer and Vibrate</b> – The volume level is set to between 1 and 8 and vibrate is turned on.





Messaging and Alert Icons	Description
	<b>New Messages</b> – You have one or more new messages waiting.
	<b>New Voicemail Messages</b> – You have one or more new voicemail messages waiting.









	<b>New Email Messages</b> – You have one or more new email messages waiting.
	<b>New Urgent Messages</b> – You have one or more new urgent messages waiting.
	<b>Multiple Alerts</b> – You have different kinds of alerts waiting.
	<b>Urgent Multiple Alerts</b> – You have different kinds of alerts (including urgent messages) waiting.
	<b>Application Alerts</b> – You have alert messages from Java applications activated in the background.





<b>Bluetooth Icons</b>	<b>Description</b>
	<b>Visible</b> – Your phone is discoverable by (visible to) other Bluetooth devices.
	<b>Connected</b> – Your phone is connected to a Bluetooth device.
	<b>Enabled</b> – Your phone's Bluetooth feature is enabled.

**Tip:** The above icons will blink while your phone is communicating with a Bluetooth device.

<b>Voice Call Icons</b>	<b>Description</b>
	<b>Missed Call</b> – You have one or more missed voice calls.
	<b>Bluetooth Device</b> – A call is in progress using a Bluetooth device.
	<b>Headset</b> – A call is in progress using an optional wired headset.
	<b>Car Kit</b> – A call is in progress using an optional car kit device.

<b>Camera Icons</b>	<b>Description</b>
	<b>Beach/Snow Mode</b> – Indicates the picture mode is set to Beach/Snow.
	<b>Scenery Mode</b> – Indicates the picture mode is set to Scenery.
	<b>Mirror Image Mode</b> – Indicates the picture mode is set to Mirror Image.
	<b>Night/Dark Mode</b> – Indicates the picture mode is set to Night/Dark.

	<b>Self-Timer (5 Seconds)</b> – Indicates the self-timer is set to 5 seconds.
	<b>Self-Timer (10 Seconds)</b> – Indicates the self-timer is set to 10 seconds.
	<b>Multiple Shots</b> – Indicates the multiple shots function is enabled.
	<b>Camera Resolution (1.3M)</b> – Indicates the camera is set to 1.3-megapixel resolution (1280x960).
	<b>Camera Resolution (0.3M)</b> – Indicates the camera is set to 0.3-megapixel resolution (640x480).
	<b>Camera Resolution (0.1M)</b> – Indicates the camera is set to 0.1-megapixel resolution (320x240).
	<b>Saving to Phone</b> – Indicates your phone is saving a picture to the phone memory.
	<b>Saving to Memory Card</b> – Indicates your phone is saving a picture to the memory card.

Other Icons	Description
	<b>TTY</b> – Your phone is connected to a TTY device.
	<b>Alarm</b> – An alarm or countdown is set.
	<b>Calendar</b> – You have event notifications.
	<b>HAC Enabled</b> – Your phone's HAC (hearing aid compatibility) setting is enabled.
	<b>Multitasking Virtual Machine</b> – Indicates Java applications are running. The number next to the plus sign indicates the number of running applications.

# Turn Your Phone On and Off

## Turn Your Phone On

- ▶ Press and hold .

## Turn Your Phone Off

- ▶ Press and hold  for two seconds until you see the powering-down animation on the display screen.

Your screen remains blank while your phone is off (unless the battery is charging).

## Battery and Charger

**Warning:** Use only Sprint-approved or Kyocera-approved batteries and chargers with your phone. The failure to use a Sprint-approved or Kyocera-approved battery and charger may increase the risk that your phone will overheat, catch fire, or explode, resulting in serious bodily injury, death, or property damage.

Sprint-approved or Kyocera-approved batteries and accessories can be found at Sprint Stores or through Kyocera; or call 1-866-866-7509 to order. They're also available at [sprint.com](http://sprint.com).

### Battery Capacity

Your phone is equipped with a Lithium Ion (Li-Ion) battery. It allows you to recharge your battery before it is fully drained.

For a quick check of your battery level, glance at the battery charge indicator located in the upper right corner of your phone's display screen. When there are approximately five minutes of talk time left, the battery icon turns red () and the phone sounds a warning tone.

After an additional five minutes or so, the phone sounds a warning tone three times and then turns off.

**Note:** Long backlight settings, searching for service, vibrate mode, browser use, and other variables may reduce the battery's talk and standby times.

**Tip:** Watch your phone's battery level indicator and charge the battery before it runs out of power.

### Install the Battery

- ▶ See [Set Up Your Phone](#).

### Remove the Battery

1. Make sure the power is off so that you do not lose any stored numbers or messages.

2. Insert a flat object into the slot at the bottom of the battery compartment cover and lift the cover up gently.
3. Lift the battery up and remove it from the phone.

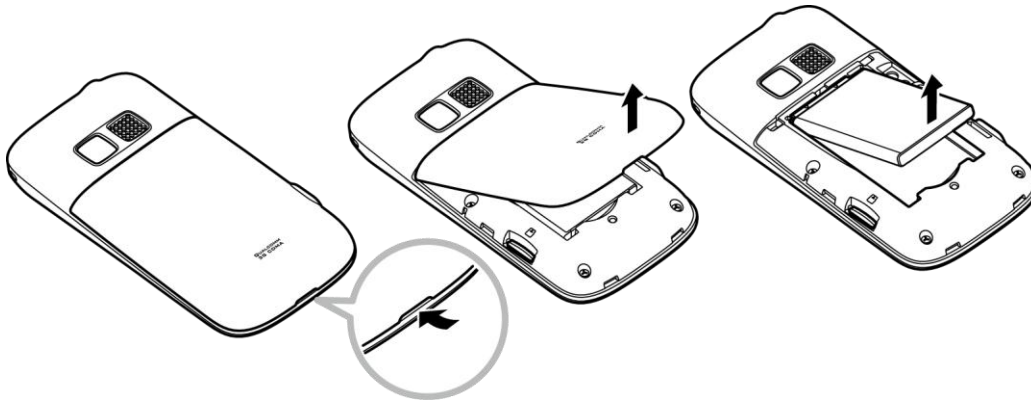

**Warning:** Do not handle a damaged or leaking Li-Ion battery as you can be burned.

### *Charge the Battery*

Keeping track of your battery's charge is important. If your battery level becomes too low, your phone automatically turns off, and you will lose any information you were just working on.

Always use a Sprint-approved or Kyocera-approved desktop charger, travel charger, or vehicle power adapter to charge your battery.

1. Plug the phone charger into an electrical outlet.
2. Plug the other end of the phone charger into the charger/accessory jack on the left side of your phone.

With the Sprint-approved Li-Ion battery, you can recharge the battery before it becomes completely run down.

## *Navigate Through the Menus*





The navigation key on your phone lets you scroll through onscreen items. To navigate through a menu, press the navigation key up or down.

Many menus feature a scroll bar on the right to help you keep track of your position in the menu.

### *Select Menu Items*

As you navigate through the menu, menu options are highlighted. Select any option by highlighting it and pressing . If the option is numbered, you can select it by pressing the corresponding number on the phone's keyboard.



For example, to view the Icon Glossary screen:

1. From standby mode, press  to access the main menu.
2. Select **Settings** by highlighting it and pressing .
3. Select **Phone Info** by highlighting it and pressing .
4. Select **Icon Glossary** by highlighting it and pressing .

For the purposes of this guide, the above steps condense into:



- ▶ Press  > **Settings** > **Phone Info** > **Icon Glossary**.

### *Back Up Within a Menu*

- ▶ Press  to go to the previous menu.
- ▶ Press  to return to standby mode.

### *Navigation Key Shortcuts*

You can use the navigation key to access shortcuts to specific menu items directly from standby mode. You can reassign the default shortcuts to the menu items you choose.

1. Press  > **Settings** > **Others** > **Navigation Keys**.
2. Highlight a navigation key direction you wish to reassign and press .
3. Using the navigation key or your keyboard, highlight a function.
4. Press **ASSIGN** (left softkey) to save. (For options with submenu levels, such as Settings, you can assign submenu options by navigating to the desired option before pressing **ASSIGN**.)

## *Display Your Phone Number*

- ▶ Press  > **Settings** > **Phone Info** > **Phone#/User ID**.

Your phone number and other information about your phone and account will be displayed.

## *Enter Text*

You can enter text on your phone using the QWERTY keyboard.

[Enter Text With the QWERTY Keyboard](#)

[Select a Text Input Mode](#)

[XT9 Smart Input](#)



## ABC Mode

### Set Text Entry Options

## Enter Text With the QWERTY Keyboard

Your phone features a QWERTY keyboard, specifically designed for easy and comfortable text entry. The QWERTY keyboard works in the same way as the standard keyboard on any computer. The easiest way to enter text on the QWERTY keyboard is to use your thumbs.

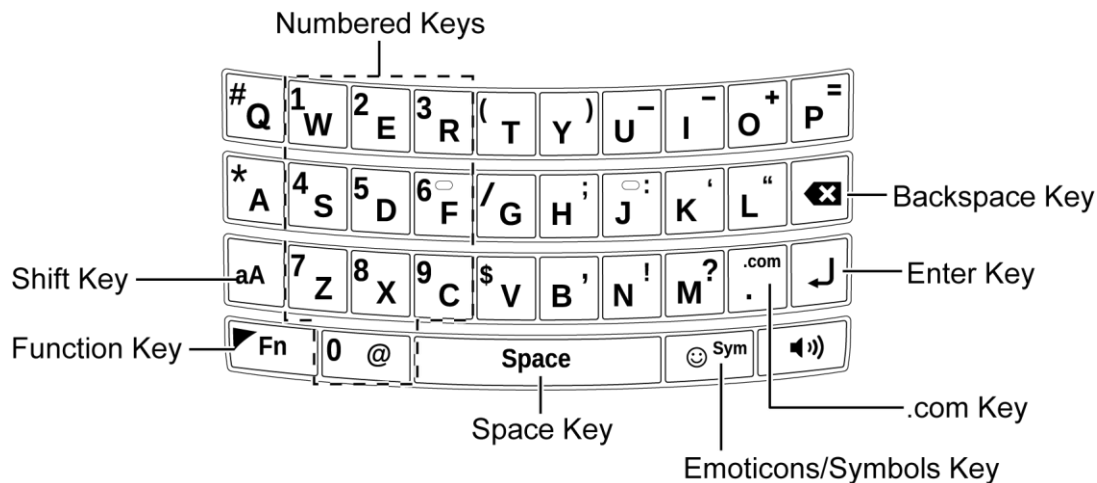

You can do the following with the QWERTY keyboard:

Key	Function
	<b>Shift:</b> Use to toggle uppercase and lowercase text input. Change the capitalization style (Abc > ABC > abc or XT9Word > XT9WORD > XT9word).
	<b>Function:</b> Use to enter the number or symbol labeled on the top of the QWERTY keys (for example #, *, /, +, !). Press this key first and then any corresponding key. To continue entering the labeled numbers or symbols, keep pressing and holding this key while you press corresponding keys. To lock the function key, press twice. After a function key is pressed, <b>Fn</b> is displayed at the lower right corner of the screen. (The key lock icon <b>Fn</b> appears when locked.)
	<b>Space:</b> Use to insert a space between letters, words, and sentences.
	<b>Emoticons/Symbols:</b> Use to open the Emoticons and Smileys or Symbols window. Press this key to open and switch between the Emoticons and Smileys window. Press  and then press this key to open the Symbols window. Highlight the emoticon, smiley, or symbol you want, and then press  to insert it into your text.
	<b>.com:</b> Use to insert a dot. Press  and then press this key to insert .com.
	<b>Enter:</b> Use to create a new line of text.
	<b>Backspace:</b> Use to delete a character. Press and hold this key to delete an entire word.

## Select a Text Input Mode

Your phone provides convenient ways to enter letters, numbers, and symbols whenever you are prompted to enter text.

1. From a screen where you can enter text, press **OPTIONS** (right softkey) to change the text mode. (If you are in the message entry screen, press **OPTIONS** [right softkey] > **Text Mode**.)
2. Select one of the following options:
  - **Abc** to enter characters using the alphabet mode. (See [ABC Mode](#).)
  - **XT9Word** to enter text using a predictive text system that reduces the number of keypresses required while entering a word.
  - **Symbols** to enter symbols.
  - **Smileys** to enter smile icons.
  - **Emoticons** to enter “emoticons.” (This is available, for example, when composing a message or when editing a Schedule or To Do description in Calendar.)
  - **Paste List** to paste copied or cut text (if applicable).
  - **Web Shortcuts** to enter Web shortcuts (for example, www., http://, or .com).
  - **Text Options** to display the text entry options menu (if applicable). (See [Set Text Entry Options](#).)



**Tip:** When entering text, press  to change the capitalization style as Abc > ABC > abc (Abc mode), or as XT9Word > XT9WORD > XT9word (XT9Word mode). The selected style is displayed in the bottom-right corner of the screen, above the right softkey label (if applicable).

## XT9 Smart Input

XT9 Smart Input helps eliminate errors caused by keypress errors when using a small QWERTY keyboard. (To select the **XT9Word** mode when entering text, see [Select a Text Input Mode](#).)

XT9 Smart Input uses a predictive word database to provide a selection list that enables word prediction and word completion, and features like smart punctuation and auto accenting to analyze the letters you enter and create a suitable word. (The word may change as you type.)

1. Select the **XT9Word** text input mode.

2. When you enter letters, a word choice list opens and shows words starting with the letters you have entered thus far. (If you make a mistake, press  to erase a single character. Press and hold  to erase an entire word.)
3. Scroll to the correct word and press  to select it.

### *Add a Word to the XT9 Database*

If a word you want to enter is not displayed in an XT9 word choice list when you are using XT9 Smart Input, add it to the database.

1. While you are in **XT9Word** mode, enter a letter. (A word choice list opens.)
2. Scroll down the list and select **<Add Word>**.
3. Enter a word and press **SAVE** (left softkey). The word will appear as an option the next time you scroll through options during XT9 Smart Input.

For more information about XT9 Smart Input, visit the Nuance website at [nuance.com/for-business/by-product/xt9/index.htm](http://nuance.com/for-business/by-product/xt9/index.htm).

### *ABC Mode*

In **Abc** mode, you can enter alphabetic characters associated with each key.

1. Select the **Abc** text input mode. (See [Select a Text Input Mode](#).)
2. Press the corresponding alphabet keys to enter the word.

By default, the first letter of a sentence is capitalized and the following letters are lowercased. To switch between lowercase and uppercase, press the  key.

### *Set Text Entry Options*

The text entry options menu allows you to specify a suitable feature during the text entry process.

1. When entering text, press **OPTIONS** (right softkey) > **Text Options**.

- or -

From standby mode, press  > **Settings** > **Text Entry**.

2. Highlight an option and press .
  - **Word Complete** to suggest possible words based on letters you have entered when you are using XT9 Smart Input. (See [XT9 Smart Input](#).)

- **Next Word Complete** to automatically display the word that may follow the current text input.
- **Phrase Complete** to set the phone to predict possible phrases after one word with a space is entered.
- **Word Scan** to allow the predictive text input system to suggest words by searching Contacts.
- **Word Choice List** to select whether to display or hide the word choice list.
- **Input Language** to select the language to enter (English or Spanish).
- **My Words** to edit or delete custom words you have added to the predictive text database.
  - **Add Word** to store words that you frequently use.
- **Auto Substitution** to replace abbreviated words or phrases with full-text equivalents that are added by you.
- **Select Text** to select text for copying, cutting or adding (if applicable).
- **Delete All** to delete all text (if applicable).
- **Help** to view the XT9 instructions.

## *Simple Data Exchange*

This feature makes it easy to select certain information in a message or email message and automatically save it or use it in a related application.

Simple Data Exchange works with these types of information:

- Email addresses
- Street addresses
- Phone numbers
- Web addresses (URLs)

### *Email Address Options*

- ▶ Highlight an email address (or a saved Contacts entry name in the From/To field in the message details screen), press , and then select an option:
  - **Send Message > Message** or **Email**. The selected messaging application will open and the email address will appear as the message's recipient.

- **Share > Message** or **Email**. The selected messaging application will open and the email address will appear in the message body.
- **Save to Contacts** to save the email address in Contacts.
- **Contact Details** to display the Contacts entry if the email address is already saved in Contacts.

### *Street Address Options*

- ▶ Highlight a street address, press , and select an option:
  - **Share > Message** or **Email**. The selected messaging application will open and the address will appear in the message body.
  - **Save to Contacts** to save the address in Contacts.

### *Phone Number Options*

- ▶ Highlight a phone number, press , and then select an option:
  - **Call** to call the phone number.
  - **Prepend** to prepend a number to the phone number.
  - **Send Message** to send a message to the phone number. The messaging application will open and the phone number will appear in the **To:** field.
  - **Share > Message** or **Email**. The selected messaging application will open and the phone number will appear in the message body.
  - **Save to Contacts** to save the phone number in Contacts.
  - **Contact Details** to display the Contacts entry if the phone number is already saved in Contacts.

### *Web Address (URL) Options*

- ▶ Highlight a Web address (URL), press , and select an option:
  - **Browse** to open the browser to the Web page.
  - **Share > Message** or **Email**. The selected messaging application will open and the Web address will appear in the message body.
  - **Save to Contacts** to save the Web address in Contacts.

# Phone Calls & Settings

---

With the Nationwide Sprint Network and your phone, you can enjoy clear calling across the country.

[Make and Answer Phone Calls](#)

[Voicemail](#)

[Phone Call Options](#)

[Phone Call Settings](#)

## *Make and Answer Phone Calls*

This topic will help you learn the basics of making and answering phone calls.

[Make Phone Calls](#)

[Dialing Options](#)

[Answer Phone Calls](#)

[Missed Call Notification](#)

[Call Emergency Numbers](#)

[In-Call Options](#)

[End-of-Call Options](#)

[Save a Phone Number](#)

[Find a Phone Number](#)

[Dial and Save Phone Numbers With Pauses](#)

[Dial From the Contacts List](#)



[Plus \(+\) Code Dialing](#)

[Speed Dialing](#)

[Abbreviated Dialing](#)

## *Make Phone Calls*

1. Enter a phone number from standby mode. (If you make a mistake while dialing, press  to erase the numbers.)



2. Press  or .
3. Press  when you are finished.

**Tip:** To redial your last outgoing call, press  twice.

You can also place calls from your phone by speed dialing (see [Speed Dialing](#)), by using Automatic Speech Recognition (see [Make a Voice Call Using ASR](#)), and by using your History listings (see [Make a Call From History](#)).

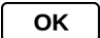
## Dialing Options

When you enter numbers in standby mode, you can see available dialing options by pressing **OPTIONS** (right softkey). To select an option, use the navigation key to highlight it and press .

- **Save** to save a phone number in your Contacts. (See [Save a Phone Number](#).)
- **Contact Details** to view the detailed information of a Contacts entry when the number you have entered is already saved in your Contacts.
-  **Hard Pause** to insert a hard pause. (See [Dial and Save Phone Numbers With Pauses](#).)
-  **2-Sec. Pause** to insert a two-second pause. (See [Dial and Save Phone Numbers With Pauses](#).)

**Tip:** When the left softkey displays **SEND MESSAGE**, press it to send a message.

## Answer Phone Calls



1. Make sure your phone is on. (If your phone is off, incoming calls go to voicemail.)
2. Press  to answer an incoming call. (Depending on your settings, you may also answer incoming calls by pressing other keys. See [Call Answer Mode](#).)

Your phone notifies you of incoming calls in the following ways:

- The phone rings or vibrates.
- The backlight illuminates.
- The screen displays an incoming call message.

If the incoming call is from a number stored in your Contacts, the entry's name is displayed. The caller's phone number may also be displayed, if available.



For other actions when receiving a call, you can select an onscreen menu or press a key:

- Press  to answer the call in speaker mode.
- **Answer** to answer the call.
- When connecting Bluetooth, select **Answer with <Bluetooth device name>** or **Answer with Phone** to answer a call with your selected device.
- **Silence** to mute the ringer and stop the vibration. Pressing  or the volume button has the same effect.
- **Send to Voicemail** to send the call to Voicemail.
- **Ignore with Text** to ignore the call and send a message to the caller.
- Press  to ignore the call.

**Note:** **Ignore with Text** may not be displayed when calls are from entries identified as **No Caller ID**, **Private** (Restricted ID), or **Unavailable ID**.

### *Answer a Roam Call With Roaming Guards Enabled*

Roaming Guards are options that help you manage your roaming charges when making or receiving calls while outside the Nationwide Sprint Network. Please see [Roaming](#) for more information about roaming.

- ▶ Press  and then press  to answer the call. (See [Roaming Guards](#) for additional information.)



### *End a Call*

- ▶ Press .







### *Missed Call Notification*

When an incoming call is not answered, your screen displays the Missed Call log. Press  to dial the phone number.

To display a Missed Alerts entry from standby mode:

1. Press  > **Missed Alerts**.
2. Highlight the entry you wish to view and press .

### *Call Emergency Numbers*

You can place calls to 911 (press       ) , even if your phone is locked or your account is restricted.





**Note:** After you have placed an emergency call, your phone automatically enters Emergency mode.

During an emergency call, press **OPTIONS** (right softkey) to display your options. Highlight an option and press .

- **Transfer Audio** to switch the call to an external device.
- **Contacts** to display the Contacts list.
- **Voice Memo** to record the other party's voice.
- **Phone Info** to display information about your phone.

**Tip:** Press **MY PHONE#** (left softkey) to display your phone number during an emergency call.

To exit Emergency mode:

1. Press  to end a 911 call.
2. Press  .

### *Enhanced 911 (E911) Information*

This phone features an embedded Global Positioning System (GPS) chip necessary for utilizing E911 emergency location services where available.

When you place an emergency 911 call, the GPS feature of your phone seeks information to calculate your approximate location. Depending on several variables, including availability and access to satellite signals, it may take up to 30 seconds or more to determine and report your approximate location.

**Important:** Always report your location to the 911 operator when placing an emergency call. Some designated emergency call takers, known as Public Safety Answering Points (PSAPs) may not be equipped to receive GPS location information from your phone.

### *In-Call Options*

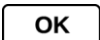
Pressing **OPTIONS** (right softkey) during a call displays a list of available in-call features. To select an option, highlight the option and press .

- **Transfer Audio** to switch the call to a Bluetooth device (if applicable).
- **Save** to save the current call's phone number in your Contacts.
- **Contact Details** to display information about the caller stored in your Contacts.
- **Main Menu** to display the phone's main menu.

- **3-Way Call** to open a call with two other parties.
- **Contacts** to display your Contacts list.
- **Voice Memo** to record the other party's voice.
- **Phone Info** to display information about your phone.
- ▶ Press **MUTE** or **UNMUTE** (left softkey) to mute or unmute the microphone.
- ▶ Press the volume button up or down to adjust the receiver volume.
- ▶ Press  to turn the speaker on. Press again to turn it off.

**Warning:** Because of higher volume levels, do not place the phone near your ear during speakerphone use.

## End-of-Call Options

After you have finished your call, the phone will display the caller's name (if already in your Contacts), phone number (if available), and the duration of the call.

- ▶ Press **OPTIONS** (right softkey) to display the Recent History options. (See [History Options](#).)

## Save a Phone Number

Your phone can store up to 600 Contacts entries and each entry can contain up to seven phone numbers. (See [Contacts](#).)

1. From standby mode, enter a phone number and press **OPTIONS** (right softkey) > **Save**. (If this is the first time you are saving an entry to Contacts, skip to step 3.)
2. Select **New Entry** or **Existing Entry**.
3. If you chose **New Entry**, select a number type, and then enter the new entry name.

- or -

If you chose **Existing Entry**, select an entry to which you want to save the number, and then highlight a number type and press .

4. Press **DONE** (left softkey) to save the entry.

## Find a Phone Number

You can search Contacts entries for phone numbers that contain a specific string of numbers.

1. Enter four or more digits of the number in standby mode. (The more numbers you enter, the more specific the search becomes.)

2. All Contacts entries matching the entered numbers will be displayed. Highlight an entry and press  to dial the number.

## *Dial and Save Phone Numbers With Pauses*

You can dial or save phone numbers with pauses for use with automated systems, such as voicemail or credit card billing numbers.

There are two types of pauses available on your phone:

- **Hard Pause** sends the next set of numbers when you press **SEND TONES** (left softkey).
- **2-Sec. Pause** automatically sends the next set of numbers after two seconds.

**Note:** You can have multiple pauses in a phone number and combine two-second and hard pauses.

To dial or save phone numbers with pauses:

1. Enter all or part of a number.
2. Press **OPTIONS** (right softkey) > **Hard Pause** or **2-Sec. Pause**.
3. Enter additional numbers.
4. Press  to dial the number.

- or -

Press **OPTIONS** (right softkey) > **Save**. (You can save to a new or existing contact entry.)

**Note:** When dialing a number with a hard pause, press **SEND TONES** (left softkey) to send the next set of numbers.

## *Dial From the Contacts List*



1. From standby mode, press **CONTACTS** (right softkey).

- or -

Press  > **Contacts**.

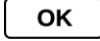

2. Select the entry you want to call.
3. Press  to dial the entry's default phone number.

- or -

To dial another number from the same entry, select the name and press , and then select a number and press .

## Plus (+) Code Dialing

When placing international calls, use Plus Code Dialing to automatically enter the international access code for your location (for example, 011 for international calls made from the U.S.).

1. Press  or press and hold  to display “+” on your phone screen.
2. Enter the country code and phone number, and then press . (The phone automatically prepends the access code for international dialing, followed by the country code and phone number.)

## Speed Dialing

You can store up to 98 numbers in your phone’s speed dial memory to make contacting friends and family easier.

You must have already assigned a speed dial number to an existing phone number. See [Assign Speed Dial Numbers](#).

To use speed dial for locations 2-9:

- ▶ From standby mode, press and hold the appropriate key for approximately two seconds.

To use speed dial for locations 10-99:

- ▶ From standby mode, enter a two-digit speed dial number, and then press .

The display confirms that the number has been dialed when it shows “Connecting...”.

## Abbreviated Dialing

Abbreviated Dialing is similar to speed dialing. You can use either of the following abbreviated dialing features.

- **Contacts Match** – Retrieve any number saved in your Contacts by entering four or more digits of any part of the number.
- **Prepend** – Prepend the first five or six digits (for example, the area code and prefix) to any four or five digits you enter.

To activate the Prepend feature:

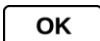
1. Press  > **Settings** > **Others** > **Call Setup** > **Abbreviated Dialing**.
2. Select **Prepend** > **On**.
3. Enter a five- or six-digit number and press .



To place a call using Abbreviated Dialing:

1. Enter the four or more digits of any part of a Contacts entry's phone number to use the Contacts Match feature.

- or -

Enter the last four or five digits of the number to use the Prepend feature.

**Note:** Contacts Match will not retrieve numbers if you enter 911 or reserved three-digit service numbers such as 411 or 711.

2. Press  to call the displayed number. If there are two or more matched numbers in your Contacts, a list is displayed. Highlight the name or the phone number you want to call, and then press  to place a call.

## *Voicemail*

Your phone automatically transfers all unanswered calls to your voicemail, even if your phone is in use or turned off. You should set up your Sprint Voicemail and personal greeting as soon as your phone is activated. Always use a password to protect against unauthorized access.

[Set Up Voicemail](#)

[Voicemail Notification](#)

[New Voicemail Message Alerts](#)

[Retrieve Your Voicemail Messages](#)

## *Set Up Voicemail*

1. From standby mode, press and hold  to dial your voicemail number.
2. Follow the system prompts to:
  - Create your password.
  - Record your name announcement.
  - Record your greeting.

**Important:** **Voicemail Password** – Sprint strongly recommends that you create a password when setting up your voicemail to protect against unauthorized access. Without a password, anyone who has access to your phone is able to access your voicemail messages.

## *Voicemail Notification*

There are several ways your phone alerts you to a new message:

- By displaying a message on the screen.
- By sounding the assigned ringer type.
- By displaying  at the top of the screen.

## *New Voicemail Message Alerts*

When you receive a new voicemail message, your phone alerts you and prompts you to call your voicemail.

To call your voicemail from the notification screen:

► Press .

**Note:** When you are roaming off the Nationwide Sprint Network, you may not receive notification of new voicemail messages. Sprint recommends that you periodically check your voicemail by dialing 1 + area code + your wireless phone number. When your voicemail answers, press  and enter your password. Roaming rates apply when you access voicemail while roaming off the Nationwide Sprint Network.

**Note:** Your phone accepts messages even when it is turned off. However, your phone notifies you of new messages only when it is turned on and you are in a Sprint service area.

## *Retrieve Your Voicemail Messages*

You can review your messages directly from your wireless phone or from any other touch-tone phone.

### *Use Voicemail to Access Your Messages*

1. Press and hold .

- or -

From standby mode, press **MESSAGING** (left softkey) > **Voicemail**.

2. Enter your voicemail password if prompted.
3. Follow the voice prompts to listen to and manage your voicemail messages.

**Note:** You are charged for airtime minutes when you are accessing your voicemail from your wireless phone.

### *Use Another Phone to Access Messages*

1. Dial your wireless phone number.
2. When your voicemail answers, press the asterisk key (\*) on the phone.

3. Enter your password.

**Tip:** When you call into voicemail, you first hear the header information (date, time, and sender information) for the message. To skip directly to the message, press **4 S** during the header.

## Phone Call Options

Your phone provides many useful features to help you make the most of your calling experience.

Caller ID

Call Waiting

3-Way Calling

Call Forwarding

### Caller ID

Caller ID identifies a caller before you answer the phone by displaying the number of the incoming call. If you do not want your number displayed when you make a call, follow these steps.

1. Press **\* A 6 F 7 Z**.
2. Enter the number you want to call.
3. Press .

To permanently block your number, call Sprint Customer Service.

### Call Waiting

When you're on a call, Call Waiting alerts you to incoming calls by sounding beeps. Your phone's screen informs you that another call is coming in and displays the caller's phone number (if it is available).

To respond to an incoming call while you're on a call:

- ▶ Press . (This puts the first caller on hold and answers the second call.)





To switch back to the first caller:

- ▶ Press  again.

**Tip:** For those calls where you don't want to be interrupted, you can temporarily disable Call Waiting by pressing **\* A 7 Z 0 @** before placing your call. Call Waiting is automatically reactivated once you end the call.

## 3-Way Calling

With 3-Way Calling, you can talk to two people at the same time. When using this feature, the normal airtime rates will be charged for each of the two calls.

1. Enter a number and press .
2. Once you have established the connection, press . (This puts the first caller on hold.)
3. Select **Contacts**, **Recent History**, or **Enter Phone#**.
4. Select a number from your Contacts or Recent History, or enter a number directly, and then press .
5. When you're connected to the second party, press  again to begin your 3-way call.







If one of the people you called hangs up during your call, you and the remaining caller stay connected. If you initiated the call and are the first to hang up, all callers are disconnected.

## Call Forwarding



Call Forwarding lets you forward all your incoming calls to another phone number – even when your phone is turned off. You can continue to make calls from your phone when you have activated Call Forwarding.

**Note:** You are charged a higher rate for calls you have forwarded.

To activate Call Forwarding:

1. Press      .
2. Enter the area code and phone number to which you want your calls forwarded.
3. Press . (You will hear a tone to confirm the activation of Call Forwarding.)

To deactivate Call Forwarding:

1. Press        .
2. Press . (You will hear a tone to confirm the deactivation.)

## Phone Call Settings

This section helps you customize your phone's call-related settings to suit your needs.

[Alert Notification](#)

[Call Answer Mode](#)



[Auto-Answer Mode](#)

[Headset Mode](#)

[Airplane Mode](#)

[TTY Use With Sprint Service](#)

[Use the Hearing Aid Device Compatibility Function](#)

## ***Alert Notification***

Set your phone to alert you with an audible tone when you change service areas, once a minute during a voice call, or when a call has been connected.

1. Press  > **Settings** > **Others** > **Alerts**.
2. Select **Beep Each Minute**, **Out of Service**, or **Connect**.
3. Select **On** or **Off**.

**Note:** For the **Repeated Tone** menu displayed in step 2, please see [Set Repeated Tone](#).

## ***Call Answer Mode***

Select how to answer incoming calls on your phone.

1. Press  > **Settings** > **Others** > **Call Setup** > **Call Answer**.
2. Select **Talk Key** or **Any Key**.

## ***Auto-Answer Mode***

Set your phone to automatically pick up incoming calls. Remember, your phone will answer calls in auto-answer mode even if you are not present.

1. Press  > **Settings** > **Others** > **Call Setup** > **Auto-Answer**.
2. Highlight an option and press .
  - **Hands-free** to answer calls automatically when the phone is connected to an optional headset or hands-free device.
  - **Speakerphone** to answer calls automatically in speakerphone mode.
3. Highlight the time you would like your phone to wait before answering and press .

## ***Headset Mode***

Set up your phone for hands-free use, the type of headset (mono or stereo), and the ringer mode.

To set the audio mode:

- ▶ Press  > **Settings** > **Others** > **Headset Mode** > **Earpiece** > **Stereo** or **Mono**.

To set the ringer mode:

- ▶ Press  > **Settings** > **Others** > **Headset Mode** > **Ringer Sound** > **Normal** or **Headset Only**.

## *Airplane Mode*

Airplane Mode allows you to use many of your phone's features, such as games and voice memos, when you are in an airplane or in any other area where making or receiving calls or data is prohibited. When you set your phone to Airplane Mode, it cannot send or receive any calls or access online information.

1. Press  > **Settings** > **Others** > **Airplane Mode**.
2. Read the disclaimer and press .
3. Select an option from the following:
  - **On** to activate Airplane Mode. Airplane Mode will be deactivated when you turn the phone off.
  - **Off** to deactivate Airplane Mode.
  - **On Power-up** to activate Airplane Mode each time you turn the phone on.

While in Airplane Mode, your phone's screen will display "Phone Off."

## *TTY Use With Sprint Service*

A TTY (also known as a TDD or Text Telephone) is a telecommunications device that allows people who are deaf, hard of hearing, or who have speech or language disabilities to communicate by telephone.

Your phone is compatible with select TTY devices. Please check with the manufacturer of your TTY device to ensure that it is compatible with digital cell phones. Your phone and TTY device will connect via a special cable that plugs into your phone's headset jack. If this cable was not provided with your TTY device, contact your TTY device manufacturer to purchase the connector cable.

To turn TTY Mode on or off:

1. Press  > **Settings** > **Others** > **Accessibility** > **TTY**. (You will see an informational message.)
2. Press .

3. Select one of the following options:

- **TTY Off** to disable TTY mode.
- **TTY VCO** to enable TTY mode in Voice Carry Over mode, which allows you to send voice and receive text during a call.
- **TTY HCO** to enable TTY mode in Hearing Carry Over mode, which allows you to send text and receive voice during a call.
- **TTY Full** to enable all TTY settings. You can send and receive text during a call.

To access the state Telecommunications Relay Service (TRS) for assistance with TTY calls:

► Dial     and press  to reach an operator.

For additional information about Sprint Relay Services and TTY compatibility, call Sprint Relay Customer Service at **800-676-3777** or visit [sprintrelay.com](http://sprintrelay.com).

**Note:** In TTY Mode, your phone will display the TTY icon if a TTY device or an optional headset is connected to your phone.

**Note:** When enabled, TTY mode may impair the audio quality of non-TTY devices connected to the headset jack.

**Warning:**     **911 Emergency Calling**

Sprint recommends that TTY users make emergency calls by other means, including Telecommunications Relay Services (TRS), analog cellular, and landline communications. Wireless TTY calls to 911 may be corrupted when received by public safety answering points (PSAPs), rendering some communications unintelligible. The problem encountered appears related to software used by PSAPs. This matter has been brought to the attention of the FCC, and the wireless industry and the PSAP community are currently working to resolve this.

## *Use the Hearing Aid Device Compatibility Function*

Your phone has been tested and rated for hearing aid device compatibility. To use this function effectively, set the **Hearing Aid** option to **On**.

1. Press  > **Settings** > **Others** > **Accessibility** > **Hearing Aid**.
2. Read the disclaimer and press .
3. Select **On** or **Off**.
  - **On** to use a hearing aid device with your phone.
  - **Off** to use your phone without a hearing aid device.

# Settings

---

This section provides an overview of items you can change using your phone's **Settings** menus.

[Display Settings](#)

[Volume Settings](#)

[Ringer Settings](#)

[Messaging Settings](#)

[Roaming](#)

[Security Settings](#)

## *Display Settings*

Adjusting your phone's display settings not only helps you see what you want, it can also help increase battery life.

[Change the Screen Saver](#)

[Change the Brightness](#)

[Change the Backlight Settings](#)

[Set the Notification Pop-up](#)

[Select a Picture ID](#)

[Power Save Mode](#)

[Change the Clock/Calendar Display](#)

[Set a Custom Greeting](#)

[Change the Phone's Menu Style](#)

[Change the Font Size](#)

[Display Language](#)

## *Change the Screen Saver*

You can set a screen saver to display while in standby mode.

1. Press  > **Settings** > **Display** > **Screensaver**.

2. Select a screen saver option by pressing the navigation key up or down, and select a screen saver.

## *Change the Brightness*

You can adjust the brightness on the display screen.

1. Press  > **Settings** > **Display** > **Brightness**.
2. Highlight a brightness level and press  twice.

## *Change the Backlight Settings*

Select how long the display screen remains backlit after any keypress is made. You can also change the backlight settings for when a Java application is running in the foreground.

To change the display screen backlight setting:

1. Press  > **Settings** > **Display** > **Backlight**.
2. Select **Backlight Dim** or **Backlight Off**.
  - If you select **Backlight Dim**, select **Always Bright**, **Always Dim**, or a preset length of time to elapse before the screen backlight dims.
  - If you select **Backlight Off**, select a preset length of time to elapse before the screen and keyboard backlights turn off. (When you select **Always Bright** for the **Backlight Dim** setting above, the keyboard backlight will turn off after about one minute.)

**Note:** Long backlight settings reduce the battery's talk and standby times.

To change the backlight for when a Java application is running in the foreground:

- ▶ Press  > **Settings** > **Display** > **Backlight** > **Java Backlight** > **Default** or **Continuous**.

## *Set the Notification Pop-up*

This option allows you to enable or disable notification pop-up when you receive a new notification (except for incoming call and alarm) while an application is running.

1. Press  > **Settings** > **Display** > **Notification**.
2. Select **Enable Pop-up** or **Disable Pop-up**.

**Tip:** If you select **Disable Pop-up**, you will see only a notification icon. (The notification pop-up will not appear while an application is running.)

## *Select a Picture ID*

You can select an image as a picture ID.

1. Press  > **Settings** > **Display** > **Picture ID**.
2. Select **Contact**, **Unsaved Numbers**, or **Private / Unknown**.
  - If you select **Contact**, select an entry.
3. Select a picture ID option and press .
4. Select an image and press  to assign it.

## *Power Save Mode*

This feature helps conserve your battery power by automatically adjusting the backlight setting of your phone.

1. Press  > **Settings** > **Display** > **Power Save Mode**.
2. Select **On**. (Select **Off** to deactivate this feature.)
3. Read the message and press **CONTINUE** (left softkey).

## *Change the Clock/Calendar Display*

Choose which design of clock or calendar you want to display in standby mode.

1. Press  > **Settings** > **Display** > **Clock/Calendar**.
2. Highlight an option and press  twice.

## *Set a Custom Greeting*

You can display your own custom greeting in standby mode.

1. Press  > **Settings** > **Display** > **Greeting** > **Custom**.
2. Enter a custom greeting and press .
3. Press **DONE** (left softkey) to save your greeting.

## *Change the Phone's Menu Style*

Choose the layout of your phone's menu.

1. Press  to display the main menu.
2. Press the left softkey (**LIST VIEW** or **GRID VIEW**) to change the menu style.

## *Change the Font Size*

Adjust the display font size for text in messages and for dial digits.

1. Press **OK** > **Settings** > **Others** > **Accessibility** > **Font Size** > **Messages** or **Dial Digits**.
2. Highlight a font size. You can see the highlighted font size in the New Size window.
3. If you are satisfied with the font size, press **SAVE** (left softkey).

## *Display Language*

You can choose to display your phone's onscreen menus in English or in Spanish.

1. Press **OK** > **Settings** > **Others** > **Language**.
2. Select **English** or **Español**.

## *Volume Settings*

Adjust your phone's volume settings to suit your needs and your environment.

### [Adjust the Phone's Volume Settings](#)

#### [Silence All](#)

## *Adjust the Phone's Volume Settings*

You can separately adjust the volume of various sounds your phone makes.

1. Press **OK** > **Settings** > **Volume**.
2. Select **Incoming Ringer**, **Playback Volume**, **Power Up/Down**, or **Key Beeps**.
  - If you select **Power Up/Down**, select **On** or **Off**.
  - If you select **Key Beeps**, select **Tone Volume** or **Tone Type**.
3. Select a volume level or type and press **OK**.

**Tip:** You can adjust the ringer volume whenever your phone is turned on, adjust the voice volume during a call, and adjust the volume during playback by using the volume button.

## *Silence All*

The Silence All option allows you to mute all sounds without turning your phone off.

To activate Silence All:

- ▶ Press and hold the volume button down. (The screen will display "Silence All.")

To deactivate Silence All:

- ▶ Press the volume button up repeatedly to select a volume level.

# Ringer Settings

Ringer types help you identify incoming calls and messages. You can assign ringer types to individual Contacts entries, types of calls, and messages.

[Select Ringer Types for Incoming Calls](#)

[Select Ringer Types for Messages](#)

[Select Ringer Types for Voicemail, Calendar, and Power Up/Down](#)

[Get New Ringers](#)

[Set Up Voice Guide](#)

[Select a Vibration Pattern](#)

## Select Ringer Types for Incoming Calls

1. Press  > **Settings** > **Ringers** > **Incoming Calls**.
2. Select **Contacts**, **Unsaved Numbers**, or **Private / Unknown**.
  - If you select **Contacts**, select **All Contacts**, or select **One Contact** and then select an entry.
3. Select a ringer option by pressing the navigation key up or down, and then select a ringer. (See [Get New Ringers](#) if you selected **Downloaded** > **Get New**.)

## Select Ringer Types for Messages

1. Press  > **Settings** > **Ringers** > **Messaging**.
2. Select **Messages** or **Email**.
3. For **Email**, skip to step 4. Otherwise, select **Contacts**, **Unsaved Numbers**, or **Private / Unknown**.
  - If you select **Contacts**, select **All Contacts**, or select **One Contact** and then select an entry.
4. Select a ringer option by pressing the navigation key up or down, and then select a ringer.

**Tip:** Ringer types can be assigned from the **Contacts** menu. See [Select a Ringer Type for an Entry](#).



## Select Ringer Types for Voicemail, Calendar, and Power Up/Down

1. Press  > **Settings** > **Ringers**.
2. Select **Voicemail**, **Calendar**, or **Power Up/Down**.
3. Select a ringer option by pressing the navigation key up or down, and then select a ringer.

## Get New Ringers

A wide variety of new ringers is available from the Sprint Digital Lounge, and you can access them right from your phone. (Additional charges may apply, but some are free.)

1. Press  > **Settings** > **Ringers**.
2. Select a ringer type category (**Incoming Calls**, **Voicemail**, **Messaging**, etc.) and any applicable subcategories.
3. Select **Downloaded** > **Get New**. (The Digital Lounge will launch and display the Ringers menu.)
4. Use the navigation key and keyboard to search through available ringers. When you find one you want, highlight it and press .
5. To purchase the ringer, use the navigation key to move the cursor over **Buy**. When the cursor changes from an arrow into a hand, press . (The ringer will download automatically.)
6. When the download is finished, select an option to continue:
  - **Listen** to listen to the ringer.
  - **Assign** to assign the ringer to a call or message type or to a specific contact.
  - **Shop** to browse for other items to download.

## Set Up Voice Guide

Voice Guide allows you to hear voice prompts and spoken numbers or key names as you press a key, and also to hear menus and options, Contacts names, email addresses, URLs, etc., as you highlight each item onscreen. (The default setting is **Off**.)

1. Press  > **Settings** > **Others** > **Accessibility** > **Voice Services** > **Voice Guide**.
2. Select **On** or **Off**.

**Note:** When the incoming ringer volume is set to **Silence All** or **Vibrate All**, and when the playback volume or the tone volume is set to **Volume Off**, Voice Guide does not work. (See [Volume Settings](#).)

## Select a Vibration Pattern

You can select vibration patterns for incoming calls, messages, alarms, and scheduled events.

1. Press  > **Settings** > **Others** > **Accessibility** > **Vibrate Type**.
2. Select **Incoming Calls**, **Voicemail**, **Messaging**, or **Alarm/Calendar**.
  - If you select **Messaging**, select **Messages** or **Email**.
3. Highlight a vibration pattern and press .

**Tip:** You can make the incoming ringer vibrate at any volume level by pressing **VIBRATE** (left softkey) on the volume setting screen.

## Messaging Settings

Your phone's advanced messaging capabilities let you send and receive different kinds of messages without placing a voice call.

Messaging settings allow you to create a signature with each sent message and your own preset messages.

[Set Clear Alerts Icon](#)

[Set a Callback Number](#)

[Add a Customized Signature](#)

[Manage Preset Messages](#)

[Set Repeated Tone](#)

[Set Long Message Reassembly](#)

### Set Clear Alerts Icon

Clear Alerts Icon will clear the envelope icon on the display.

1. From standby mode, press **MESSAGING** (left softkey) > **OPTIONS** (right softkey) > **Clear Alerts Icon**.
2. Press **YES** (left softkey).

### Set a Callback Number

You can specify the callback number your recipients see when you send messages.

1. From standby mode, press **MESSAGING** (left softkey) > **OPTIONS** (right softkey) > **Callback Number**.
2. Select **None**, **My Phone Number**, or **Other**. If you select **Other**, enter a callback number and press .

## *Add a Customized Signature*

Add a customized signature to each message you send.

1. From standby mode, press **MESSAGING** (left softkey) > **OPTIONS** (right softkey) > **Signature**.
2. Select **On**. (If you do not wish to attach a signature to your outgoing messages, select **Off**.)
3. Enter a signature and press .

## *Manage Preset Messages*

Your phone is loaded with 20 preset messages to help make sending messages easier. Customize or delete these messages, such as “Where are you?,” “Let’s get lunch,” and “Meet me at” to suit your needs, or add your own messages to the list.

To edit or delete a preset message:

1. From standby mode, press **MESSAGING** (left softkey) > **OPTIONS** (right softkey) > **Preset Messages**. The list of preset messages will be displayed.
2. To edit or delete a message, highlight it and press **OPTIONS** (right softkey).
3. Select **Edit**, edit the message, and press .

- or -

Select **Delete** > **YES** (left softkey) to delete the message. (You can also reset all messages by selecting **Reset all messages** > **YES** [left softkey].)

To change the language of the preset message:

1. From standby mode, press **MESSAGING** (left softkey) > **OPTIONS** (right softkey) > **Preset Messages**.
2. Press **OPTIONS** (right softkey) > **Select Language**.
3. Select **English** or **Spanish**.

## Set Repeated Tone

Set your phone to notify you with an audible tone and vibration when you have an alert for messaging application.

1. From standby mode, press **MESSAGING** (left softkey) > **OPTIONS** (right softkey) > **Repeated Tone**.
2. Select **Voicemail**, **Messages**, or **Email**.
3. Select an option:
  - **Single Tone** to notify you once when receiving a message of type selected in step 2.
  - **Repeated Tone** to notify you once a minute when you have a missed message of type selected in step 2.

**Tip:** You can also access the Repeated Tone menu by pressing  > **Settings** > **Others** > **Alerts**.

## Set Long Message Reassembly

Set your phone to receive new incoming long message in one single message, instead of separate, smaller messages.

1. From standby mode, press **MESSAGING** (left softkey) > **OPTIONS** (right softkey) > **Long Message Re-assembly**.
2. Select **On** or **Off**.

## Roaming

Roaming service allows you to make and receive calls or gain access to data networks when you are temporarily outside the Nationwide Sprint Network.

[Roaming Icon](#)

[Roaming on Other Networks](#)

[Check for Voicemail Messages While Roaming](#)

[Set Roaming Mode](#)

[Enable Roaming](#)

[Roaming Guards](#)

### Roaming Icon

Your phone's display screen always lets you know when you're off the Nationwide Sprint Network. Anytime you are roaming, the phone displays the roaming icon (  ).

## Roaming on Other Networks

When you're roaming on other networks, your call quality and security will be similar to the quality you receive when making calls on the Nationwide Sprint Network. However, you may not be able to access certain features, such as data services, depending on the available network.

**Note:** If you're on a call when you leave the Nationwide Sprint Network, your call is dropped. If your call is dropped in an area where you think Sprint service is available, turn your phone off and on again to reconnect to the network.

## Check for Voicemail Messages While Roaming

When you are roaming off the Nationwide Sprint Network, you may not receive on-phone notification of new voicemail messages. Callers can still leave messages, but you will need to periodically check your voicemail for new messages if you are in a roaming service area for an extended period of time.

1. Dial your area code + your phone number.
2. When you hear your voicemail greeting, press .
3. Enter your password at the prompt and follow the voice prompts.

When you return to the Nationwide Sprint Network, voicemail notification will resume as normal.

## Set Roaming Mode

Your phone allows you to control your roaming capabilities. By using the Roaming menu option, you can determine which signals your phone accepts. Choose from different settings on your phone to control your roaming experience.

## Enable Roaming

You can enable roaming on voice or data, domestic or international, separately.

1. Press  > **Settings** > **Others** > **Roaming** > **Roaming Mode**.
2. Select an option:
  - **Sprint Only** to access only the Nationwide Sprint Network and prevent roaming on other networks for both voice and data communications.
  - **Automatic** to seek service on the Nationwide Sprint Network. When Sprint service is unavailable, the phone searches for an alternate service. If this option is selected, you can select the type(s) of communication for which roaming should be allowed by selecting **Roaming Settings** under the Roaming menu:
    - **Domestic Voice** to allow voice communication only on domestic roaming systems.

- **Domestic Data** to allow data communication only on domestic roaming systems.
- **International Voice** to allow voice communication on international roaming systems.
- **International Data** to allow data communication on international roaming systems.

## Roaming Guards

Your phone alerts you when you are roaming off the Nationwide Sprint Network by requiring an extra step before you can place or answer a call, or try to access data while roaming.

**Note:** Roaming Guards are turned on by default on your phone.

1. Press  > **Settings** > **Others** > **Roaming** > **Roaming Guards**.
2. Select **Domestic** or **International**.
3. Select **Voice**, **Data**, or **Outgoing SMS** by checking the check box. (**Outgoing SMS** appears only when **International** is selected.)
  - For example, if you check **Data** under **International**, your phone alerts you when you are using an international roaming system to access data service.
  - If you check **Outgoing SMS** under **International**, your phone alerts you when you are using an international roaming system to send a text message.

**Tip:** If you prefer not to use the Roaming Guards feature, check the **Never Ask** check box while the alert dialog is displayed. You will not be notified of your roaming status until you enable it again.

To place roaming calls with a roaming guard on:

1. From standby mode, dial the area code + the seven-digit number and press .
2. Read the message and press .

To answer roaming calls with a roaming guard on:

- ▶ Read the message and press .

To access data service with a roaming guard on:

- ▶ Read the message and press **ROAM** (left softkey).

## Security Settings

Your phone offers a variety of security settings to manage the safety of your phone, phone contents, and phone use by children, etc.

Lock Your Phone

Parental Controls

Delete Phone Content

Reset Your Phone and Phone Content

Security Features for Data Services

## *Lock Your Phone*

When your phone is locked, you can only make calls to 911 and Sprint Customer Service.

1. Press  > **Settings** > **Lock Phone** and enter your lock code.
2. Select **Lock Now**.

**Tip:** The first time you access the Lock Phone menu, you will be advised to change the default lock code by pressing **CHANGE** (left softkey). Enter and re-enter your new lock code to proceed. For details, see [Change the Lock Code](#).

## *Unlock Your Phone*

1. From standby mode, press **UNLOCK** (left softkey).
2. Enter your lock code.

## *Change the Lock Code*

1. Press  > **Settings** > **Lock Phone** and enter your lock code.
2. Select **Change Lock Code**.
3. Enter and re-enter your new lock code. (You will be prompted to create a lock code hint to help you remember your new lock code.)
4. If you want to create a lock code hint, select **YES** (left softkey). Enter a hint and press .

- or -

Select **NO** (right softkey) to return to the previous menu.

To edit or delete a lock code hint:

1. Press  > **Settings** > **Lock Phone** and enter your lock code.
2. Select **Lock Code Hint**.

3. Edit the hint and press **OK**.

- or -

Delete the hint by pressing **↶** and press **OK**.

**Tip:** If you can't recall your lock code, try using the last four digits of your wireless phone number or check your lock code hint. If this doesn't work, call Sprint Customer Service at **1-888-211-4727**.

## *Parental Controls*

This feature allows parents to prevent children from using certain functions on the phone.

### *Activate Parental Controls*

1. Press **OK** > **Settings** > **Parental Controls** > **On/Off** > **On**.
2. Enter and re-enter your new code.

The next time you try to access this setting, you will be required to enter your Parental Controls code.

### *Change the Parental Controls Code*

1. Press **OK** > **Settings** > **Parental Controls** > **Change Parental Control Code**.
2. Enter and re-enter your new code.

### *Restrict Voice Calls and Messages*

1. Press **OK** > **Settings** > **Parental Controls** > **Restriction**.
2. Read the message and press **CONTINUE** (left softkey).
3. Select an option:
  - **Voice Calls** to restrict incoming and outgoing voice calls except those placed to 911 or Sprint Customer Service.
  - **Messages** to restrict sending messages except to designated recipients.
4. Select **On/Off** > **On**. Read the message and press **OK** (left softkey).
5. Select **Allowed Contacts** > **All Contacts** or **Choose Contacts**.
  - If you select **All Contacts**, press **OK** to confirm.



- If you select **Choose Contacts**, select **<Add Contact>**, and then choose a member from the list. If you want to remove a member from the list, highlight the member and press **REMOVE** (left softkey).

**Note:** If you select **On** in step 4, you cannot add, edit, and delete any Contacts or Group entries.

### *Restrict Web, Camera, and Location Mode*

1. Press  > **Settings** > **Parental Controls** > **Restriction**.
2. Read the message and press **CONTINUE** (left softkey).
3. Select an option:
  - **Web** to prevent using the browser.
  - **Camera** to prevent using the camera.
  - **Force Location On** to prevent turning the Location function off. (See [Location Mode](#).)
4. Select **On**.

### *Delete Phone Content*

You can quickly and easily delete all the content that you have created or stored in your phone.

1. Press  > **Settings** > **Reset/Delete** and enter your lock code.
2. Select **Delete Stuff**.
3. Highlight an option and press .
- **Messages** to delete all messages.
- **Call Logs** to delete all call history from the phone.
- **Browser Cookies and Cache** to delete all Web cookies and all Web cache memory saved in the phone.
- **Downloaded Content** to delete all data downloaded to your phone.
- **Contacts** to delete all of your Contacts including speed dial numbers saved in your Contacts.
- **Voice Memo** to delete all voice data and call memos saved in the phone.
- **My Photos** to delete all pictures stored in My Photos.
- **File Manager(In Phone)** to delete all files saved in File Manager.

- **All Stuff** to delete all user-added data.
4. Read the message and press **DELETE** (left softkey).

## *Reset Your Phone and Phone Content*

This option lets you clear different types of personal information stored on your phone, reset your phone to factory settings, or both.

1. Press  > **Settings** > **Reset/Delete**.
2. Enter your lock code.
3. Highlight an option and press .
  - **Reset Settings** to restore all the factory defaults, including ringer types and display settings. Contacts, History, Calendar, and Messaging are not affected.
  - **Reset Phone** to reset all settings and erase all data on your phone.
4. Read the message and press the left softkey (**RESET SETTINGS** or **RESET PHONE**).

## *Security Features for Data Services*

### *Enable Data Services*

Although your phone's data services are turned off by default, you may enable them at any time.

To enable data services:

1. Press  > **Settings** > **Others** > **Data Settings** > **Data** > **On**. (A message is displayed.)
2. Press **YES** (left softkey) to enable data services.

### *Disable Data Services*

You can disable data services again without turning off your phone; however, you will not have access to all data services, including Web, multimedia messaging, and email. Disabling data services will avoid any charges associated with these services. While signed out, you can still place or receive phone calls, check voicemail, and use other voice services.

To disable data services:

1. Press  > **Settings** > **Others** > **Data Settings** > **Data** > **Off**.
2. Read the disclaimer and press **DISABLE** (right softkey) to sign out.

## *Net Guard*

When you first connect to the Web, the Net Guard will be displayed to confirm that you want to connect. The Net Guard helps you avoid accidental connections. You can disable the Net Guard in the future by selecting **Auto-Connect** when you see Net Guard displayed.

To change your Net Guard settings:

- ▶ Press  > **Settings** > **Others** > **Data Settings** > **Net Guard**.
  - **On** to activate the Net Guard.
  - **Off** to deactivate the Net Guard.

**Note:** When enabled, Net Guard appears only once as long as you have not turned the phone off and on.

# History

---

History is a list of the last 60 phone numbers (or Contacts entries) for voice calls you placed, accepted, or missed. History makes redialing fast and easy. It is continually updated as new numbers or entries are added to the beginning of the list and the oldest entries are removed from the bottom of the list.

[View History](#)

[History Thread](#)

[History Details](#)

[History Options](#)

[Make a Call From History](#)

[Save a Number From History](#)

[Make a New Group Entry From History](#)

[Delete History](#)

## *View History*

There are a few ways to view History.

[Recent History List](#)

[History Icons](#)

## *Recent History List*

▶ Press  > **History**.

- or -

From standby mode, press .

Each entry contains the phone number (if available) and Contacts entry name (if the number is in your Contacts). Duplicate calls (calls from the same number) may appear only once on the list.

**Note:** History records only calls that occur while the phone is turned on. If a call is received while your phone is turned off, it will not be included in history.

**Note:** If you return a call from the voicemail menu, it will not be included in history.

## History Icons

You can determine if an entry was an incoming, outgoing, or a missed call from the history icons.

History Icons	Description
	Incoming Call
	Outgoing Call
	Missed Call

## History Thread

The History thread screen shows all history for a selected entry. You can also keep track of all the messages you have sent and received for the selected entry.

To display a History thread:

1. Press  > **History**.
2. Highlight an entry and press .

## History Details

The History details screen shows the number type (Mobile, Home, etc.), phone number, the caller's name (if the number is already in your Contacts), and date and time of the call. An onscreen menu is also displayed according to the type of call. (See [History Options](#).)

To display History details:

1. Press  > **History**.
2. Highlight an entry from the list and press . The History thread is displayed.
3. Highlight an entry and press .
4. To make a call from the History details screen, press .

## History Options

You may see several menu items on the onscreen menu. Press **OPTIONS** (right softkey) for additional options.

- **Call** to call the selected entry.
- **Send Message** to send a message to the selected entry.
- **New Group** to create a new Group entry.

- **Contact Details** to display information about the entry if it has already been saved in your Contacts.
- **Save Contact** to save a phone number. (See [Save a Number From History](#).)
- **Delete** to delete the entry.
- **Delete All** to delete all History entries. (See [Delete History](#).)
- **Prepend** to add numbers to the beginning of the selected number.

## *Make a Call From History*

1. Press  > **History**.
2. Highlight an entry and press .

**Note:** You cannot make calls from History to entries identified as **No Caller ID**, **Private (Restricted ID)**, or **Unavailable ID**.

## *Save a Number From History*

Your phone can store up to 600 Contacts entries, and each Contacts entry can store up to a total of seven phone numbers.

1. Press  > **History**.
2. Highlight a History entry and press **OPTIONS** (right softkey) > **Save Contact**.
3. Select **New Entry** or **Existing Entry**.
4. If **New Entry** was selected, select a number type, and then enter the new entry name.

- or -

If **Existing Entry** was selected, select an existing entry to which you want to save the number, and then highlight a number type and press .

5. Press **DONE** (left softkey) to save the entry.

## *Make a New Group Entry From History*

You can make and save a new group entry from History.

1. Press  > **History** > **OPTIONS** (right softkey) > **New Group**.
2. Read the message and press **START** (left softkey).

3. Select the check box for each member you wish to add and press **CONTINUE** (left softkey).

**Tip:** Press **OPTIONS** (right softkey ) > **Enter New Address** or **Contacts** to enter a new address or a phone number or to select an entry from your Contacts.

4. Enter a group name and press  > **SAVE** (left softkey).

## *Delete History*

You can delete individual or all entries in your History.

1. Press  > **History**.
2. Highlight an entry you wish to delete and press **OPTIONS** (right softkey) > **Delete**.
  - Select **Delete All** to delete all entries.
3. If you are certain you want to delete one or all entries from History, press **DELETE** (left softkey).

# Contacts

---

Your phone can store up to 600 Contacts entries. Each entry can contain up to seven phone numbers, and three email addresses, IM addresses, and Web addresses. You can also add Contacts entries to a Group, allowing you to send one message to up to 40 Contacts entries at a time.

[Display Contacts Entries](#)

[Add a New Contacts Entry](#)

[Edit a Contacts Entry](#)

[Add a Number to a Contacts Entry](#)

[Create a Group](#)

[Edit Groups](#)

[Find Contacts Entries](#)

[Use Contacts Information in Other Applications](#)

[Assign Speed Dial Numbers](#)

[Select a Ringer Type for an Entry](#)

[Assign a Picture to an Entry](#)

[Secret Contacts Entries](#)

[Dial Sprint Services](#)

## *Display Contacts Entries*

There are a few ways to display Contacts.

1. From standby mode, press **CONTACTS** (right softkey).

- or -

Press  > **Contacts**.

2. Highlight a name to show that entry's main phone number, or highlight a group to show how many members it has.

To view the history of a Contacts entry:



1. From standby mode, press **CONTACTS** (right softkey).
2. Highlight an entry and press **OPTIONS** (right softkey) > **Contact History**.

To view Contacts details:

1. From standby mode, press **CONTACTS** (right softkey).
2. Highlight an entry and press .
3. Highlight any data field and press . Menu options for that field will appear, if applicable.

**Note:** If you select a group in step 2, entries, phone numbers, or email addresses belonging to the group are displayed.

## *Add a New Contacts Entry*

You can add contacts with the detail information such as name, phone numbers, email addresses, and more.

1. From standby mode, press **CONTACTS** (right softkey) > **Add New...** > **New Contact**.
2. Enter a name for the new entry and press the navigation key down.
3. Enter the phone number for the entry and press .
4. Highlight a number type for the entry (**Mobile, Home, Work, Pager, Fax, or Other**) and press .
5. Add other information (email address, URL, street address, etc.).
6. Press **DONE** (left softkey).

**Tip:** **ICE – In Case of Emergency**

To make it easier for emergency personnel to identify important contacts, you can list your local emergency contacts under “ICE” in your phone’s Contacts list. For example, if your mother is your primary emergency contact, list her as “ICE–Mom” in your Contacts list. To list more than one emergency contact, use “ICE1–\_\_\_,” “ICE2–\_\_\_,” etc.

## *Edit a Contacts Entry*

Once you’ve added a contact, you can add or edit any of the information in the entry.

1. From standby mode, press **CONTACTS** (right softkey).
2. Highlight an entry and press **OPTIONS** (right softkey) > **Edit Contact**.
3. Highlight the information you wish to edit.

4. Add or edit the information and press .
5. Press **DONE** (left softkey) to save your changes.

## Add a Number to a Contacts Entry

1. From standby mode, press **CONTACTS** (right softkey).
2. Highlight an entry and press **OPTIONS** (right softkey) > **Edit Contact** > **<Add Number>**.
3. Enter the new phone number and press .
4. Highlight a label for the number and press .
5. Press **DONE** (left softkey) to save the new number.

## Create a Group

You can create a group by assigning Contacts entries as members and then naming the new group.

1. From standby mode, press **CONTACTS** (right softkey) > **Add New...** > **New Group**.
2. Read the message and press **START** (left softkey).
3. Highlight an entry you want to add to a group and press . A check mark will appear in the box next to the selected entry.
  - If the desired entry has multiple information of phone number or email address, select one of them using the right or left navigation key with the entry highlighted.

**Tip:** Press **OPTIONS** (right softkey) > **Enter New Address** or **Recent History** to enter a new phone number or new email address or to select an entry from your history.

4. When you have selected all the entries you want to add, press **CONTINUE** (left softkey).
5. Enter a name for the new group and press .
6. Press **SAVE** (left softkey).

## Edit Groups

Once you've added a group entry, you can add or edit any of the information in the entry.

[Change the Group Name or Group Icon](#)

[Add Members to a Group](#)

[Remove Members From a Group](#)

## Delete a Contacts Entry or Group

### *Change the Group Name or Group Icon*

1. From standby mode, press **CONTACTS** (right softkey).
2. Highlight the group you want to edit.
3. Press **OPTIONS** (right softkey) > **Edit Group**.
4. Change the group name or the group icon and press .
5. Press **SAVE** (left softkey).

### *Add Members to a Group*

1. From standby mode, press **CONTACTS** (right softkey).
2. Highlight the group to which you want to add members.
3. Press **OPTIONS** (right softkey) > **Edit Group** > **Add More**.
4. Read the message and press **START** (left softkey).
5. Highlight an entry you want to add and press .
  - If the desired entry has multiple information of phone number or email address, select one of them using the right or left navigation key with the entry highlighted.
6. Repeat step 5 to add additional members.
7. Press **CONTINUE** (left softkey) > **SAVE** (left softkey).

### *Remove Members From a Group*

1. From standby mode, press **CONTACTS** (right softkey).
2. Highlight the group from which you want to remove members.
3. Press **OPTIONS** (right softkey) > **Edit Group**.
4. Highlight a member and press **OPTIONS** (right softkey) > **Remove from Group** > **YES** (left softkey).
5. Repeat step 4 to remove additional members.
6. Press **SAVE** (left softkey).

### *Delete a Contacts Entry or Group*

1. From standby mode, press **CONTACTS** (right softkey).
2. Highlight an entry or a group you want to delete.

3. Press **OPTIONS** (right softkey) > **Delete Contact** or **Delete Group**.
4. Press **DELETE** (left softkey).

## Find Contacts Entries

There are a few ways to find Contacts entries.

1. From standby mode, press **CONTACTS** (right softkey).
2. Scroll through all the entries.

- or -

Enter the first few letters of an entry's name. Contacts with matching letters are listed. (The more letters you enter, the more your search narrows.)

3. To display an entry, highlight it and press .
- Press the navigation key left or right to display other listed entries.
4. To dial the entry, highlight the phone number and press .

**Tip:** You can also find groups the same way as above. Press  to display the members of the group.

## Use Contacts Information in Other Applications

You can use saved Contacts information in other applications.

To copy information into a message:

1. From standby mode, press **CONTACTS** (right softkey).
2. Highlight an entry and press .
3. Highlight the information you want to copy, such as phone numbers, email addresses, URLs, or street addresses, and press .
4. Select **Share**.
5. Select **Message** or **Email**.

After you select one or more recipients, the text entry screen for the type of message specified will open, and the selected text will appear in the body of the message.

**Note:** For more information about messaging, see [Messaging](#).

## Assign Speed Dial Numbers

Your phone can store up to 98 phone numbers in speed dial locations. (See [Speed Dialing](#).)

To assign a speed dial number to a new phone number:

1. Add a phone number to a new or to an existing Contacts entry. (See [Add a Number to a Contacts Entry](#).)
2. Highlight the phone number and press **OPTIONS** (right softkey) > **Set Speed Dial**.
3. Highlight an available speed dial location and press **OK**.
4. Press  to return to the Contacts menu.

To assign a speed dial number to an existing phone number:

1. From standby mode, press **CONTACTS** (right softkey).
2. Highlight an entry and press **OK**.
3. Highlight a number and press **OPTIONS** (right softkey) > **Set Speed Dial**.
4. Highlight an available speed dial location and press **OK**.

**Tip:** To replace a current assignment, select a location and press **REPLACE** (left softkey).

To check speed dial assignments:

1. From standby mode, press **CONTACTS** (right softkey).
2. Press **OPTIONS** (right softkey) > **Settings** > **Speed Numbers**.

## Select a Ringer Type for an Entry

Assign a ringer type to a Contacts entry so that you can identify the caller by the ringer type. (See [Ringer Settings](#).)

1. From standby mode, press **CONTACTS** (right softkey).
2. Highlight an entry and press **OK**.
3. Select **Set Ringers**.
4. Select **Incoming Calls** or **Message**.
5. Select **Change**.
6. Highlight a ringer category, such as **Default Ringer**, **Downloaded**, **Preloaded Ringers**, or **No Ringer** and then press **OK**.

7. Highlight a ringer and press .

**Tip:** If you select **Downloaded > Get New** in step 6, you can purchase and download new ringers right from your phone. For details, see [Get New Ringers and Download Games, Ringers, and More](#).

## Assign a Picture to an Entry

Assign a picture to display each time a certain contact calls you.

1. From standby mode, press **CONTACTS** (right softkey).
2. Highlight an entry and press .
3. Highlight  and press .
4. Select **Choose Photo**.
5. Select a photo category and press 
  - If you select **Take New Picture**, press  to take a picture, and then press **OK** (left softkey) to assign it.
6. Select an image and press  to assign it.

## Secret Contacts Entries

When you make an entry secret and hide it, that entry is not displayed in your Contacts. In History, a telephone number is displayed but the Contacts entry's name is not.

To make an entry secret or not secret:

1. From standby mode, press **CONTACTS** (right softkey).
2. Highlight an entry and press **OPTIONS** (right softkey) > **Set as Secret** or **Set as Not Secret**.

To hide or show secret entries:

1. From standby mode, press **CONTACTS** (right softkey).
2. Press **OPTIONS** (right softkey) > **Settings** > **Hide Secret** or **Show Secret**.
3. Enter the four-digit lock code.

**Tip:** If you can't recall your lock code, try using the last four digits of your wireless phone number. If this doesn't work, call Sprint Customer Service at **1-888-211-4727**.

## Dial Sprint Services















Your Contacts list is preprogrammed with contact numbers for various Sprint services.

To dial a service from your Contacts:

1. From standby mode, press **CONTACTS** (right softkey).
2. Press **OPTIONS** (right softkey) > **Settings** > **Services**.
3. Select **Hear Minutes** (Account Info.), **Customer Solution** (Service), **Directory Assistance** (Sprint 411), **Sprint Operator**, **Hear Balance**, **Voicemail**, **Community Information**, **Non Emergency Services**, **Traffic Information**, **Carrier Repair Service**, **TRS Relay for TTY**, **Call Before You Dig**, or **Emergency**.
4. Press .

To dial a main service from standby mode using your keyboard:

► Dial the appropriate service number:

- **Account Info.** –     
- **Customer Service** –     
- **Sprint 411** –       
- **Sprint Operator** –   

# Messaging

---

Messaging allows you to stay connected 24 hours a day anywhere on the Nationwide Sprint Network. With your phone, you can use two types of messaging, text messaging (SMS) and multimedia messaging (MMS), as well as the email application.

## Text Messaging and Multimedia Messaging

### Email

## Text Messaging and Multimedia Messaging

With messaging, you can send and receive messages between your phone and another messaging-ready phone. When you receive a new message, it will be automatically displayed on your phone's screen.

In addition, messaging includes a variety of preset messages, such as "The meeting has been cancelled," that make composing messages fast and easy. Use your phone to customize your own preset messages (up to 50 characters).

Text messages can be composed of up to six segments of 160 (140 in Spanish) characters each, for a total of 960 (840 in Spanish) characters per text message. The current segment and total segment count is displayed at the top of each segment. For example, (5/6) at the top of a segment would indicate you are viewing segment five of a six-segment message.

Multimedia messages consist of both text and multimedia files, such as pictures or voice recordings. Outgoing multimedia messages can be up to 600 KB with up to 1000 text characters.

## Compose Messages

### Access Messages

### Threaded Messaging

## Compose Messages

1. From standby mode, press **MESSAGING** (left softkey).

- or -

Press  > **Messaging**.

2. Select **Send Message**.
3. Select a recipient from the list or from the following options:



- **Go to Contacts** to select a recipient from your Contacts. (Qualifying Contacts entries must contain a phone number or an email address.)
  - **MULTIPLE** (left softkey) to select multiple recipients. Press **CONTINUE** (left softkey) when you have finished selecting recipients. (You may include up to 40 recipients per message.)
  - **NEW ADDRESS** (right softkey) to enter a recipient's phone number or email address directly. Press **CONTINUE** (left softkey) to proceed.
4. Compose a message.
    - Press **OPTIONS** (right softkey) to select additional options.
  5. Select **<Add Attachment>** and select a category of files you would like to attach (**Picture, Voice, Audio, or File Manager**).
  6. Select a location where your file is stored. (You can also choose to take a new picture or to record a new voice or audio clip.)
  7. Select files you would like to attach.
  8. Review your message and press **SEND** (left softkey).

## *Access Messages*

To read a message:

- ▶ When you receive a message, your phone will display a notification message. Select **View**.

To reply to a message:

1. While the message is displayed, press **REPLY** (left softkey).
  - Select **Reply to Sender**, or select **Reply All** if you are replying to an MMS message with multiple recipients.
2. Compose a reply and press **SEND** (left softkey).

## *Threaded Messaging*

Threaded messaging lets you follow a chain of messages to and from a particular contact.

To display the thread list:

- ▶ From standby mode, press **MESSAGING** (left softkey) > **Messages**.

You will see a thread list. Each thread has an entry's name (if saved in Contacts), a phone number, or an email address. You will also see the number of unread messages, if any, for each thread.

## View Messages

Highlight a thread and press  to display the messages sent to and received from a particular contact, in reverse chronological order. Failed, pending, and draft messages are also listed.

Highlight a message to see details for that message.

- **Me** – Message you sent.
- **Me (Failed)** – Message you did not send successfully.
- **Me (Pending)** – Message you have not sent yet because your phone has no network connection. The message will be sent automatically when your phone reconnects to the network.
- **Me (Draft)** – Message you saved as a draft. Only one draft can be saved in each thread, and that draft appears at the top of the thread.

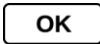

## Message Details

Highlight a message and press  to display the message details and view the entire message.

You can select certain information from a message or email message and automatically save it or use it in a related application. See [Simple Data Exchange](#).

## Threaded Messaging Options

When you are viewing a messaging thread list, a message thread, or a message details screen, you can choose from among the following options. (Options will vary according to screen.)

- ▶ Press  or  to make a call.
- ▶ Press **SEND MESSAGE** (left softkey) to send a message to the entry.
- ▶ Press **REPLY** (left softkey) to reply to a message.
- ▶ Press **SEND** (left softkey) to send a draft message.
- ▶ Press **RESEND** (left softkey) to resend a failed message.
- ▶ Select a message, press **OPTIONS** (right softkey) and select an option:
  - **Forward** to forward the selected message.
  - **Lock** to lock the selected message.
  - **Unlock** to unlock the selected message.

- **Unlock All** to unlock all messages.

**Note:** Messages are automatically deleted starting with the oldest. To save messages, lock them.

- **Delete** to delete the selected message.
- **Delete All** to delete all messages.
- **Call** to dial the phone number appearing in the selected message.
- **Launch** to open the URL appearing in the selected message.
- **Save Number** to save the phone number appearing in the selected message.
- **Save Email** to save the email address appearing in the selected message.
- **Manage Text Blocking** to block text messages from specific phone numbers or email addresses.
- **Block This Sender** to block text messages from the phone number or email address of the selected message's sender.
- **Settings** to display the Messaging Settings menu.
- **Combine/Uncombine** to put together the selected multi segmented text messages into a single message, or to do the reverse.

## *Email*

Your phone's email application lets you access and manage multiple email accounts simultaneously in one convenient location. (The following procedures are subject to the application updates.)

### [Get Started With Email](#)

#### [Access Email](#)

### *Get Started With Email*

1. Press  > **Messaging** > **Email**. (The email setup wizard will start.)
2. Press  to continue.
3. Select **Windows Live Hotmail**, **Yahoo!**, **Gmail**, or **AOL Mail**.

- or -

Select **Work** to set up a corporate email account.

- or -

Select **More...** to choose from additional options. There are many available email options listed, or you may add your own IMAP or POP email accounts.

**Note: Work Email Setup:** Consult your company's IT department for required information and permissions for any work email accounts. Read the onscreen setup instructions for additional information about setting up and using work email options on your phone.

4. Follow the setup wizard instructions to enter the required sign-up information, such as your email address and password. Press **OK** or **NEXT** (right softkey) to sign in.

**Note:** The information required or procedures to sign in will vary depending on the email provider you are accessing.

5. Follow the onscreen instructions to read, reply to, compose, and send messages and manage your email account.

## Access Email

Using email on your phone is even easier than using multiple email accounts on your computer. Launch the application for instant access to all your accounts. (The following procedures are subject to the application updates.)

1. Once you have set up your email, press **OK** > **Messaging** > **Email** to launch the application. When appears your account list screen, select an email account to see your inbox.

- or -

From an **New Email** notice, select **VIEW** (left softkey) to go to your inbox.

**Tip:** To manually check for new messages, press **OPTIONS** (right softkey) > **Check Email** with an account highlighted on your account list screen.

**Tip:** To add a new account, press **OPTIONS** (right softkey) with an account highlighted on your account list screen, and then select **Add Account** > **Email**. Follow the instructions in [Get Started With Email](#) to set up a new account.

2. Use your keyboard and navigation key to read, manage, and reply to your email messages.
  - Press **OPTIONS** (right softkey) to select messaging options, such as **Reply**, **Compose**, or **Sort**.
  - Press **DELETE** (left softkey) to delete a message.

- To view a different email account, press the left and right navigational keys to change the account tab. You can also navigate to your account list screen by pressing  and select an available account.

# Calendar & Tools

---

Learn how to use many of your phone's productivity-enhancing features.

[Calendar](#)

[microSD Card](#)

[Voice Services](#)

[Alarm](#)

[Calculator](#)

[World Clock](#)

[Countdown Timer](#)

[Stopwatch](#)

## Calendar

Use Calendar to create and manage events, meetings, and appointments. Your Calendar helps organize your time and reminds you of up to 100 important events.

[Add an Event to the Calendar](#)

[Add a To Do List Item to the Calendar](#)

[Calendar Alerts](#)

[View Events](#)

[Delete Events](#)

### *Add an Event to the Calendar*

1. Press  > **Tools** > **Calendar** > **Personal Calendar**.
2. Highlight a day to which you would like to add an event and press **OPTIONS** (right softkey) > **Add Schedule**.
3. Enter a description and press .
4. Select a category for the event (Appointment, Meeting, etc.) by highlighting the category field and pressing .
5. Select a priority for the event by highlighting the priority field and pressing .

6. Select a start and end time for the event by highlighting the start and end time fields and pressing .
7. Enter a location for the event by highlighting the location field and pressing  > **EDIT** (left softkey). Press  when you have finished.
8. Select a ringer type for the alarm by highlighting the ringer field and pressing .
  - To download ringers, select **Downloaded** > **Get New**.
9. Select an alarm time by highlighting the alarm time field and pressing .
10. Select a repeat status for the alarm by highlighting the repeat field and pressing .
  - If you chose **Specific Period**, set a start and end date for the repeat and press **OK** (left softkey).
  - If you chose **Weekly**, select the check box for each day of week you wish to set and press **DONE** (left softkey).
11. Press **SAVE** (left softkey).

**Tip:** To change the calendar display views, press the left softkey (**WEEK** or **MONTH**) repeatedly to toggle between weekly and monthly views.

**Tip:** On the weekly view, press the navigation key up or down to display the previous week or the next week, respectively.

**Tip:** Press **OPTIONS** (right softkey) > **Settings** > **Holiday/Weekday** to enter holidays and weekdays. Besides accessing your personal calendar as described above, you can also access your work calendar by pressing  > **Tools** > **Calendar** > **Add Calendar**. This may incur additional charges. Please check the terms of your service agreement.

## *Add a To Do List Item to the Calendar*

Your phone can store and manage up to 40 To Do list items.

1. Press  > **Tools** > **Calendar** > **Personal Calendar**.
2. Highlight a day to which you would like to add a To Do list item and press **OPTIONS** (right softkey).
3. Press the navigation key right and select **Add To Do**.
4. Enter a description and press .
5. Select a category for the item (Appointment, Meeting, etc.) by highlighting the category field and pressing .

6. Select a priority for the item by highlighting the priority field and pressing .
7. Select a time and date for the item by highlighting the time and date field and pressing .
8. Select a status for the item by highlighting the status field and pressing . When you add an item, set it to **Needs Action**.
9. Press **SAVE** (left softkey).

## Calendar Alerts

If you have an event on the Calendar, your phone alerts you by a ringing or vibrating alarm and displays a summary of the event.

To respond to the alarm, select an available onscreen menu or press the appropriate softkey:

- ▶ Select **Snooze**, or press **SNOOZE** (left softkey) after selecting **View** (see below), to stop the alarm and start snooze mode (if applicable).
- ▶ Select **View** to display the event detail screen.
- ▶ Press **DISMISS** (right softkey) to clear the alarm (if applicable).

**Tip:** To change the alarm settings from the main menu, select **Tools > Calendar > Personal Calendar > OPTIONS** (right softkey) > **Settings > Alarm** to set the snooze options.

## View Events

**Tip:** Days with scheduled events are indicated by small colored rectangles just below the date. A rectangle's color depends on the repeat status for an event.

1. Press  > **Tools > Calendar > Personal Calendar**.
2. Highlight the day for which you would like to view events and press . The day's event list is displayed.

- or -

Press **OPTIONS** (right softkey) > **Schedule List** or **To Do List**.

3. Highlight an event and press . The event's details are displayed. You can edit the event on this screen.

## Delete Events

1. Press  > **Tools > Calendar > Personal Calendar**.



2. Highlight the day from which you would like to delete an event and press **OK**.

- or -

Press **OPTIONS** (right softkey) > **Schedule List** or **To Do List**.

3. Highlight an event and press **OPTIONS** (right softkey) > **Delete**.

4. Highlight an option and press **OK**.

- **This** to delete the highlighted event.
- **Select** to delete multiple events.
- **All on This List** to delete all events on the list.
- **All Completed Events** to delete completed To Do List items.

5. Press **YES** (left softkey).

To delete old events or all events:

► Press **OK** > **Tools** > **Calendar** > **Personal Calendar** > **OPTIONS** (right softkey) > **Delete Memory** > **Delete Old** (or **Delete All**) > **YES** (left softkey).

## *microSD Card*

You can use an optional microSD™ (Secure Digital) or microSDHC™ memory card (both not included) to expand the phone's available memory space. It allows you to store images and voice data in your phone.

**Note:** In this guide, the name of microSD™ memory card and microSDHC™ memory card is abbreviated as microSD card, microSD, or memory card.

**Note:** Be sure to use only recommended microSD cards (up to 32 GB). Using non-recommended microSD cards could cause data loss and damage your phone.

**Note:** Playback/recording of video (except animation files with the extension .cmx) and music (except musical files with the extension .mid or .midi) is not supported on your phone.

[Insert a microSD Card](#)

[Remove the microSD Card](#)

[Create Folders in the microSD Card](#)

[View Memory in the microSD Card](#)

[Format the microSD Card](#)

[Back Up Your Contacts Data to the microSD Card](#)

[Display Your microSD Card Folders](#)

[File Manager](#)

[Digital Print Order Format \(DPOF\)](#)

[Connect Your Phone to Your Computer](#)

## ***Insert a microSD Card***

1. Insert a flat object into the slot at the bottom of the battery compartment cover and lift up gently to remove.

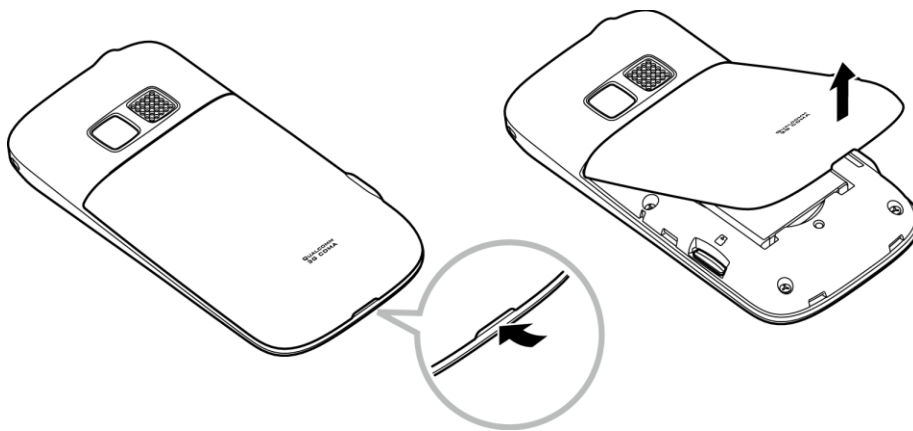

2. Insert a microSD card into the slot with the gold terminals facing down.
3. Gently press the card in until it snaps into place.

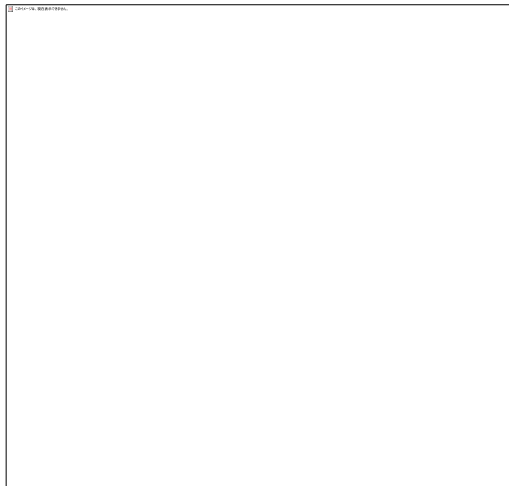

4. Replace the battery cover.

## Remove the microSD Card

1. Insert a flat object into the slot at the bottom of the battery compartment cover and lift up gently to remove.

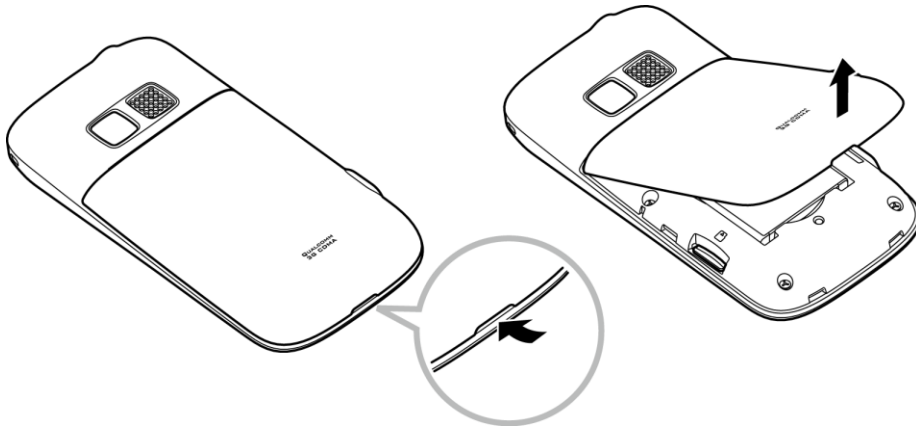

2. Push the card inward slightly and release, causing it to come about halfway out of the slot.

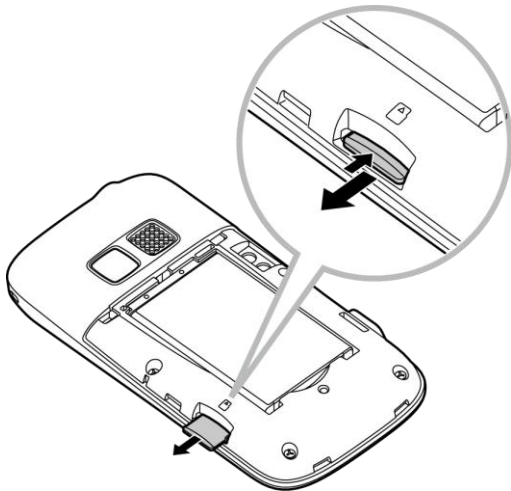

3. Gently remove the card from the slot.
4. Replace the battery cover.

**Note:** You can easily damage the microSD card by improper operation. Please be careful when inserting, removing, or handling the microSD card.

**Note:** Make sure your battery is fully charged before using the microSD card. Your data may become damaged or unusable if the battery runs out while using the microSD card.

## Create Folders in the microSD Card

The following steps allow your phone to create default folders for storing files in your microSD card.

- ▶ Press **OK** > **Tools** > **Memory Storage** > **Create Folders**. (The phone will create the default folders of microSD: **DCIM**, **VIDEO**, **MUSIC**, **VOICE**, **SD\_PIM**, **BLUETOOTH**, **EMAIL**, and **OTHER**.)

## *View Memory in the microSD Card*

Your phone allows you to review the memory allocation of both your internal storage area and that of the microSD card.

1. Press **OK** > **Tools** > **Memory Storage** > **Memory Info**.
  - The Memory Info page is divided into two sections: In Phone and Memory Card.
2. Press your navigation key down to display memory in the microSD card.

## *Format the microSD Card*

Formatting a microSD card permanently removes all files stored on the card.

1. Press **OK** > **Tools** > **Memory Storage**.
2. Highlight **Format Memory Card** and press **OK**. (A warning will be displayed.)
3. If you are sure you wish to remove all the files from your microSD card, press **YES** (left softkey).

**Note:** The formatting procedure erases all the data on the microSD card, after which the files **CANNOT** be retrieved. To prevent the loss of important data, please check the contents before you format the card.

## *Back Up Your Contacts Data to the microSD Card*

You can easily back up your phone's Contacts data to the microSD card.

1. Press **OK** > **Tools** > **Memory Storage** > **Save Contacts**. (You will see a confirmation message.)
2. Press **YES** (left softkey) to proceed. (Please wait while the system creates your data.)

**Note:** **DO NOT** remove a microSD card while files are being accessed or transferred. Doing so will result in loss or damage of data.

## *Display Your microSD Card Folders*

All the files stored in your microSD are accessible through your microSD card folders. For information on file and folder options available through File Manager, see [File Manager](#).

1. Press **OK** > **Tools** > **Memory Storage** > **File Manager** > **Memory Card**.
2. Highlight a folder and press **OK**.

3. To view or play a file, highlight it and press  or the appropriate softkey.

## *File Manager*

File Manager allows you to view, copy, move, and perform other housekeeping operations on files such as pictures, voice data, and applications stored in your phone or on the microSD card.

**Note:** Playback/recording of video (except animation files with the extension .cmx) and music (except musical files with the extension .mid or .midi) is not supported in your phone.

### *Access File Manager*

1. Press  > **Tools** > **Memory Storage** > **File Manager**.
2. Highlight an option and press .
  - **In Phone** to access files stored in your phone's memory.
  - **Memory Card** to access files stored on the memory card.

**Note:** All unknown or unsupported file types are displayed as ? or !.

### *Open Files in File Manager*

1. Press  > **Tools** > **Memory Storage** > **File Manager** > **In Phone** or **Memory Card**.
2. Highlight a folder and press .
3. Highlight an item and press .

### *File Manager Options*

When viewing files or folders in File Manager, press **OPTIONS** (right softkey) to display available options. Highlight an option and press  to select it.

- **Move** to move a file from the current folder to another folder in your phone or in the memory card.
- **Move to Card/Move to Phone** to move a file from one storage area to another.
- **Copy** to copy a file from the current folder to another folder in your phone or in the memory card.
- **Copy to Card/Copy to Phone** to copy a file from one storage area to another.
- **Delete** to delete a file or folder from File Manager.
- **Import** to import a Contacts file or a calendar file.

- **Sort by** to sort folder contents by name, date, or size.
- **Properties** to view the properties of the selected file.
- **Rename** to change the name of the selected file.

**Note:** You may not be able to use the file if you change the file name extension.

- **Assign** to set images as your screen saver or picture ID for Contacts entries.
- **Send via Bluetooth** to send a file to another Bluetooth device.
- **Send via email** to send a file as an email attachment.
- **Send Media** to send a file by attaching it to a message.
- **Print** to print an image using a Bluetooth-enabled printer.
- **Create Folders** to create preset folders on the memory card. (See [Create Folders in the microSD Card.](#))
- **List/Thumbnail** to switch between list view and thumbnail view.
- **Memory Info** to view the used and available memory space.
- **Go to Card/Go to Phone** to switch from one storage area to another.
- **Play/Listen/View** to play an animation file with the extension .cmx, listen to audio, or view a picture.

## *Digital Print Order Format (DPOF)*

Digital Print Order Format (DPOF) lets you set up digital print orders in advance, including options such as which pictures to print, number of prints, and index print settings.

1. Press  > **Tools** > **Memory Storage** > **DPOF Print Order**.
2. Select **Standard Print** (to print individual pictures) or **Index Print** (to print an index sheet of thumbnail images).
3. Press **OPTIONS** (right softkey) and select an option:
  - **Select Picture** to select a picture or pictures to print (up to 99).
  - **Photo Info** to display picture information.
  - **Unselect Picture** to cancel a picture selection.
  - **Set No. of Copies** to select the number of copies (up to 99 per picture) to print.

4. Press **SAVE** (left softkey) to save your settings. (If prompted, select whether to print the date on your pictures.)

### *Review DPOF Print Order Settings*

- ▶ Press **OK** > **Tools** > **Memory Storage** > **DPOF Print Order** > **Order Summary**.  
(The selected print options will be displayed.)

### *Clear a DPOF Print Order*

- ▶ Press **OK** > **Tools** > **Memory Storage** > **DPOF Print Order** > **Clear Order**.

## *Connect Your Phone to Your Computer*

Before using your phone's mass storage capabilities, you need to prepare your phone's data services to synchronize with your desktop or laptop computer. Once you have connected the phone to the computer, you can transfer your data to or from the microSD card.

1. Press **OK** > **Tools** > **Memory Storage** > **Connect to PC**. (You will see a confirmation message.)
2. Press **OK** (left softkey) to continue.
3. Connect your phone to your computer using a compatible USB cable. (Wait for the connection to be completed. When connected, the host computer will automatically detect your phone.)

To remove the connection:

- ▶ When you have finished transferring data, click the USB device icon in your computer's notification area, and follow the onscreen instructions to safely unplug the USB cable. (The process may vary depending on your computer.)

- or -

Press **EXIT** (left softkey) > **YES** (left softkey).

### *Important Connection Information*

- To avoid loss of data, **DO NOT** remove the USB cable, the microSD card, or the battery while files are being accessed or transferred.
- **DO NOT** use your computer to change or edit folder or file names on the microSD card, and do not attempt to transfer large amounts of data from the computer to the microSD card. Doing so may cause the microSD card to fail.
- **DO NOT** turn off or restart your computer, or put it into standby mode, while using a mass storage device. Doing so will result in loss or damage of data.

- While you are connected to the computer, your phone’s screen will display “Phone Off.” You cannot make or receive calls.
- If you connect a mass storage device to a peripheral device, your device may not work properly.

## Voice Services

Your phone comes with a built-in automatic speech recognition (ASR) and voice memo software.

### Automatic Speech Recognition (ASR)

#### Manage Voice Memos

### Automatic Speech Recognition (ASR)

Use your phone’s automatic speech recognition (ASR) software to dial a phone number or to launch phone functions. All you have to do is to talk into the phone, and ASR will recognize your voice and complete tasks by itself.

#### Activate ASR

▶ Press and hold  or .

The phone prompts you to say the name of the command you want to use. To complete your task, simply follow the voice prompts.

Available ASR commands include:



- **Call** <Name or #> to call an entry in your Contacts list or a spoken phone number. (See [Make a Voice Call Using ASR](#) for details.)
- **Send Message** <Name or #> to send a message to an entry in your Contacts list or to a spoken phone number. (See [Send a Message Using ASR](#) for details.)
- **Lookup** <Name> to display the detail screen of an entry in your Contacts list. (See [Display a Contacts Entry’s Information Using ASR](#) for details.)
- **Go To** <Menu> to jump directly to menu items or applications. (See [Open Menus Using ASR](#) for details.)
- **Check** <Item> to check your phone’s status. (See [Check Phone Status Using ASR](#) for details.)

**Tip:** Use ASR in a quiet environment so it can accurately recognize your commands.

**Tip:** During ASR operation, press **HELP** (left softkey) to get instructions for using the software.





## Make a Voice Call Using ASR

1. Press and hold  or .
2. When you hear “Say a command,” say “**Call.**”
3. When you hear “Say the name or number,” say a name or a phone number.
4. When you hear “Which location?,” say a number type (for example, “Mobile”).



**Tip:** You can skip steps 3 and 4 by saying a name and location after “Call” without pausing (for example, “**Call John Jones mobile**”).

**Note:** If ASR does not recognize the name or number, it will find the most likely matches and display a list of up to three names or numbers. You will hear “Did you say Call...” followed by the name or number. You can confirm by saying “**Yes.**” Say “**No**” to change the selection.

## Send a Message Using ASR



1. Press and hold  or .
2. When you hear “Say a command,” say “**Send Message.**”
3. When you hear “Say the name or number,” say a name or a phone number.
4. When you hear “Which location?,” say a number type (for example, “Mobile”). The phone displays the text entry screen. (See [Compose Messages](#) for how to compose a message.)

## Display a Contacts Entry’s Information Using ASR

1. Press and hold  or .
2. When you hear “Say a command,” say “**Lookup.**”
3. When you hear “Say the name,” say a Contacts entry’s name. The phone displays the detail screen for that Contacts entry.

## Open Menus Using ASR

You can jump directly to many menu items or applications by saying “Go to” followed by a menu option.

1. Press and hold  or .
2. When you hear “Say a command,” say “**Go To.**”
3. When you hear “Which shortcut?,” say an application name (for example, “Messaging”).



4. The phone opens the selected menu.

**Tip:** Say “**More options**” to display additional application names.

### *Check Phone Status Using ASR*



You can use ASR to obtain information about your phone:

- **Status** (all of the following except My Phone Number)
- **Time**
- **Signal Strength**
- **Network**
- **Battery**
- **My Phone Number**



1. Press and hold  or .
2. When you hear “Say a command,” say “**Check.**”
3. When you hear “Which status item?,” say a command.

### *ASR Settings*

To change ASR confirmation:

1. Press and hold  or .
2. Press **SETTINGS** (right softkey) > **Confirmation**.
3. Highlight an option and press 
  - **Automatic** to ask for confirmation only when the system is not sure what you said.
  - **Always Confirm** to always ask for confirmation.
  - **Never Confirm** to never ask for confirmation.



To adapt the system to your voice:

1. Press and hold  or .
2. Press **SETTINGS** (right softkey) > **Adaptation** > **Adapt Voice**.
3. Press **START** (left softkey) and repeat each word, phrase, or telephone number you hear.



To reset the adaptation:

1. Press and hold  or .
2. Press **SETTINGS** (right softkey) > **Adaptation** > **Reset Voice** > **YES** (left softkey).

To change the ASR mode:

1. Press and hold  or .
2. Press **SETTINGS** (right softkey) > **Audio Modes**.
3. Highlight an option and press .
  - **Expert Mode** to sound a beep only.
  - **Prompt Mode** to prompt for required information.
  - **Readout Mode** to prompt for required information and to read the text displayed on the display screen.

To change the ASR dialing region:

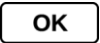
1. Press and hold  or .
2. Press **SETTINGS** (right softkey) > **Dialing Region**.
3. Highlight an option and press .
  - **North America** to recognize only numbers valid in North America.
  - **Other** to recognize any number regardless of location.

To display the ASR software version:

1. Press and hold  or .
2. Press **SETTINGS** (right softkey) > **About**.



## *Manage Voice Memos*

Use your phone's Voice Memo feature to record audio memos to remind you of important events, phone numbers, or grocery list items, and to record call memos of the other party's voice during a phone call.

**Note:** You can store up to 600 memos on your phone. Maximum recording time depends on the available memory space on your phone.

## Record Voice Memos

To record an audio memo:

1. Press **OK** > **Tools** > **Voice Services** > **Voice Memo** > **Record**.
2. Start recording after the beep.
3. To end the recording, press , , or **STOP** (right softkey).

To record the other party's voice during a phone call:

1. During a call, press **OPTIONS** (right softkey) > **Voice Memo**.
2. Start recording after the beep.
3. To end the recording, press  or **STOP** (left softkey).

**Note:** Only the other party's voice is recorded during this process.

## Play Voice Memos

To play single or all memos:

1. Press **OK** > **Tools** > **Voice Services** > **Voice Memo** > **List**.
2. Select **In Phone** or **Memory Card**.
3. Highlight the memo you want to play and press **OK**.

- or -

Press **OPTIONS** (right softkey) > **Play** > **All** to play all memos continuously.

To play multiple memos:

1. Press **OK** > **Tools** > **Voice Services** > **Voice Memo** > **List**.
2. Select **In Phone** or **Memory Card**.
3. Press **OPTIONS** (right softkey) > **Play** > **Multiple** and select memos you want to play.
4. Press **PLAY** (left softkey).

## Voice Memo Options

Your phone offers several options for managing voice memos you have recorded.

1. Press **OK** > **Tools** > **Voice Services** > **Voice Memo** > **List**.

2. Select **In Phone** or **Memory Card**.
3. Highlight a memo and press **OPTIONS** (right softkey) to display available voice memo options:
  - **Play** to play either selected memos or all memos. Select from **This**, **Multiple**, or **All**.
  - **Speaker On** or **Speaker Off** to activate or deactivate the speakerphone mode.
  - **Edit Title** to edit the title of a memo.
  - **Properties** to display information about a memo.
  - **Type Filter** to filter only audio memos, only call memos, or to display all memos.
  - **Sort by** to sort memos by recorded time, file name, or file size in ascending or descending order.
  - **Go to Time** to set the point from which the memo starts playing.
  - **Go to Card/Go to Phone** to switch between memos recorded on the memory card and to the In Phone folder.
  - **Send Media** to send an audio memo by attaching it to a message (displayed only when an audio memo is selected).
  - **Send via Bluetooth** to send memos via Bluetooth.
  - **Copy to Card/Copy to Phone** to copy selected memos to the memory card or to the In Phone folder.
  - **Move to Card/Move to Phone** to move selected memos to the memory card or to the In Phone folder.
  - **Delete** to delete either selected memos or all memos. Select from **This**, **Multiple**, or **All**.

## Alarm

Your phone comes with a built-in alarm that has multiple alarm capabilities.

1. Press  > **Tools > Alarm**.
2. Highlight an alarm number and press .
3. Turn the alarm on or off by highlighting the alarm field and pressing 
  - Highlight **On** or **Off** and press .

4. Enter a description for the alarm by highlighting the description field and pressing .
5. Select a time for the alarm by highlighting the time field and pressing .
6. Select a repeat status for the alarm by highlighting the repeat field and pressing .
7. Select a ringer option for the alarm by highlighting the ringer field and pressing .
8. Select a volume level for the alarm by highlighting the volume field and pressing .
9. Select a ringer length for the alarm by highlighting the ringer length field and pressing .
10. Select a snooze interval for the alarm by highlighting the snooze interval field and pressing .
11. Select the number of times the snooze should repeat by highlighting the snooze time field and pressing .
12. Press **SAVE** (left softkey).

**Tip:** Press **ON** or **OFF** (left softkey) to toggle the alarm on and off.

## Calculator

Your phone comes with a built-in calculator.

1. Press  > **Tools** > **Calculator**.
2. Enter numbers using your keyboard.
  - Press the appropriate key for an arithmetic option (+ - × ÷).
  - Press the left softkey to enter a decimal point.
  - Press **CLEAR** (right softkey) to clear all numbers.
3. Press  for the total.

## World Clock

To view the time in different locations:

1. Press  > **Tools** > **World Clock**.
2. Press the navigation key left or right to scroll through different time zones.

**Note:** Press **OPTIONS** (right softkey) > **Standard** or **Summer** to change between standard and daylight saving time.

## Countdown Timer

This feature allows you to use your phone as a countdown timer to alert you when a specified period of time has elapsed. You can set up to five timers.

1. Press  > **Tools** > **Countdown**.
2. Highlight a countdown timer number and press .
3. Highlight a setting and press .
  - **Time** to enter the length of the countdown.
  - **Alarm** to set the countdown alarm to on or off.
4. Press **SAVE** (left softkey).

**Tip:** Press **ON** or **OFF** (left softkey) to toggle the countdown alarm on and off.

## Stopwatch

Your phone comes with a built-in stopwatch.

1. Press  > **Tools** > **Stopwatch**.
2. Press **MODE** (left softkey) to select split timing or lap timing.
3. Press **START** (right softkey) to start the stopwatch.
4. Press **SPLIT** or **LAP** (left softkey) to record the time.
5. Press **STOP** (right softkey) to stop timing.
6. Press **RESET** (left softkey) to reset the stopwatch to zero.

# Camera

---

Your phone comes with a 1.3 megapixel camera.

[Take Pictures](#)

[Store Pictures](#)

[Send Pictures From Your Phone](#)

[Print Pictures From Your Phone](#)

## Take Pictures

Taking pictures with your phone's built-in camera is as simple as choosing a subject, aiming the lens, and pressing a button.

[Take a Picture](#)

[Assign Pictures](#)



[Camera Mode Options](#)

[Camera Settings](#)

### Take a Picture

1. Press  > **Photos** > **Camera** to activate camera mode. (Additional camera options are available. See [Camera Mode Options](#) for more information.)

**Tip:** To activate camera mode, you can also press and hold the camera button () located on the left side of your phone.

2. Using the phone's display screen as a viewfinder, aim the camera lens at your subject.
3. Press , , or **CAPTURE** (left softkey) until the shutter sounds. The picture will automatically be saved in the selected storage area. (See [Store Pictures](#).)
  - To return to camera mode to take another picture, press **CAMERA** (left softkey) or .
4. Press **OPTIONS** (right softkey) for more options.
  - **Send** to send your picture in a message. (See [Send Pictures From Your Phone](#).)
  - **Assign** to assign the picture. (See [Assign Pictures](#).)
  - **Delete** to delete the picture you just took.







- **Print** to print the picture. You can choose whether to print using a PictBridge- or Bluetooth-enabled printer.
- **Review Media** to go to the In Phone folder or memory card folder to review your saved pictures.
- **Details/Edit** to edit your picture or display details relating to your pictures.

## Assign Pictures

Assign a picture as a screen saver or as a picture ID.

1. Press  > **Photos** > **Camera** to activate camera mode.

**Tip:** To activate camera mode, you can also press and hold the camera button () located on the left side of your phone.

2. Using the phone's display screen as a viewfinder, aim the camera lens at your subject.
3. Press , , or **CAPTURE** (left softkey) until the shutter sounds. The picture will automatically be saved in the selected storage area. (See [Store Pictures.](#))
  - To return to camera mode to take another picture, press **CAMERA** (left softkey) or .
4. With the picture displayed, press **OPTIONS** (right softkey) > **Assign**, and select an option.
  - **Picture ID** to assign the picture to a Contacts entry as well as to unsaved phone numbers, or to private and unknown phone numbers. See [Select a Picture ID.](#)
  - **Screensaver** to assign the picture as a screen saver.

**Tip:** You can also assign pictures from the My Photos menu. See [In Phone and On Memory Card Folder Options.](#)

## Camera Mode Options

Press **OPTIONS** (right softkey) in camera mode to display additional camera options:

- **Picture Mode** to select a picture mode from **Normal**, **Beach/Snow**, **Scenery**, **Mirror Image**, or **Night/Dark**.
- **Zoom** to zoom in on a subject. (See [Zoom.](#))
- **Self-Timer** to activate the camera's timer. (See [Self-timer.](#))
- **Fun Tools** to select an option from the following:
  - **Multiple Shots** to take multiple shots. (See [Multiple Shots.](#))

- **Fun Frames** to select your favorite fun picture frame to decorate your picture (displayed only when the resolution setting is 0.3M or 0.1M).
- **Color Tone** to select from a wide variety of color tones for the picture.
- **Image Controls** to adjust settings for **Brightness**, **White Balance**, **Sharpness**, or **Contrast**.
- **Camera Settings** to adjust **Resolution**, **Quality**, and other settings. (See [Camera Settings](#).)
- **Review Media** to go to the In Phone folder or memory card folder to review your saved pictures.
- **Key Guidance** to show keyboard shortcuts in camera mode.
- **User Settings** to provide convenient access to your favorite settings.

### *Self-timer*

1. From camera mode, press **OPTIONS** (right softkey) > **Self-Timer**.
2. Highlight a delay time (**5 Seconds** or **10 Seconds**) and press .
3. Press  or **START** (left softkey) when you are ready to start the timer. (A countdown is displayed in the middle of the screen and your phone will beep during the countdown.)
4. Get ready for the picture. (When the timer is down to three seconds, the tone of the beep will change.)

To cancel the self-timer after it has started:

- ▶ Press **CANCEL** (right softkey) or .



### *Multiple Shots*

This feature allows you to take four or eight shots in a continuous sequence. When you take multiple shots, the  icon will be displayed on the upper left corner of the screen.

1. From camera mode, press **OPTIONS** (right softkey) > **Fun Tools** > **Multiple Shots**.

**Note:** When taking multiple shots, the resolution is temporarily set to **0.1M (320x240)**.

2. Highlight an option and press .
3. Highlight the duration of the interval between shots (**Normal** or **Fast**) and press .

4. Press , , or **CAPTURE** (left softkey) to take the pictures. (The screen will display up to eight thumbnail pictures.)

## Zoom

This feature allows you to zoom in on an object when you take a picture. You can adjust the zoom from 1x to 12x.

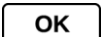
1. From camera mode, press the navigation key right to zoom in or left to zoom out.
2. Press , , or **CAPTURE** (left softkey) to take a picture.

## Camera Settings

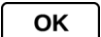
1. From camera mode, press **OPTIONS** (right softkey) > **Camera Settings**.
2. Highlight an option and press :
  - **Resolution** to select a picture's file size from **1.3M (1280x960)**, **0.3M (640x480)**, or **0.1M (320x240)**.
  - **Quality** to select the picture quality setting (**Fine**, **Normal**, or **Economy**).
  - **Shutter Sound** to select a shutter sound (**Default**, **"Say Cheese,"** or **"Ready"**).
  - **Status Bar** to display or hide status indicators and softkeys. These can be revealed or hidden by pressing the navigation key up or down.
  - **Auto Save to** to select the storage area for the pictures. (See [Storage Options](#).)
  - **Auto Review** to set the review time before returning to camera mode.

## Store Pictures

Your phone's picture storage area is called **My Photos**. There are two types of folders in My Photos:

- **In Phone** (see [In Phone Folder](#).)
- **On Memory Card** (see [On Memory Card Folder](#).)

### [Storage Options](#)

### [In Phone Folder](#)

### [On Memory Card Folder](#)

### [In Phone and On Memory Card Folder Options](#)

### [Review Pictures in Assigned Media Folder](#)

## Storage Options

1. Press  > **Photos** > **Other Settings** > **Auto Save to**.
2. Select **In Phone**, **On Memory Card** or **Switch w/Card**. (**Switch w/Card** stores pictures to the memory card when the card is installed.)

## In Phone Folder

Your phone's internal storage area is called the **In Phone** folder. From the In Phone folder, you can view all the pictures you have stored there, delete files, and access additional options.

To review your stored pictures in the In Phone folder:

- ▶ Press  > **Photos** > **My Photos** > **In Phone**.

## On Memory Card Folder

You can save pictures directly to the memory card using your phone's photo settings.

To review your stored pictures on the memory card:

- ▶ Press  > **Photos** > **My Photos** > **On Memory Card**.

## In Phone and On Memory Card Folder Options

When you are viewing the In Phone or On Memory Card folder, press **SEND** (left softkey) to send your pictures (see [Send Pictures From Your Phone](#)), or press **OPTIONS** (right softkey) to display the following options:

- **Select Multiple** to select multiple pictures.
- **Slideshow** to view your pictures in slideshow mode (only available when you save two or more pictures to the folder).
- **Assign** to assign the picture. Select an option and press .
- **Delete** to delete pictures. Select **This**, **Selected**, or **All**.

**Note:** Deleting data will free up memory space in your phone to enable you to take more pictures.

- **Print** to print pictures. You can choose whether to print using a PictBridge- or Bluetooth-enabled printer.
- **Copy/Move to Card** to copy or move pictures from your phone to the memory card.
- **Copy/Move to Phone** to copy or move pictures from the memory card to your phone.
- **Copy/Move** to copy or move pictures from a memory card folder to another memory card folder.

- **Details/Edit** to edit or display details relating to your pictures.
  - **Text Caption** to edit the selected picture's caption.
  - **Special Effects** to select from **Fun Frames**, **Color Tone**, **Fun Stamps**, or **Rotate**.
  - **Resize** to resize the selected picture. Select **0.3M (640x480)** or **0.1M (320x240)**. (Some options may not be available depending on the size of picture you have.)
  - **Trimming** to crop the selected picture.
  - **Photo Info** to display information such as the picture's caption, time/date, and size.
  - **Full Screen** to display the selected picture in full screen view.

## *Review Pictures in Assigned Media Folder*

The Assigned Media folder automatically stores copies of pictures assigned as picture IDs or screen savers on your phone. (See [Assign Pictures](#).)

1. Press  > **Tools** > **Assigned Media**.
2. Use your navigation key to view and scroll through the pictures. (To switch a picture from thumbnail view to expand view mode, highlight a picture and press .)

## *Send Pictures From Your Phone*

Once you have taken a picture, you can use the messaging or Bluetooth capabilities of your phone to instantly share it with family and friends as an attachment.

[Send Pictures Using the Messaging Feature](#)

[Send Pictures Using the Bluetooth Feature](#)

### *Send Pictures Using the Messaging Feature*

1. Press  > **Photos** > **My Photos** > **In Phone** or **On Memory Card**.
2. Select your pictures to send.
  - Press **OPTIONS** (right softkey) > **Select Multiple** to select multiple pictures.
3. Press **SEND** (left softkey) > **Contact**.
4. Select the recipient from the list or from the following options:
  - **Go to Contacts** to select a recipient from your Contacts. (Qualifying Contacts entries must contain a wireless phone number or an email address.)

- **MULTIPLE** (left softkey) to select multiple recipients. Press **CONTINUE** (left softkey) when you have finished selecting and entering recipients. (You may include up to 40 recipients per message.)
  - **NEW ADDRESS** (right softkey) to enter a recipient's wireless phone number or email address directly. Press **CONTINUE** (left softkey) to proceed.
5. Compose a message.
  6. Confirm the recipients, message, and pictures. (You may also select additional options by pressing the right softkey. Follow the onscreen instructions to add available options.)
  7. Press **SEND** (left softkey) to send the pictures.

## *Send Pictures Using the Bluetooth Feature*

1. Press  > **Photos** > **My Photos** > **In Phone** or **On Memory Card**.
2. Select your pictures to send.
  - Press **OPTIONS** (right softkey) > **Select Multiple** to select multiple pictures.
3. Press **SEND** (left softkey) > **Bluetooth**.
4. Select a device and press .
5. Read the message and press **SEND** (left softkey).
6. Follow the onscreen instructions to proceed.

## *Print Pictures From Your Phone*

Your phone is PictBridge compatible, allowing you to print directly from your phone without connecting to a computer. You can also print your pictures using Bluetooth (see [Print Pictures via Bluetooth](#)).

**Note:** Make sure your battery is fully charged before printing your pictures.

To print pictures directly from your phone:

1. Press  > **Photos** > **My Photos** > **In Phone** or **On Memory Card**.
2. Highlight a picture to print and press **OPTIONS** (right softkey) > **Print** > **PictBridge**.
  - Press **OPTIONS** (right softkey) > **Select Multiple** to select multiple pictures.
3. Connect your phone to the PictBridge-enabled printer using a compatible USB cable. When the printer has connected, press **CONTINUE** (left softkey) in the picture thumbnail screen.

**Note:** You may not be able to print pictures that you cannot display on your phone.

**Note:** While you are connected to the printer, your phone's screen will display "Phone Off." You cannot make or receive calls during this time.

4. Set the print settings using your navigation key.
  - **Type:** You can select the print mode from **Default Printer**, **Standard Print**, or **Index Print**.
  - **Copies:** You can set the number of copies from **Single**, **Doubles**, or **Manual** (up to 10 per picture).
  - **Size:** You can set the print size from **Default Printer**, **4"x6"**, **5"x7"**, **8"x10"**, or **Letter**. (Print sizes may vary according to the type of printer you have.)
  - **Date:** You can imprint the date on your pictures. Select **On** or **Off**. (Date stamping may not be available depending on the type of printer you have.)
5. When you have finished selecting the print settings, press **PRINT** (left softkey).
6. When printing is finished, press .
7. Press **YES** (left softkey). Follow the instructions on the display to unplug the USB cable from the phone.

#### **Printer Error Messages:**

From time to time you may encounter printing problems. Your phone will display any printer error messages informing you of the specific problems encountered. Please refer to the user's guide that came with your printer for descriptions, explanations, and possible resolutions for any error messages.

# Bluetooth

---

Bluetooth® is a short-range communications technology that allows you to connect wirelessly to a number of Bluetooth devices, such as headsets and hands-free car kits, and Bluetooth-enabled handhelds, computers, printers, and wireless phones. The Bluetooth communication range is usually up to approximately 30 feet.

[Turn Bluetooth On and Off](#)

[Make Your Phone Discoverable](#)

[Bluetooth Menu](#)

[Pair Bluetooth Devices](#)

[Trusted Devices List](#)

[Send Items via Bluetooth](#)

[Print Pictures via Bluetooth](#)

## Turn Bluetooth On and Off

By default, your phone's Bluetooth feature is turned off. Turning Bluetooth on enables your phone's Bluetooth functions.

1. Press  > **Tools** > **Bluetooth** > **On/Off**.
2. Press **ON** (left softkey) to enable Bluetooth. Press **OFF** (left softkey) to disable Bluetooth.

**Note:** Turn off Bluetooth when not in use to conserve battery power, or in places where using a wireless device is prohibited, such as aboard an aircraft and in hospitals.

## Make Your Phone Discoverable



To make your phone discoverable (allowing other Bluetooth devices to detect it), you must set your phone's visibility to other than **Hidden**.

1. Press  > **Tools** > **Bluetooth** > **Visibility**.
2. Select **Visible for 3 min** or **Always visible**. If you select **Always visible**, your phone will be discoverable by all in-range Bluetooth devices until you change the setting. If you select **Visible for 3 min**, your phone will return to hidden mode after three minutes.

### Bluetooth Status Indicators

The following icons show your Bluetooth connection status at a glance:



Bluetooth Icons	Description
	Your phone's Bluetooth service is on.
	Your phone is visible to other Bluetooth devices.
	Your phone is connected to a Bluetooth device.

The above icons will blink while your phone is communicating with a Bluetooth device.

## Bluetooth Menu

The **Bluetooth** menu allows you to set up many of the characteristics of your phone's Bluetooth service, including:

- Setting your phone's visibility (or "discoverability") for other Bluetooth devices.
- Adding a new Bluetooth device to your phone.
- Displaying your Bluetooth trusted devices list.
- Displaying your phone's Bluetooth information.

To access the Bluetooth menu:

- ▶ Press **OK** > **Tools** > **Bluetooth** to select from following options:
  - **On/Off** to enable or disable Bluetooth.
  - **Visibility** > **Hidden**, **Visible for 3 min**, or **Always visible** to set your Bluetooth visibility.
  - **Add New** to add a new Bluetooth device.
  - **Trusted Devices** to display a list of trusted Bluetooth devices.
  - **My Bluetooth Info** to display your phone's Bluetooth name, address, class, and supported profiles.

## Pair Bluetooth Devices

The Bluetooth pairing process allows you to establish trusted connections between your phone and another Bluetooth device. When devices are paired, a passkey (PIN) is shared between devices, allowing for fast, secure connections while bypassing the discovery and authentication process.

1. Press **OK** > **Tools** > **Bluetooth** > **Add New**.
2. Select the device you wish to pair with and press **OK**.

3. Enter the passkey and press .
4. (Optional) Edit the device name and press **SAVE** (left softkey).

**Note:** Due to different specifications and features of other Bluetooth compatible devices, display and operations may be different, and functions such as transfer or exchange may not be possible with all Bluetooth compatible devices.

## *Trusted Devices List*

This list displays a list of devices which are paired with your device and set as trusted devices.

[View the Trusted Devices List](#)

[Trusted Devices List Menu](#)

### *View the Trusted Devices List*

- ▶ Press  > **Tools** > **Bluetooth** > **Trusted Devices**.

### *Trusted Devices List Menu*

Once you have created trusted devices, several options are available from the Trusted Devices list.

#### *Left Softkey Menus*

1. Press  > **Tools** > **Bluetooth** > **Trusted Devices**.
2. Highlight a device, and press the available left softkey option:
  - **CONNECT...** to connect to the selected Bluetooth device, if not connected (for headsets, hands-free and other devices, excluding computers, PDAs, phones, or printers).
  - **TRANSFER...** to send data saved on your phone to the selected Bluetooth device (for computers, PDAs, or phones). (See [Send Items via Bluetooth](#).)
  - **PRINT...** to print picture using the selected Bluetooth-enabled printer. (See [Print Pictures via Bluetooth](#).)

#### *Options Menu*

1. Press  > **Tools** > **Bluetooth** > **Trusted Devices**.
2. Highlight a device, and press **OPTIONS** (right softkey) to display the following options:
  - **Add New** to add a new Bluetooth device.
  - **Delete** to delete the selected device from the list.

- **Delete All** to delete all devices from the list.
- **Auto-Accept** to configure your phone's accessibility to other Bluetooth devices.
- **View/Edit Info** to view or edit the information of the selected device.
- **Help** to display the Trusted Devices list help.

## *Send Items via Bluetooth*

Depending on your paired devices' settings and capabilities, you may be able to send pictures, Contacts information, or other items using a Bluetooth connection.

1. Press  > **Tools** > **Bluetooth** > **Trusted Devices**.
2. Select a device from the Trusted Devices list and press **TRANSFER...** (left softkey).
3. Highlight an item (**Contacts**, **Photos**, **Music**, **Files**, or **Calendar Events**) and press .
4. Follow the onscreen instructions to select items to send.
5. Read the message and press **SEND** (left softkey).

## *Print Pictures via Bluetooth*

You can print out your pictures stored on your phone. (Some Bluetooth-enabled printers may not support this feature.)

1. Press  > **Tools** > **Bluetooth** > **Trusted Devices**.
2. Select a printer from the Trusted Devices list and press **PRINT...** (left softkey).
3. Select the check box for each picture you wish to print and press **CONTINUE** (left softkey).

- or -

1. Press  > **Photos** > **My Photos**.
2. Highlight a picture to print and press **OPTIONS** (right softkey) > **Print** > **Bluetooth**.
  - Press **OPTIONS** (right softkey) > **Select Multiple** to select multiple pictures.
3. Select a printer.

**Note:** You may not be able to print pictures that you cannot display on your phone.

4. Set the print settings using your navigation key.

- **Type:** You can select the print mode from **Prints** or **Index**.
  - **Copies:** You can set the number of copies from **Single**, **Doubles**, or **Manual** (up to 99 per picture).
  - **Size:** You can set the print size from **4"x6"**, **5"x7"**, or **Letter**. (Print sizes may vary according to the type of printer you have.)
  - **Date:** You can imprint the date on your pictures. Select **On** or **Off**. (Date stamping may not be available depending on the type of printer you have.)
  - **Border:** You can choose whether to print the pictures with or without a border. Select **On** or **Off**.
  - **Caption:** You can choose whether to print the pictures with or without text captions such as the date captured (if available) and serial numbers. Select **On** or **Off**.
5. When you have finished selecting the print settings, press **PRINT** (left softkey).

**Note:** Before using the Bluetooth printing feature, make sure your phone's battery is fully charged.

# Web and Data Services

---

Your phone's data capabilities let you wirelessly access the Internet.

[Get Started With Data Services](#)

[Download Games, Ringers, and More](#)

[Browser Menu](#)

## Get Started With Data Services

With your Sprint service, you are ready to start enjoying the advantages of data services. This section will help you learn the basics of using your data services, including managing your user name, launching a data connection, and navigating the Web with your phone.

[Your User Name](#)

[Launch a Web Connection](#)

[Data Connection Status and Indicators](#)

[Learn to Navigate the Web](#)

### Your User Name

When you buy your phone and sign up for service, you're automatically assigned a user name, which is typically based on your name and a number, followed by "@sprintpcs.com." (For example, the third John Smith to sign up for data services might have jsmith003@sprintpcs.com as his user name.)

When you use data services, your user name is submitted to identify you to the Nationwide Sprint Network. Your user name will be automatically programmed into your phone. You don't have to enter it.

#### Find Your User Name

If you aren't sure what your user name is, you can easily find it on your phone.

▶ Press  > **Settings** > **Phone Info** > **Phone#/User ID**.

#### Update Your User Name

If you choose to change your user name and select a new one online, you must then update the user name on your phone.

- ▶ Press  > **Settings** > **Others** > **Data Settings** > **Update Data Profile**. (To cancel, press  before completing the update.)

## *Launch a Web Connection*

- ▶ Press  > **Web**. (Your data connection starts and you see the SprintWeb™ home page.)

**Note:** If Net Guard is enabled and displayed (see [Net Guard](#)), press **YES** (left softkey) to continue and launch the Web.

While connecting, you may see an animation before the home page appears.

**Tip:** To change the default launch page to the last page you viewed, press **TOOLBAR** (right softkey) and select **OPTIONS** > **Browsing options** > **Startup page** > **The last page I viewed** > **DONE** (left softkey).

## *Data Connection Status and Indicators*

Your phone displays the current status of your data connection through indicators at the top of the screen. The following symbols are used:



Your phone is connected to the Sprint 1xRTT data network. When the triangles are animated, your phone is transferring data (for example, when you are opening a Web page) and you cannot receive calls. When the triangles are solid gray, your phone is connected to the network but is not currently transferring data (for example, when you are viewing a Web page that is completely open), or is signed out of or disconnected to the network within the data service area, and you can receive calls.

If you do not see an indicator, your phone does not have a current data connection. To launch a connection, see [Launch a Web Connection](#).

## *Learn to Navigate the Web*

Navigating through menus and websites during a data session is easy once you've learned a few basics.

**Note:** Before you access the SprintWeb™ home page, you may be asked to enter your 10-digit wireless phone number and press . Entering your phone number is not required for access to other Web pages.

## *Softkeys*

During a data session, the bottom line of your phone's display screen contains one or more softkeys. These keys are shortcut controls for navigating around the Web, and they correspond to the softkeys directly below the phone's display screen.

**Tip:** Depending on which websites you visit, the labels on the softkeys may change to indicate their function.

To use softkeys:

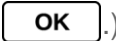
- ▶ Press a softkey. (If an additional pop-up menu is displayed when you press the softkey, select the menu items using your keyboard [if they're numbered], or by highlighting the option and pressing .)

### *Scrolling*

As with other parts of your phone's menu, you'll have to scroll up and down to see everything on some websites.

To scroll line by line through websites:

- ▶ Press the navigation key up or down.

### *Selecting*

Once you've learned how to use softkeys and scroll, you can start navigating the Web.

To select onscreen items:

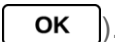
- ▶ Use the navigation key to highlight an item, and then press the left softkey (or press ).

**Tip:** You'll find that the left softkey is used primarily for selecting items. This softkey is often labeled "VIEW."

**Tip:** If the items on a page are numbered, you can use your keyboard (number keys) to select an item.

Links, which are displayed as underlined text, allow you to jump to Web pages, select special functions, or even place phone calls.

To select links:

- ▶ Highlight the link and press the appropriate softkey.

### *Go Back*

To go back one page:

- ▶ Press  on your phone.

**Tip:** You can also use  for deleting text (like a BACKSPACE key) when you are entering text.

## Go Home

To return to the home page from any other page:

- ▶ Press and hold .

- or -

Press **TOOLBAR** (right softkey) > **MY HOMEPAGE**.

## Download Games, Ringers, and More

You have access to a dynamic variety of downloadable content, such as Games, Screen Savers, and other applications. (Additional charges may apply.) Follow the basic steps in this section to access and download these items.

### Access the Download Menus

1. Press  > **My Stuff**.
2. Select a download category (**Games**, **Ringers**, **Screen Savers**, or **Applications**), and then select **Get New**.

- or -

Select **Call Tones**. (The browser will start and take you to the corresponding download menu.)

- or -

1. From the SprintWeb™ home page, select **Downloads**, and then select **Sprint Downloads**.
2. Select a download category (**Call Tones**, **Games**, **Ringers**, **Screen Savers**, or **Applications**) to go to the corresponding download menu. (For more information on navigating the Web, see [Learn to Navigate the Web](#).)

### Select an Item to Download

You can search for available items to download in a number of ways:

- **Featured** displays a selection of featured items.
- **Categories** allows you to narrow your search to a general category. (There may be several pages of available content in a list. Select **Next 9** to view additional items.)
- **Search** allows you to use your keyboard to enter search criteria to locate an item. You may enter an entire word or title or perform a partial-word search.

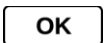

## Download an Item

Once you've selected an item you wish to download, highlight it and press . You will see a summary page for the item including its title, the vendor, the download details, and the cost. Links allow you to view the **License Info** page, which outlines the price, license type, and length of license for the download, and the **Terms of Use** page, which details the Premium Services Terms of Use and your responsibility for payment.

To download a selected item:

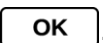
1. From the information page, use your navigation key to move the cursor over **Buy**. When the cursor changes from an arrow into a hand, press . The item will download automatically. When you see the **NEW DOWNLOAD** screen, you have successfully downloaded the item to your phone. (When you download a call tone, you will not see the **NEW DOWNLOAD** screen. Instead, you will see a screen giving you the option to set the downloaded call tone as your default.)

**Note:** If you have not previously purchased an item, you will be prompted to create your purchasing profile.

2. Select an option to continue:
  - Select a menu such as **Run/Open/Listen/View/Play** to start the downloaded item. Your data session will end, and your phone will redirect you to the appropriate phone menu screen.
  - Select **Assign** to assign a ringer or screen saver to a phone function.
  - Select **Settings** to configure downloaded games or applications.
  - Select **Shop** to browse for other items to download.
  - Press  to quit the browser and return to standby mode.

## My Content Manager



Whether you purchase your content from your phone or from your online account management page at [www.sprint.com](http://www.sprint.com), **My Content Manager** stores all of your purchases and you may download them to your phone from there.

**My Content Manager** is a storage area on the Nationwide Sprint Network that allows you to store all your purchased files. The files remain in My Content Manager until their license terms have expired – even after you have downloaded the content to your phone. This provides you with a convenient place to access information about your downloaded files without having to store the information in your phone's memory.

To access My Content Manager:

1. From the SprintWeb™ home page, select **Downloads > Sprint Downloads > My Content Manager**. (You will see a list of download categories.)
2. Highlight a category and press . (You will see your downloads for that category.)

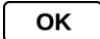
To download purchased content from My Content Manager:

1. From the **My Content Manager** display, highlight the item you wish to download, and press . (You will see the information page for the selected item.)
2. Highlight **Download** and press . The item will download automatically. When you see the **NEW DOWNLOAD** screen, you have successfully downloaded the item to your phone. (When you download a call tone, you will not see the **NEW DOWNLOAD** screen. Instead, you will see a screen giving you the option to set the downloaded call tone as your default.)
3. Select an option to continue:
  - Select a menu such as **Run/Open/Listen/View/Play** to start the downloaded item. Your data session will end, and your phone will redirect you to the appropriate phone menu screen.
  - Select **Assign** to assign a ringer or screen saver to a phone function.
  - Select **Settings** to configure downloaded games or applications.
  - Select **Shop** to browse for other items to download.
  - Press  to quit the browser and return to standby mode.

**Tip:** You can also access My Content Manager through the phone's main menu. Go to **My Stuff > [Games, Ringers, Screen Savers, or Applications] > My Content Manager**. The browser will open and take you to the corresponding content.

For complete information and instructions on downloading **Games, Ringers, Screen Savers, and Applications**, visit the Digital Lounge at [sprint.com](http://sprint.com).

## *Browser Menu*

Although the SprintWeb™ home page offers a broad and convenient array of sites and services for you to browse, not all sites are represented, and certain functions, such as going directly to specific websites, are not available. For these and other functions, you will need to use the browser menu. The browser menu offers additional options to expand your use of the Web on your phone.

## Open the Browser Menu

You may open the browser menu anytime you have an active data session, from any page you are viewing.

To open the browser menu:

- ▶ Press **TOOLBAR** (right softkey). (You will see the browser menu.)

Options available under the browser menu include:

- **BACK** to go back to the previous Web page.
- **FORWARD** to move to a previously viewed page (after having used **BACK** or ).
- **MY HOMEPAGE** to return the browser to the home page.
- **MY PAGES** to access and manage your favorites (bookmarks).
- **SPRINT SEARCH** to launch a Web search.
- **OPTIONS** to display additional options:
  - **Set as Homepage** to set the current page as your home page.
  - **Send this page to...** to send a URL using the phone's messaging feature.
  - **Clear private data** to delete the browser's cache, cookies, etc.
  - **Browsing options**
    - **Startup page** to change the default launch page.
    - **Automatic overview mode** to use the automatic overview mode.
    - **Images** to display images on the Web page.
    - **Virtual mouse** to use the virtual mouse.
  - **Help** to show more detailed information about using the browser.
  - **Advanced**
    - **Icon Row** to display or hide the area showing icons.
    - **Page info** to display information about the current page.
    - **Certificates** to show the certification.
    - **Java Scripting** to enable or disable Java scripting.
    - **Redirect prompt** to display a prompt when your data is being redirected.

- **Send referrer** to send HTTP URL referrer information.
- **Turn on error logging / Turn off error logging** to set whether to save error logs (text files useful for debugging browser errors). To display the error log, select the **View error log** option from the submenu (available only when the error log is enabled).
- **Reset browser settings** to reset all browser settings.
- **Reset browser** to reset the browser to its default state.
- **About browser** to display information about your browser.

### *Go to a Specific Website*

To go to a particular website by entering a URL (Web address):

1. From any Web page, press the navigation key up to highlight the address bar.
2. Use your keyboard to enter the URL of the website you wish to go to and press .

**Note:** Not all websites are viewable on your phone.

### *Create a Favorite*

Favorites (bookmarks) allow you to store the addresses of your favorite websites for easy access at a later time.

1. From the Web page you wish to add, press **TOOLBAR** (right softkey) to open the browser menu.
2. Select **MY PAGES**.
3. Select **Add this page to favorites**.
4. Press **ADD** (left softkey).

**Note:** Saving a page as a favorite does not store the page contents, just the page's address.

**Note:** Some pages cannot be saved as favorites, depending on how a particular page was created.

### *Access a Favorite*

1. Press **TOOLBAR** (right softkey) to open the browser menu.
2. Select **MY PAGES**.
3. Select a favorite and press .

### *Delete a Favorite*

1. Press **TOOLBAR** (right softkey) to open the browser menu.
2. Select **MY PAGES**.
3. Highlight a favorite and press **OPTIONS** (right softkey).
4. Select **Delete this Favorite**. (A confirmation will be displayed.)

**Tip:** Select **Delete All Items** to delete all favorites.

5. Press **REMOVE** (left softkey) and then press  to remove the favorite.

### *Reload a Web Page*

- ▶ Press  while the Refresh icon () at the upper right corner of the browser is highlighted.

# GPS Features

---

Your phone's built-in GPS capability gives you access to a number of location-based services.

## Location Mode



### Sprint Family Locator

## Location Mode

Before using any of the location-based services, you must turn on your phone's location mode.

To enable your phone's Location feature:

1. Press  > **Settings** > **Others** > **Location** > **On/Off**. (You will see the Location disclaimer.)
2. Read the disclaimer and press .
3. Select **On**.

When the Location feature is on, your phone's standby screen will display the  icon. When Location is turned off, your phone will display the  icon.

To send the GPS log to other devices:

1. Press  > **Settings** > **Others** > **Location** > **NMEA Output**.
2. Select **Bluetooth** or **USB**.

**Note:** Turning Location on will allow the network to detect your position using GPS technology, making some Sprint applications and services easier to use. Turning Location off will disable the GPS location function for all purposes except 911, but will not hide your general location based on the cell site serving your call. No application or service may use your location without your request or permission. GPS-enhanced 911 is not available in all areas.

## Sprint Family Locator

Sprint Family Locator uses GPS technology to locate your child's phone and display the location on an interactive map.

**Note:** Sprint Family Locator service requires an additional monthly fee. Visit [sprint.com/familylocator](http://sprint.com/familylocator) for complete details.

[Sign Up for Sprint Family Locator](#)

## Use Sprint Family Locator

### *Sign Up for Sprint Family Locator*

1. Press  > **Sprint Family Locator**.
2. Follow the onscreen instructions to enter and submit the required information.

**Note:** You can also sign up for Sprint Family Locator online at [sprint.com/familylocator](http://sprint.com/familylocator).



### *Use Sprint Family Locator*

1. Press  > **Sprint Family Locator**.
2. Enter the parent phone number and password to sign in to your account.
3. Select a phone to locate from the available child phone list.
4. When you are finished, select **Sign Out**.

**Note:** You may also use Sprint Family Locator with any computer with an Internet connection. Visit [sprint.com/familylocator](http://sprint.com/familylocator) for complete details.

# Copyrights

---

- ©2011 Sprint. SPRINT and the logo are trademarks of Sprint. KYOCERA is a registered trademark of Kyocera Corporation. Other marks are the property of their respective owners.
- This product contains NetFront Browser of ACCESS CO., LTD.. ACCESS and NetFront are trademarks or registered trademarks of ACCESS CO., LTD. in Japan and other countries. This software is based in part on the work of the Independent JPEG Group.
- The Bluetooth word mark and logos are owned by the Bluetooth SIG, Inc. and any use of such marks by Kyocera Corporation is under license. Other trademarks and trade names are those of their respective owners.
- XT9® is a registered trademark of Nuance Communications, Inc. and its affiliates in the United States and other countries. Copyright © 2011 Nuance Communications, Inc. All rights reserved.
-   microSD and microSDHC Logos are trademarks of SD-3C, LLC.



# Index

---

- 3-Way Calling, 32
- Abbreviated Dialing, 28
- Activation, 3
- Airplane Mode, 34
- Alarm, 85
- Answer Phone Calls, 23
- Applications
  - Download, 104
- Auto-Answer, 33
- Automatic Speech Recognition (ASR), 80
- Backlight, 37
- Battery
  - Capacity, 14
  - Charge, 15
  - Install, 2
- Bluetooth
  - Pair Bluetooth Devices, 97
  - Print Pictures, 99
  - Send Items, 99
  - Turn Bluetooth On and Off, 96
- Browser Menu, 106
- Calculator, 86
- Calendar
  - Add a To Do List Item, 71
  - Add an Event, 70
  - Calendar Alerts, 72
  - Delete Events, 72
  - View Events, 72
- Call
  - Answer, 23
  - End, 24
  - Forward, 32
  - Make, 22
- Call Answer Mode, 33
- Call Waiting, 31
- Callback Number, 42
- Caller ID, 31
- Camera
  - Print Pictures, 94
  - Send Pictures, 93

- Store Pictures, 91
- Take Pictures, 88
- Clock
  - Display, 38
  - World Clock, 86
- Contacts
  - Add an Entry, 57
  - Assign a Picture, 62
  - Assign a Speed Dial Number, 61
  - Delete an Entry, 59
  - Dial From, 27
  - Edit an Entry, 57
  - Find Entries, 60
  - Secret Entries, 62
- Countdown Timer, 87
- Data Services
  - Enable/Disable, 50
  - Get Started With, 101
  - Launch, 102
  - Password, 5
  - Security Features, 50
  - User Name, 101
- Delete Phone Content, 49
- Dial
  - From Contacts, 27
  - With Pauses, 27
- Display Settings, 36
- Download, 41, 104
- DPOF, 78
- Email
  - Access, 68
  - Get Started With, 67
- Emergency Call, 24
- Enter Text, 16
- Favorite, 108
- File Manager, 77
- Find
  - Contacts, 60
  - Phone Number, 26
- Font Size, 38
- Games
  - Download, 104
- GPS Features, 110
- Greeting, 38

- Headset, 33
- Hearing Aid Device Compatibility, 35
- History
  - Make a Call From, 54
  - Make a New Group Entry, 54
  - Options, 53
  - Save a Number From, 54
  - View, 52
- Icon indication, 10, 53, 96, 102
- Key Functions, 8
- Keyguard, 10
- Language
  - Display, 39
  - Preset Messages, 43
- Location, 110
- Lock Code, 47
- Lock Phone, 47
- Make Phone Calls, 22
  - From Contacts, 27
  - From History, 54
  - Using ASR, 81
- Messaging, 64
  - Long Message Reassembly, 44
  - Repeated Tone, 44
  - Settings, 42
  - Thread, 65
- microSD Card, 73
  - Format, 76
- Missed Calls, 24
- Multiple Shots, 90
- My Content Manager, 105
- Net Guard, 51
- Parental Controls, 48
- Phone (illus.), 8
- Phone Number
  - Display, 16
  - Find, 26
  - With Pauses, 27
- PictBridge, 94
- Pictures
  - Assign, 89
  - Store, 91
  - Take, 88
- Plus (+) Code Dialing, 28

- Power Save Mode, 38
- Preset Messages, 43
- QWERTY Keyboard, 17
- Reset, 50
- Ringers
  - Download, 41, 104
- Roaming, 44
- Save
  - Number From History, 54
- Security, 46
- Self-timer, 90
- Signature, 43
- Speed Dialing, 28
  - Assign Numbers, 61
- Sprint Family Locator, 110
- Sprint Service
  - Account Passwords, 5
  - Dial, 63
  - Operator Services, 6
  - Sprint 411, 6
- Stopwatch, 87
- TTY Use, 34
- Turn Your Phone On and Off, 14
- Unlock Your Phone, 47
- User Name, 101
- Vibration, 42
- Voice Guide, 41
- Voice Memos, 83
- Voicemail
  - Retrieve, 30
  - Set Up, 4, 29
  - While Roaming, 45
- Web
  - Browser Menu, 106
  - Download Contents, 104
  - Get Started With, 101
- World Clock, 86
- Zoom, 91