



---

---

Service Manual  
for Typhoon

---

---

HTC Proprietary  
Confidential Treatment Requested

**Rev. A04**  
SEPT 20, 2004

**HTC Corp.**  
*Engineering Mobility*





---

## Table of contents

<b>Chapter 1 - Introduction</b>	<b>5</b>
1.1 History	5
<b>Chapter 2 - Product Specifications</b>	<b>6</b>
<b>Chapter 3 - Servicing Tools</b>	<b>8</b>
<b>Chapter 4 - Assembling and Disassembling</b>	<b>9</b>
<b>4.1 Disassembling</b>	<b>9</b>
<b>4.2 Assembling</b>	<b>18</b>
<b>4.3 MB Pre-Assembling</b>	<b>24</b>
<b>4.4 LCD Pre-Assembling</b>	<b>25</b>
<b>Chapter 5 - Diagnostic Programs</b>	<b>26</b>
<b>5.1 List of Test Items (Diagnostics in SD card)</b>	
<b>5.2 Test Procedure</b>	
<b>5.3 Test Result</b>	
<b>Chapter 6 - Battery Test Procedure</b>	<b>29</b>
<b>6.1 Leakage current measurement with Fixture</b>	
<b>6.2 Battery Capacity Test</b>	
<b>Chapter 7 - Software Upgrade procedure</b>	<b>34</b>
<b>7.1 Software upgrade</b>	
<b>7.2 Smartphone Reset</b>	
<b>7.4 Software Backup to SD card</b>	
<b>Chapter 8 - RF Antenna test spec andf criteria</b>	<b>42</b>
<b>8.1 Antenna Test Specification</b>	
<b>8.2 Antenna Test Criteria</b>	



---

<b>Chapter 9 - Inspection Criteria</b>	<b>45</b>
<b>9.1 Definition</b>	
<b>9.2 Inspection Area</b>	
<b>9.3 Criteria</b>	
<b>Chapter 10 - Trouble Shooting</b>	<b>46</b>
<b>Chapter 11 - Labeling Plan</b>	<b>53</b>
<b>Chapter 12 - Exploded Diagram &amp; Spare parts list</b>	<b>54</b>
<b>12.1 Spare parts list for repair</b>	
<b>12.2 Accessory Spare parts list</b>	
<b>12.3 Board level parts list</b>	
<b>Chapter 13 - Board Level Repair</b>	<b>57</b>
<b>13.1 Components to be Replaced</b>	
<b>13.2 Problem Identification &amp; Troubleshooting</b>	



## Chapter 1 - Introduction

This manual provides the technical information to support the service activities of Typhoon. It contains highly confidential information, so any or all of this document should not be revealed to any third party.

### 1.1 History

Reversion	Update item	Pages effected
A01	First release	N/A
A02	Spare part list, exploded diagram, parts picture	Page 51,52
A03		Page 16&17 ,(Speaker ,Camera dis-assembly part and receiver tape),P56 (LCD connector)
A04	Add RF spec	



## Chapter 2 - Product Specifications

Function	Specification
Platform	<ul style="list-style-type: none"> <li>● Microsoft Smart Phone 2003</li> </ul>
Dimensions	<ul style="list-style-type: none"> <li>● 107.54 (L) x 46.2 (W) x 17.5 (T) mm</li> </ul>
Weight	<ul style="list-style-type: none"> <li>● 100g with battery</li> </ul>
CPU	<ul style="list-style-type: none"> <li>● TI OMAP 730</li> </ul>
Memory	<ul style="list-style-type: none"> <li>● SDRAM : 32MB</li> <li>● Flash ROM : 64MB</li> </ul>
GSM Function	<ul style="list-style-type: none"> <li>● Tri-band 900/1800/1900</li> <li>● GPRS, Class B</li> <li>● Multi-slot class 10</li> </ul>
Display	<ul style="list-style-type: none"> <li>● 2.2 inch, 176x220 dots resolution</li> <li>● 64K colors TFT Transflective LCD</li> <li>● Dot Pitch : 66um x 198 um</li> <li>● LED back Light</li> </ul>
Keyboard/Button	<ul style="list-style-type: none"> <li>● One Power Button (On the Top)</li> <li>● One Numeric Dialing Keypad(12 buttons)</li> <li>● Two soft key button</li> <li>● One Home/connection quick list button</li> <li>● One Back button</li> <li>● Send/Phone button</li> <li>● End Phone button</li> <li>● One 5- way navigation keypad</li> <li>● One Camera Capture button</li> <li>● Volume up button (Long Press as voice record)</li> <li>● Volume down button(long press as Voice command/Dial.</li> </ul>
Interface	<ul style="list-style-type: none"> <li>● 3.0 V SIM Card.</li> <li>● One mini-USB connector (Slave USB, Power IN)</li> <li>● One Infrared IrDA SIR.</li> <li>● One Mini SD memory card slot</li> <li>● One external antenna connector.</li> </ul>
Power	<ul style="list-style-type: none"> <li>● Rechargeable battery, Li-Ion 970 mAh</li> <li>● Talk : 3.5 ~ 4 hours</li> <li>● Standby : 140 hours</li> <li>● AC Adapter: <ul style="list-style-type: none"> <li>- AC input rating : 100 ~ 240 VAC, 50/60 HZ.</li> <li>- DC Output rating : 5VDC, 1 A.</li> </ul> </li> <li>● Ambient Light Sensor for LED power consumption</li> </ul>
Device to device connectivity	<ul style="list-style-type: none"> <li>● Bluetooth</li> <li>● Infrared IrDA SIR</li> <li>● USB mini-B plug and receptacle</li> </ul>
CMOS Camera	<ul style="list-style-type: none"> <li>● Color</li> <li>● Resolution: VGA</li> <li>● Min 5 Lux</li> <li>● Preview Mirror</li> </ul>



Notification	<ul style="list-style-type: none"><li>● One Bi-color LED (Green and Red) for GSM STANDBY, GSM standby, GSM network status, Event Notification, Power charging status.</li><li>● One Blue LED for Bluetooth connectivity status.</li><li>● Vibration for notification and Incoming call.</li><li>● Notification by LED, Sound, Message, Vibration Motor.</li></ul>
Accessories	<ul style="list-style-type: none"><li>● <b>Bundle:</b><ul style="list-style-type: none"><li>➤ AC adapter w/ DC_In mini USB plug</li><li>➤ USB Sync cable</li><li>➤ Stereo wired headset with Microphone</li><li>➤ Standard Battery</li><li>➤ User Manual, Quick Start Guide, Sync. Software CD</li></ul></li><li>● <b>Option</b><ul style="list-style-type: none"><li>➤ Car Adapter</li><li>➤ Traveler Charger with back up battery charging slot</li><li>➤ Car kit with Car Stereo Mute function</li><li>➤ Carrying case</li></ul></li></ul>



## Chapter 3 - Servicing Tools

This chapter provides information for the servicing tools for Typhoon.

### List of Servicing Tools

No.	Item	Use	Remark
1	Disassembly tools	Plastic stick for dismantle the unit Cleaning wipers Precision screw driver 0.9mm Philips Screw driver Protective Film Tweezers Air Gun <b>Clean Bench (Mandatory)</b>	
2	Mini USB cable	For Synchronization Test	
3	Mini SD Memory Card	For SD card test	
4	Headset	For Hand free / Recording test	
5	AC Adapter with DC In mini USB plug	Power supply to Typhoon	
6	Diagnostic Test Program	Test Program for Functional Test	
7	Software Upgrade tools	For software version upgrade or re-flash	
8	Label Printer & Scanner	For Printing & Scanning regulation label when housing or M/B is changed.	
9	Battery Test Jig	For Main Battery judgement	





## Chapter 4 - Assembling and Disassembling

### 4.1 Disassembling

	<p>Tools needed for Assembling and Disassembling the Smart Phone</p> <ol style="list-style-type: none"> <li>1. Glove &amp; Lens Cleaning Tissue.</li> <li>2. Plastic type tweezers.</li> <li>3. Philip Screw Driver #0.</li> <li>4. Philip Screw Driver type T5</li> <li>5. Precision driver flat(θ) type 0.9 mm</li> <li>6. Special Made Plastic Stick</li> </ol>
	<p>Disassembly process Front side</p>
	<p>Rear Side</p>
	<p>Remove antenna rubber, battery cover, battery from unit</p>



To remove antenna cover  
Please use Precision driver flat( $\theta$ ) type 1.2 mm and insert in to the two hole as shown on picture.  
**Insert in angle:30 °**

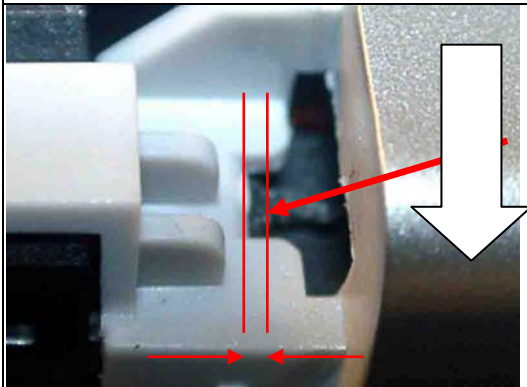

**TIPS:**  
Insert the driver to the hole with angle about 30 degree , after reach the end, move back around 1mm and press it down to release the the cover lock.

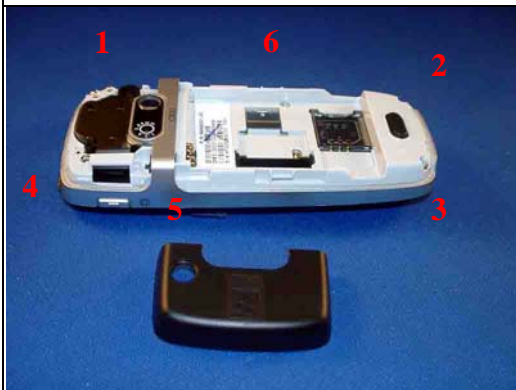

1. Remove the cover from its place.
2. Unscrew 6 ea screws which fix rear cover to front panel.



Next, start disassembly the rear cover.  
Please be noticed that improper way of disassembly may caused the cover worn easily

1. Insert the plastic stick to the gap between front and rear cover deep inside.
2. **Move the stick slightly from lower side to upper to release the 6 hooks (3 each at both side)**



Release all hooks at both side.



Remove the rear cover

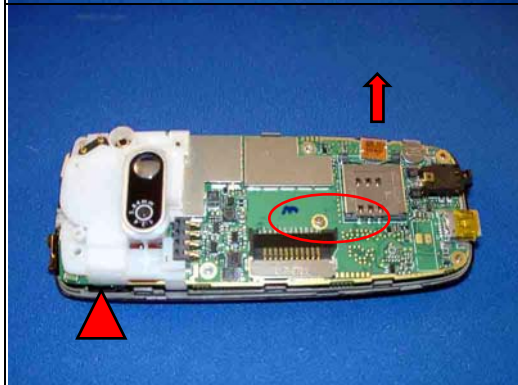

Next remove one screw which fix the MB to front case.  
Following to release the LCD FPC .

To take out the upper half part, hold the MB **together with** the LCD at the upside part near antenna



MB+LCD have been remove from front panel.  
Please keep the LCD at clean surface.



Next, release the Speaker+ Camera module from MB by releasing three holder at its right, left and top side.



Camera is pre-assembled together with Speaker module.

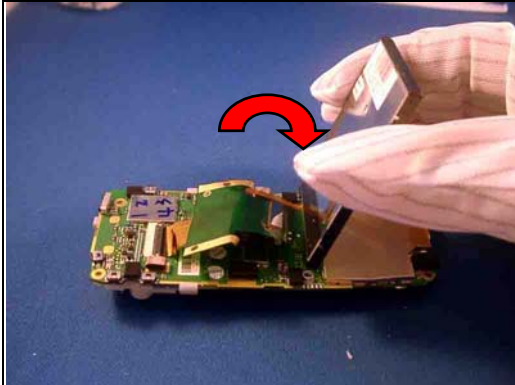

Next, remove the LCD from MB. Please notice that there are two double sides tape stuck between LCD and its FPC.

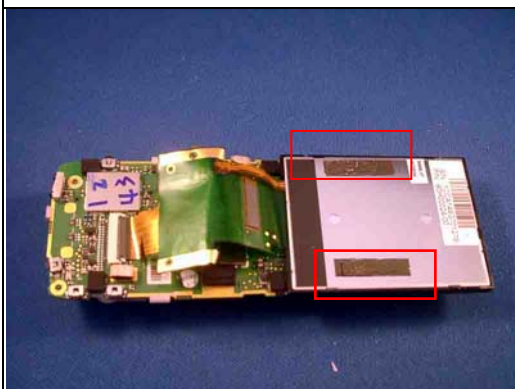

These two tapes are reusable for assembly.

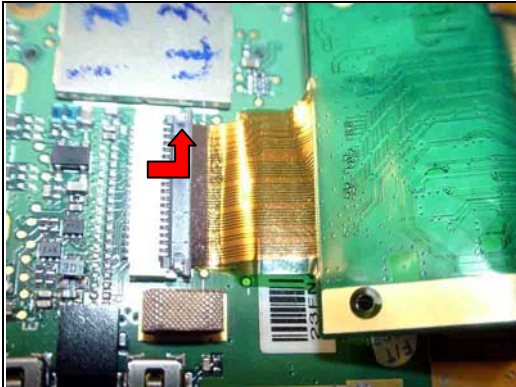

Release the LCD Connector cover to remove the LCD from its connector by pulling upward.

Put the LCD to clean and safe place.

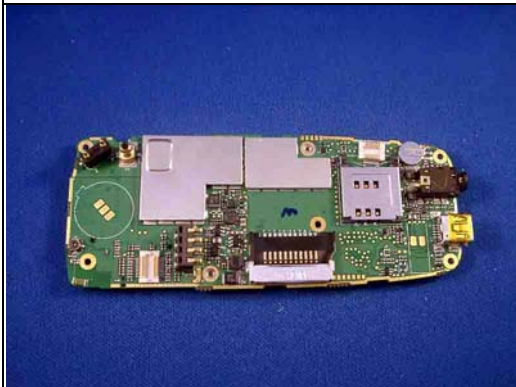

Now MB is separated from LCD



Continue with Front panel disassembly

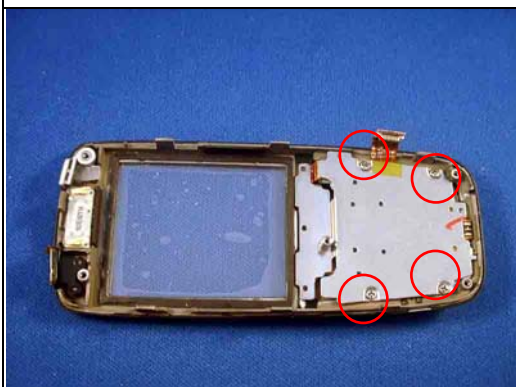

Disassembly the switch board.

1. Release four screws which tighten the switch board to front panel.
2. Take out the switch board.

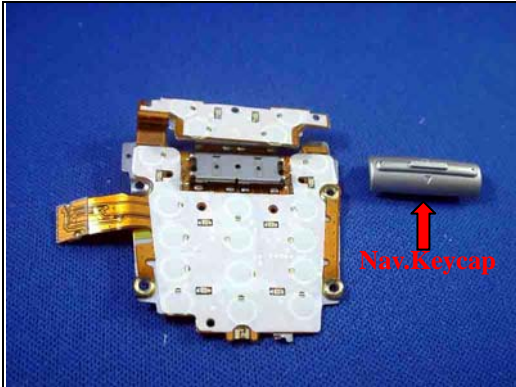

Remove the **numeric keypad, function keypad** and **Navigation keycap** from the switch board.



Remove the numeric keypad from the front panel.



**Numeric keypad**



**Functional keypad**

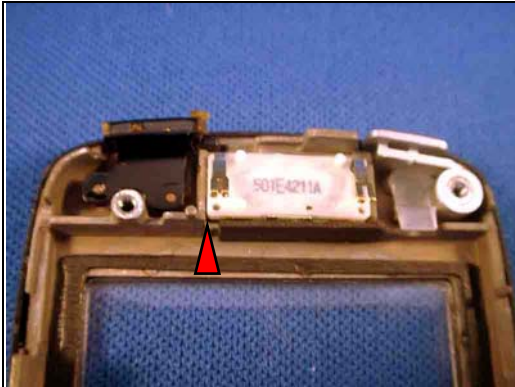

To disassembly receiver  
Slightly release it from its lower left part.



Remove the Vibrator from its place.



Take out and put on safe place.



Please be noticed since Camera, mirror and camera lens is **assembled together** with speaker module, once speaker is confirmed defective and need to be replaced, it could be replaced directly as shown on next picture.

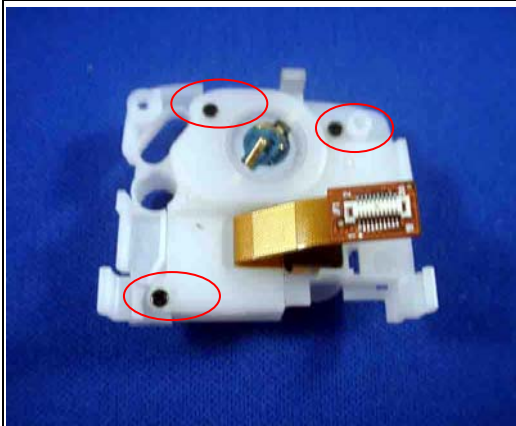

Remove the speaker by releasing the three screw to release its top cover.

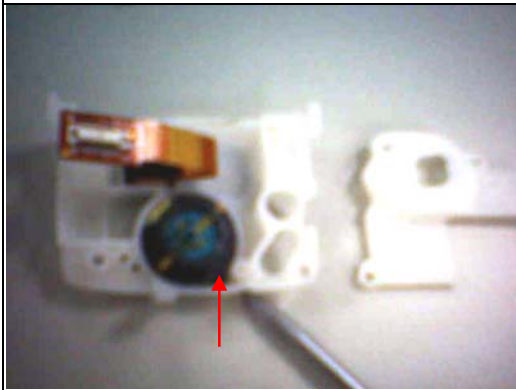

Its top cover is sticked by tape, remove the tape.  
Take out the speaker from direction shown on picture.



In case of camera defective, **Donot remove** it directly from this side.

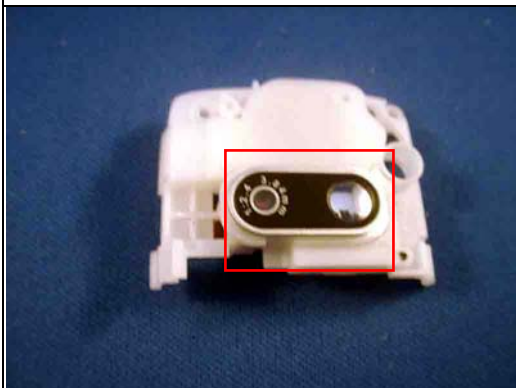

Need to remove the camera lens in advance and then push out the camera from this side using soft stick such as pencil eraser .

**Note:** Please protect the key part such as LCD, camera, MB in appropriate box/packing before sending as RTV part. Fail to do so, may cause such parts treated as OOW.





Remove the camera lens in advance.



Use soft tool such as stylus to push out the camera



CMOS camera.

If you send this part as RTV(return to vendor), please protect (pack) it in appropriate way , otherwise broken parts will be treated as OOW



In this case, need to replace the camera lens with new one to finish the assembly.

**Disassembly process is Done.**



## 4.2 Assembly Process



Assembly vibrator into its place on rear cover.

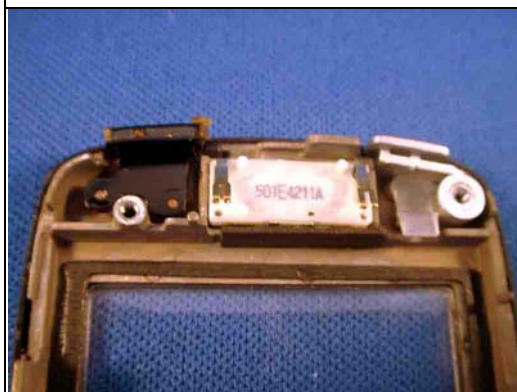

**Assemble** Receiver into its place, notice the two pin should not bent on assembly process.

**Notice:** Receiver coming as spare part already has double side tape on it, you could remove the top layer and stick it on front panel.



Assemble the numeric keypad.

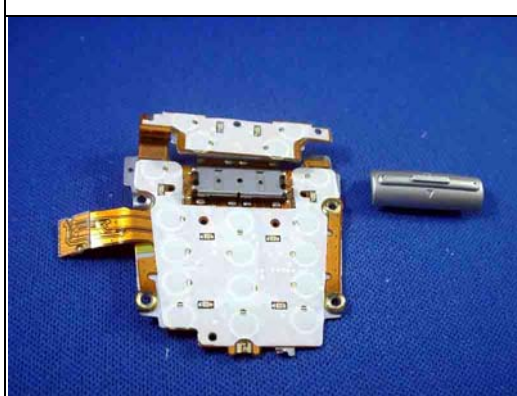

Put the Navigation keycap, functional keypad and switch board into front panel.



Fasten four screws to fix switch FPC board with its metal support.  
Notice the two guide points is fixed.

**Torque:  $0.5 \pm 0.1$  kgf-cm**

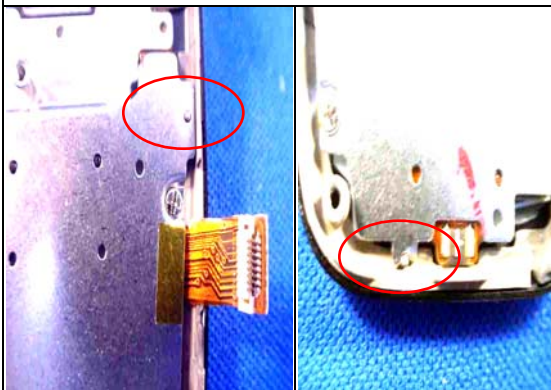

Besides of above two guide pins, need to adjust additional two guide pins as shown on picture.

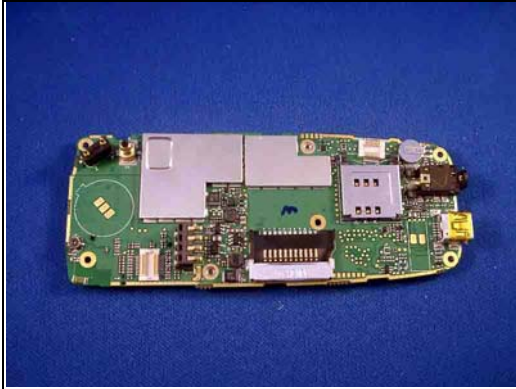

Next for MB part.

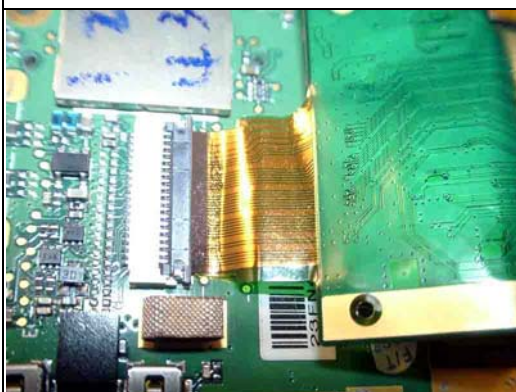

Insert the FPC into its connector.  
Please notice to align the first white line for type 1 LCD.

Second white line is for another type LCD.

**Remark: Make sure the LCD is installed properly.**

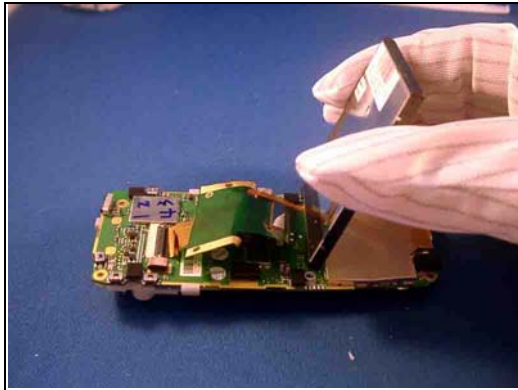

Place the LCD into its place

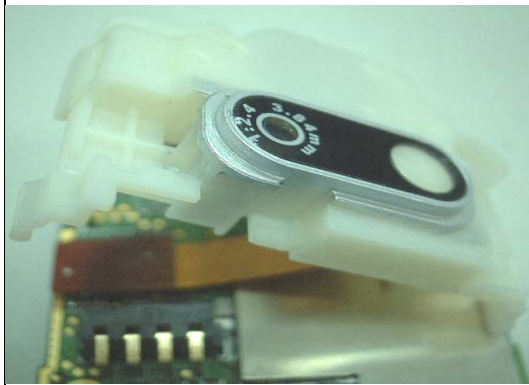

Assemble Speaker module to MB.

Please notice the camera FPC should be inserted properly into its place.



Make sure Speaker module's hook installed properly into MB.



Before assembly the front panel, please check the receiver pin is not deformed.

Hold the MB together with LCD into front panel. Please pay attention to Receiver PIN.

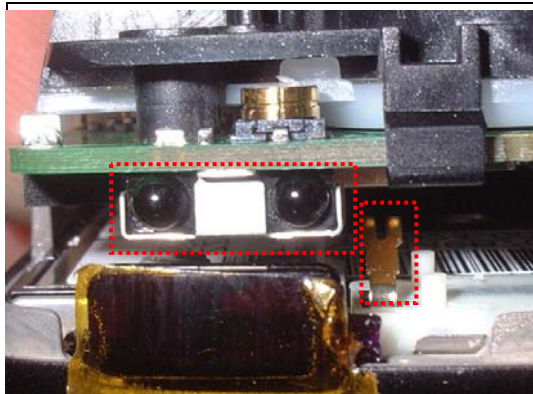

Please notice not to contract to receiver pin which may cause pin deformed.

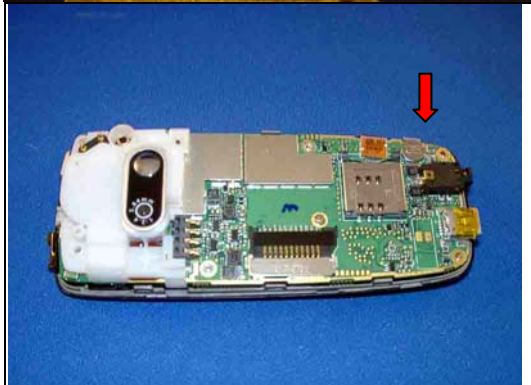

Place the MB into the front panel and adjust it to the guide hole at the lower right side, as the fix position reference  
Assemble the **Switch board FPC** connector.  
Fasten the screw which fix the MB to front panel.

**Torque:0.7±0.05 kgf-cm**



Now to assemble rear cover.



Starting from bottom part



Then assemble the rear cover along the unit, fix it to its hook.



Fasten four screws located on the upper & lower of unit.

**Torque:  $1 \pm 0.1$  kgf-cm**



Continue with antenna cover assembly



Installed the cover starting from upper part



Do remember to put Security label(warranty seal on the top of screw (right)



Install battery, battery cover, antenna rubber cover into unit



Lock the battery cover

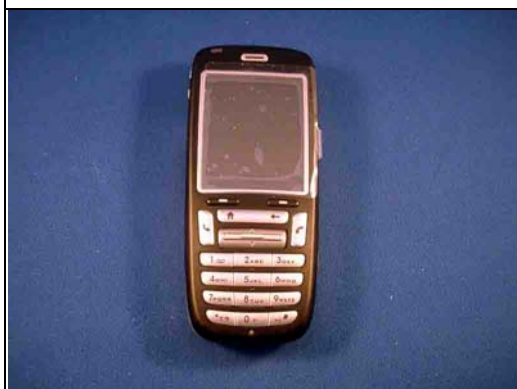

**Now unit is ready for functional test**

**Assembly process is DONE.**



### 4.3 MB Pre-assembly

Parts that need to pre-assembled first upon replacing to new one:

(1) Main board.

	<p><b>(A SIDE)</b></p> <p>There are 10 ea pre-assembly parts need to be added before assembled to unit:</p> <ol style="list-style-type: none"> <li>1. MIC Cover: 76h00598-00M( No 1)</li> <li>2. Poron, LCD supporter (qty:4) :76H00597-00 [2~6]</li> <li>3. Poron, LCD Ground,(qty 2), : 76H00596-00 [7~8]</li> <li>4. Gasket,U-tek : 76H00595-00 (QTTY: 2) ; [9 ~ 10]</li> </ol> <p><b>B-SIDE</b></p> <p>There are two parts need to be pre-assembled:</p> <ol style="list-style-type: none"> <li>1. EMI Gasket,72H00718-00</li> <li>2. Mylar for PCB drop, Part no: 76H00710-00</li> </ol>
--	---



Mylar for PCB \*2





#### 4.4 LCD Pre-assembly

##### On LCD

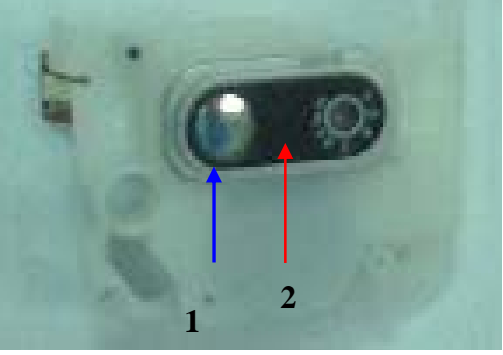
	<p>It is required to stick a tape (21*10mm) on LCD FPC to prevent short after assembly. P/N: 76H00671-00(MYLAR FOR LCD)</p>
	<p>It is stuck to the FPC which a lot of component on it.</p>
	<p>Speaker module. CMOS Camera module could be separated from speaker module .</p>
	<p>Pre assembled part to Speaker module:</p> <ol style="list-style-type: none"> <li>1. Mirror (74H00319-00)</li> <li>2. Camera lens (71H00824-00)</li> </ol>

**\*\*\* The Unit Assembly is done and ready for further tests.\*\*\***



## Chapter 5. Diagnostics Program

### 5.1 List of Test Item

- You will see HTC Copy right on the first page of Diagnostic program.
- Totally there are 24 items content of Diagnostic test.

No.	Item	Description	Remark
1	Pre- Test	Use as internal test station on HTC	HTC Use Only
2	RAM TEST	RAM Memory Test	
3	DISP TEST	LCD pattern display test	
4	LED Test	LED (BLUE/GREEN/RED/Key ) test	
5	Key Test	Keypad & soft-key pressing test	
6	Time Test	RTC timer test	
7	VIB. Test	Vibrator On/Off test	
8	B.L TEST	Back light Test	
9	SD TEST	SD card read / write test	
10	SPK PLAY	Test Speaker output	
11	REV Play	Test Receiver output	
12	HST play	Test headset output	
13	INT1~ SPK O	Internal MIC to Speaker output	
14	INT1~ REV O	Internal MIC to Receiver output	
15	INT1~ HSTO	Internal MIC to Headset output	
16	HSTI~HSTO	Headset input to Headset output	
17	LI Sensor	Light Sensor Test	
18	MS Format	RESET Phone to Default(Factory setting)	
19	DIAG 2 SD	HTC internal use	HTC Use Only
20	Batt Info	Show AC IN or Out and Battery info	
21	Unit Info	Show Unit Serial No and IMEI No.	
22	RUN IN	Perform RUN IN Test	
23	BatRunDwn	Battery Run Down Test	
24	Checksum	Checksum value check after Reflash	



Some items need to test under OS Mode			
25	USB TEST	Link with PC/Notebook to check USB Link function	
26	SIR Test	Infrared port test	Test with second unit
27	RS232 TEST	Link with PC/Notebook to check RS232 Link function	
28	Camera Test	Test Camera Function	
29	Bluetooth	Test Bluetooth function	

## 5.2 Test procedure

- (a) Power OFF.
- (b) Insert Diagnostic Mini SD card (provide by HTC) to Smartphone Unit
- (c) Set the Unit into Bootloader Mode ( Press & Hold **Capture**, then press **Power** button, then release power button first). Then press volume down button to download diagnostic to unit. Wait for “HTC logo” appears on screen, press **Action key** into Diagnostic test.
- (d) On test menu, use Navigation button to select the item then press Action key for testing, You could also use numeric key to select the test item. Use Right/Left to change to other page.
- (e) Remove the battery directly to exit the Diagnostic program when finish the testing.
- (f) If the system fails while testing, please also remove the battery directly to turn off power.

### IMPORTANT NOTICE:

1. Please do not leave the mini SD diagnostic card left on the unit while booting to Windows mode. Because mini sd card do not have lock mechanism, easily to be formatted accidentally.
2. Once the unit has been entering Windows mode (HOME SCREEN) , **the SD card might be formatted** already and once executing the diagnostic will stop on “ CHECKSUM ERROR “ without successfully entering the Diagnostic.
3. Once happen, you might need to ask HTC assistance for card replacement .

## 5.3 Test procedure and description



No.	Item	Description	Remark
1	RAM TEST	RAM Memory Test, Once finished test will show PASS and back to main Menu	Will stop once FAILED.
	DISP TEST	Press Action to change display mode	Press Action to change display mode
2	LED Test	LED ON for BLUE>GREEN>RED>Keypad	Press Action to NEXT
3	Key Test	Launch(capture)> Vol up> Vol dwn>soft1(Start )>Soft2(Contact )>Talk >Home >Back >End >UP > Right > Down >Left > Action > Numeric(1 ~ # )	Back to Main MENU automatically
4	Time Test	RTC timer test	Back to Main MENU automatically
5	VIB. Test	Select this item will activate Vibrator	Press Action to MENU
6	B.L TEST	Back light adjust from MAX >DIM > OFF	Press Action to MENU
7	SD TEST	Performing SD R/W test	Back to Main MENU automatically
8	CheckSum	Calculate checksum of Flash-ROM	Could be use for verifying after OS reflash
9	SPK PLAY	Select this item to check speaker	Back to Main MENU automatically
10	REV Play	Select this item to check Receiver quality	Back to Main MENU automatically
11	HST play	Select this item to check Headset function	Back to Main MENU automatically
13	INT1~ SPK O	Recording test via MIC > Speaker	Back to Main MENU automatically
14	INT1~ REV O	Recording test via MIC > Receiver	Back to Main MENU automatically
15	INT1~ HSTO	Recording test via MIC > Headset	Back to Main MENU automatically
16	HSTI~HSTO	Recording test headset	Back to Main MENU automatically
17	LI Sensor	Light Sensor Test	Put your finger into light sensor on bottom part of unit, under 0 keypad. Follow procedure on screen.
18	MS Format	RESET Phone to Default(Factory setting)	<b>For Refurbishment ONLY</b>
19	Batt Info	Show AC plug status & battery capacity(ref)	Press Action to exit
20	Unit Info	Show Unit Serial No and IMEI No.	Press " 0 " to exit
21	RUN IN	RUN IN Test with 1,2 ,4 ,8 hours selection	Show RUN IN Pass after time out
22	BatRunDwn	RUN DOWN FOR 1 HOUR	
<b>Some items need to test under OS Mode</b>			
24	USB TEST	Link with PC/Notebook to check USB Link function	
25	SIR Test	Infrared port test	Test with second unit
26	RS232 TEST	Link with PC/Notebook to check RS232 Link function	
27	Camera Test	Test Camera Function	
28	Bluetooth	Test Bluetooth function	



## Chapter 6 – Leakage current measurement

This is a quick method to measure if any abnormal leakage current on main board which caused high power consumption compare to GOOD main board.

(1) Requirement :

- Power Supply
- Micro-current Meter
- Current series JIG
- CABLE
- Battery JIG



Equipment need:

- A. Power Supply (set at 4 V /1A).
- B. Micro-Current Meter ( support 0.5mA ~ 1A).

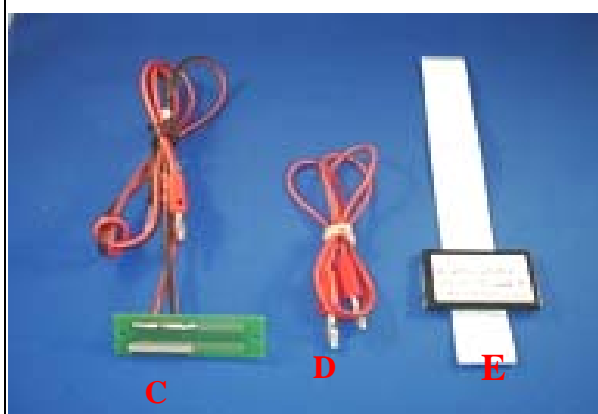

2. Fixture needed

- C. Current series jig.( with black and red cable)
- D. Cable
- E. Battery with extension cable



3. Connect cable (D) to positive polarity of power supply (A) and current meter (B)

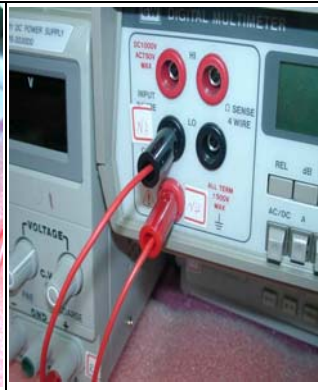
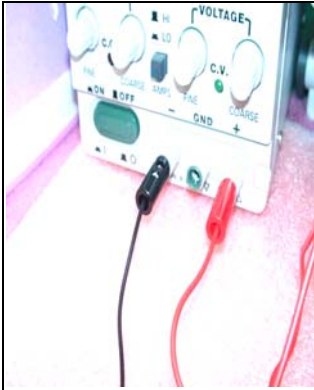

4. Connect cable of fixture( C ) to negative polarity of power supply (A) and current meter (B)

Note : black cable to power supply (A) and red cable to current meter (B)



5. Setting is Ready now for testing  
( Don't turn the power on at this moment )



6. Set the unit to :

- \* Flight mode
- \* Turn on Bluetooth

**Note : Need to put SIM card first on the unit.**



7. Remove original main battery and install battery fixture (E)

8. Turn on power supply ( 4V) and current meter ( 2A)



9. Power on.



10. Measure flight mode current

Wait about 1 minutes, display will be off, in this condition, please check current value on the current meter, Current value must under **5 mA**, if over, it means M/B failed, please replace M/B for repair.



11. Switch OFF the unit.



12. Measure power off current

Check current value on the current meter, Current value must under **0.3 mA**, if over, it means M/B failed, please replace M/B for repair.



**Conclusion:**

If current consumption are passed at both of flight and power off mode, it means M/B is GOOD.

If there is any item FAILED at flight or power off mode, it means M/B is failed, please replace M/B for repair.

**Measurement parameter**

Measurement mode	Measured Current	REMARK
Flight Mode	Under 5mA	MB is good
	Over 5mA	Fail, MB need to be futher repaired
POWER OFF	Under 0.3 mA	MB is good
	Over 0.3 mA	Fail, MB need to be futher repaired

**6.2 Battery Capacity Test (with Rundown program - Diagnostic)**

- (1) Full charge the battery
- (2) Turn power off, then insert Diagnostic SD card (Rev. 1.0T) to handset.
- (3) Set the handset into Bootloader Mode (While Press & Hold Capture button, then press **Power** button).  
Wait for the message "Press Volume down to download SD Image" appears, press ACTION key to into Diagnostic mode.
- (4) Under DIAG menu, GOTO page 3 and select item "4. **BatRunDwn**" to perform Battery rundown test.

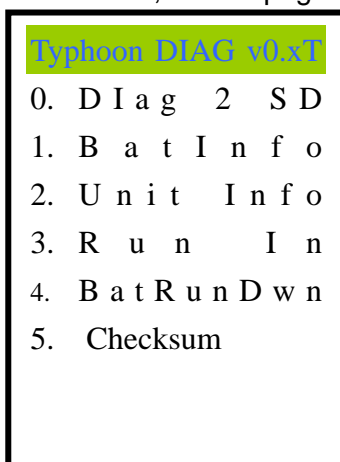





(5) Screen will display as fig. 1

(6) After an hour test, the Battery Rundown Test will stop automatically . Then indicate the test result on the screen (Battery capacity percentage) for your reference(Fig 2)

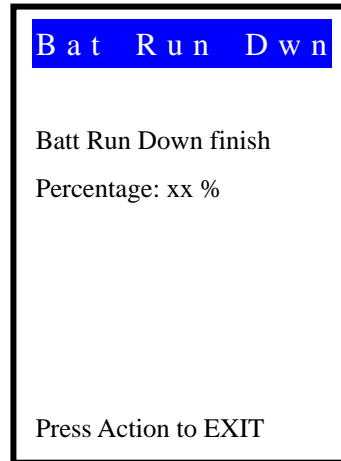
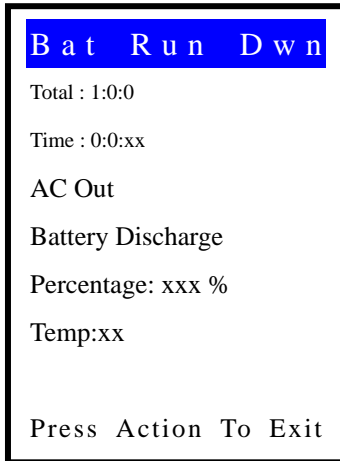

(7) If you would stop the program while testing, press “ACTION” button several times to exit the test program and back to menu screen.

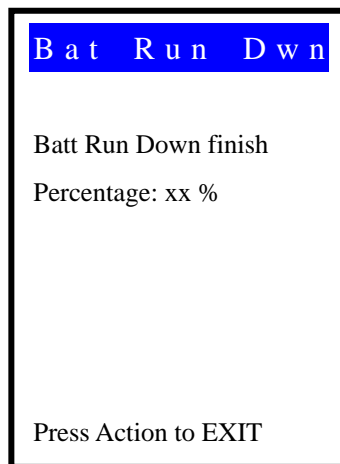

(6) Test Result and Criteria

<b>Run Down 1 hour</b>	<b>Capacity <math>\geq</math> 60 %</b>	<b>GOOD</b>
<b>Run Down 1 hour</b>	<b>Capacity <math>\leq</math> 60 %</b>	<b>Failed</b>

(a) The Battery Rundown Test program is available for the battery in **6-months Warranty period ONLY**.

(b) How to check the warranty period

Check unit serial no or Manufacture Date.



## Chapter 7 – Software Upgrade Procedure

### 7.1 Software upgrades

#### (1) System Requirement :

- Windows 2000 or XP on PC
- USB Cable
- **RUU** tool for Smartphone
- 64MB SD card with latest software version

#### (2) Software upgrade procedure

##### (a) Enable the USB Connection Settings in ActiveSync.

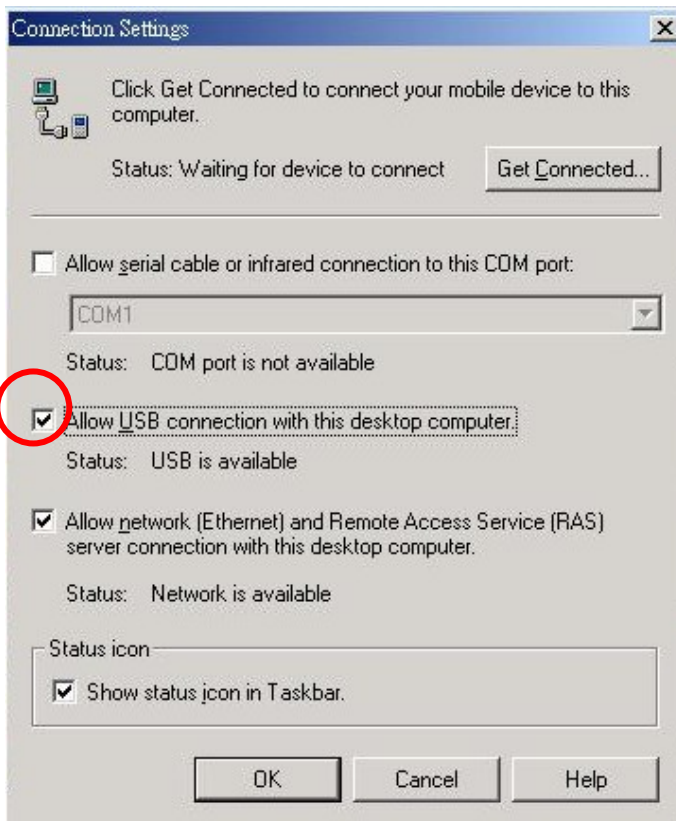

(b) Set the Smartphone into **OS** Mode (SIM card must be inside).

(c) Sync Smartphone to PC via **USB cable** and synchronize with PC.

(d) \*Attach AC Adapter to USB cable (**It's necessary to attach AC Adapter to unit to prevent software upgrade fail**).



(e) Run "RUU" tool under Window 2000. Then Click "Next" to continue.



(f) Select the location to save file then click "Next" to continue.





(g) On your PC, it will show below messages, Check the option on screen:

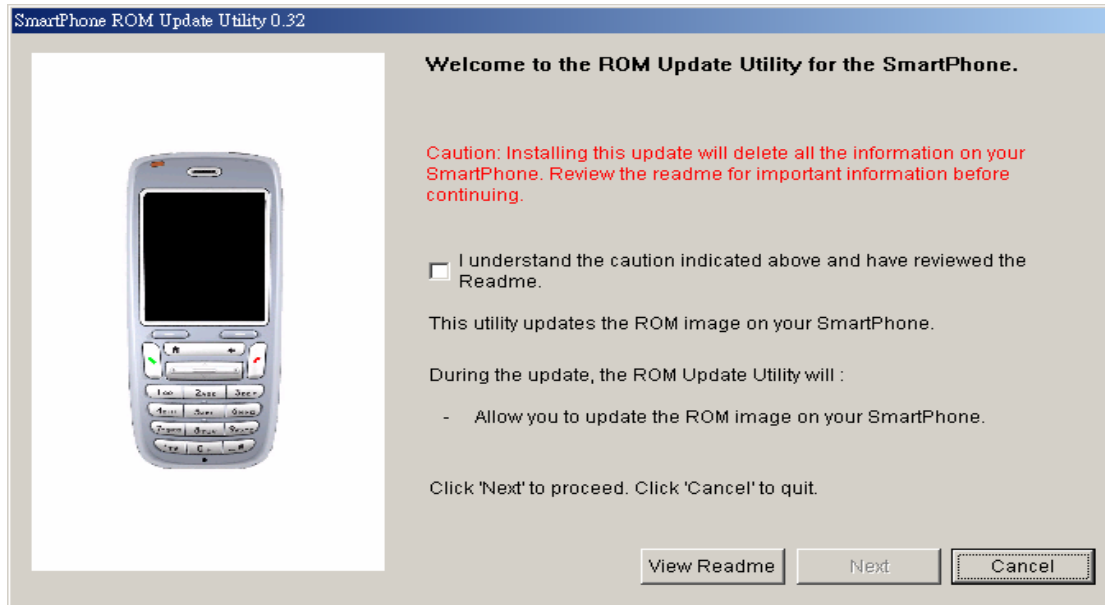

(h) Follow the instruction shown on screen, check the selection part:

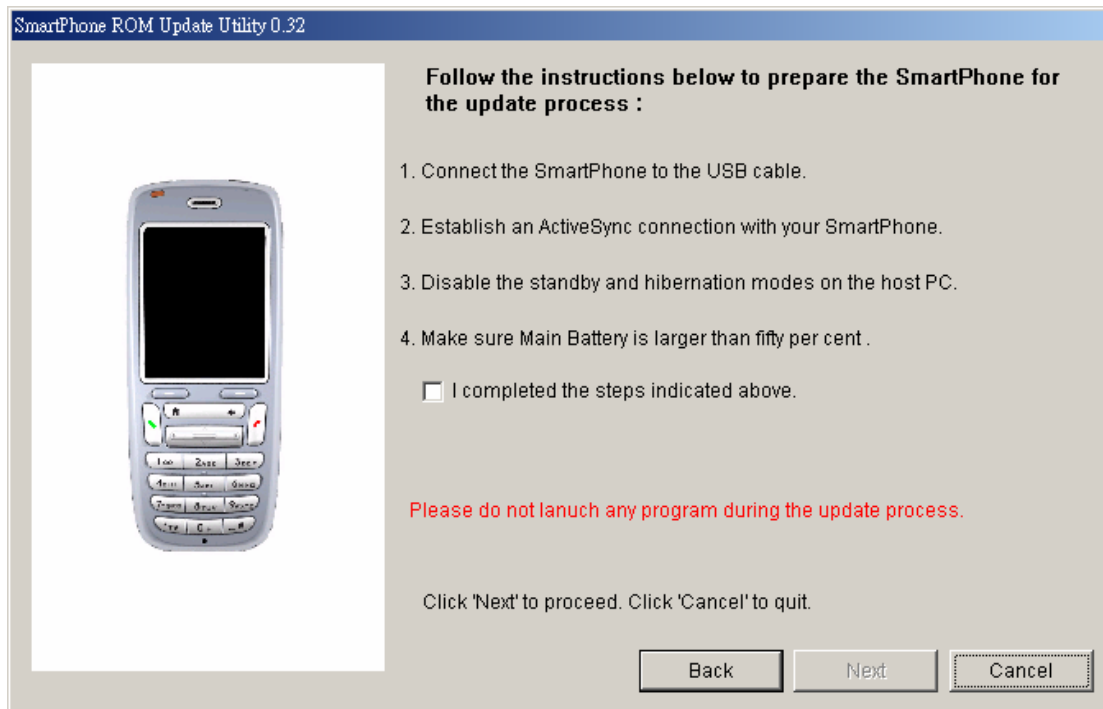



- (i) During the process, PC will show current information about your smart phone, choose update after confirm.

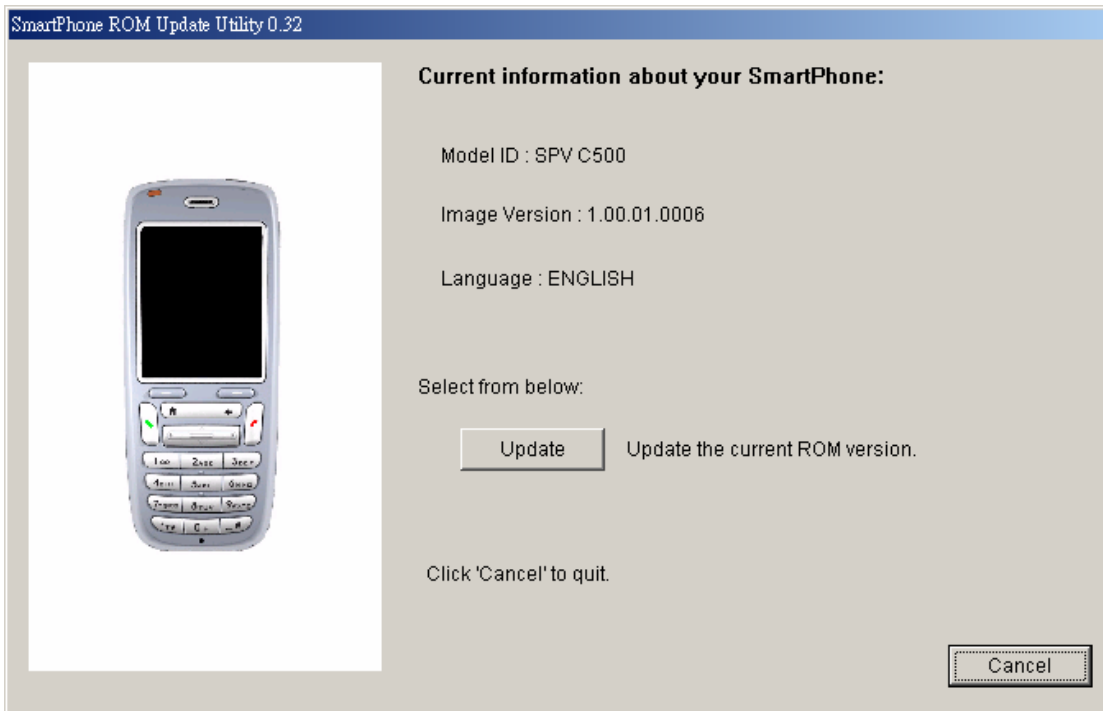

- (k) Choose NEXT if you have verified and want to update

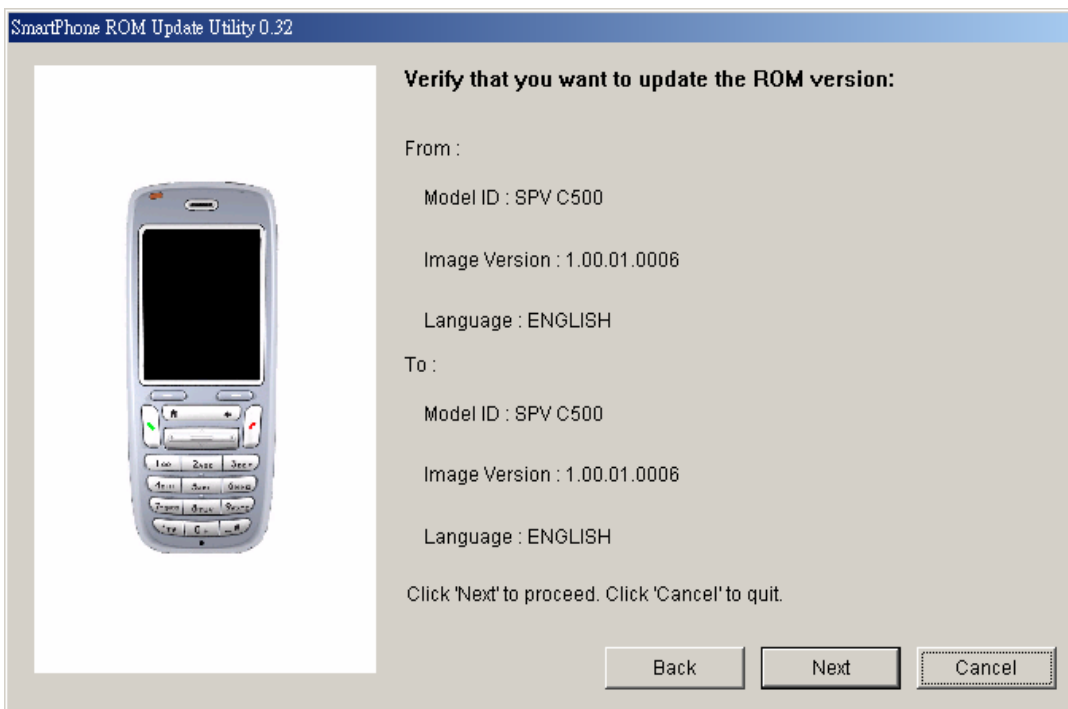



(l) It will take about 10 minutes to complete.

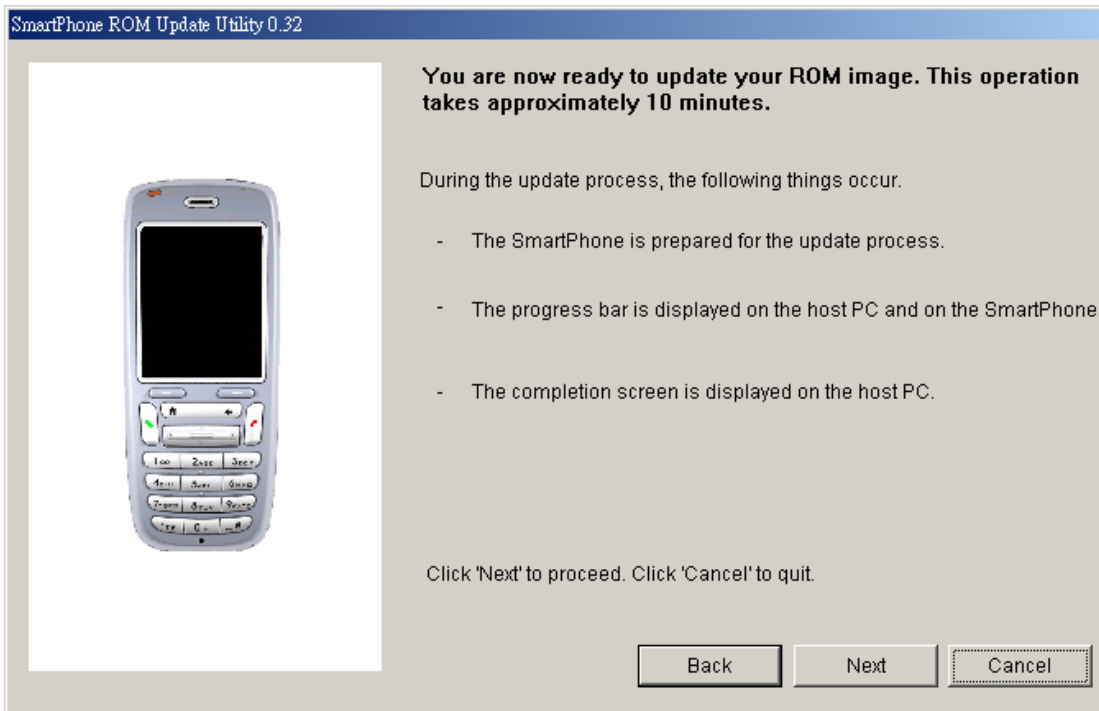

(j) PC will show the RUU progress

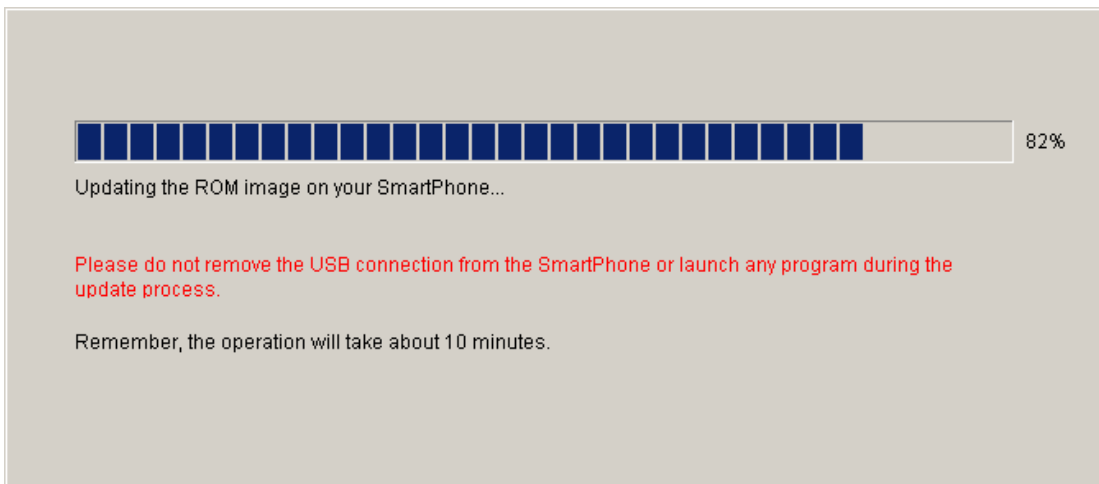

(k) When software upgrade is finished, the Unit will reboot automatically.



(3) Software upgrade from 64MB MINI SD card (with latest software version)

**Caution: The unit must have at least 50% of battery capacity before starting the re-flash process.**

**Charge the battery in advance if necessary.**

- (a) Take one smartphone unit and turn off power.
- (b) Insert 64MB Mini SD card (with latest software version) to unit and set it into SPL Mode(Press and Hold Camera + Power button for 2 seconds).Then release Power button first. The screen shown as below.

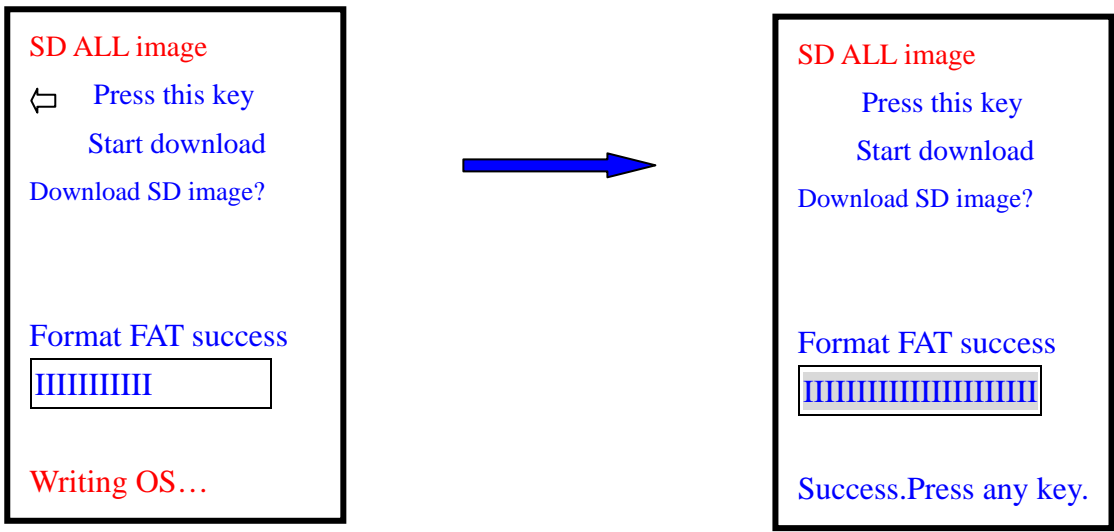

Unit has been re-flash successfully.



## 7.2 Smart phone Reset.

In case if the system is freezing or not working under OS mode, service center could perform “RESET” the smart phone to fix the problem:

- (a) Release the battery and attached again to unit.
- (b) Hold two soft key together , then press power button for 0.5 seconds.

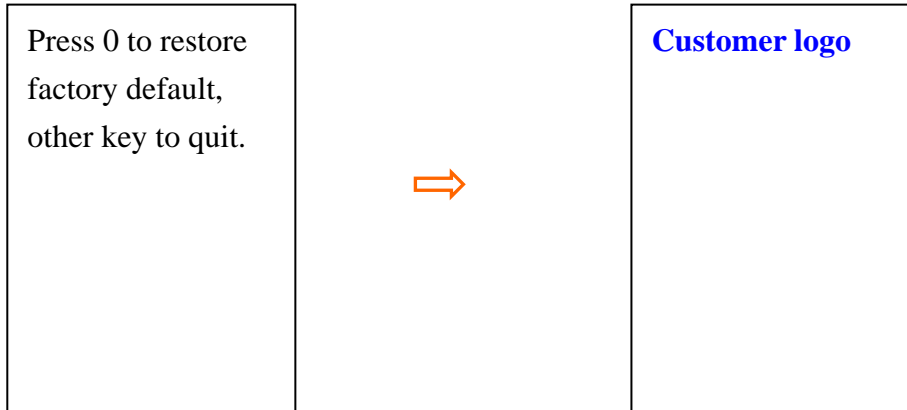

**Warning: This will set phone to original factory setting , there is risk of losing customer data.**

(c ) Unit will reboot .

## 7.3 Smartphone rebuild

- Use only if you feel system is slow performance (weight loading may cause system run slowly).
- Please be noted that there is a **Risk of Losing customer data** and back to factory default setting.

### Procedure:

(1) On Windows mode, Press Start > More >More > Accessories > Clear Storage.

On display it will show:

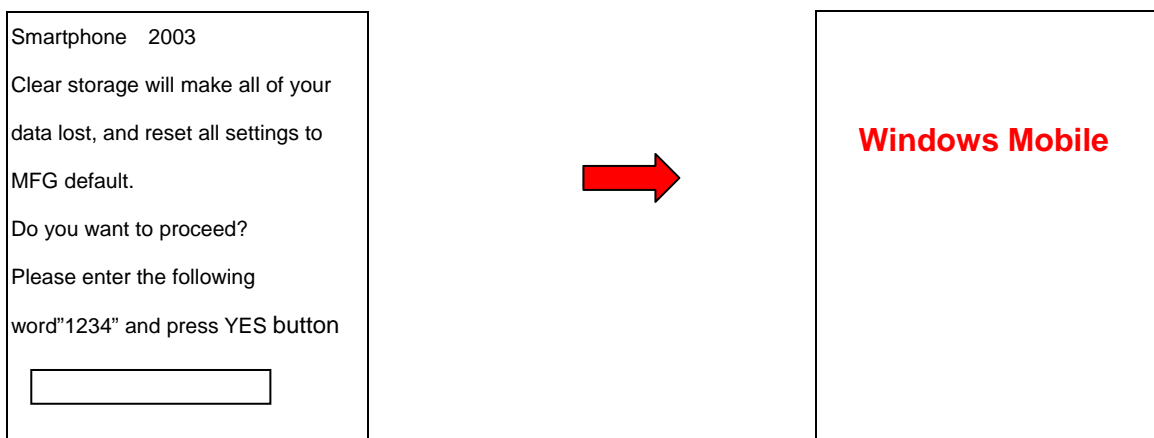





## 7.4 Software back up to SD card

### (A) **Build your own Golden Mini SD card**

1. Flash a golden unit with the last update ROM Code.
2. Insert a 64MB mini-SD card into unit.
3. Enter SPL : Press and hold camera key. Press power key for one or two seconds, release power key.
4. Enter "r2sd all". Check the screen. Wait for the percentage bar reach to the end.
5. After it is completed, turn off the unit. Take of mini-SD card.

### (B) **Flash unit with golden mini-SD "**

1. Insert mini-SD card into unit.
2. Enter SPL : Press and hold camera key. Press power key for one or two seconds, release power key.
3. SPL will ask if you want to flash the unit.
4. IF Yes, Press Volume Down key quickly. Check the screen. Wait for the percentage bar reach to the end.
5. After it is completed, press any key to enter SPL automatically.
6. Power down device by pressing power button or taking out battery.
7. Remove mini-SD card.
8. Insert SIM card.
9. Power on the unit.
10. Boot into OS.

**"Your Mini SD card is ready now for doing Reflash"**

#### **CAUTIONS:**

- Per customer request, due to security reason, UPGRADE/ Reflash to different CID will be blocked, and will not continue.
- Repair for different region or Customer ID should be treated as OOW repair.



## Chapter 8 – RF Antenna test spec and criteria

Item	Test Name	Tx level	TCH	1 <sup>st</sup> Download cell power	Note
1	Camp @DCS Band	0	512	-75	BCH=600
2	BS Originate call	0	512	-75	
<b>GSM 900 RECEIVER TEST</b>					
3	Fast Bit Error Rate	5	975	-104	
4	Fast Bit Error Rate	5	42	-104	
5	Fast Bit Error Rate	5	124	-104	
<b>GSM 900 Transmitter TEST</b>					
6	TX Phase RMS Error	5	975	-104	
7	TX Phase Peak Error	5	975	-104	
8	TX Frequency Error	5	975	-104	
9	TX Phase RMS Error	5	42	-104	
10	TX Phase Peak Error	5	42	-104	
11	TX Frequency Error	5	42	-104	
12	TX Phase RMS Error	5	124	-104	
13	TX Phase Peak Error	5	124	-104	
14	TX Frequency Error	5	124	-104	
15	Check TX Power	5	975	-104	
16	Check TX Power	5	40	-104	
17	Check TX Power	5	124	-104	



<b>DCS 1800 Receiver Test</b>					
1	Fast Bit Error Rate	0	512	-104	
2	Fast Bit Error Rate	0	700	-104	
3	Fast Bit Error Rate	0	885	-104	
<b>DCS 1800 Transmitter Test</b>					
4	TX Phase RMS Error	0	512	-104	
5	TX Phase Peak Error	0	512	-104	
6	TX Frequency Error	0	512	-104	
7	TX Phase RMS Error	0	700	-104	
8	TX Phase Peak Error	0	700	-104	
9	TX Frequency Error	0	700	-104	
10	TX Phase RMS Error	0	885	-104	
11	TX Phase Peak Error	0	885	-104	
12	TX Frequency Error	0	885	-104	
13	Check TX Power	0	512	-104	
14	Check TX Power	0	700	-104	
15	Check TX Power	0	885	-104	



<b>PCS 1900 Receiver Test</b>					
1	Fast Bit Error Rate	0	512	-104	
2	Fast Bit Error Rate	0	660	-104	
3	Fast Bit Error Rate	0	810	-104	
<b>PCS 1900 Transmitter Test</b>					
4	TX Phase RMS Error	0	512	-104	
5	TX Phase Peak Error	0	512	-104	
6	TX Frequency Error	0	512	-104	
7	TX Phase RMS Error	0	660	-104	
8	TX Phase Peak Error	0	660	-104	
9	TX Frequency Error	0	660	-104	
10	TX Phase RMS Error	0	810	-104	
11	TX Phase Peak Error	0	810	-104	
12	TX Frequency Error	0	810	-104	
13	Check TX Power	0	512	-104	
14	Check TX Power	0	660	-104	
15	Check TX Power	0	810	-104	



## Chapter 9 – Inspection Criteria

### 9.1 Definition

The inspection criteria HTC defined is for service center repair ONLY. All service centers must follow below inspection criteria to judge if customer returned unit is exactly “defective” caused by out of HTC’s specification.

### 9.2 Inspection Area

The inspection area of Smartphone is for **LCD module** ONLY.

### 9.3 Criteria

#### Definition:

D: Diameter; L: Length; W: Width ;N: Number of defects ; S: Distance from dot to dot ;H: Height.

Viewing distance for LCM is, approximately: 30cm ±5cm

Ambient illumination is to be 500~1000lux

Inspection viewing angle range: ±30degree Horizontal and ±45 degree Vertical:

#### (1) Defective Dot

Item	Status	Criteria
1	Defective dot > 0.25mm	<b>Fail</b>
2	0.15 < Defective dot ≤ 0.25mm	If the Q'ty of defective dot ≤ 6, <b>Pass</b>
3	Defective dot ≤ 0.15mm	<b>Neglect</b>

Total dot ≤6; Distance between dot and dot >5mm

#### (2) Defective Pixel

Item	Status	Criteria
1	Bright pixel only	If the Q'ty of bright pixel ≤ 3, <b>Pass</b>
2	Dark pixel only	If the Q'ty of dark pixel ≤ 4, <b>Pass</b>
3	<u>Bright + Dark</u> pixels (total)	If total Q'ty of <u>bright + dark</u> pixel ≤ 4, <b>Pass</b>
4	2 bright pixels connected together	If the Q'ty of connected bright pixel ≤ 1, <b>Pass</b>
5	2 dark pixels connected together	If the Q'ty of connected dark pixel ≤ 2, <b>Pass</b>
6	Connected <u>Bright + Dark</u> pixels (total)	If the Q'ty of connected <u>bright + dark</u> pixels ≤ 2, <b>Pass</b>
7	The distance between two bright pixels	If the distance ≤ 6mm, <b>Fail</b>
8	The distance between two dark pixels	If the distance ≤ 6mm, <b>Fail</b>



## Chapter 10 - Trouble Shooting Guide

### (1) Power / Battery

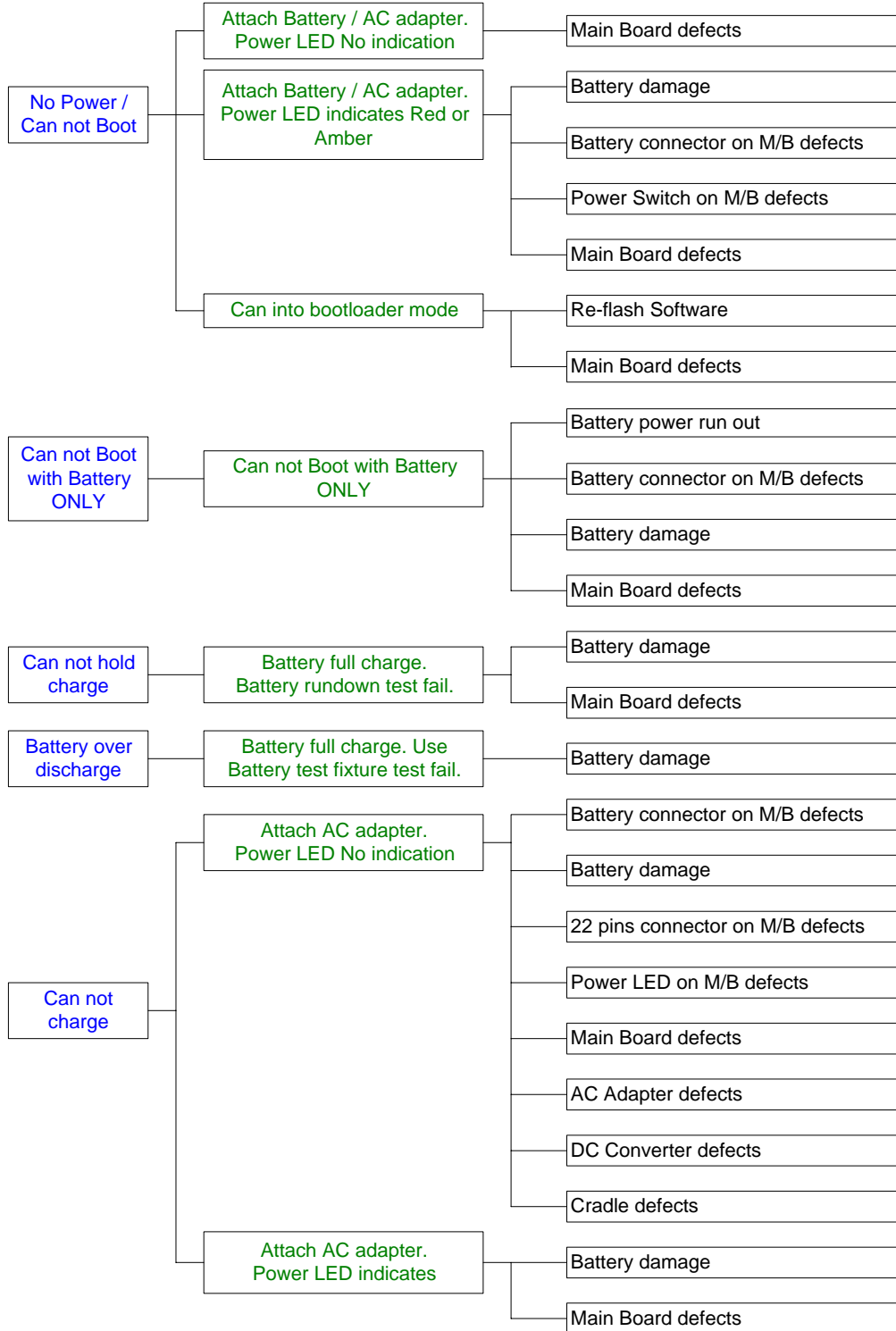

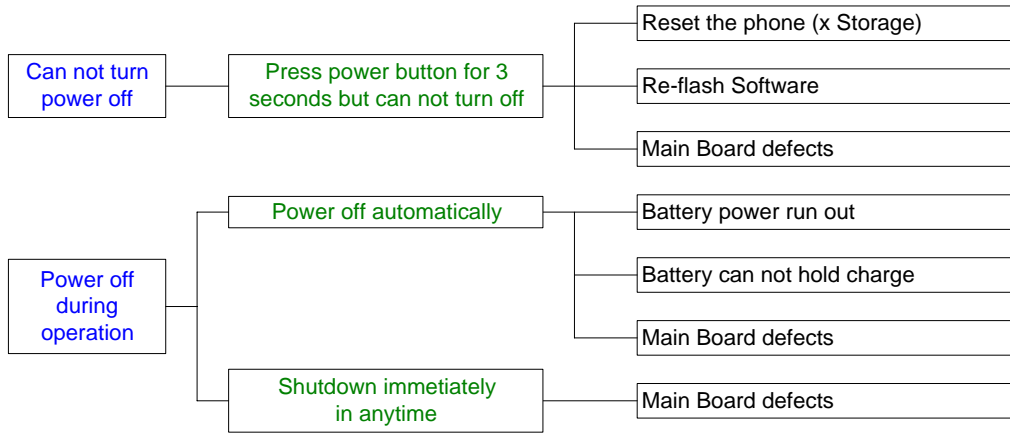

(2) System

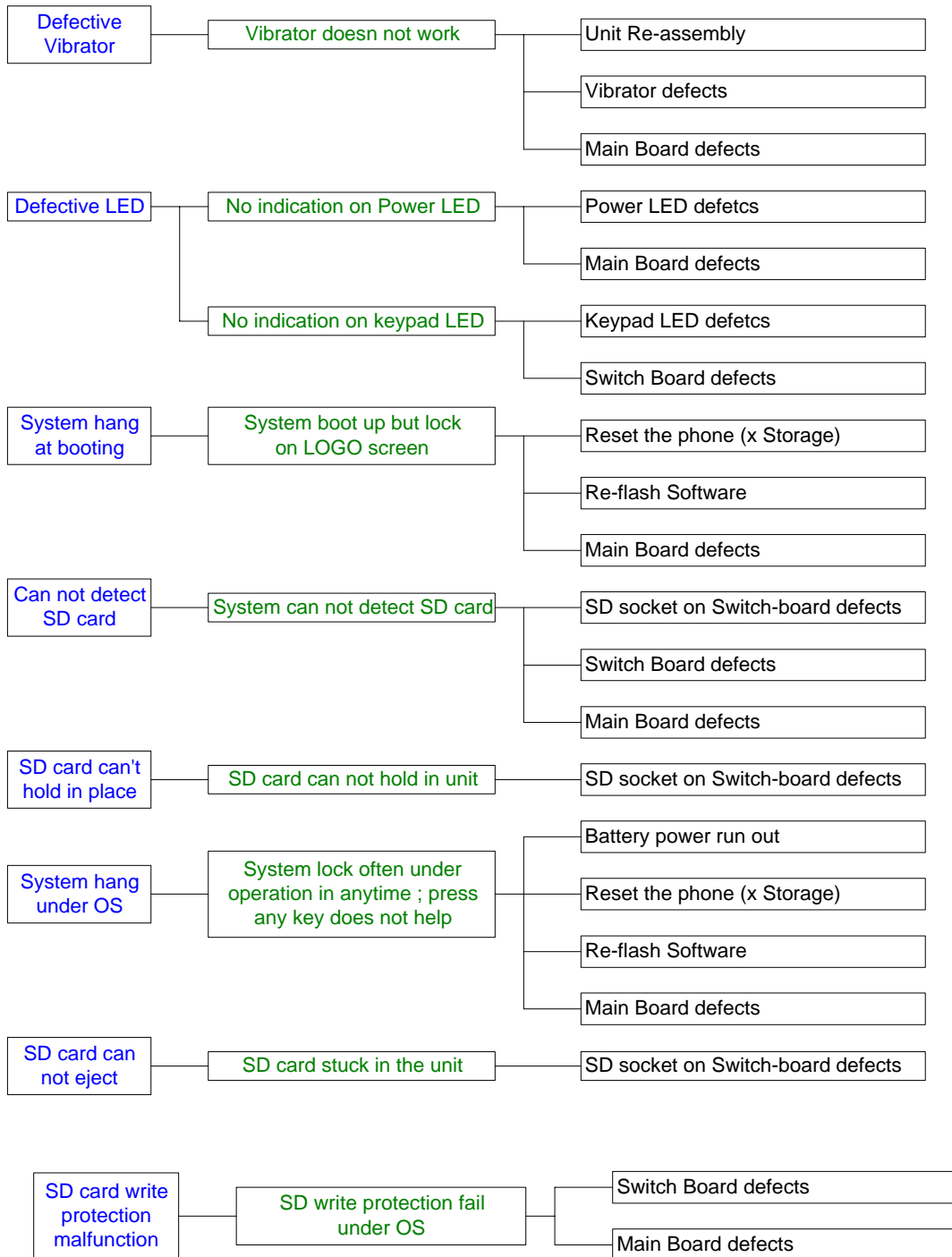





(3) Communication

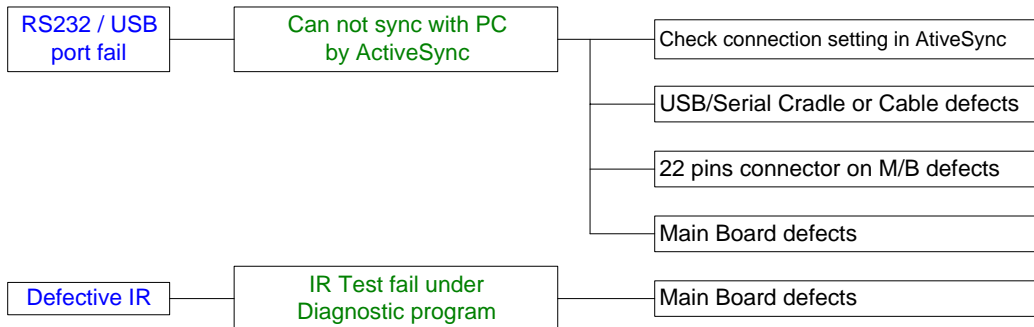

(4) Audio

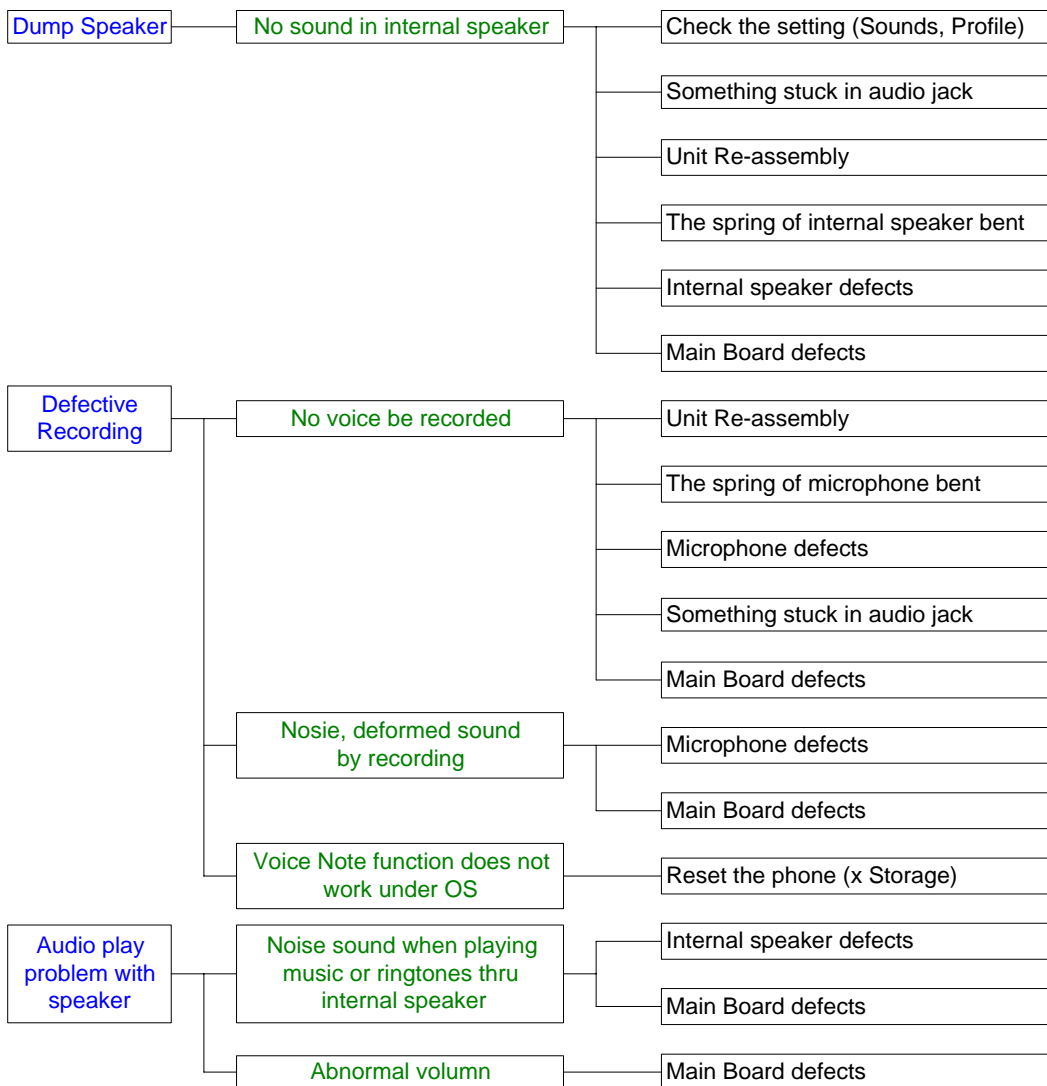

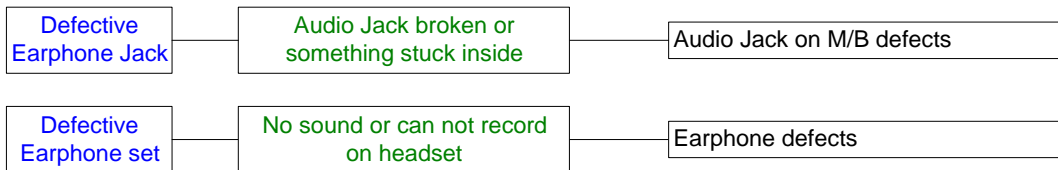

(5) Screen

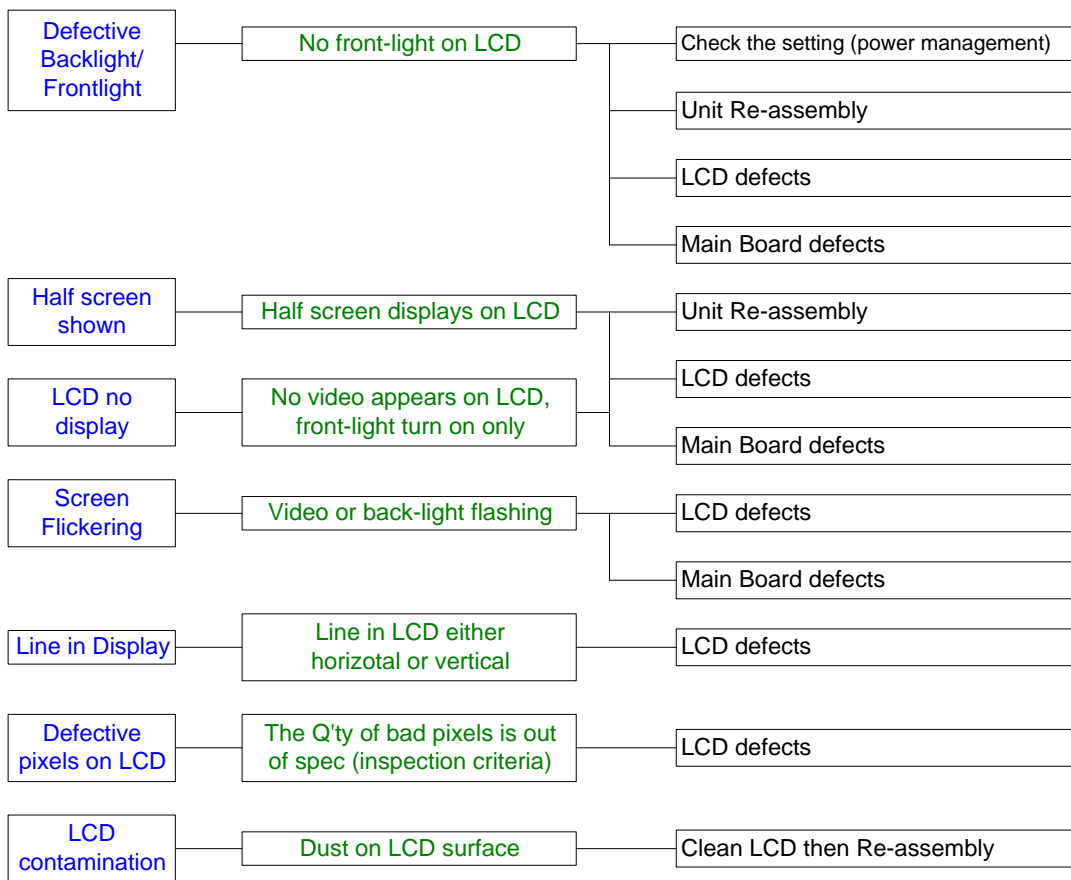



(6) Mechanical

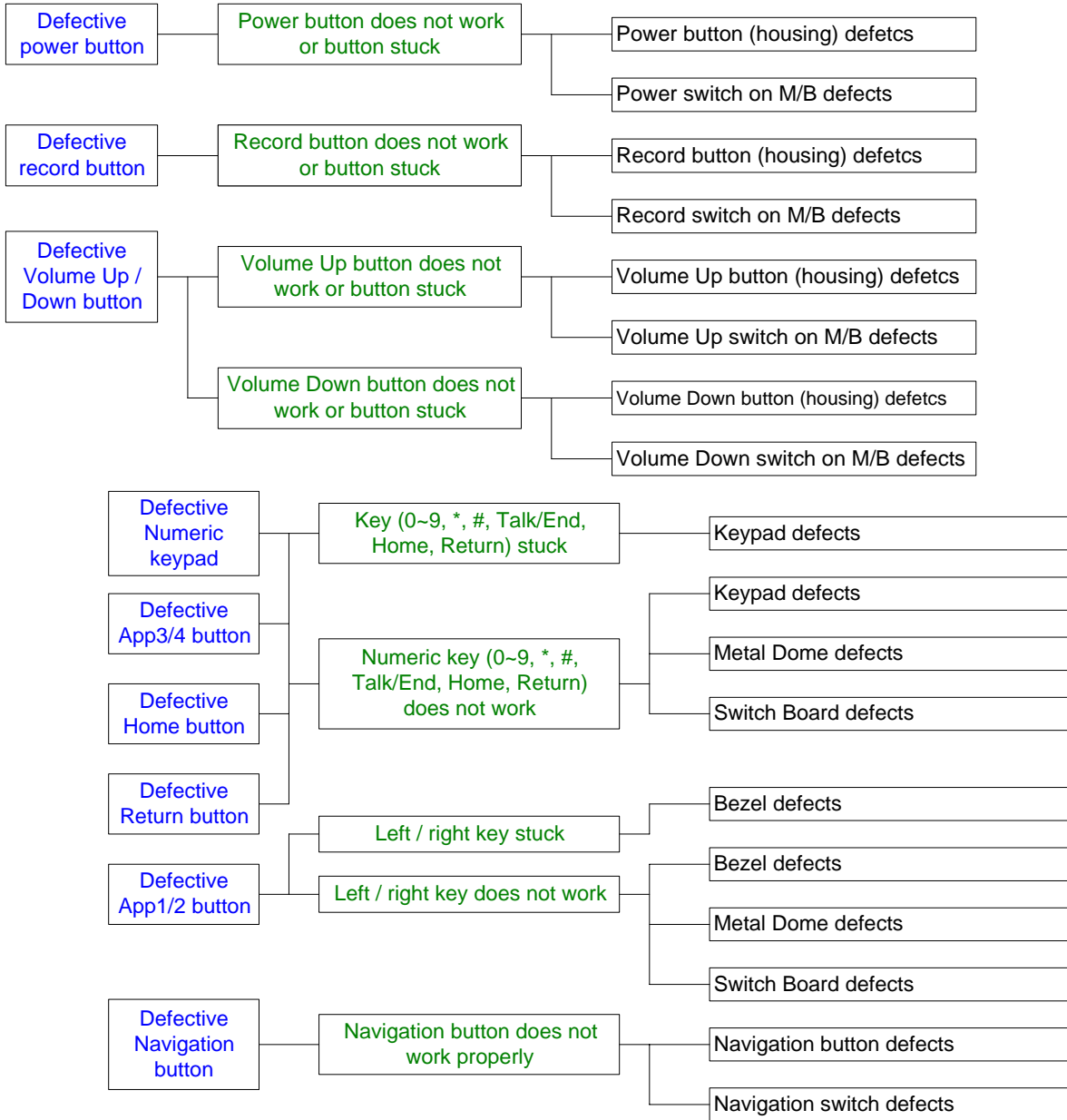

(7) Camera

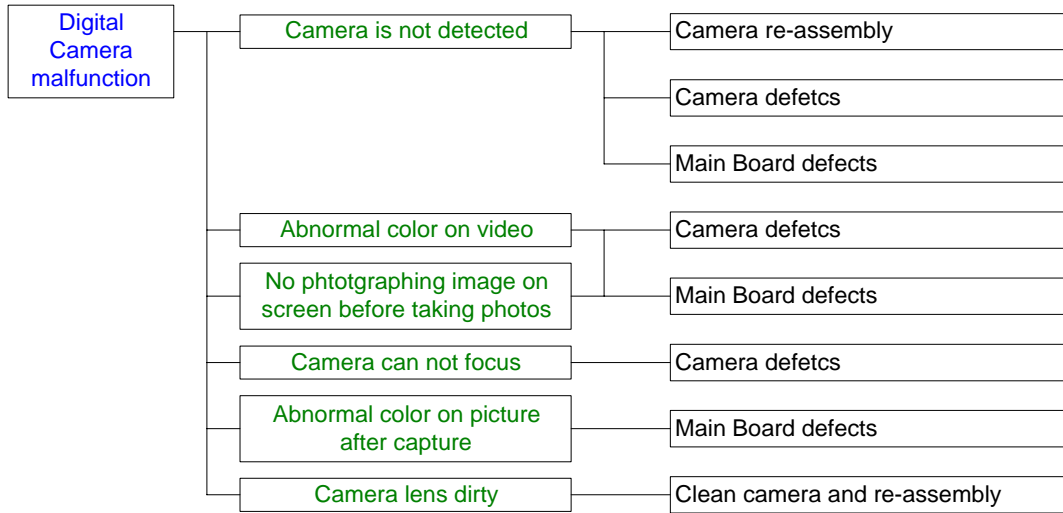

(8) RF / Wireless

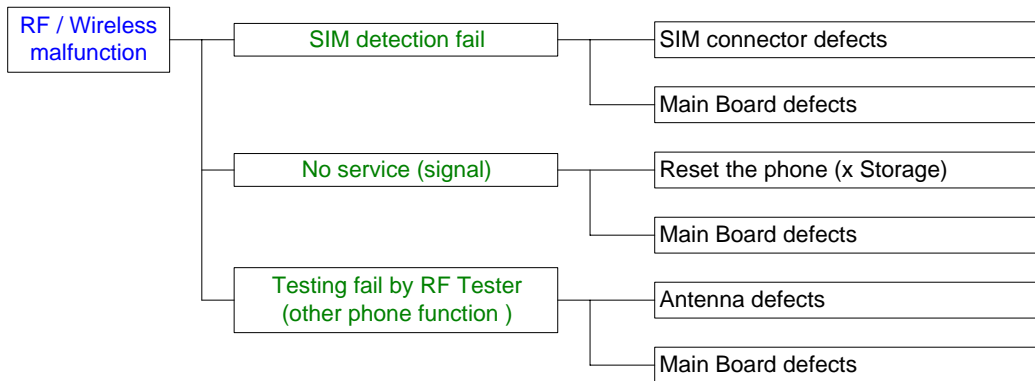



## Chapter 11 – Label Plan

### 1. Main unit

Main unit Regulatory label (on the rear housing of main unit).

1. Brand name is shown on the bezel.
2. All bar codes must be code 128 symbology.

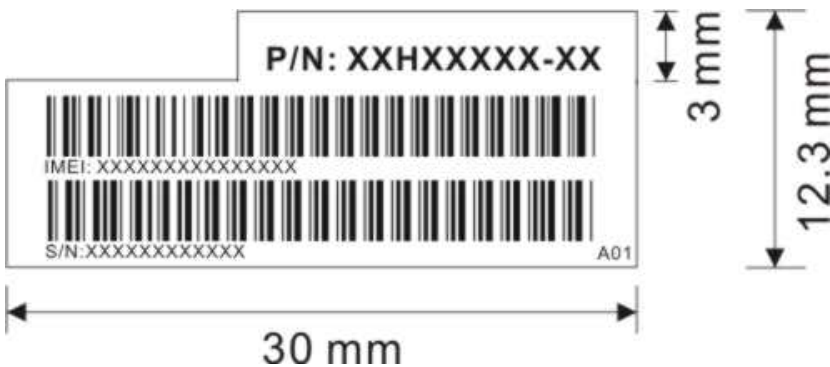

For S/N: SSYWWPPZZZZZ

SS: SITE CODE --> HT

Y: Year Last Digital of the Year.

WW: Week Code (01~54)

PP: Product Code DB->ST20A

ZZZZZ: Serial Number (00001 ~ 99999) Use Base 10

#### Label Characteristic

Material: polyester

Color: White

Ink: B110



**CHP 12 Exploded diagram & Spare Part List**

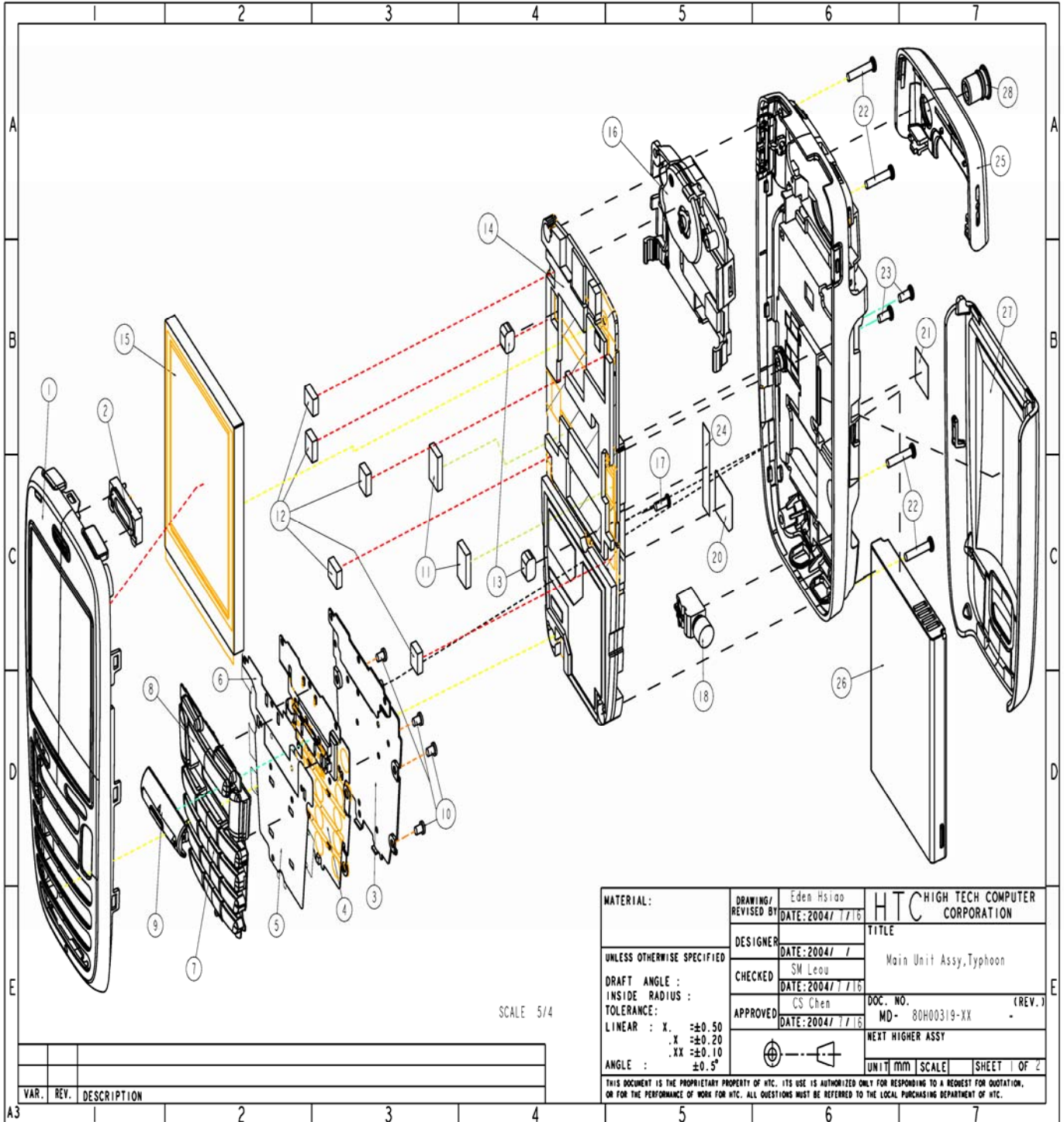









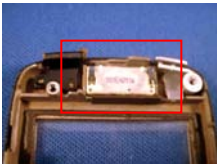







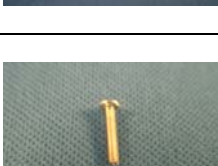
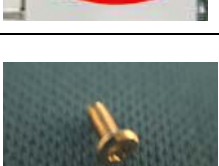

## 12 -2 Spare parts list

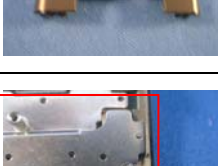
### 12.1 Spare Part List for Repair

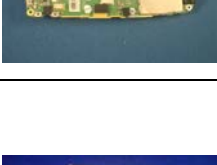
(Please be noticed that Part no on the list below is for reference only, please refer to List from our logistic team which differ per customer )

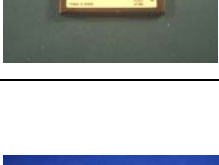
<b>36H00232-00</b>		<b>36H00180-00</b>		<b>71H00854-00</b>	
Antenna Receiver		Vibrator		Function Keypad	
Q'ty : 1		Q'ty : 1		Q'ty : 1	
<b>36H00225-00</b>		<b>73H00118-01</b>		<b>54H00083-00</b>	
Speaker Assy		FPC Assy Keypad		CMOS Camera module	
Q'ty : 1		Q'ty : 1		Q'ty : 1	
<b>60H0002x-xx</b>		<b>74H003xx-XX</b>			
TFT LCD		Front panel		Security label(Warranty seal)	
Q'ty : 1		Q'ty : 1		77H00184-00	
<b>71H00853-00</b>		<b>72H00617-00</b>		<b>72H00616-00</b>	
Numeric Keypad		Screw, M1.6*8.2		Screw, M1.6*3.5	
Q'ty : 1		Q'ty : 4		Q'ty : 2	
<b>74H00312-0X</b>		<b>36H00232-XX</b>		<b>71H00830-XX</b>	
Rear Panel		Antenna radiator(cover)		Battery cover	
Q'ty : 1		Q'ty : 1		Q'ty : 1	
<b>99HAD00X-XX</b>		<b>72H00584-00</b>		<b>35H00044-00</b>	
FRU MB		Metal support		Main Battery	
Q'ty : 1		Q'ty : 1		Q'ty : 1	
<b>76H00595-00</b>		<b>76H00596-00</b>		<b>76H00597-00</b>	
Gasket		Poron, LCD ground, L32, Typhoon		Poron, LCD support, H48, Typhoon	
Q'ty : 1		Q'ty : 1		Q'ty :	



Rubber boot MIC		Camera lens		Gasket fabric	
76H00598-00		71H00824-00		72H00718-00	
Q'ty : 1		Q'ty : 1		Q'ty : 1	
Mirror		Mylar mini SD		Liquid damage indicator	
74H00319-00		76H00561-00		77H00193-00	

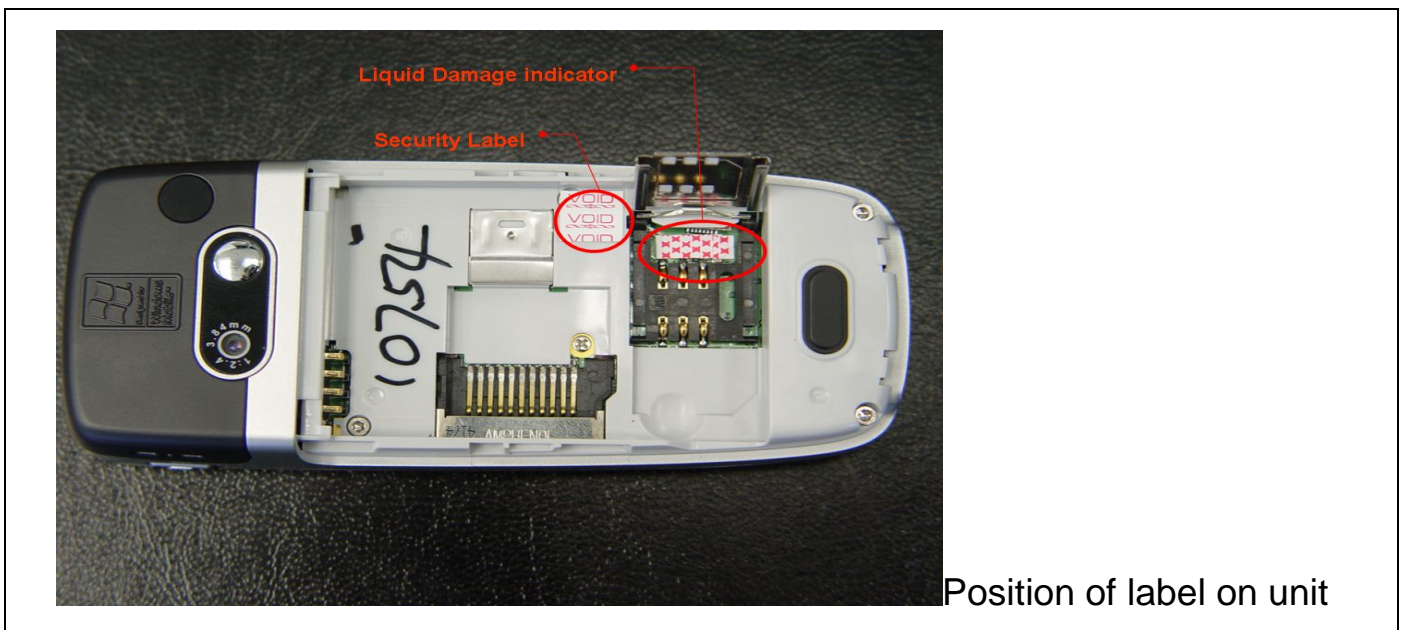





---

## Chapter 13- Board Level Repair

If you are authorized by HTC to perform board level repair , you could ask below material/parts from HTC .

### 13.1 Problem Identification & Troubleshooting

(1) Basic Repair Instructions for Component Replacement :

**Step 1.** Place the solder-proof tape to cover the surrounding area of the components which being replaced.

**Warning :** *DO NOT overheat the tape and components to avoid the tape melted and make the component damage.*

**Step 2.** Use Heater Gun (HAKO850B, set the temperature between 350°C , Air Speed 3~5) to remove the components.

**Step 3.** It has to wait the temperature cool down before the damaged components been removed. Or, the others components could be gone when the solder-proof tape been taken off.

**Step 4.** After the damaged component has been replaced, clear the surroundings for solder and flux residues.



### 13.2 Main Board :

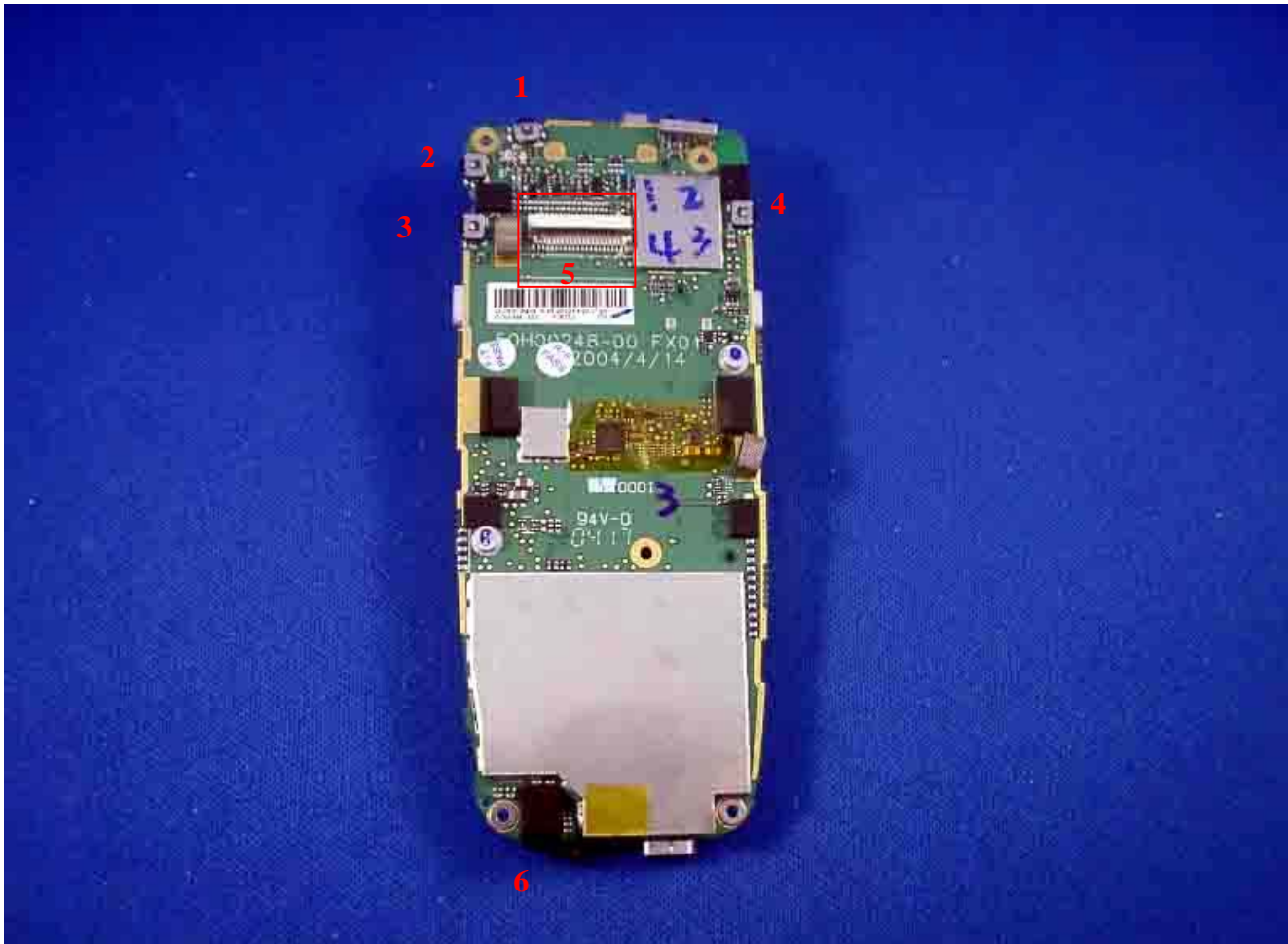

**Parts that could be replaced from MB front side**

NO	Part location name	HTC Part No	REMARK
1	Power switch button	36H00230-00M	SW1
2	Volume up	36H00230-00M	SW2
3	Volume down	36H00230-00M	SW3
4	Camera capture	36H00230-00M	SW4
5	Connector FPC,39P (LCD )	75H00371-00	Con 3
6	MIC	36H00208-00M	MIC1

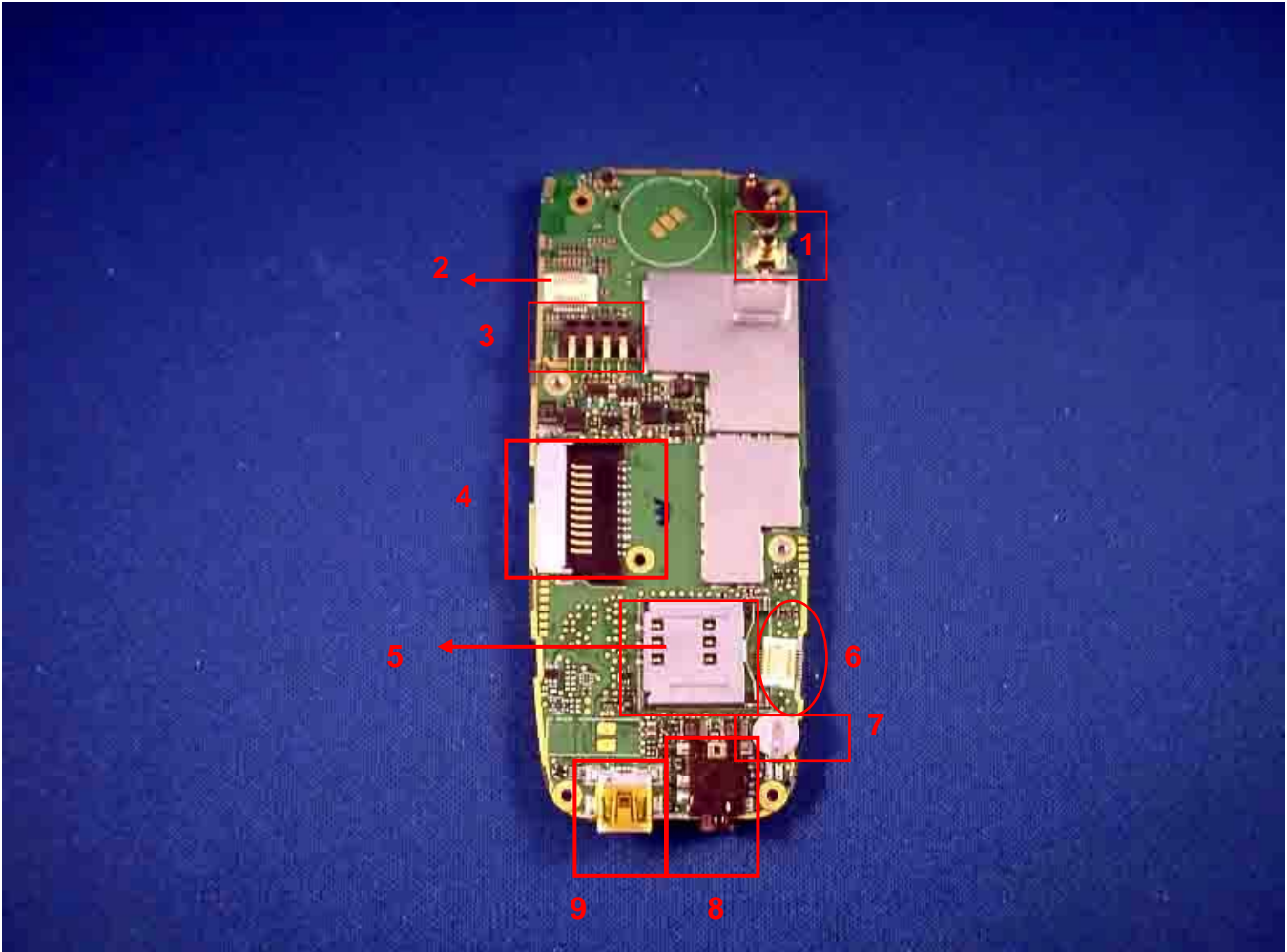

**Parts that could be replaced from MB Back side**

NO	Part location name	HTC Part No	REMARK
1	RF Antenna connector	75H00160-00	WSW1
2	Camera connector (20P)	75H00337-00	CON4
3	Battery connector	75H00332-00M	CON10
4	Mini SD Connector	75H00352-00	CON6
5	SIM Connector (6p)	75H00378-00	CON 9



---

6	Connector B to B(Keypad Connector,16P)	75H00351-00	CON5
7	Back up capacitor	16H00005-00	CG1
8	Audio Jack	36H00059-00	ACON1
9	I/O Mini USB connector	75H00379-00	CON7

**~End of Service Manual~**