



Service Manual

PDA Phone Product

PRODIGY



HTC Proprietary
Confidential Treatment Requested

Rev. A
Nov 16, 2005

HTC Corp.
Engineering Mobility



TITLE: Service Manual for PRODIGY

REV. NO.	DATE	CONTENTS	DEP.	REVISED	APP'D	STGE.PER.
XA	Aug 13, 2005	First release	GSD Technical Support	Johnson Yang	Henry_Lai	
A	Nov 16, 2005	Formal release for MP stage	GSD Technical Support	Johnson Yang	Henry_Lai	



Table of contents

1. INTRODUCTION	5
2. PRODUCT SPECIFICATIONS	5
2.1 PRODUCT CONFIGURATION	5
2.2 SPECIFICATIONS OF PRODIGY	6
3. LABELING	10
3.1 MAIN UNIT REGULATORY LABEL	10
3.2 SERIAL NUMBER DESCRIPTION	10
4. SERVICING TOOLS	11
5. ASSEMBLING AND DISASSEMBLING	12
5.1 DISASSEMBLING	12
5.2 ASSEMBLING	26
5.3 NOTIFICATION ONCE PERFORMING GOLDEN CAP REPLACEMENT	37
5.4 NOTIFICATION ONCE PERFORMING M/B REPLACEMENT	38
5.5 NOTIFICATION ONCE PERFORMING LCM REPLACEMENT	39
5.6 NOTIFICATION ONCE PERFORMING RIGID-FLEX BD REPLACEMENT	40
5.7 NOTIFICATION ONCE PERFORMING LCM HOUSING OR KEYPAD BEZEL REPLACEMENT	41
6. EQUIPMENT OF PROBLEM DIAGNOSTICS	43
6.1 LIST OF TEST JIGS	43
6.2 H/W REQUIREMENT FOR PC	43
6.3 SOFTWARE REQUIREMENT	43
7. DIAGNOSTIC PROGRAMS	44
7.1 LIST OF TEST ITEMS	44
7.2 TEST ITEMS OPERATION	45
7.3 HOW TO EXECUTE DIAG TEST PROGRAM	45
8. BATTERY TEST/JUDGEMENT PROCEDURE	46
8.1 CERTIFICATION FLOW	46
8.2 CURRENT CONSUMPTION MEASUREMENT	47
8.3 WHOLE UNIT CHARGE AND DISCHARGE TEST	50
8.4 BATTERY PERFORMANCE ON UNIT WITH RUN DOWN PROGRAM	51
9. LCM INSPECTION CRITERIA	55
10. RF TEST	57
10.1 GSM FUNCTION TEST	57
10.2 H/W REQUIREMENT	57



10.3 TEST CONNECTION.....	57
10.4 RF ANTENNA TEST SPEC.	58
10.5 BLUETOOTH FUNCTION TEST	62
10.6 WLAN FUNCTION TEST	66
11. FIRMWARE OF OS/ RADIO UPGRADE	68
11.1 RUU	68
11.2 UPLOAD FIRMWARE CODE FROM MASTER UNIT TO MINI-SD CARD	74
11.3 USE PRE-LOADED MINI-SD CARD TO RE-FLASH UNIT	79
12. TROUBLE SHOOTING AND REPAIR	80
13. SPARE PART LIST	85
13.1 UNIT SPARE PART LIST.....	85
13.2 BOARD LEVEL SPARE PART LIST	87
14. APPENDIX.....	88
A. CUSTOMER, RETAILER MISJUDGMENT.....	88
B. HOW TO PERFORM WARM -RESET AND HARD-RESET	90
C. REMOVE MAIN BATTERY BEFORE TURN OFF UNIT.....	90
D. RE-FLASH AGAIN ONCE FAILED DURING RE-FLASH PROCESS	90
E. IF UNIT HANG ON 100% WHILE USING RUU RE-FLASH	91
F. IF THE SCREEN IS FROZEN AFTER RE-FLASH	91
G. IF UNIT CAN NOT TURN ON	91
H. COMPONENT COMPATIBLE REQUEST	91
I. DIAGNOSTIC CARD VS. UNIT'S SPL VERSION	92



1. Introduction

This manual provides the technical information to support service activities of PDA phone (Prodigy). This document contains highly confidential information, any or all of this document should not be revealed to any third party.

2. Product Specifications

2.1 Product Configuration

Standard Package

ITEM	CONTAINS
1	Main Unit
2	Stylus
3	AC Adapter w/ mini –USB plug
4	Stereo wired headset with microphone
5	Carrying Case
6	Car Kit
7	User's Manual, Quick start guide, Sync., S/W (CD)
8	Battery
9	Travel charger
10	User's Manual



2.2 Specifications of Prodigy

Item	Specification
Soldering status	<ul style="list-style-type: none"> ● Meet Lead-free requirement
Platform	<ul style="list-style-type: none"> ● Microsoft Windows Pocket PC phone edition ● PDA form factor integrated quad-band GSM/EDGE, Bluetooth, WiFi, 1.3/2 mega-pixel camera, and sliding QWERTY keyboard
Outside Dimensions	<ul style="list-style-type: none"> ● 58mm(W) x 109mm(H) x 23.7mm (T)
Weight	<ul style="list-style-type: none"> ● Less than 160 g (Main unit with battery pack)
Battery	<ul style="list-style-type: none"> ● Removable rechargeable Lithium Polymer battery ● 1250 mAH ● Battery Life: <ul style="list-style-type: none"> * WMA: 12 hours * WMV: 8 hours ● Talk time: 3.5 ~ 5 hrs ● Standby Time: 150 ~ 200 hrs
AC Adapter	<ul style="list-style-type: none"> ● AC input 100 ~ 240 Vac, 50/60 HZ ● DC output : 5V / 1A (typical)
GPRS/GSM (Tri-band) module	<ul style="list-style-type: none"> ● Quad-Band (850/900/1800/1900)MHz ● Internal Antenna ● Audio codec: AMR, EFR, FR, HR ● Supplement services <ul style="list-style-type: none"> * Call holding/waiting/ forwarding * CLI (Call line Identity) * Display own number * Network selection * Cell broadcast * Multi-party conference call * Spool Icon * Network lock



EDGE functionality	<ul style="list-style-type: none"> ● EGPRS Class B, ● Multi-slot Class 10 ● PBCCH ● Incremental Redundancy
SIM	<ul style="list-style-type: none"> ● 1.8V/3V SIM Operation ● SIM Application Tool Kit release 98 class 3 ● Over the Air (OTA) programming ● FDN/AND/SDN ● Security PIN 1&2 control
Memory	<ul style="list-style-type: none"> ● ROM: 128MB (for program and users' storage) ● RAM: 64 MB DDR SDRAM
Processor/Chipset	<ul style="list-style-type: none"> ● TI OMAP 850
LCD Module	<ul style="list-style-type: none"> ● 64K-color TFT Transflective LCD with white LED back light ● 2.8" 240 x 320 dots resolution ● Sensitive Touch Screen
Interface	<ul style="list-style-type: none"> ● One Infrared port IrDA SIR ● 1.8V/3V SIM card ● Mini-SD card slot (top) ● 2.5 ϕ stereo audio jack ● External antenna connector
Stylus	<ul style="list-style-type: none"> ● Lock type mechanism
Keyboard/Button/Switch	<ul style="list-style-type: none"> ● Five way navigation button ● Power button ● Volume control button (up & down) ● 2 phone button, Send (Yes) & End (No) ● 2 AP buttons (message-left, IE-right) ● 2 soft keys ● Camera shutter button ● Voice command/Voice recorder button ● Reset Switch ● RF button ● Sliding QWERTY keyboard with 39 keys + 2 soft keys



Notification	<ul style="list-style-type: none"> ● One Bi-color LED for GSM standby, GSM message, GSM network status, notification, and charging status. ● Two respective (blue and green) LEDs for for Bluetooth/ WiFi notification. ● Notification by sound, Message, Vibration on the display.
CMOS Camera	<p>Main Camera (manufacture option)</p> <ul style="list-style-type: none"> ● CMOS 1.3 mega Pixel with fixed lens ● Or CMOS 2.1 mega Pixel with macro lens ● Video/flash light ● Preview Mirror
Audio	<ul style="list-style-type: none"> ● Build-in Microphone ● Receiver ● Dual speaker on both sides ● Loud speaker for Hands-free supported ● Full duplex ● WAV/WMA/AMR/AAC/MP3 codec. ● 16 bits with 8KHz,11 KHz, 22KHz,44.1 KHz, sampling rate
Bluetooth	<ul style="list-style-type: none"> ● Compliant with V1.2 ● Class 2 transmit power ● Supported profiles: <ul style="list-style-type: none"> ➤ Generic Access profile ➤ Serial Port profile ➤ Headset profile ➤ Object Push profile ➤ DUN profile ➤ Heads-free profile ➤ Generic Object Exchange profile ➤ HID profile ● Co-exist with WiFi



WiFi	<ul style="list-style-type: none"> ● IEEE 802.11b/g compliant ● Internal WLAN Antenna ● 11, 5.5, 2 and 1 Mbps per channel, auto fallback for extended range ● ELP mode ● Support 802.11i&AES ● Security <ul style="list-style-type: none"> * WPA authentication ● QoS <ul style="list-style-type: none"> * 802.11 WME QoS * 802.11e is preferred *Fast AP to AP handover
Regulatory	<ul style="list-style-type: none"> ● PTCRB ● R&TTE: EMC/EMI, CEM, Safety ● FCC ● WiFi Certification ● Bluetooth Certification ● Microsoft Windows Mobile version 5.0 logo
Accessories	<ul style="list-style-type: none"> ● Carrying Case ● AC adapter with mini-USB plug ● Sync. Cable (mini-USB) ● Battery (rechargeable and replaceable) ● Car adapter ● Stylus ● Car Kit w/car stereo mute function ● Stereo-wired headset with microphone ● Mono bluetooth headset with microphone ● Keyboard ● Cradle (optional) ● User manual, quick start guide, Sync. S/W (CD) ● Travel charger



3. Labeling

3.1 Main unit Regulatory label (Stick on the keypad housing of main unit)

Here is an example only. Actually printing format is depended on customer's request. Repair center need to re-print new regulatory label once replacing M/B for new IMEI, As to printing format, please refer to returned unit from end user.



Label Characteristic:

Material: polyester

Color: pantone 422c

Ink: pantone 425c

3.2 Serial number description

For S/N: SSYWWPPZZZZZ

SS: SITE CODE --> HT or TW

Y: Year Last Digital of the Year.

WW: Week Code : **01 ~ 54**

PP: Product Code : **By HTC define**

ZZZZZ: Serial Number (00001 ~ 99999) Use Base 10



4. Servicing Tools

This chapter provides information for the servicing tools for Prodigy.

Repair Level Definition

Unit

- L0 Accessory test and unit swap
- L1 Unit Test and ROM Re-flash
- L2 Refurbishment and Module Swap +L1
- L2.5 M/B Repair(connector, button, MIC...) +L2

List of Servicing Tools

level	No.	Item	Use for	Remark
L 1	1	Mini USB DATA interface Cable	Check for mini USB communication; RUU re-flash	
	2	Earphone Headset	For Audio test.	
	3	AC Adapter	Transfer AC to DC for Unit	
	4	WLAN AP	For WiFi test	
	5	Mini Memory Card with Diag. test program (need be encoded by HTC)	For unit Diag. test	HTC design
	6	128MB mini SD memory card (must be encoded by HTC)	For unit Re-flash ROM code transfer to mini SD card	HTC design
	7	Unit current consumption test fixture	Measure Unit current consumption	HTC design
	8	Power supply		
	9	Current Meter		
		10	Mobile tester	For RF test
L 2	11	Special Made Plastic Stick	Assembly & Disassembling	HTC special tools
	12	Hand tools	Assembly & Disassembling	
	13	Label printer	Print agency label if replacing M/B	
L 2.5	14	Lead-free Soldering station	Board level repair	
	15	Air heater	Board level repair	



5. Disassembling and Assembling

5.1 Disassembling



Tools needed of Assembling and Disassembling **Prodigy**

From left to right in the picture

1. Lens Cleaning Tissue.
2. Philip Screw Driver #0.
3. Torex Screw Driver T5X40
4. Special Made Plastic Stick.
5. Tweezers.



Remove the Stylus, mini-SD Card slot Filler, and protection rubber of antenna connector.



Next, Remove the battery cover by releasing lock switch



Remove battery cover

 **Warning:** To reduce risk of fire or burns, do not disassemble, crush, puncture, short external contacts, or dispose of in fire or water. Replace only with specified batteries. Recycle or dispose of used batteries properly



Remove main battery from unit



Use the plastic stick to Insert and gently twist into the gap between keypad housing and antenna cover.



Unlock the inside hook



There are 2 hook on the top side of Antenna cover,
Use 2 thumbs to push the bottom of antenna cover

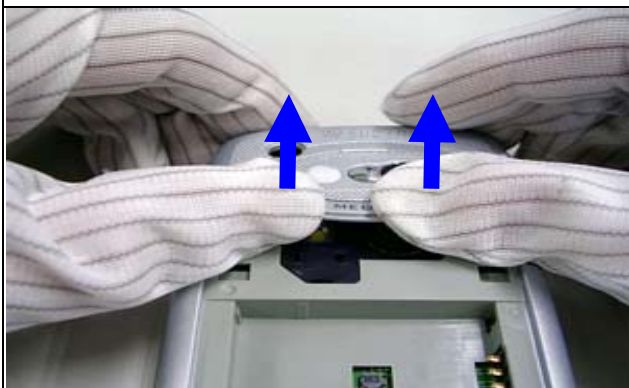

Take care of disassembling Antenna cover during the process, it is easy to damage the hook of Antenna cover



Antenna cover is removed

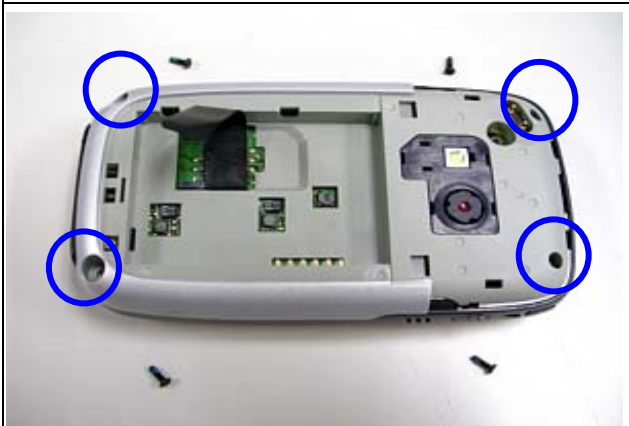

Release 4 screws from keypad housing



To insert plastic stick into the gap of top of keypad housing



Unlock hook



There are 3 hooks at right side



Another 3 hooks at left side



Disassembly keypad housing



The keypad housing is removed

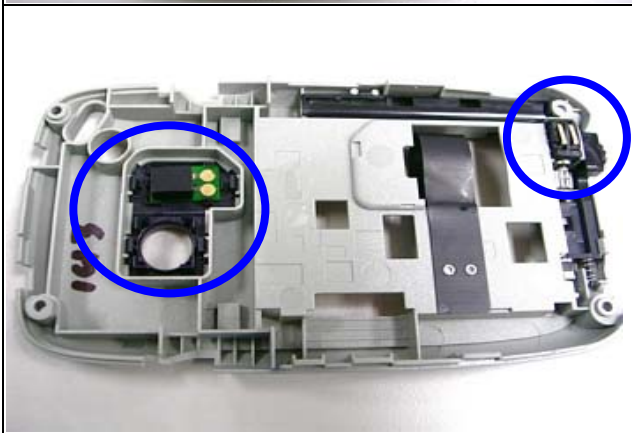

There are 2 parts on the keypad housing,
1. Flash light
2. Vibrator



Use Plastic stick to unlock hooks of flash light module



Use tweezes to remove Vibrator

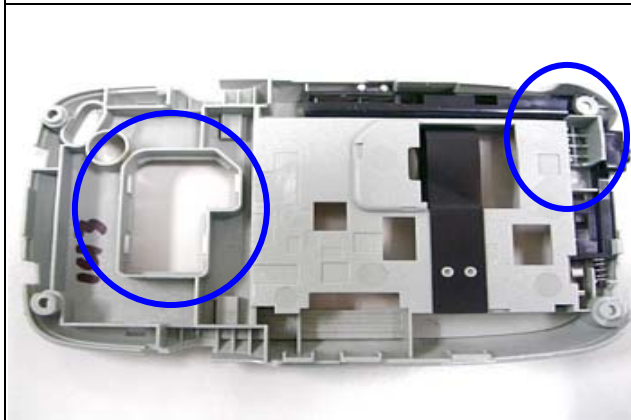

Flash-light module and Vibrator are removed

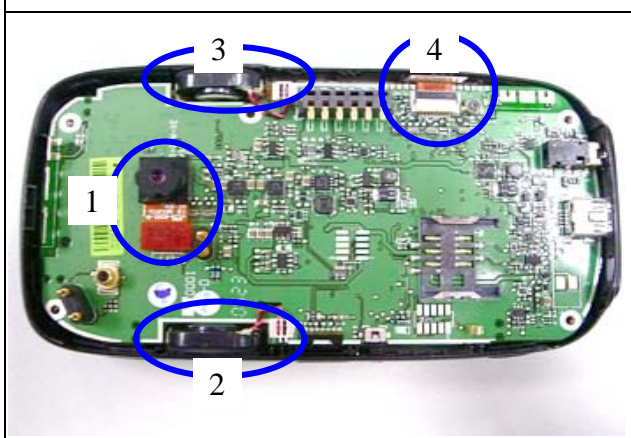

Following need to be removed

1. Camera
2. Speaker
3. Speaker
4. Keyboard FPC cable



Remove Camera

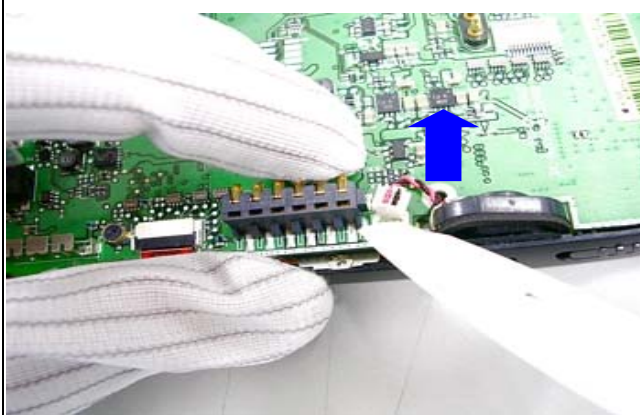

Remove speakers



Both side speakers are removed



Disconnect keyboard FPC cable

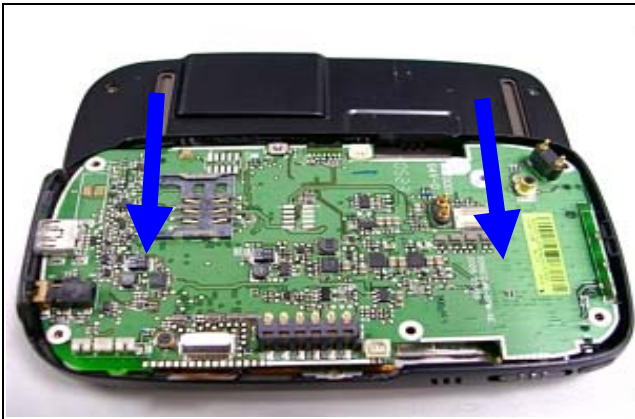

Shift the Keypad bezel as left picture

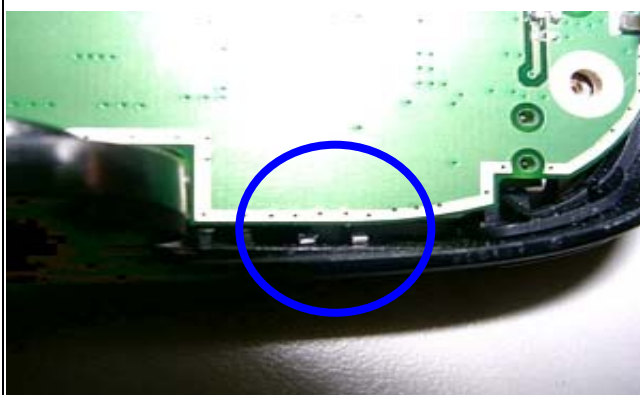

Take care the record button while disassembly main board

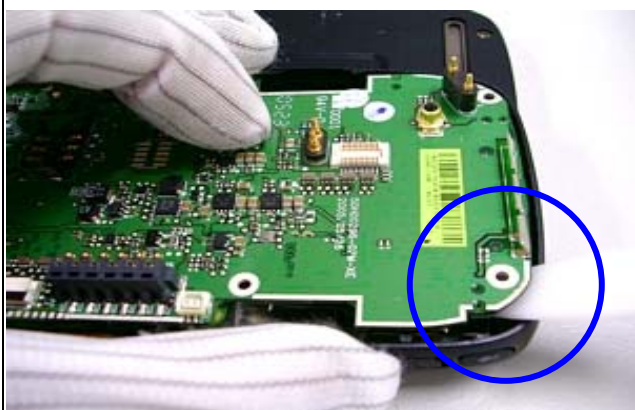

Use plastic stick to raise main board

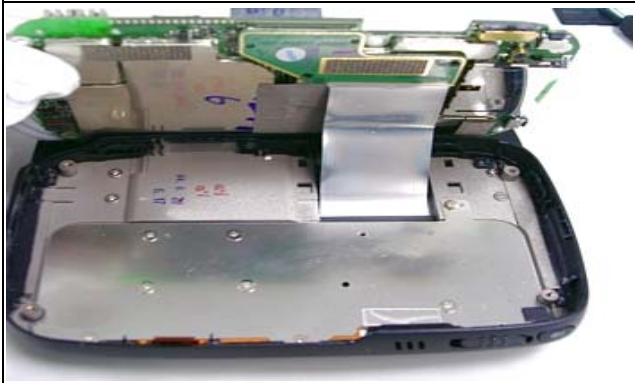

The main board is connected with Rigid-Flex Board

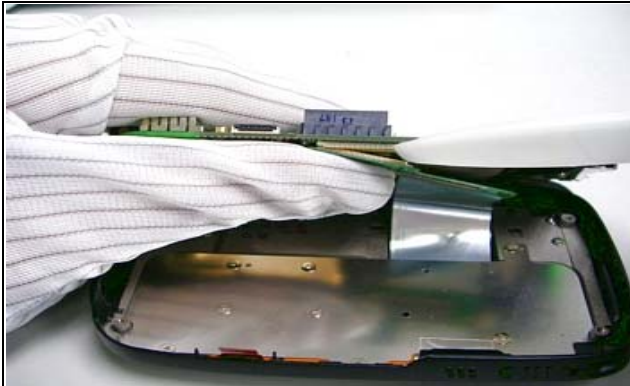

Disconnect the FPC cable



The main board is released

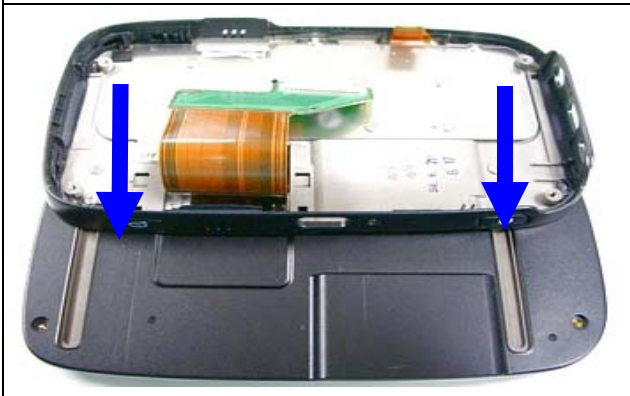

Shift the keypad bezel back

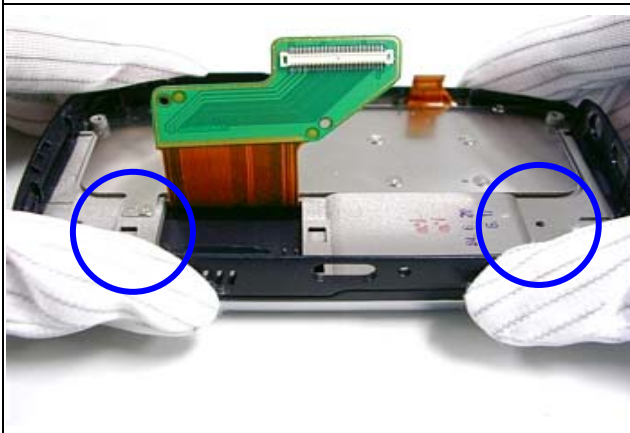

Disassembly 4 screws on both sides.



Disassembly keypad bezel of keyboard

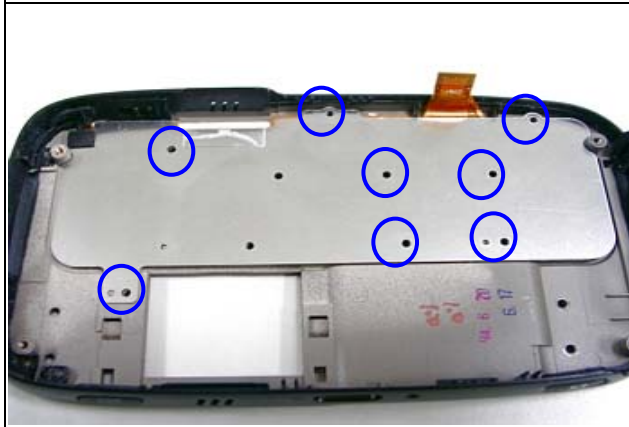

Remove 8 screws

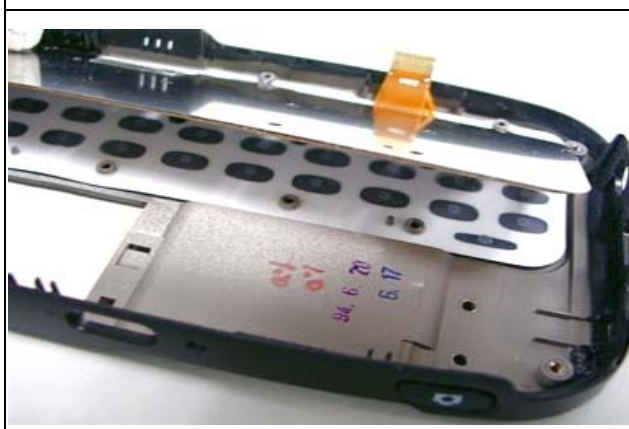

Disassembly keyboard



Keyboard and keypad are moved

Caution:
Don't need to separate FPC keyboard and metal plate



Remove 4 screws



Use plastic stick to unlock the hook

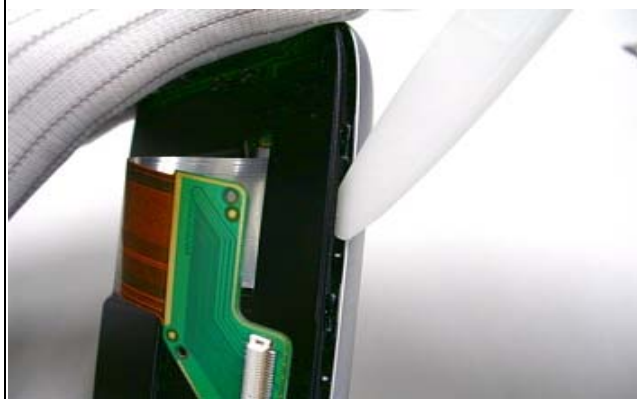

There are 6 hooks at both side, and 2 hooks at top and bottom side



Unlock another side



Let FPC cable through the space of Housing case, Separate LCM housing and LCM Bezel



Remove protect tape of LCM connector from the Rigid-Flex Board

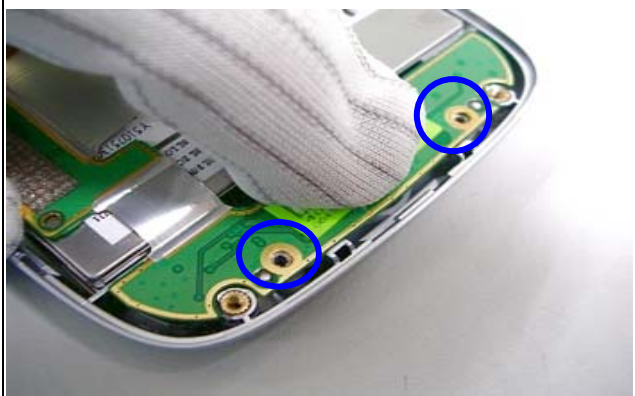

Remove 2 screws of top side from Rigid-flex board

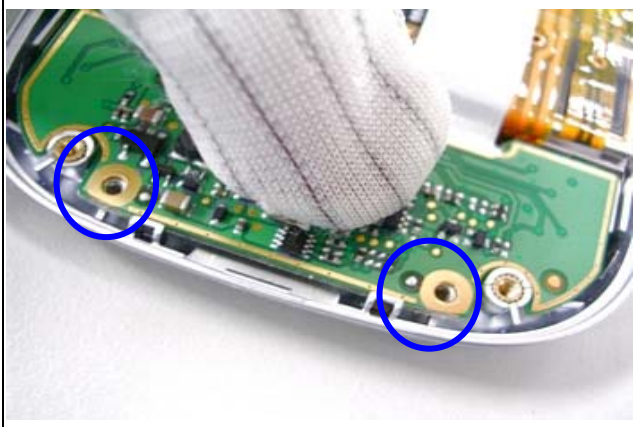

Remove 2 screws of bottom side from Rigid-flex board

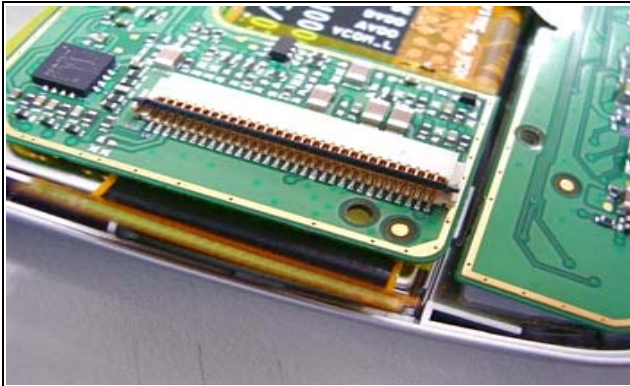

Disconnect LCM FPC cable



Disassembly Rigid-Flex Board



Disassembly LCM from LCM Bezel



Disassembly Receiver



Disassembly AP keypad and Navigation keypad



Disassembly process is done



The Unit Disassembly is done



5.2 Assembling

	<p>Make sure sponges and Mylar, Gasket,... are stuck in the main board</p> <ol style="list-style-type: none"> 1. 76H01061-00M * 1 2. 72H01048-00M * 1 3. 72H01049-00M * 1 4. 72H01065-00M * 2
	<p>Assembly AP keypad to LCM bezel</p>
	<p>Assembly Receiver to LCM Bezel</p>
	<p>Assembly Navigation keypad to LCM bezel</p>

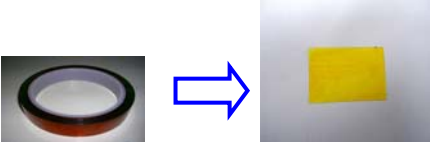

	<p>Assembly LCM to LCM Bezel</p>
	<p>Top site – Rigid-Flex BD Check and make sure following Gasket have been stick on the Rigid-Flex BD Gasket * 2; p/n :72H01135-00M</p> 
	<p>Back site – Rigid-Flex BD Stick 3 gaskets for Rigid-Flex BD Gasket * 3; p/n :72H01135-00M</p> 
	<p>Stick anti-short tape * 1 ; p/n: 76H01036-00M</p> 

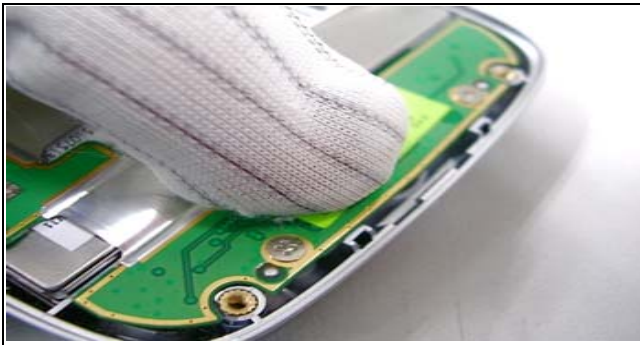

Install 2 screws to fix top side of Rigid-Flex Board

Torque : 0.6 +- 0.05 kgf-cm



Install 2 screws to fix bottom side of Rigid-Flex Board

Torque : 0.6 +- 0.05 kgf-cm

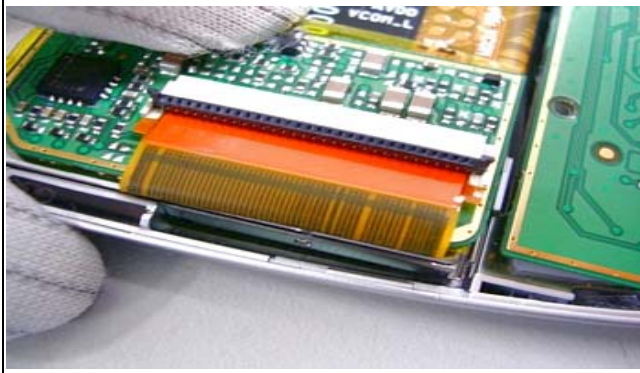

Connect LCM FPC cable to Rigid-Flex board

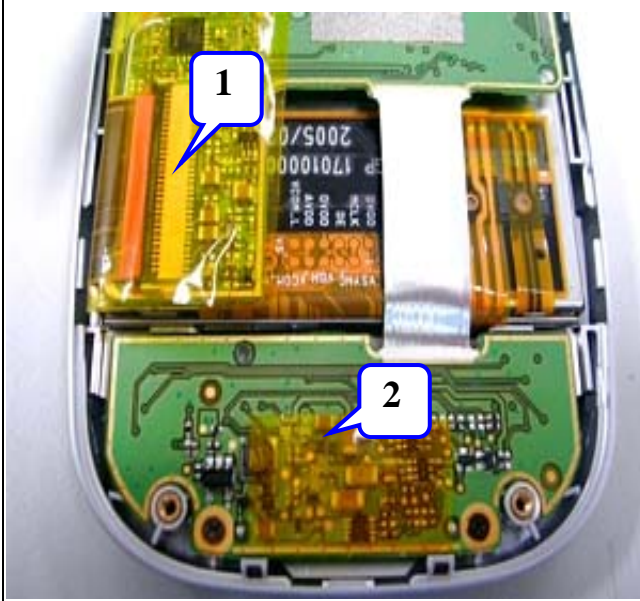

Once the Rigid-Flex BD is assembled, Please stick 2 anti-short tapes

1. Anti-short tape for LCM connector * 1
p/n: 76H01036-00M

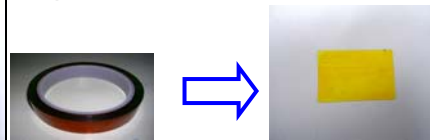

2. anti-short tape for Navi key * 1

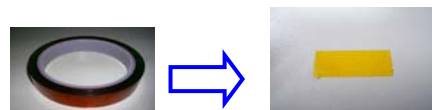



Assembly LCM housing

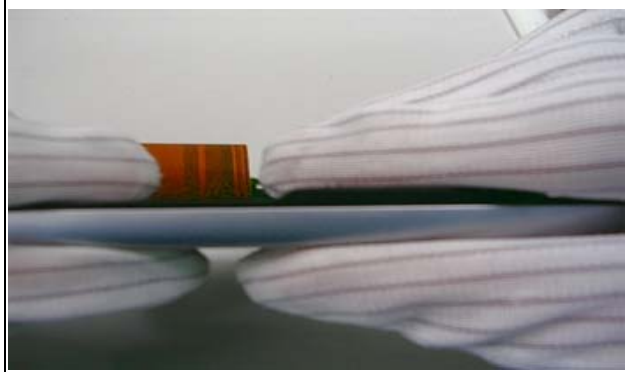

Use finger and thumb to press the hook



Make sure no gap



Install 4 screws

Torque : 0.8 +- 0.05 kgf-cm



Shift the slide pillar in the place



Assembly Qwerty keypad to keypad bezel

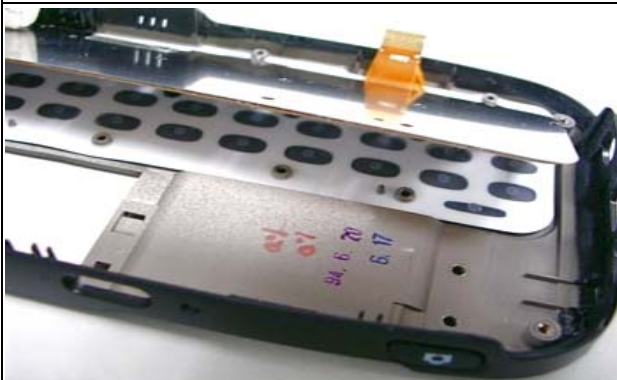

Assembly FPC keyboard

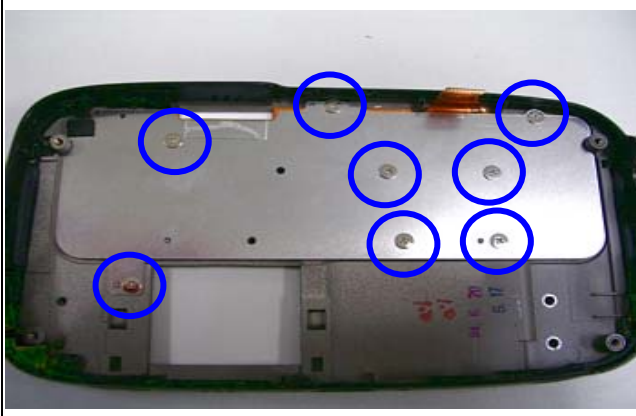

Install 8 screws to fix keyboard with keypad bezel

Torque : 0.55 +- 0.05 kgf-cm (low spin power)



Assembly the Keypad bezel to LCM housing

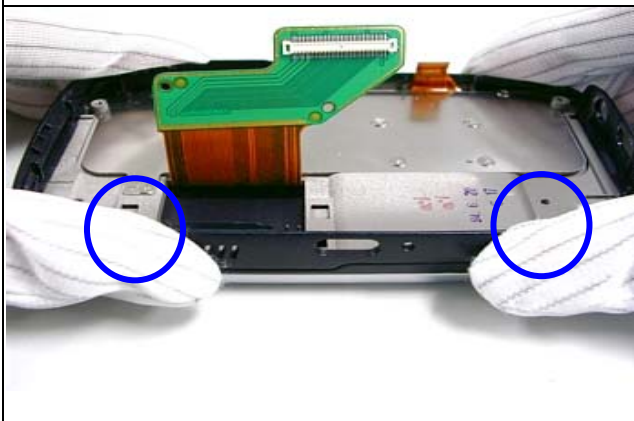

Install 4 screws on both sides

Torque : 1.0 +- 0.08 kgf-cm



Shift the position as left picture



Assembly Microphone rubber

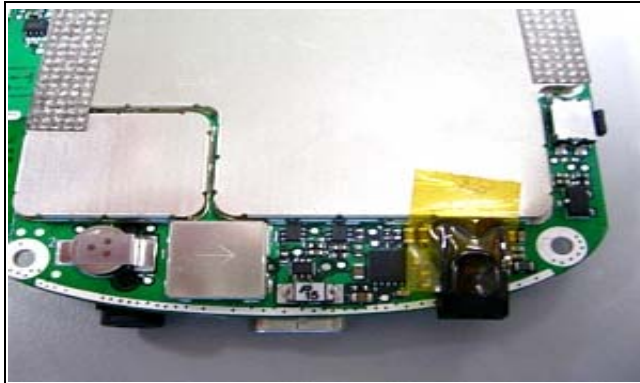

Stick a tape to fix microphone rubber



Connect FPC cable

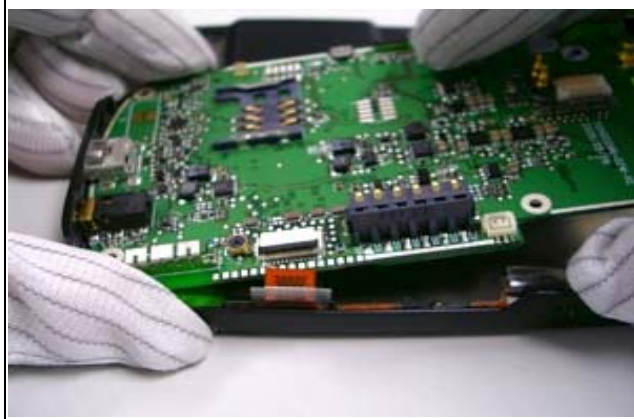

Assembly main board to keypad bezel



Make sure mini-USB connector and Audio jack is in place

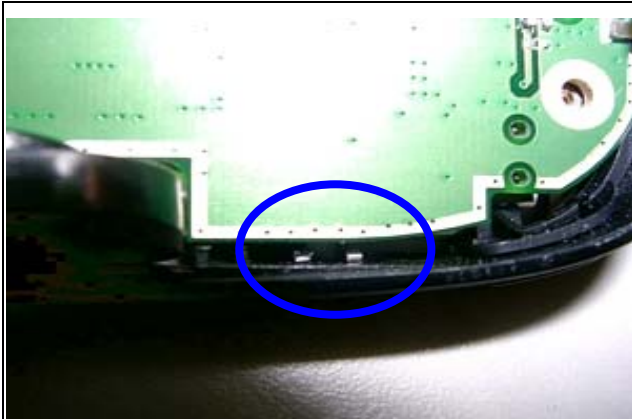

Take card the volume control switch while put the main board into the keypad bezel

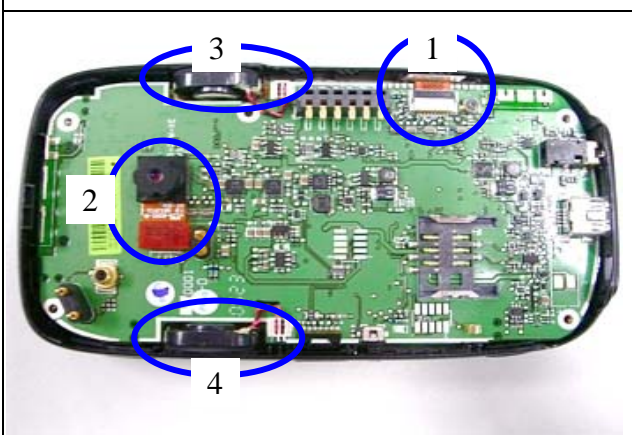

Following need to be assembly

1. Keyboard FPC cable
2. Camera
3. Speaker
4. Speaker

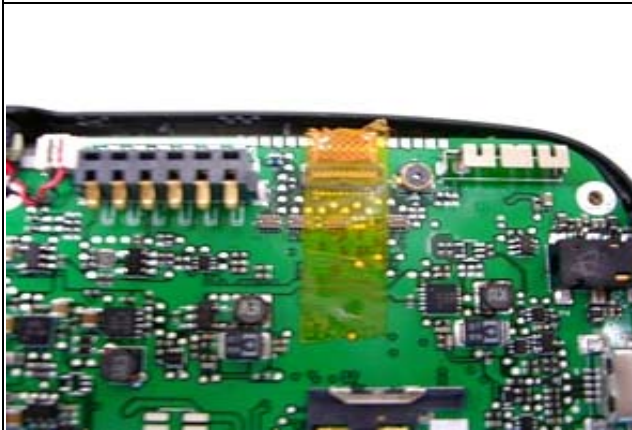

Stick an tape to fix the Keyboard cable

p/n: 76H01138-00M

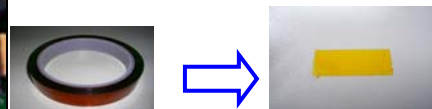

Assembly flash-light module to keypad housing



Assembly Vibrator to keypad housing



Assembly keypad housing



From bottom to top side while assembly



Use finger and thumb to press the hook



Put strap holder in the position



Install 4 screws
Torque : 1.1 +- 0.05 kgf-cm



Assembly Antenna cover, two hooks must be paired first

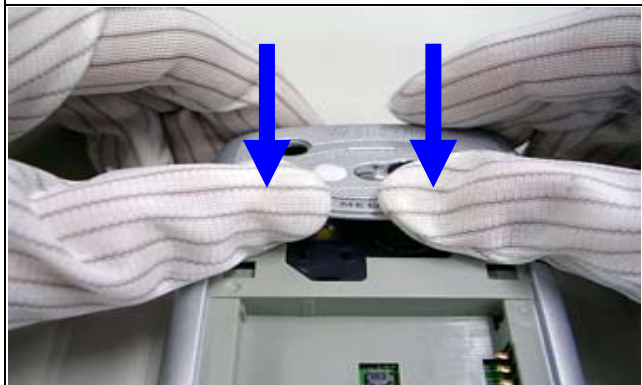

Push the Antenna cover from top side

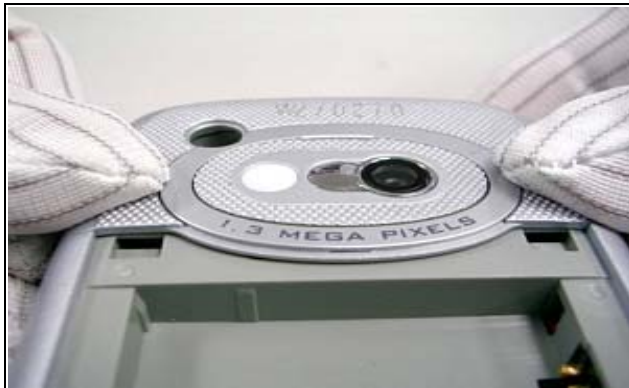

Use both thumbs to press the Antenna cover



Put the Battery into its place.



Warning: To reduce risk of fire or burns, do not disassemble, crush, puncture, short external contacts, or dispose of in fire or water. Replace only with specified batteries. Recycle or dispose of used batteries properly



Assembly battery cover.



Assembly process is done

Now The unit is ready for performing TEST.

The Unit assembly is done and ready for further tests.



5.3 Notification once performing Golden cap replacement

If you are authorized by HTC for board level component replacement, and if you perform M/B replacement, must take care for following notices:

Caution: Golden cap is easy to be damaged during board level repair, if you need to do board level repair, please follow the detail instruction as follows

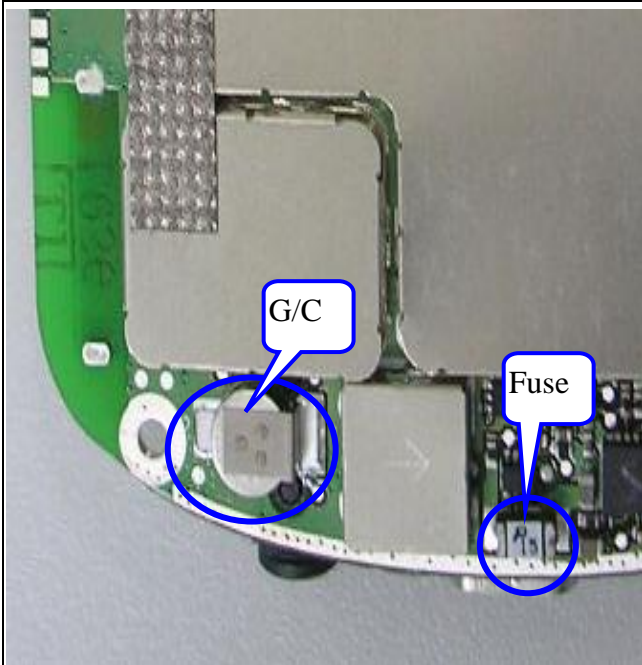
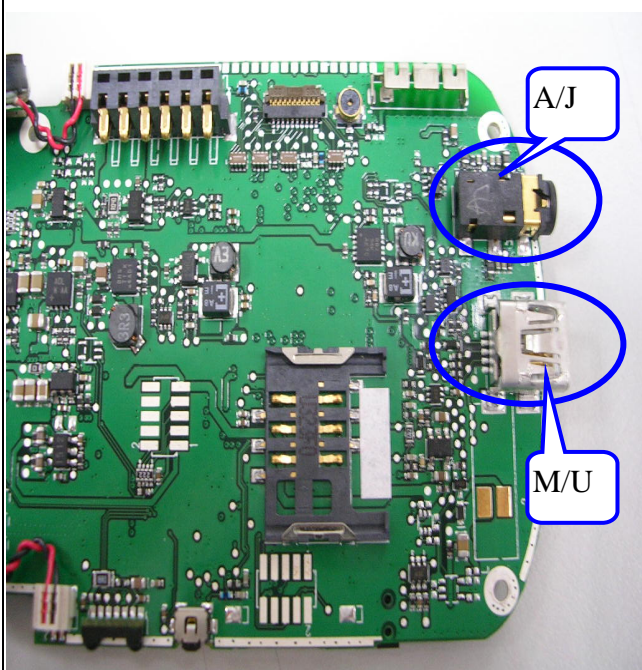
Please remove the G/C **First** before replacing following component

No	HTC P/N	Description	Location
1	36H00301-00M	Fuse,PTC,1.5A	PTC1
2	36H00305-00M	Audio Jack	ACON1
3	75H00379-00M	Mini USB	CON7

Criteria of soldering

- *.The temperature of Solder Iron must be under 350°c
- *.The heating time of Solder Iron must be under 5 seconds
- *.Solder iron can not have contact with Golden capacitor during soldering period, please prevent the solder iron contact to body of Golden capacitor.

Once above indicated component is replaced, please replace a new G/C to main board, NOT ALLOW to re-use the original unsoldered G/C.



5.4 Notification once performing M//B replacement

If you are authorized by HTC for board level component replacement, and if you perform M/B replacement, must take care for following notice:



Warranty Seal (Security Label)
Be sure to apply new Warranty seal once the unit has been repaired before sending back to customer.

Stuck position: under Antenna cover as left photo



Liquid Damage label (Water Indicator)
Be sure to apply new liquid damage label once the unit has been repaired before sending back to customer.

Stuck position: under SIM connector as left photo



In case of MB replacement, since the IMEI has to follow new MB IMEI, repair site is required to re-print Regulatory label to change IMEI no, but Serial no. must remain unchanged.

Label format : according customer request, detail please refer to section 3 - labeling



5.5 Notification once performing LCM replacement

There are 2 sources of LCM and Rigid-Flex board, the 1st source of LCM must match that of 1st source of Rigid-Flex board. The same rule is applied for 2nd source of LCM and Rigid-Flex board as well. Repair center is requested to check original used component before replacing LCM or Rigid-Flex board,

For example below:

Original used LCM is 1st source of 60H00032-00 and verified result is fail, Must be replaced with same p/n 60H00032-00, The match table is as follows.

80H00418-00 to match with 60H00032-00 only (Samsung LCM)

80H00418-01 to match with 60H00037-00M only (Toppoly LCM)

1 st source	80H00418-00 (51H10045-00M)	Rigid-Flex Board ASSY, for Samsung LCM	60H00032-00	LCD Module, Samsung
2 nd source	80H00418-01 (51H10045-01M)	Rigid-Flex Board ASSY, for Toppoly LCM	60H00037-00M	LCD Module, Toppoly,

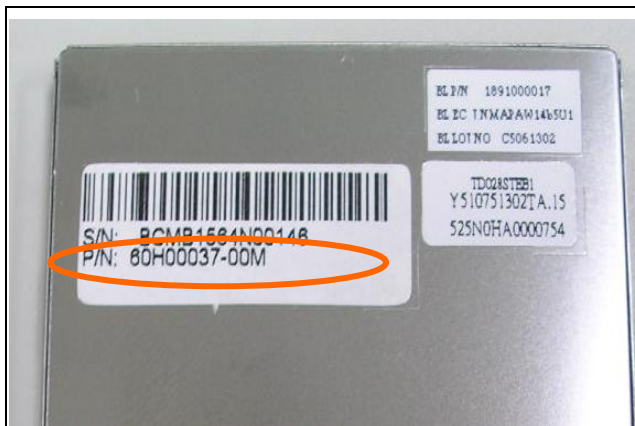

Check LCM p/n:

1st source: 60H00032-00, Samsung LCM

2nd source: 60H00037-00M, Toppoly LCM

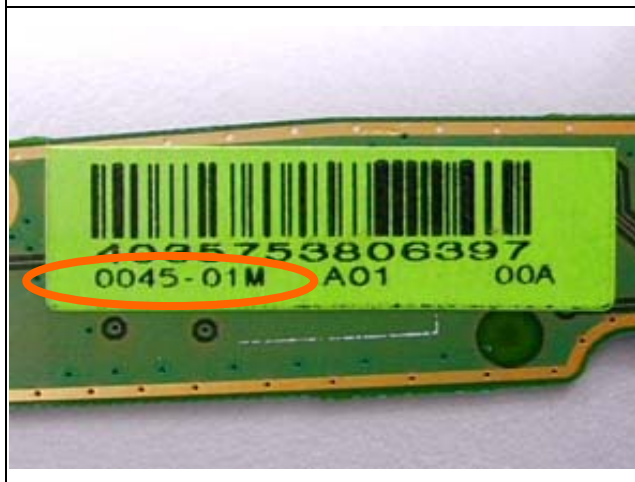

Check Rigid-Flex Board p/n:

1st source: **80H00418-00 (51H10045-00M)**
for Samsung LCM(60H00032-00M)

2nd source: **80H00418-01 (51H10045-01M)**
for Toppoly LCM(60H00037-00M)







5.6 Notification once performing Rigid-Flex board replacement

There are some isolation tape are stuck in the rigid-flex board, repair center is requested to follow below process once performing rigid-flex board replacement.

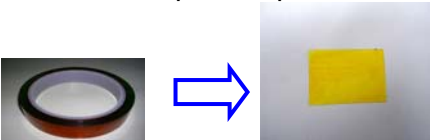
80H00418-00 = 51H10045-00M (Rigid-flex BD) + 72H01135-00M(Gasket* 5) for Samsung LCM

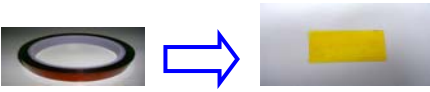
80H00418-01 = 51H10045-01M (Rigid-flex BD)+ 72H01135-00M (Gasket* 5) for Toppoly LCM

	<p>Top site – Rigid-Flex BD</p> <p>Make sure there are 2 gaskets stuck on the Rigid-Flex BD then stick an isolation tape</p> <ol style="list-style-type: none"> 1. gasket * 2; p/n :72H01135-00M  <ol style="list-style-type: none"> 2. Isolation tape * 1 ; p/n: 76H01036-00M 
	<p>Back site – Rigid-Flex BD</p> <p>Make sure there are 3 gaskets stuck on the Rigid-Flex BD</p> <p>Stick 3 gaskets for Rigid-Flex BD</p> <ol style="list-style-type: none"> 1. gasket * 3; p/n :72H01135-00M 
	<p>Back site – Rigid-Flex BD</p> <p>Once the Rigid-Flex BD is assembled, Please stick 2 isolation tapes</p> <ol style="list-style-type: none"> 1. Isolation tape for LCM connector * 1 p/n: 76H01036-00M  <ol style="list-style-type: none"> 2. Isolation tape for Navi key * 1 



5.7 Notification once performing LCM housing or Keypad bezel replacement

There are 2 sources of LCM housing and Keypad bezel, the 1st source of LCM housing must match that of 1st source of keypad bezel. The same rule is applied for 2nd source of LCM housing and keypad bezel as well. Repair center is requested to check original used component before replacing LCM housing or Keypad bezel

For example below:

Original used LCM housing is 1st source of 74H00498-0XM and verified result is fail, Must replace same p/n 74H00498-0XM of 1st source, The matching table and identify features are as follows

74H00498-0XM to match with 74H00499-0XM only

74H00498-5XM to match with 74H00499-5XM only

	1 st source (Taiwan Vendor)	2 nd source (Chain Vendor- Nypro)
LCM housing	74H00498-0XM	74H00498-5XM
Hook	White	Black
Marked	A 、 B 、 C	1 、 2

1st source (74H00498-0XM)

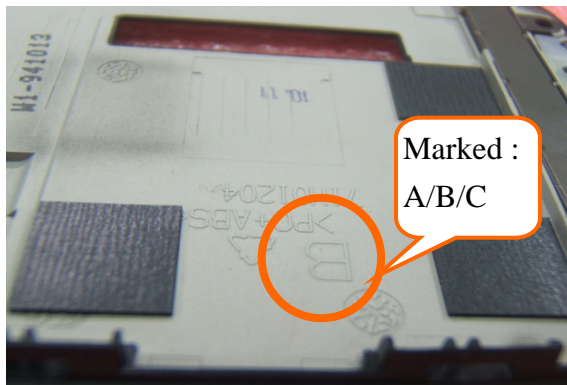
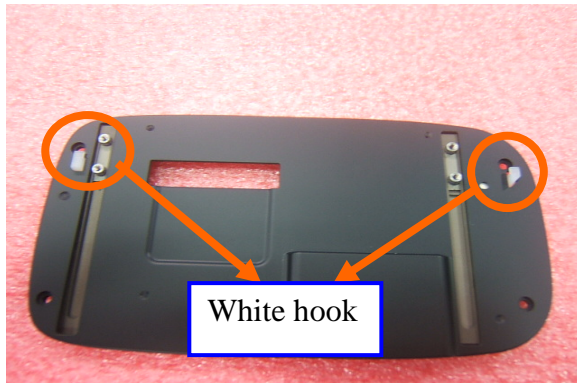

2nd source(74H00498-5XM)

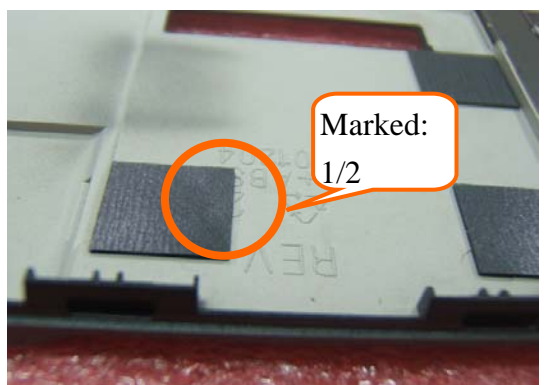
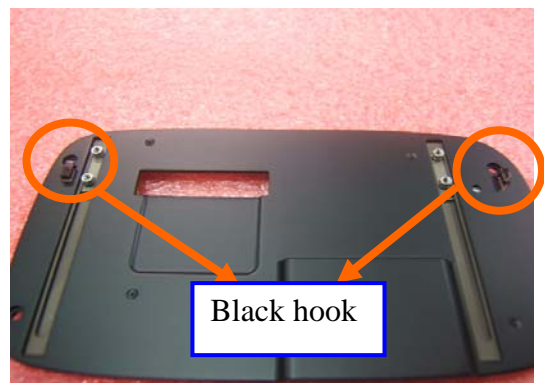



	1 st source (Taiwan Vendor)	2 nd source (Chain Vendor- Nypro)
Keypad bezel	74H00499- 0XM	74H00499- 5XM
Marked	A 、 B 、 C	1 、 2

1st source (74H00499-0XM)

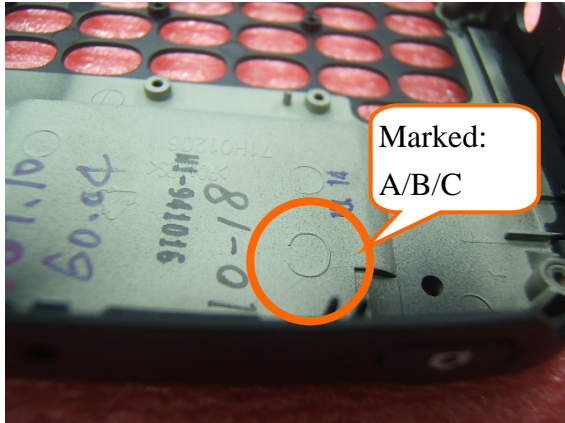

2nd source(74H00499-5XM)

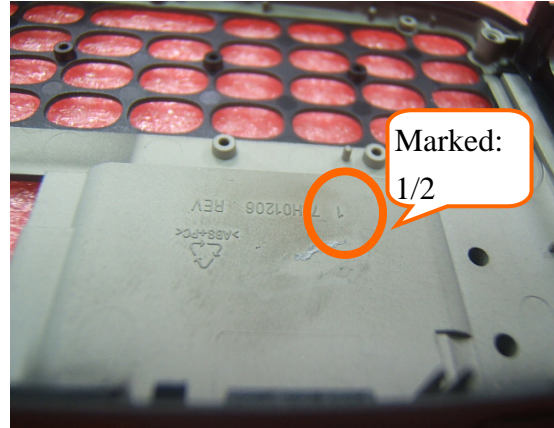



6. Equipment of Problem Diagnostics

6.1 List of Test Jigs

Item Name	Usage	Remark
USB to Mini USB Cable/Cradle	For Sync test ; RUU re-flash ROM image	
Special Plastic Tool	For unit disassembly	
Hand tools	For unit disassembly	
AC Adapter	For battery recharge and power related tests	
Earphone with Microphone	For audio test	
Mini SD card with diagnostic	For Function	Program designed by HTC
PC or Notebook	Use for Communication/Synchronization test	

6.2 Hardware Requirement for PC

- O.S.: Windows 2000 above
- CPU: Pentium 166MHz or above
- Memory: 64MB~128MB

6.3 Software Requirement

- Microsoft Active Sync **version 4.0 above**
- Diagnostic Program loaded on Mini SD card. (encoded by HTC)



7. Diagnostic Program

7.1. List of Test Items

No.	Item	Description	Remark
	Function Test		
	Auto Test	All manual test tem for 1 loop	
	SDRAM Test	RAM Check Size/Write/Read/Comparison test.	
	Display Test	Test the LCD display quality.	
	LED Test	Test the message LED.	
	Back Light Test	Back light ON with in different brightness level.	
	Timer	Check Time setting	
	SD Test	SD card Write/Read/Write Protect test.	
	Vibrator Test	Test the function of the vibrator.	
	Key Test	Test every most of button.	
	Flash Light Test	Flash light at Video and Capture mode	
	Qwerty Test	All the key of Qwerty Test	
	Slide Test	Check Slide key	
	SPK Play	Internal Speaker test.	
	Receiver Play	Internal Receiver test.	
	Hst Play	External headset Speaker test.	
	Int Rec –Spk out	Internal Microphone and internal Speaker test.	
	Int Rec –Rev out	Internal Microphone and internal Receiver test.	
	Int Rec –Hst out	Internal Microphone and external Speaker test.	
	Hst Rec –Hst out	External headset Microphone and external Speaker test.	
	View Checksum	Manufacture use only	
	SIM information	Manufacture use only	
	ROM to SD	Manufacture use only	
	Run – in Test	All auto function test for option : 1/2/4/8 hrs	
	Device info	Check unit information, For example : Customer's ID	
	Clear Talk time	1. Clear talk time recode in WinCE system information 2. Clean all PIM(personal information manage) storage CAUTION: This item is applied for refurbishment case only. If the unit is repaired and will send back to original customer, It is unnecessary to perform clear talk time	Notice : Refurbish ment only
	Diag to SD	Copy Diag program to another encoded mini SD card	



7.2 Test Items Operation

How to Enter Test Mode

Caution: Diagnostic Card must match with unit's SPL version, Detail please refer to last page, section 14, Diagnostic card vs. unit's SPL version

- >Insert mini-SD card (with Diagnostic program pre loaded sent by HTC) into Min- SD slot
- >Power on the unit. While **press** and **hold** the **Capture button** and **Reset** the unit with stylus, release **Reset** button first about 1 second to enter test Mode. You will find the HTC main page as follows



- >Press Action button enter test detail item



7.3 How to execute Diag. test program:

- Using navigation button -"Up" or "Down" to select the test items
- Using navigation button -"Left" or "Right" to change page
- Press "Action" to execute testing

Caution: Don't format diagnostic card once you enter Win CE mode



8. Main battery Test procedure

8.1: Certification flow

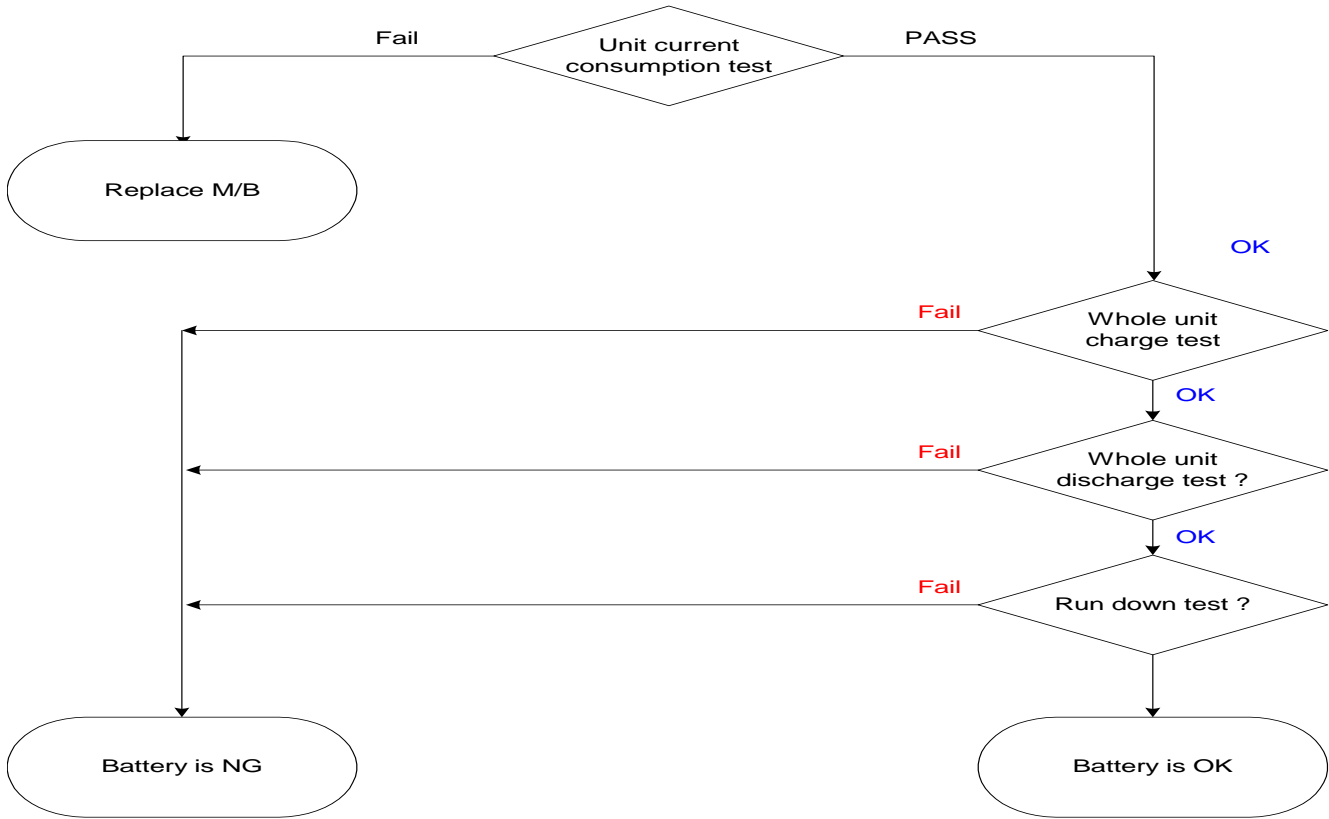



8.2 Current consumption measurement



- 1. Equipment requirement**
- A. Power Supply (set at 4 V /1A).
 - B. Micro-Current Meter (support 0.5mA ~ 1A at least).

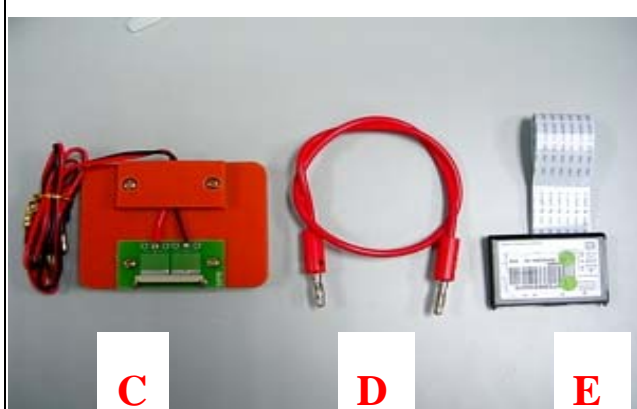

- 2. Fixture requirement**
- C. Current series jig.(with black and red cable)
 - D. Cable
 - E. Battery with extension cable



- 3. Connect cable (D) to positive polarity of power supply (A) and current meter (B)**

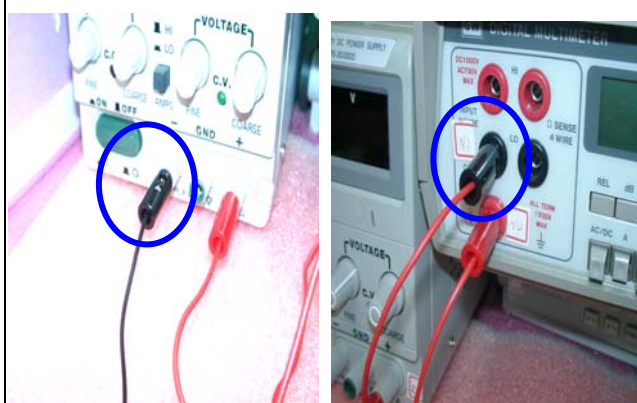

- 4. Connect cable of fixture(C) to negative polarity of power supply (A) and current meter (B)**

Note : black cable to power supply (A) and red cable to current meter (B)



5. Install battery fixture (E) to unit



6. Ready for testing
(Don't turn on power at the moment)



7. Turn on power supply (4V)

8. Turn on current meter (2A)

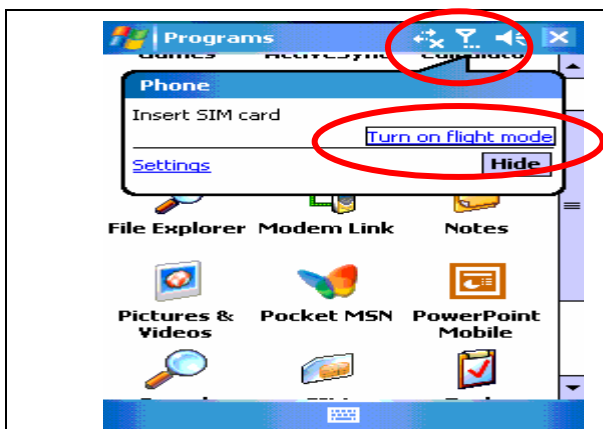

9. Press Power button to turn on the unit

10. In "main page", Check phone status, Click "Turn on flight mode"

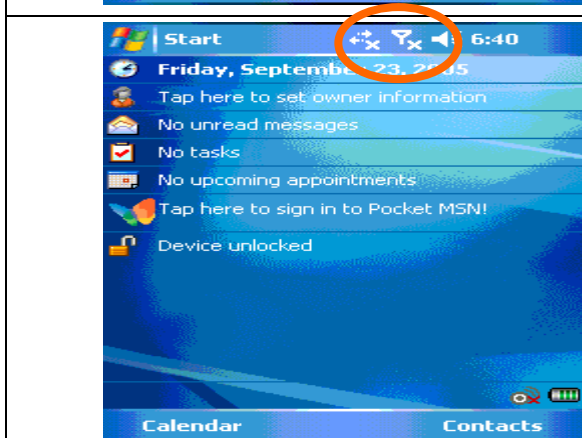

11. Make sure all the RF function is closed already



12. Turn off back light, the current will be showing on current meter, this status is so called "idle mode", The criteria is as follows
 $\leq 108 \text{ mA}$

Unit is still turned on but no back light



13. After idle current checked, press power button then release soon, the power will be off, this status is so called "sleep mode"
 The criteria is as follows

$\leq 6 \text{ mA}$

Unit is turn off and no display



8.3 Whole unit charge and discharge test

	<p>1. Whole unit charge test Plug in AC adapter to unit.</p>
	<p>The charge light must be turn on, If it is failed in charge test, replace another good battery for double check.</p>
	<p>2. Whole unit discharge test Unplug AC adapter,</p>
	<p>The charge light must be off, but the LCD screen must still on display. If it is failed in discharge test, replace another good battery for double check.</p>



8.4 Battery Performance on unit with Run Down Program

<ul style="list-style-type: none"> -> Copy Run Down software "power detect" ; "model.txt" and "Setbacklight.dll" to SD card -> Make sure turn off all RF function (BT/WLAN/GSM) setting already before executing Run down test. -> Execute power detect 	
<ul style="list-style-type: none"> -> Check phone status, Click "Turn on flight mode" 	
<ul style="list-style-type: none"> -> Make sure all the RF function is closed already, the icon must be as right photo 	



-> Enter to SD card (Setbacklight.dll is a hide file)
-> Execute PowerDetect

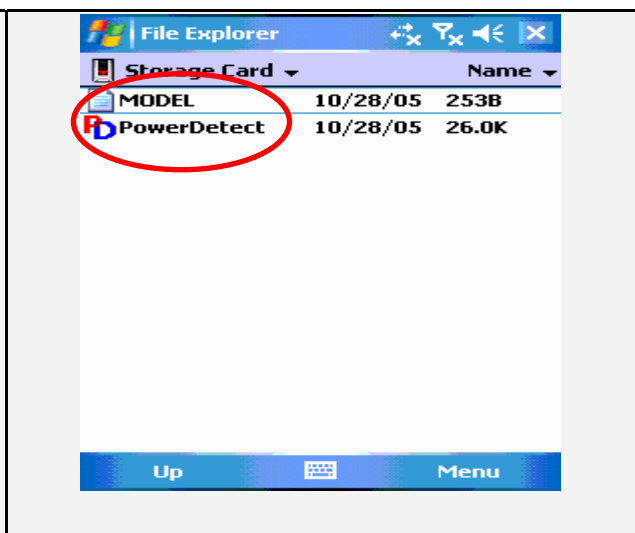

-> choose right model : Prodigy

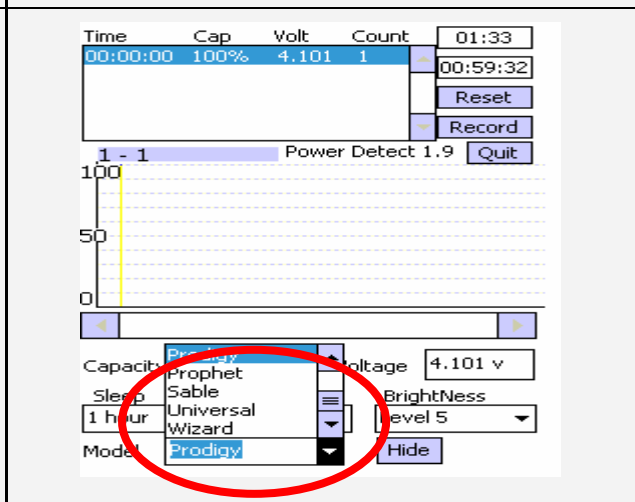

-> Check the backlight status, please click level 5 again even the default setting is level 5 already. The propose is to confirm back light 100% already
-> Default setting are
Sleep : 1 hour
Record : 2 minutes
It means the program will be turn off after 1 hour and detecting battery status by per 2 minutes

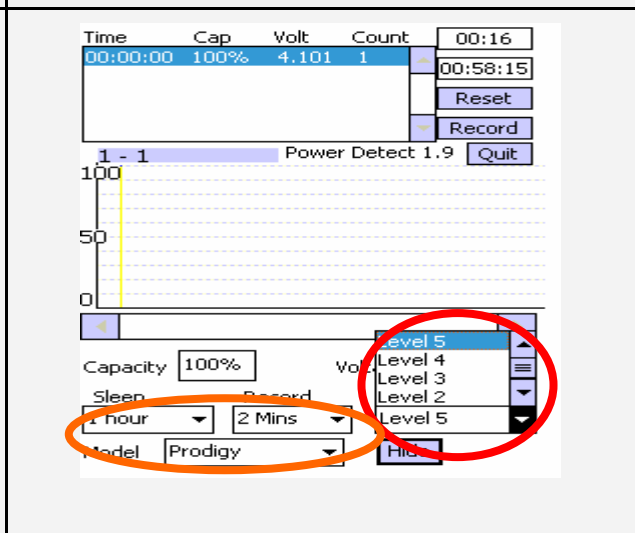



-> After one hour later the program will stop, open the log file of PowerCap.txt. Please check battery remaining capacity.

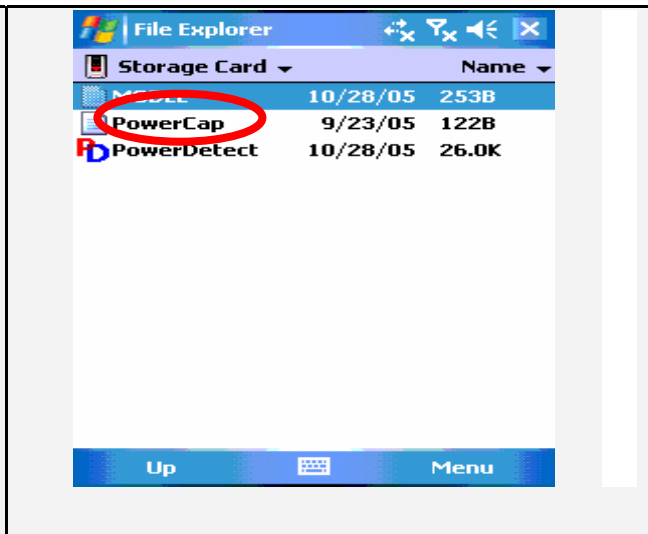

Check remaining percentage of battery at time 00:00:XX

The criteria is as follows:
 >=65 %

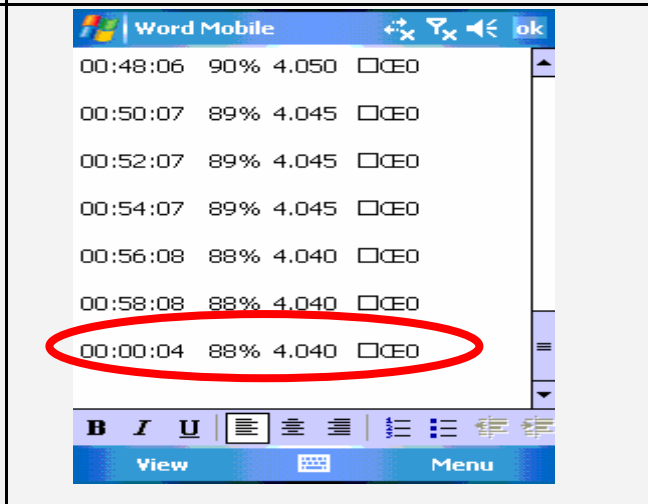



-The flow chart is as follows.

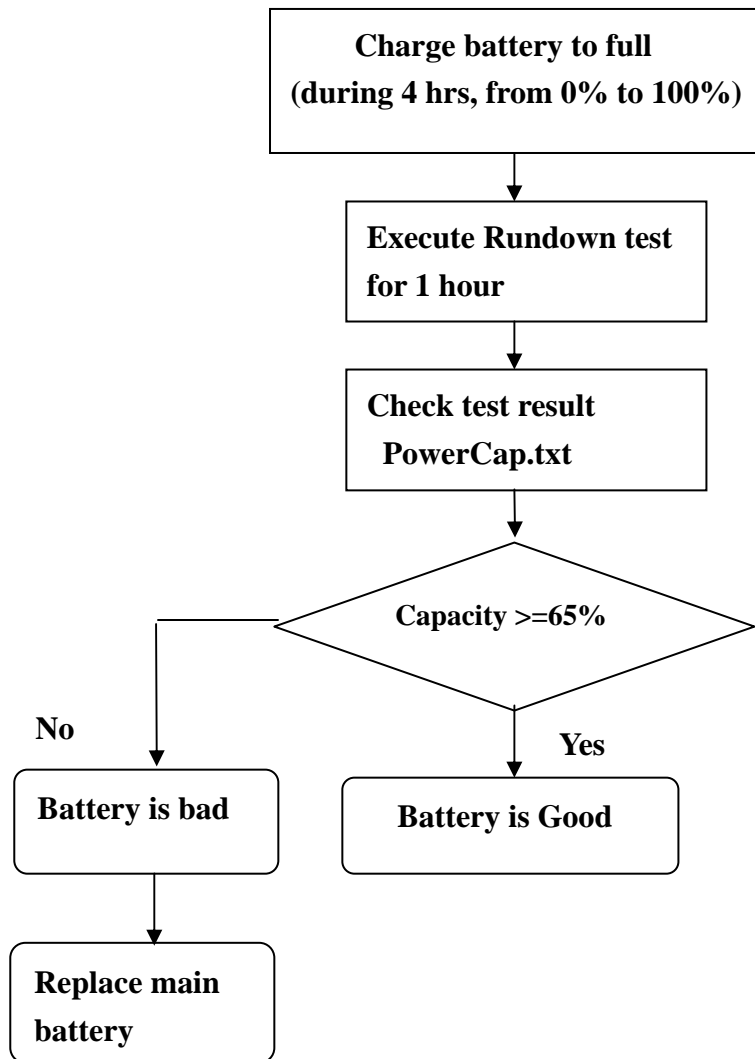



9. LCM Inspection Criteria (For New LCM only)

Inspection Defects		Accept Level	
電氣特性 Electrical Characteristic Defects	1. 亮點 Bright Dots	單點 Single	紅點+綠點+藍點 ≤ 3 Red+ Green+ Blue ≤ 3 S ≥ 5 mm.
		兩個相鄰點 2 adjacent	0
		三個或三個以上的相鄰點 3 or more adjacent	0
	2. 暗點 Dark Dots	單點 Single	總數 ≤ 2 Total Number ≤ 2 S ≥ 5 mm.
		兩個相鄰點 2 adjacent	0
	3. 暗或亮線 Dark or Bright lines		0
	4. 所有可允許的點 All Allowable Dots Defects		總數 ≤ 3 Total Number ≤ 3 S ≥ 5 mm.
5. 螢幕顯示區偏移傾斜 Shift and tilt of screen viewed area		與上蓋之四周間隙 > 0.2 mm Around gap distance the bezel > 0.2 mm	
刮傷, 外來物 或毛屑 Foreign Scratch, Objects or Lint 未開機狀態 On power off status	1. 刮傷 Scratch	$0.03 < W \leq 0.1$ (mm) $L \leq 5$ (mm) $N \leq 2$,	
	2. 毛屑(線性外來物) Lint (linear foreign objects)	$0.03 < W \leq 0.1$ (mm) $0.3 < L \leq 3.0$ (mm) $N \leq 5$,S=15mm	
	3. 顆粒 Spots	$0.1 < D \leq 0.3$ (mm) $N \leq 4$, S=15mm	
	4. Fish eye on film	$0.1 < D \leq 0.4$ (mm) $N \leq 4$,	
	牛頓環 (Newton Ring)	Limit Sample,N ≤ 1	



半透明物質沾污 (Semitransparent material)	不允許 (Not allowed), $N \leq 0$
5. 表面破裂 Breakage on film surface	Not acceptable
6. 全部可允許之不良點數 ≤ 10 點 Total acceptable defect quantity ≤ 10	



10. RF Test

10.1 GSM function test

For RF antenna test, you need to set up your mobile tester, Antenna coupler and Shielding box to meet HTC specification and requirement.

10.2 Hardware Requirement:

1. Mobile Tester.
2. Plane Antenna
3. Test Jig.
4. Shielding Box
5. RF golden sample
6. RF cable

10.3 RF test connection (following is a example of HTC RF test solution)

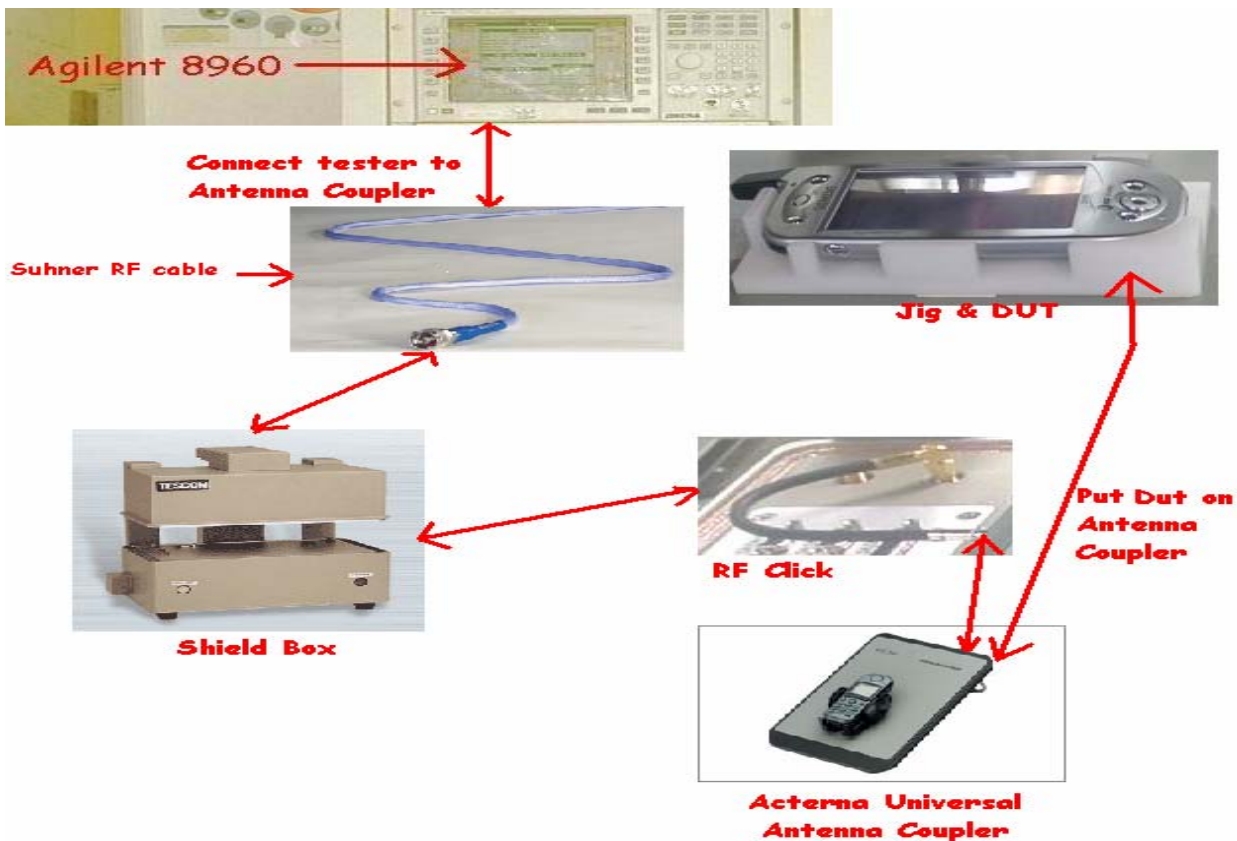



10.4 RF Antenna specification

Item	Test Name	Tx level	TCH	1 st Download cell power	Note
1	Camp @DCS Band	0	512	-75	BCH=600
2	BS Originate call	0	512	-75	
E-GSM 900 RECEIVER TEST					
3	Fast Bit Error Rate	5	975	-104	
4	Fast Bit Error Rate	5	42	-104	
5	Fast Bit Error Rate	5	124	-104	
E-GSM 900 Transmitter TEST					
6	TX Phase RMS Error	5	975	-104	
7	TX Phase Peak Error	5	975	-104	
8	TX Frequency Error	5	975	-104	
9	TX Phase RMS Error	5	42	-104	
10	TX Phase Peak Error	5	42	-104	
11	TX Frequency Error	5	42	-104	
12	TX Phase RMS Error	5	124	-104	
13	TX Phase Peak Error	5	124	-104	
14	TX Frequency Error	5	124	-104	
15	Check TX Power	5	975	-104	
16	Check TX Power	5	42	-104	
17	Check TX Power	5	124	-104	



DCS 1800 Receiver Test

1	Fast Bit Error Rate	0	512	-104	
2	Fast Bit Error Rate	0	698	-104	
3	Fast Bit Error Rate	0	885	-104	

DCS 1800 Transmitter Test

4	TX Phase RMS Error	0	512	-104	
5	TX Phase Peak Error	0	512	-104	
6	TX Frequency Error	0	512	-104	
7	TX Phase RMS Error	0	698	-104	
8	TX Phase Peak Error	0	698	-104	
9	TX Frequency Error	0	698	-104	
10	TX Phase RMS Error	0	885	-104	
11	TX Phase Peak Error	0	885	-104	
12	TX Frequency Error	0	885	-104	
13	Check TX Power	0	512	-104	
14	Check TX Power	0	698	-104	
15	Check TX Power	0	885	-104	



PCS 1900 Receiver Test					
1	Fast Bit Error Rate	0	512	-104	
2	Fast Bit Error Rate	0	661	-104	
3	Fast Bit Error Rate	0	810	-104	
PCS 1900 Transmitter Test					
4	TX Phase RMS Error	0	512	-104	
5	TX Phase Peak Error	0	512	-104	
6	TX Frequency Error	0	512	-104	
7	TX Phase RMS Error	0	661	-104	
8	TX Phase Peak Error	0	661	-104	
9	TX Frequency Error	0	660	-104	
10	TX Phase RMS Error	0	810	-104	
11	TX Phase Peak Error	0	810	-104	
12	TX Frequency Error	0	810	-104	
13	Check TX Power	0	512	-104	
14	Check TX Power	0	661	-104	
15	Check TX Power	0	810	-104	



GSM 850 Receiver Test					
1	Fast Bit Error Rate	5	128	-104	
2	Fast Bit Error Rate	5	189	-104	
3	Fast Bit Error Rate	5	251	-104	
GSM 850 Transmitter Test					
4	TX Phase RMS Error	5	128	-104	
5	TX Phase Peak Error	5	128	-104	
6	TX Frequency Error	5	128	-104	
7	TX Phase RMS Error	5	189	-104	
8	TX Phase Peak Error	5	189	-104	
9	TX Frequency Error	5	189	-104	
10	TX Phase RMS Error	5	251	-104	
11	TX Phase Peak Error	5	251	-104	
12	TX Frequency Error	5	251	-104	
13	Check TX Power	5	128	-104	
14	Check TX Power	5	189	-104	
15	Check TX Power	5	251	-104	

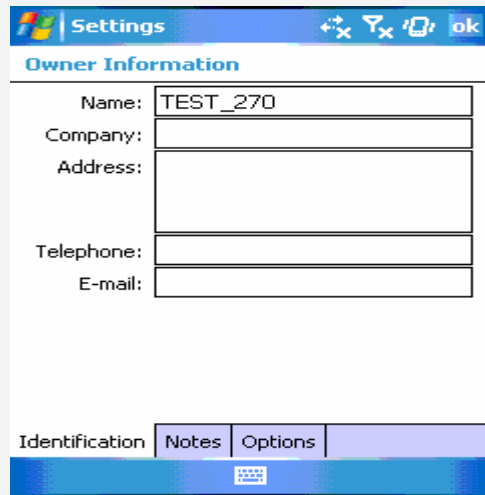
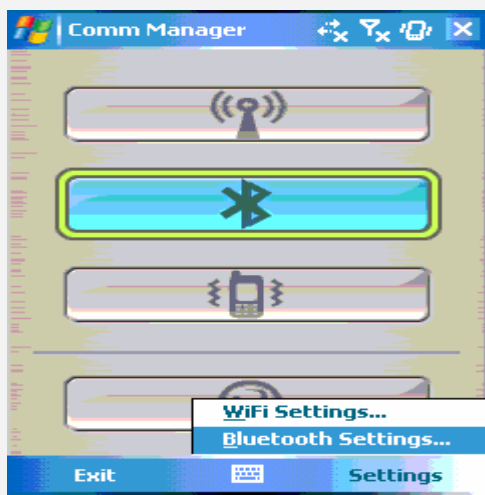
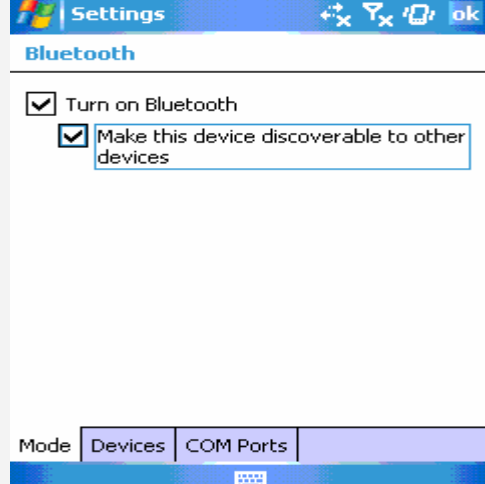

10.5 Bluetooth Function Test

<p>->Prepare Two units with BT function, One will be the UUT (unit under test) and the other one will be the Host unit (Source unit).</p> <p>->Named in Owner Information for Both devices</p> <p>Here is an example: Host device named "Test_270" UUT device named "Test_519"</p>	
<p>-> Turn on Bluetooth for both devices</p> <p>->Choose "Bluetooth Setting" for both devices.</p>	
<p>->Enable "Turn on Bluetooth"</p> <p>->Enable "Make this device discoverable to other devices" for both devices.</p>	



<p>-> Tap “ New Partnership...” in Host device</p>	
<p>-> In Host device, will find the UUT device (Test_519) and showing in the page</p> <p>-> In Host device, Tap “ Test_519”</p> <p>-> Tap “ NEXT”</p>	
<p>-> In Host device, Input passkey “ 0000”</p> <p>-> Tap “NEXT”</p>	



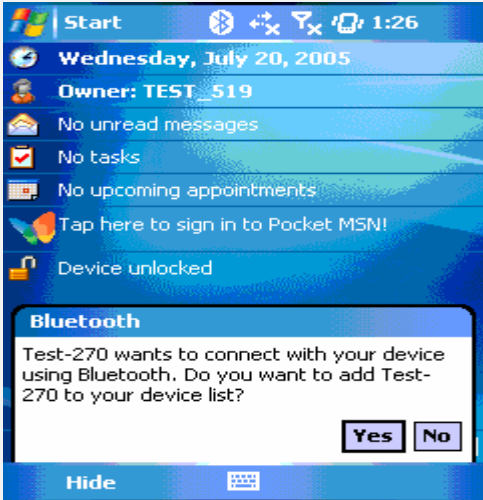
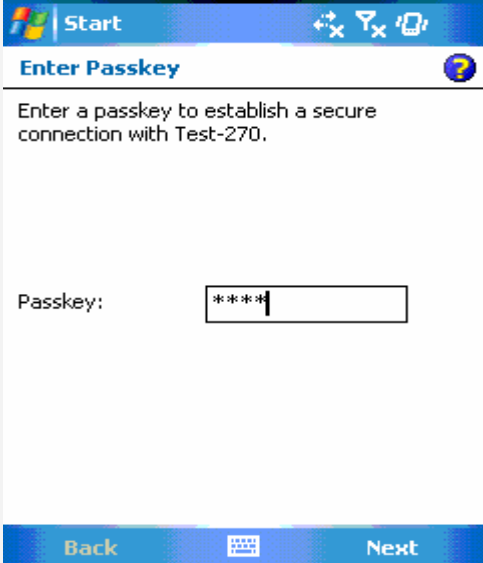
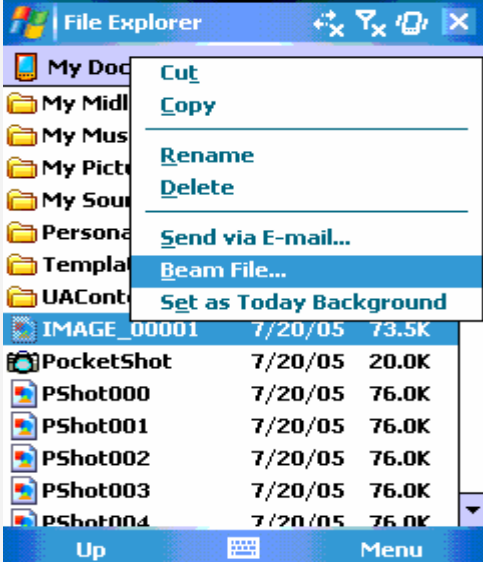

<p>-> In UUT (TEST_519), The Screen will appear an message</p> <p>-> Tap “YES”</p>	
<p>-> In UUT (TEST_519), The Screen will appear a request of passkey</p> <p>-> In UUT (TEST_519) , Input “0000”</p> <p>-> Tap “NEXT”</p>	
<p>-> In Host device (Test_270), choose a file (for example: Image_00001, then press and hold the file until appear sub-icon</p> <p>-> Tap “Beam file”</p>	

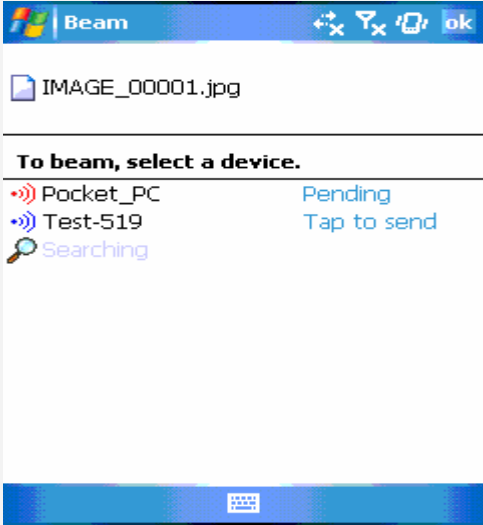
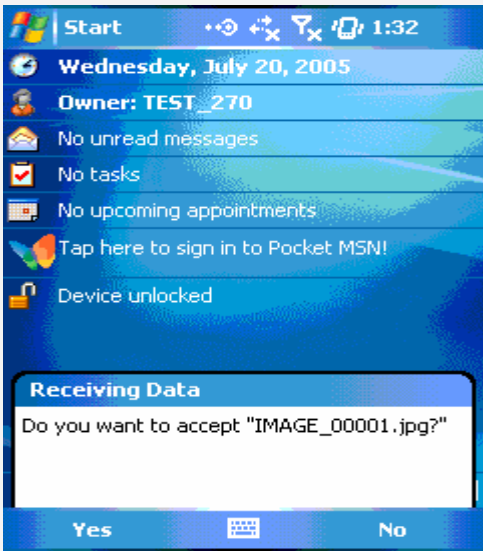
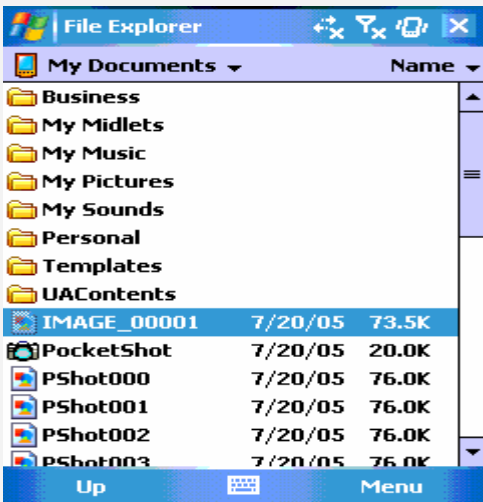



<p>-> In Host device, the screen will appear UUT "Test_519"</p> <p>-> Tap UUT "Test_519"</p>	 <p>The screenshot shows the Beam interface on a mobile device. At the top, it says "Beam" with a status bar. Below that, it displays "IMAGE_00001.jpg". A section titled "To beam, select a device." lists three options: "Pocket_PC" with a status of "Pending", "Test-519" with a status of "Tap to send", and "Searching".</p>
<p>-> In UUT(Test_519), The screen will appear message: Do you want to accept " Image_0001?"</p> <p>-> Tap YES</p>	 <p>The screenshot shows the Start screen of a mobile device. The date is "Wednesday, July 20, 2005" and the owner is "TEST_270". There are several status indicators: "No unread messages", "No tasks", and "No upcoming appointments". A "Receiving Data" dialog box is open at the bottom, asking "Do you want to accept 'IMAGE_00001.jpg?'" with "Yes" and "No" buttons.</p>
<p>->In UUT(Test_519), it must successful get a file " Image_00001" in the folder of My document.</p>	 <p>The screenshot shows the File Explorer interface. The "My Documents" folder is selected, and a list of files is displayed. The file "IMAGE_00001" is highlighted, showing a date of "7/20/05" and a size of "73.5K". Other files listed include "PocketShot", "PShot000", "PShot001", "PShot002", and "PShot003".</p>

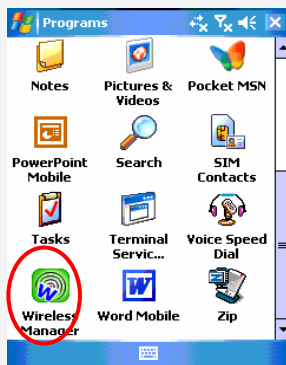
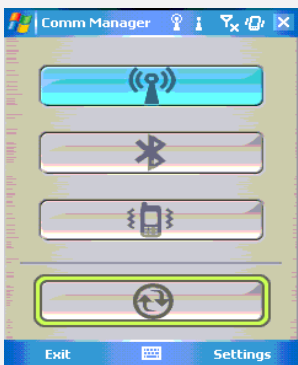
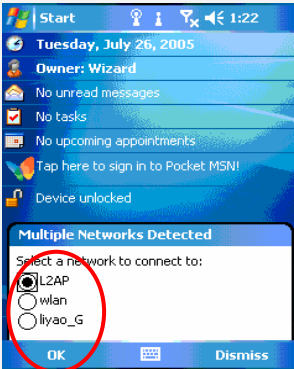

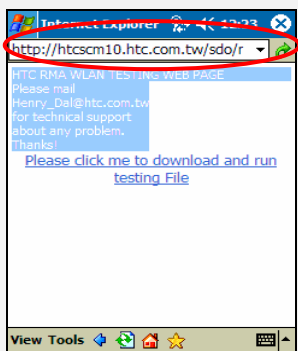
10.6 WLAN Function Test

<p>->Enable Wireless manager</p> <p>-> Turn on WLAN</p>	 <p>(Click Wireless manager icon)</p>  <p>(Turn on WLAN)</p>
<p>->Choice AP device when multiple networks detected.</p> <p>->Check the symbol of connection and power performance indicate to ensure the wireless is turn on as well.</p>	 <p>(Choice AP device)</p>  <p>(Check WLAN performance)</p>
<p>->Tap Start->Internet Explorer.</p> <p>->Enter web address: :http://htcscm10.htc.com.tw/SDO/WLAN.ASP</p>	 <p>(Select Internet Explorer)</p>  <p>(Enter web address)</p>

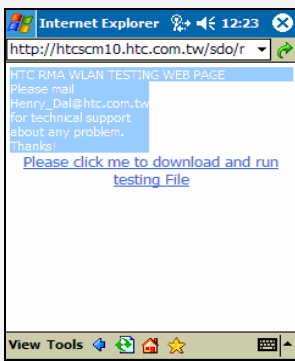
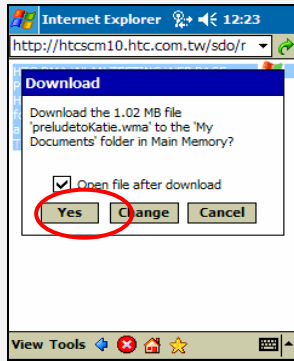

<p>->Login HTC WLAN testing web page.</p> <p>->Please tap the indication at center of screen to start download file.</p> <p>->Tap "Yes" and start to download mp3 file.</p>	<div style="display: flex; justify-content: space-around;"> <div style="text-align: center;">  <p>(HTC WLAN testing web)</p> </div> <div style="text-align: center;">  <p>(Download file for 1Mbytes)</p> </div> </div>
<p>->After download finished, please check the playing status in windows media to ensure the function is normal.</p>	<div style="display: flex; justify-content: space-around;"> <div style="text-align: center;">  <p>(File download)</p> </div> <div style="text-align: center;">  <p>(Play in Windows media)</p> </div> </div>



11. Firmware of OS/ Radio/Application upgrade

11.1 RUU (Rom Upgrade Utility)

OS/GSM/AP upgrade is performed via RUU download from RMAIII or customer web. Service center is required to make the first master unit via RUU (Rom Upgrade Utility). RUU package is able to download from HTC RMAIII

Website <http://htcscm10.htc.com.tw/rmaiii/> or customer website with some easy step. Make sure your master unit is fully charged before starting download.

Based on encoded mechanism for locking of CID and language, service center is able to purchase some **128 MB** encoded mini-SD card from HTC for ROM image download purpose.

The following steps will lead you how to build your master unit via :

1. RUU mechanism.
2. New sample unit

Also the procedure is able to create mini-SD card for re-flash purpose, then for each repair unit, you only need to do re-flash via mini-SD card. You could decide how many mini-SD cards you need for this purpose depend on your needed. You can send PO to HTC for purchasing the encoded mini-SD card, material description is as follows

“Prodigy re-flash card, 128 MB”

Caution: It is suggested to re-flash unit under boot-loader mode, once re-flash process is not successful, please enter boot-loader mode and re-flash again.

- a. Execute RUU, here is an example, actually file name and process depend on released RUU version.





b. Following display will show on screen:

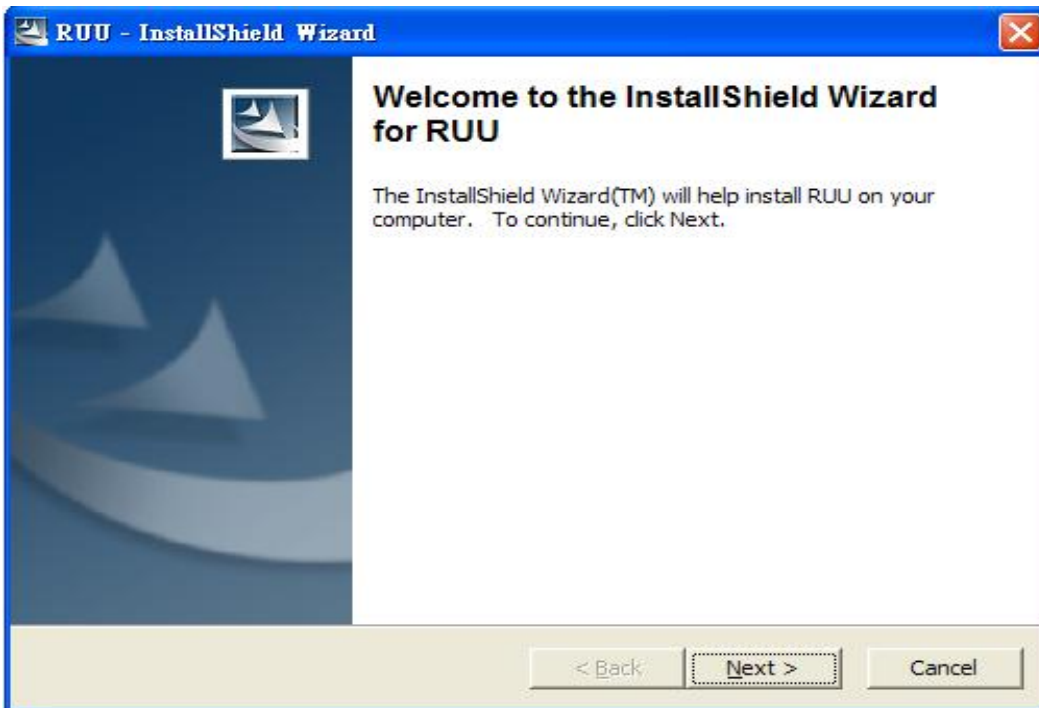

c. Type Next

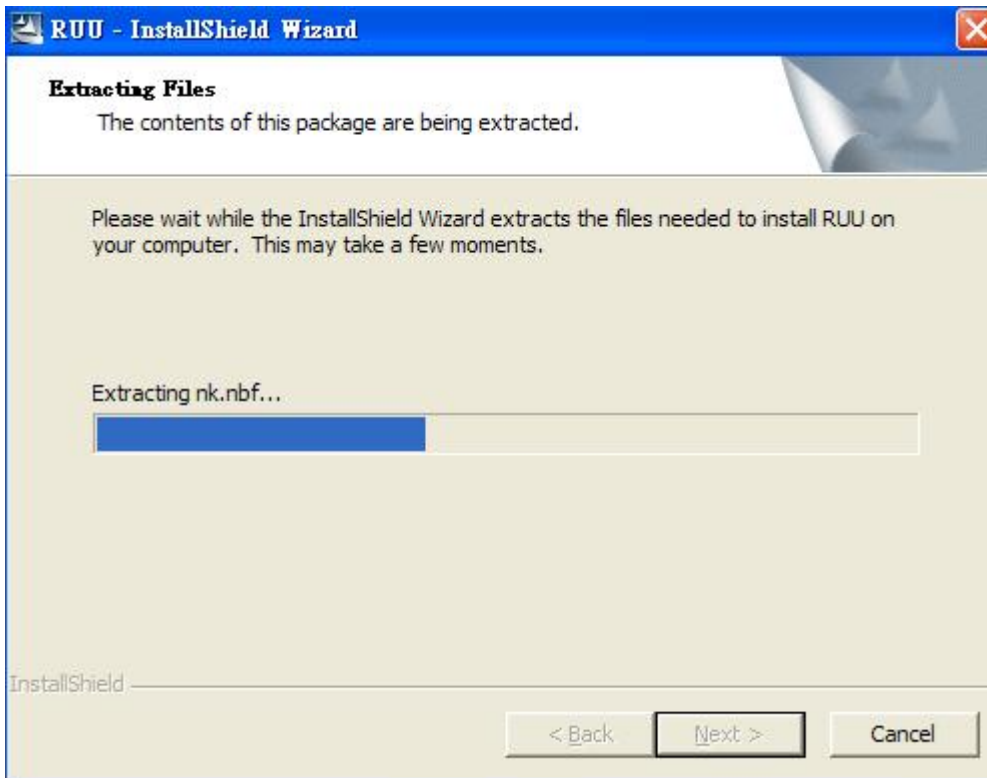



d. The screen will show on display, click NEXT

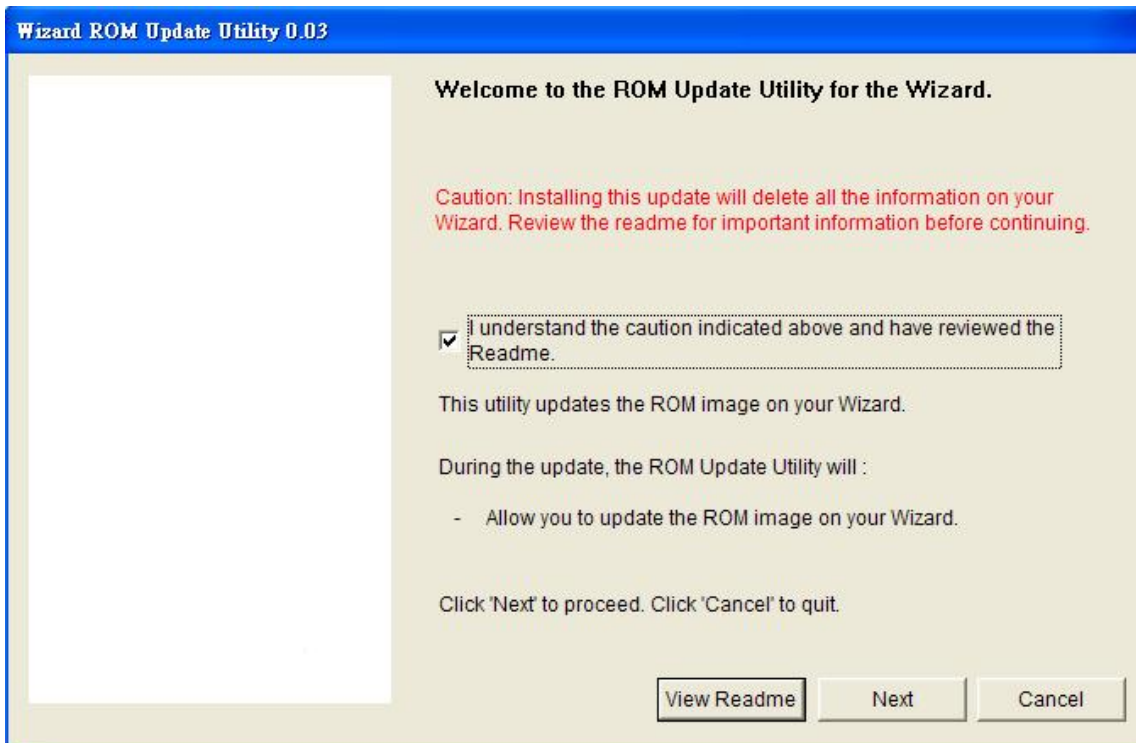

e. Follow the instruction on PC and make sure Active Sync connection is established before go to **NEXT**

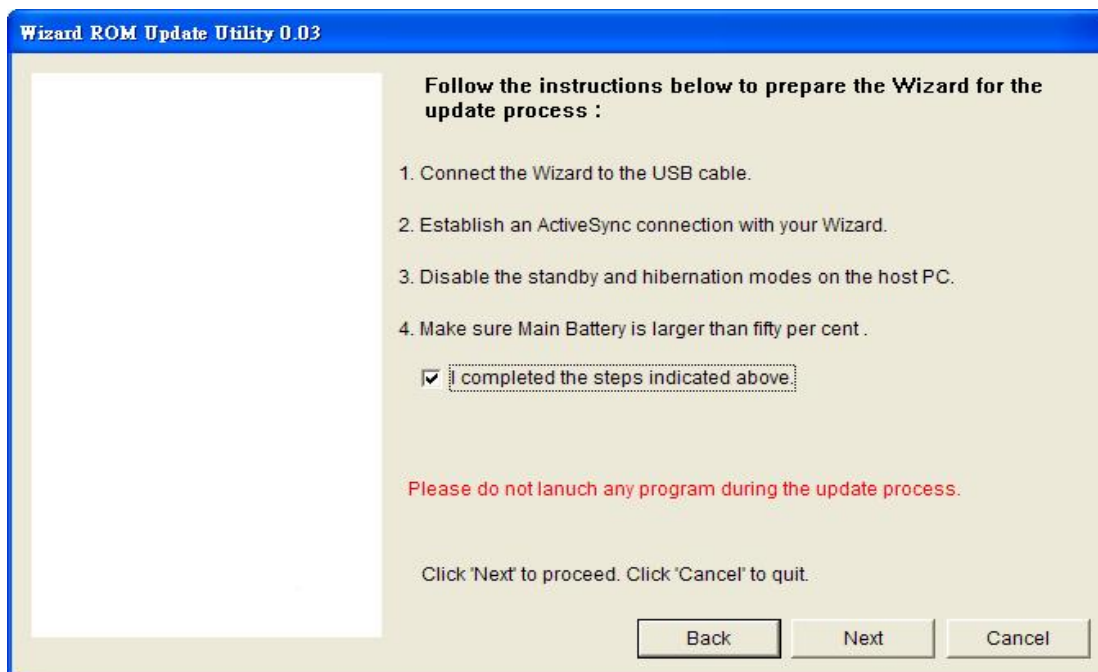



f. Click Update

Wizard ROM Update Utility 0.03

Current information about your Wizard:

Model ID :

Image Version :

Language :

Select from below:

Update the current ROM version.

Click 'Cancel' to quit.

g. Click NEXT

Wizard ROM Update Utility 0.03

Verify that you want to update the ROM version:

From :

Model ID :

Image Version :

Language :

To :

Model ID : Wizard

Image Version : 0.28.0.5

Language : WWE

Click 'Next' to proceed. Click 'Cancel' to quit.



h. Click NEXT and wait until process completed.

Wizard ROM Update Utility 0.03

You are now ready to update your ROM image. This operation takes approximately 10 minutes.

During the update process, the following things occur.

- The Wizard is prepared for the update process.
- The progress bar is displayed on the host PC and on the Wizard.
- The completion screen is displayed on the host PC.

Click 'Next' to proceed. Click 'Cancel' to quit.

Back Next Cancel

i. Start to re-flash unit

92%

Updating the ROM image on your Wizard...

Please do not remove the USB connection from the Wizard or launch any program during the update process.

Remember, the operation will take about 10 minutes.



j. Once completed, Display will show as below in PC, and unit will be auto re-boot



Caution: if the screen in computer shows as above, the handset is still stand on re-flash screen (100%), please wait a moment without disconnect USB cable.

Caution: if the screen is frozen after re-flash, Please try to execute Hard-reset.



11.2 Upload ROM image from master unit to HTC encoded mini-SD card

System Requirement:

- Windows 2000 above
- USB Cable or Cradle
- ActiveSync. Version 4.0 above
- MTTY.exe
- Master Unit with most updated Rom Code
- 128 MB encoded mini-SD card.

Caution: The unit must have at least 70% of battery capacity before starting the re-flash process.
Charge the battery in advance if necessary.

Note: For the master unit, you could prepare it on these following ways:

- Take one from Swap unit with most update Rom Code.
- Build one first by connecting to HTC website <http://htcscm10.htc.com.tw/rmaiii/>
- Customer website for OS Upgrade/ Download via RUU.

(You Only need to do this ONCE there are New RUU released)

- a. Uncheck USB and COM port in Connection Settings in ActiveSync if you have installed the ActiveSync 4.0 above in your PC and make sure the USB port is available.

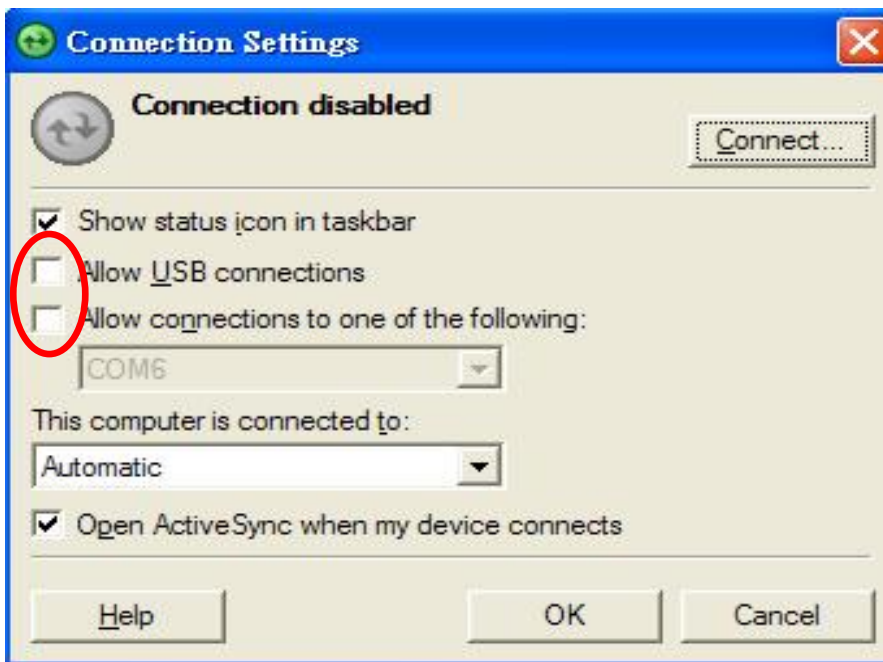



- b. Set the Unit into Boot-loader Mode (While **Press & Hold** Capture button and Reset the units), wait for the screen show on display



- c. **Connect USB cable to unit and PC**, Execute MTTY.exe (V1.42 above) and set to USB Port, Here is an example, actually display depend on MTTY.exe version.

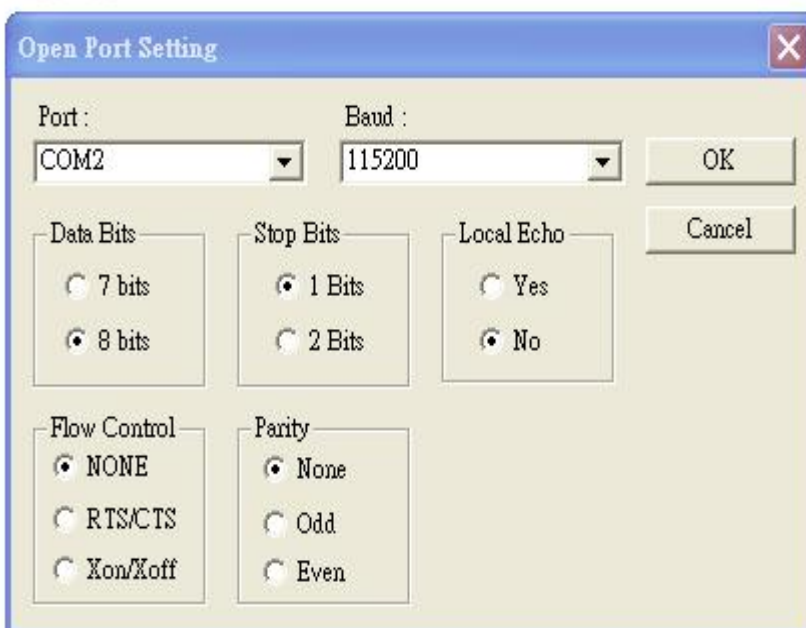



d. Insert HTC encoded 128 MB mini-SD card into mini-SD slot



e. On the PC side, Select OK and press ENTER. Following display will show on PC

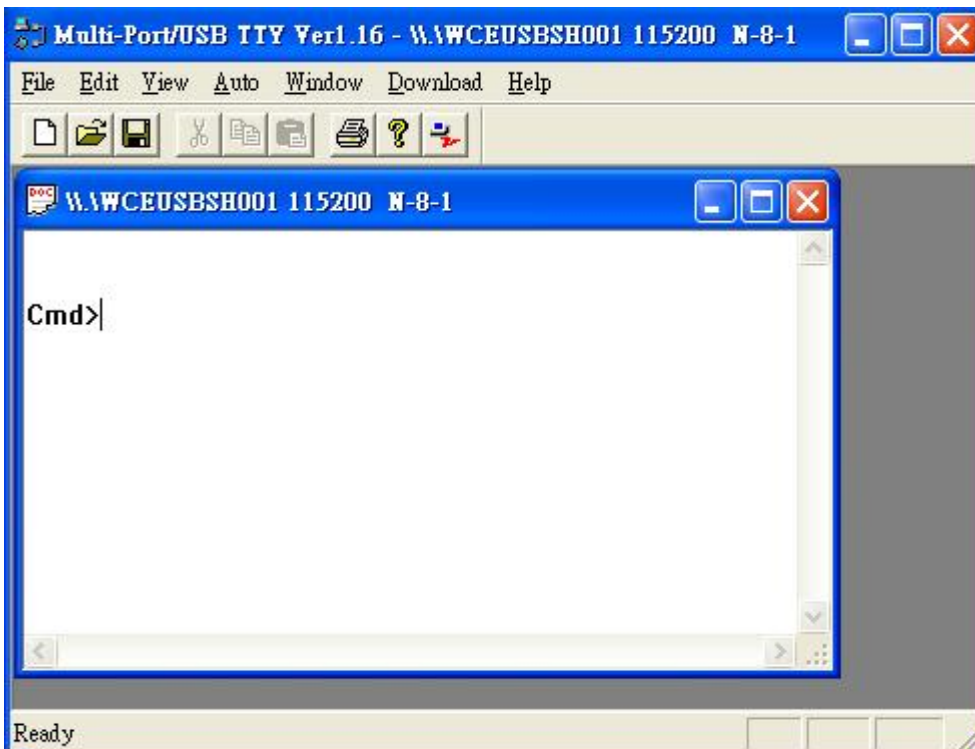



f. The prompt "Cmd>" will appear, then upload ROM Image , Type:

Cmd>r2sd all

(it means to upload ROM image code to encoded mini-SD card by typing r2sd command, note there is a blank space between r2sd , all), then Press **ENTER**

The following display will be shown on PC screen

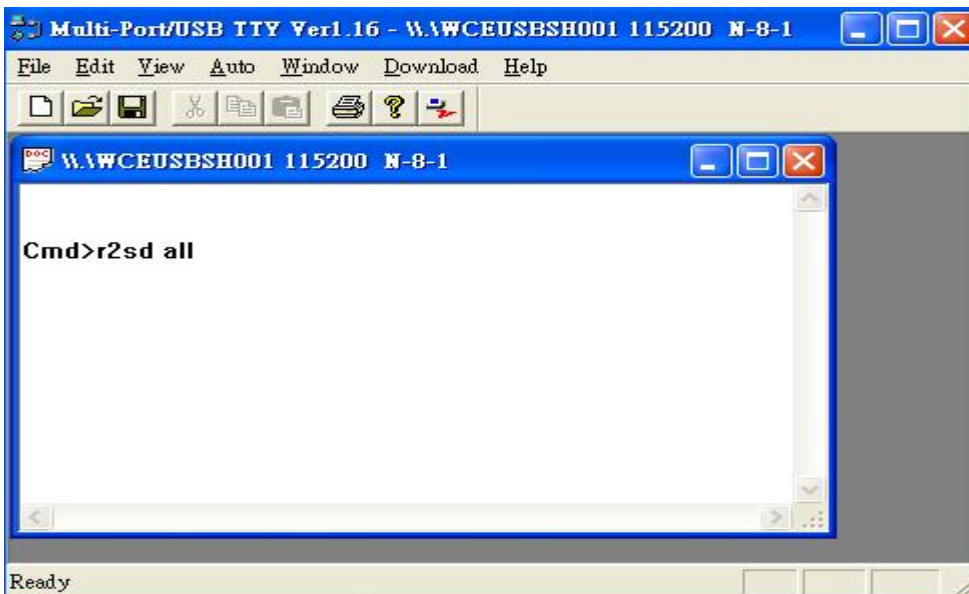

g. The process begins and waiting for some minutes, if process is done the screen will show on PC.

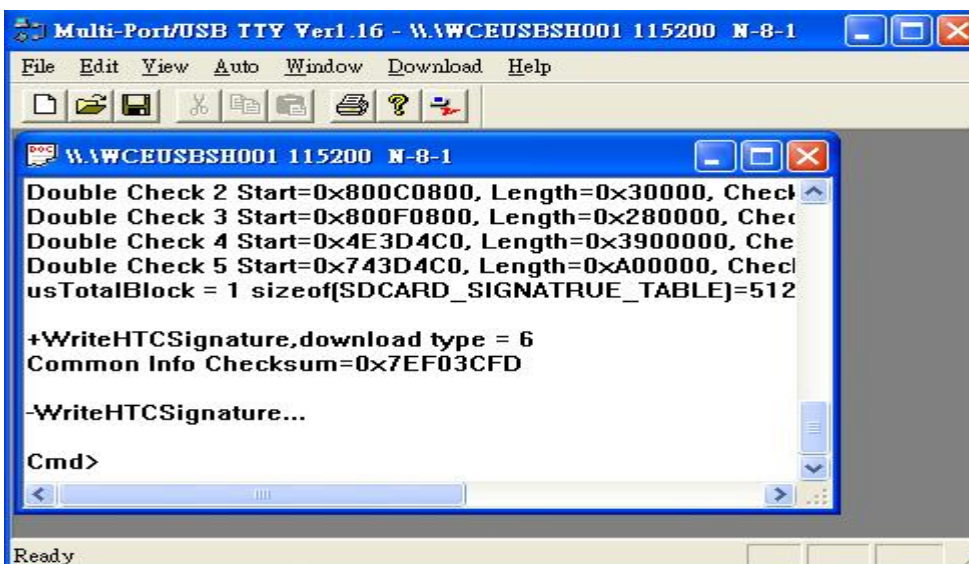

CAUTION! DO NOT REMOVE THE USB CABLE FROM THE PC OR PDA, FAIL TO DO SO MAY CAUSE DEVICE UNIT FAIL TO BOOT.



h. if process is done, The screen will show on unit.



Take out the mini-SD card from PDA phone and mark it according to the Language you build for.



11.3 Use Pre-loaded mini-SD card to Re-flash Unit

- a. Insert Pre-loaded mini-SD card to the unit. Please pay attention **not to format** the mini-SD card.
- b. Reset the unit and enter the boot-loader mode (by pressing **Capture button** simultaneously and **Reset** the unit), Display will show message as below....



- c. Follow the instruction on the unit by pressing Voice dial key (**Record button**) to start re-flash. Once process is done, the screen will be showing as below

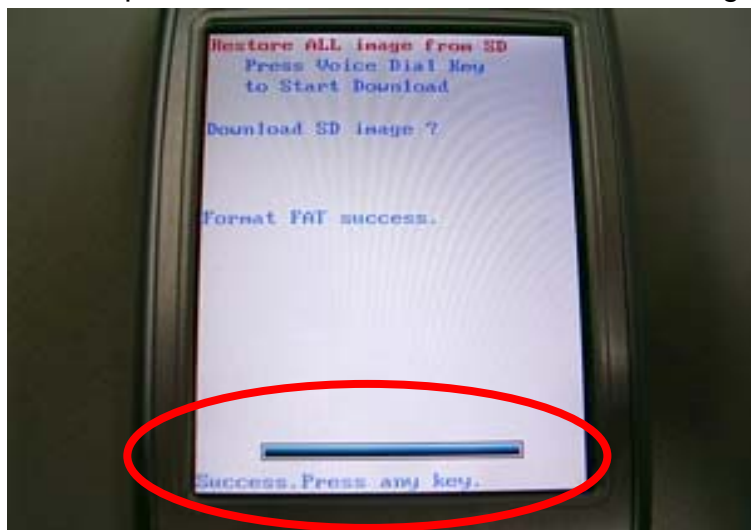

- d. Take out the mini-SD card and RESET the device (unit). Now the upgrade procedure is **done**.

Caution: Due to security issue, it is not allowed to re-flash different customer ID .



12. Troubleshooting & Repair

Before repairing, please try to duplicate if the symptom exist or Customer mishandling

1 – A · Main Unit Does Not Respond to Power Button

1 – B · Main Unit Does Not Respond to Battery Switch

1 – C · Charge light is red when plug in AC adapter

- (1) Make sure the Battery is installed properly to activate the battery pack.
- (2) Connect the AC Adapter, maybe the battery pack is exhaust.
- (3) Check the Battery cover is close properly.
- (4) Try with another battery pack.
- (5) Replace battery pack if necessary.
- (6) Try to enter boot loader mode, Perform Re-flash OS if successfully.
- (7) CMOS Camera is not assembled properly.
- (8) Check all connections including LCD FPC to Main Board. Try with another Main Board.
- (9) Fuse blown .
- (10) Customer abuse caused the power button fallen off
- (11) Both item 9 & 10 , MB replacement is necessary unless you are authorized to do board level repair.
- (12) If Charge light is red when plug in AC adapter, it means the main battery is not charge enough and can't power on,
You just need to continue charge unit the light become Amber.
- (13) Once the defective part has been identified, verify it again with the defective part whether the symptom could be duplicated.

2 – A · Touch Panel Does Not Respond to Screen Tap

- (1) Dismantle the unit, check the perimeter of Display between display Bezel and Touch Panel surface for unusual foreign objects. Clean it, reassemble the unit and check the panel's function again.
- (2) Check the connection of LCM FPC whether is properly connected.
- (3) Try with another LCM.
- (4) Try with another Rigid-Flex board.
- (5) Try with another Main Board.
- (6) Replace LCM if necessary
- (7) Replace Main Board if necessary.
- (8) Once the defective part has been identified, verify it again with the defective part whether the symptom could be duplicated.



2– B · Buttons Do Not Respond

- (1) Dismantle the unit, check the status of switches on the Main Board and the plastic parts of button of the Button not responding.
- (2) Try with another Main Board, rigid-Flex or keypad.
- (3) Replace Main Board, rigid-Flex or keypad if necessary.
- (4) Once the defective part has been identified, verify it again with the defective part whether the symptom could be duplicated.
- (5) Hard Reset The unit.

3– A · Unusual Vertical / Horizontal lines or partial display

- (1) Check the connection of LCM FPC whether is properly connected.
- (2) Try with another LCM.
- (3) Try with another Rigid-Flex board
- (4) Try with another Main Board.
- (5) Replace LCM if necessary
- (6) Replace rigid-Flex board if necessary
- (7) Replace Main Board if necessary.
- (8) Once the defective part has been identified, verify it again with the defective part whether the symptom could be duplicated.

3– B · Back Light Does Not Turn ON/OFF

- (1) Check the connection of FPC whether is properly connected.
- (2) Try with another LCM.
- (3) Try with another Rigid-Flex board
- (4) Try with another Main Board.
- (5) Replace LCM if necessary
- (6) Replace rigid-Flex board if necessary
- (7) Replace Main Board if necessary.
- (8) Once the defective part has been identified, verify it again with the defective part whether the symptom could be duplicated.



4 – A · Mini-SD Card cannot be used

- (1) Check whether mini-SD Card is fully inserted to the slot until you hear a click.
- (2) Try with another mini-SD card and Check whether it is Write Protected.
- (3) Try with another Main Board.
- (4) Replace Main Board if necessary.
- (5) Once the defective part has been identified, verify it again with the defective part whether the symptom could be duplicated.

5 – A · PC Connection (USB) not possible

- (1) Check whether “Connection Settings” in the MS ActiveSync is properly set.
- (2) Check whether it connects with other cables or cradle, customer’s cable might be damaged.
- (3) Check the external appearance of the connector on the unit whether it is physically damaged.
- (4) Replace Main Board if necessary.
- (5) Once the defective part has been identified, verify it again with the defective part whether the symptom could be duplicated.

5 – B · Wireless Connection (GSM / GPRS / BT / WLAN) not possible

- (1) Make sure the user has been contacting the Carrier for SIM Card validation and activation.
- (2) Make sure the Wireless Connection Settings has been properly set.
- (3) Make sure the SIM Card is properly inserted to the SIM compartment. Make a life call or test it with the RF Test Station (Antenna Test).
- (4) Dismantle the Main Unit and check whether the Antenna cover is properly installed.
- (5) Try with another Antenna cover.
- (6) Try with another Main Board if necessary.
- (7) Once the defective part has been identified, verify it again with the defective part whether the symptom could be duplicated.



5– C · IrDA Connection not possible

- (1) Make sure the IrDA port settings on the Notebook or PC are properly set.
- (2) Make sure the IrDA function is properly activated on the Pocket PC and on the other device.
- (3) Make sure there's no obstruction between the two devices in connection and within the distance.
- (4) Check the IrDA window whether it is broken or cracked. Replace Front Bezel if necessary.
- (5) Replace Main Board if necessary.
- (6) Once the defective part has been identified, verify it again with the defective part whether the symptom could be duplicated.

6– A · Main Battery does not start

- (1) Make sure the Battery cover is closed properly.
- (2) Connect to the AC Adapter and see if it takes charge. Also check AC Adapter condition.
- (3) Check whether AC Adapter is functioning properly.
- (4) Check whether the condition of Battery Charging status is correct.
- (5) Dismantle the unit and check the appearance of Battery cover.
- (6) Try with another Main Board or Replace Main Board if necessary.
- (7) Once the defective part has been identified, verify it again with the defective part whether the symptom could be duplicated.

6– B · Battery discharges quickly even after fully charged

- (1) Make sure the Battery Pack takes fully charge with AC Adapter.
- (2) Check whether the condition of Battery Charging status is correct.
- (3) Dismantle the unit and check the appearance of Battery cover.
- (4) Try with another Battery or Replace Battery if necessary
- (5) Try with another Main Board or Replace Main Board if necessary.
- (6) Once the defective part has been identified, verify it again with the defective part whether the symptom could be duplicated.



7–C · Main Battery does not recharge

- (1) Make sure the Battery takes fully charge with AC Adapter.
- (2) Check whether the condition of Battery Charging status is correct. Charge should be done in no more than 3 hours.
- (3) Dismantle the unit and check the appearance of Battery cover.
- (4) Try with another Battery or Replace Battery if necessary
- (5) Try with another Main Board or Replace Main Board if necessary.
- (6) Once the defective part has been identified, verify it again with the defective part whether the symptom could be duplicated.

8–A · No Sound from Speaker or Distorted sound

- (1) Check “Sound & Notifications” Settings in the unit for Sound Enabling.
- (2) Make sure it’s not MUTED.
- (3) Dismantle and Check whether the Speaker is properly installed (Orientation)
- (4) Make sure the connection point between MB and Speaker is free from contamination or dust.
- (5) Replace Speaker if necessary.
- (6) Replace Main Board if necessary.
- (7) Once the defective part has been identified, verify it again with the defective part whether the symptom could be duplicated.
- (8) Replace Camera if camera function was defect at the same time.

9–A · No Recorded Sound or Distorted sound

- (1) Check “Sound & Notifications” Settings in the unit for Sound Enabling.
- (2) Make sure it’s not MUTED.
- (3) Dismantle and Check whether the Microphone is properly installed (check or missing rubber)
- (4) Replace Microphone if necessary.
- (5) Replace Main Board if necessary.
- (6) Once the defective part has been identified, verify it again with the defective part whether the symptom could be duplicated.

10–A · Bezel, Housing Cosmetic damage

- (1) Unless it is for Refurbishment, all Bezel, housing replacement due to cosmetic damage shall treat as out of warranty



13. Spare part list

13.1 Unit spare part list

Item	HTCP/N	Description	For LCD vendor	SKU P/N	Using Q'ty
			Toppoly / Samsung	99HBHXXX-XX	Q'ty
1	35H00062-00M	BATTERY_LI-ION,1200mAh,3.7V,ICP063450GJ,MAXELL	Toppoly / Samsung	0	1
2	36H00180-00M	Vibrator,Cylinder type,A4A-05-WTB-3,C.I.Kasei,dia.4mm shell,dia.5mm	Toppoly / Samsung	0	1
3	36H00288-00M	Speaker,DSH-911,MERRY,16*10*4.4mm	Toppoly / Samsung	0	2
4	36H00328-00M	Receiver,DTR830-001,MERRY,70/-30degC	Toppoly / Samsung	0	1
5	36H00341-00M	Antenna Pre-Assy,AMPHENOL,GAN40023,PRODIGY	Toppoly / Samsung	0	1
6	54H00129-00M	Module Assy,Flash light,LTM-0447W,LITEON,12*7*0.5mm	Toppoly / Samsung	0	1
7	54H00134-00M	Camera Module Assy,LITEON,LT9653FCL-HT-113r	Toppoly / Samsung	0	1
8-1	60H00032-00	LCD Module,,Samsung,Magician, 1st source	Samsung	0	1
8-2	60H00037-00M	LCD Module,Toppoly,Magician, 2nd source	Toppoly	0	1
9	72H01000-00M	Holder,Strap holder, Keyboard, PRODIGY	Toppoly / Samsung	0	1
10	72H01016-00M	Screw,FPHM1.4-0.3X1.6TP-PSH(3.25.0.25)Ni	Toppoly / Samsung	0	8
11	72H01048-00M	Gasket,Conductive Cloth,Shielding-Mainboard,Wizard	Toppoly / Samsung	0	1
12	72H01049-00M	Gasket,Conductive Sponge,EDGE,Wizard	Toppoly / Samsung	0	1
13	72H01052-00M	Screw,HAMA NAKA SHOUKIN,for cover C-D,Ni/BL,	Toppoly / Samsung	0	4
14	72H01065-00M	Gasket,conductive fabric, PRODIGY	Toppoly / Samsung	0	2
15	72H01109-00M	Screw,FPH,T5, 3Dx0.5T,M1.6-0.35x3.5,Ni/BLK+Ny	Toppoly / Samsung	0	8
16	72H01129-00M	Screw,PH,FD,T1.4*2.9,Nickel,Black,AISI 1018	Toppoly / Samsung	0	4
17	72H01135-00M	EMI Gasket,conductive fabric tape,R-F board,PRODIGY	Toppoly / Samsung	0	5
18	73H20033-09M	FPC Pre-Assy,CAREER,QWERTYKEY FPC 2Layers	Toppoly / Samsung	0	1
19	74H00496-00M	Keypad Pre-Assy,Navi-key Assy	Toppoly / Samsung	0	1
20	74H00497-00M	Keypad Pre-Assy,AP-key Assy	Toppoly / Samsung	0	1
21-1	74H00498-0XM	Housing Pre-Assy,Display, 1st source	Toppoly / Samsung	0	1
21-2	74H00498-5XM	Housing Pre-Assy,Display,NYPRO, 2nd source	Toppoly / Samsung	0	1
22-1	74H00499-0XM	Bezel Pre-Assy,Keyboard, 1st source	Toppoly / Samsung	0	1
22-2	74H00499-5XM	Bezel Pre-Assy,Keyboard,NYPRO, 2nd source	Toppoly / Samsung	0	1
23	74H00501-XX	Housing Pre-Assy,Keyboard, PRODIGY	Toppoly / Samsung	0	1
24	74H00503-XX	Cover Pre-Assy,Batter cover Assy, PRODIGY	Toppoly / Samsung	0	1
25	74H00504-00M	Stylus Pre-Assy,Stylus Assy, PRODIGY	Toppoly / Samsung	0	1
26	74H00542-XXM	Keypad Pre-Assy,Qwerty key,PRODIGY	Toppoly / Samsung	0	1
27	74H00596-XX	Bezel Pre-Assy,Display,w/o navi key & AP key	Toppoly / Samsung	0	1
28	76H01030-00M	Rubber,microphone,wizard	Toppoly / Samsung	0	1
29	76H01036-00M	Tape,anti-short,Rigid-Flex board,Kapton tape film,Wizard	Toppoly / Samsung	0	2
30	76H01061-00M	Mylar,mainpcb,Wizard	Toppoly / Samsung	0	1
31	76H01138-00M	Tape,Kapton tape film,Fixing,Prodigy	Toppoly / Samsung	0	1
32	77H00116-01M	LCD Film for EULA,PDA,85*55mm,E/F/G//T/A,Himalayas	Toppoly / Samsung	0	1
33	77H00184-00	Security Label,Typhoon	Toppoly / Samsung	0	1
34	77H00193-00M	Liquid Damage Indicator, ONTARIO	Toppoly / Samsung	0	1
35	77H00202-00M	Windows Mobile Branding Jewel Label,Colorado	Toppoly / Samsung	0	1
36	77H00284-XX	Regulation Label,CHENG MAY,polyester,WIZA200,WEEE,A-Tick	Toppoly / Samsung	0	1
37-1	80H00418-00	Rigid-Flex Board ASSY,Samsung, Prodigy, 1st source, 51H10045-00M + 72H01135-00M	Samsung	0	1
37-2	80H00418-01	Rigid-Flex Board ASSY,Toppoly, Prodigy, 2nd source, 51H10045-01M + 72H01135-00M	Toppoly	0	1
38	99HBH	FRU Unit w/o battery		99HBHXXX-01	1
39	99HBH	FRU Mainboard (SKU M/B 51H00296-00M)		99HBHXXX-02	1



Picture of SPL(Please check customer code before taking this part no.)

35H00062-00M		36H00180-00M		36H00288-00M	
BATTERY		Vibrator		Speaker	
Q'ty: 1		Q'ty: 1		Q'ty: 2	
36H00328-00M		36H00341-XX		54H00129-00M	
Receiver		Antenna Pre-Assy		Module Assy,Flash light	
Q'ty: 1		Q'ty: 1		Q'ty: 1	
54H00134-00M		60H		72H01000-XX	
Camera Module		LCM		Holder,Strap holder, Keyboard	
Q'ty: 1		Q'ty: 1		Q'ty: 1	
72H01016-00M		72H01048-00M		72H01049-00M	
Screw,FPHM1.4-0.3X1.6TP-		Gasket,Conductive Cloth,Shielding-		Gasket,Conductive Sponge,EDGE,Wizard	
Q'ty: 8		Q'ty:1		Q'ty: 1	
72H01052-00M		72H01065-00M		72H01109-00M	
Screw,HAMA NAKA SHOUKIN,for cover C-		Gasket,conductive fabric,PRODIGY		Screw,FPH,T5,3Dx0.5T,M1.6-	
Q'ty:4		Q'ty:2		Q'ty: 8	
72H01129-00M		72H01135-00M		73H20033-09M	
Screw,PH,FD,T1.4*2.9,Nickel,Black,AISI 1018		EMI Gasket,conductive fabric tape,R-F		FPC Pre-Assy,CAREER,QWERT	
Q'ty: 4		Q'ty: 5		Q'ty: 1	
74H00496-00M		74H00497-00M		74H00498-XX	
Keypad,Navi-key		Keypad,Navi-key		Housing Pre-Assy,Display	
Q'ty: 1		Q'ty: 1		Q'ty: 1	
74H00499-XX		74H00501-XX		74H00503-XX	
Bezel Pre-Assy,Keyboard		Housing Pre-Assy,Keyboard		Cover Pre-Assy,Batter cover Assy, PRODIGY	
Q'ty: 1		Q'ty: 1		Q'ty: 1	
74H00504-00M		74H00542-XX		74H00596-XX	
Stylus Pre-Assy,Stylus Assy, PRODIGY		Keypad Pre-Assy,Qwerty		Bezel Pre-Assy,Display	
Q'ty: 1		Q'ty: 1		Q'ty: 1	
76H01030-00M		76H01036-00M		76H01061-00M	
Rubber,microphone,wizard		Tape,anti-short,Rigid-Flex board,Kapton tape		Mylar,mainpcb,Wizard	
Q'ty: 1		Q'ty: 2		Q'ty: 1	
76H01138-00M		77H00116-XX		77H00184-00	
Tape,Kapton tape		LCD Film for EULA,PDA		Security Label,Typhoon	
Q'ty: 1		Q'ty: 1		Q'ty: 1	
77H00193-00M		77H00202-00M		77H00284-XX	
Liquid Damage Indicator, ONTARIO		Windows Mobile Branding		Regulation label	
Q'ty: 1		Q'ty: 1		Q'ty: 1	
80H00418-XX		99HBHXXX-01		99HBHXXX-02	
Rigid-Flex Board		FRU Unit w/o battery		main board	
Q'ty: 1		Q'ty: 1		Q'ty: 1	



14.2 Board Level Spare Part List

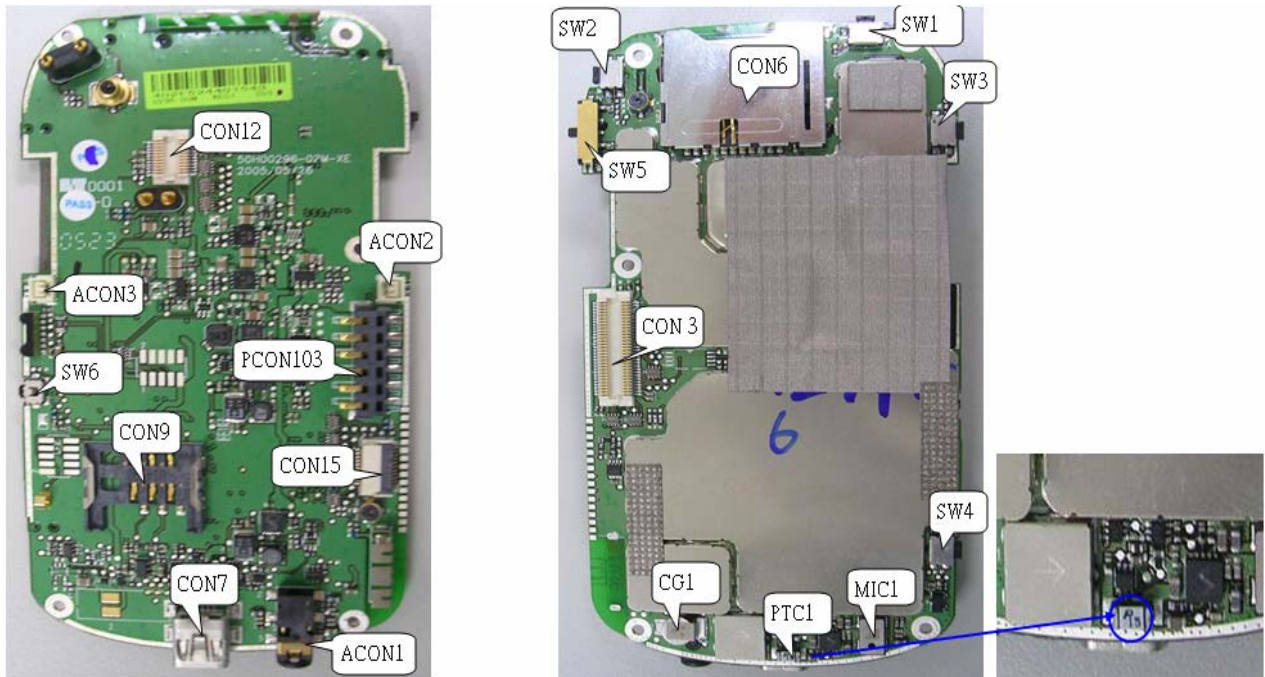

Item	HTC P/N	Description	Location	Using Qty	Remark
1	16H00012-00M	Gold Cap,0.07F,70ohm,3.3V,-25/+50%,XH414H I102EY,SEIKO	CG1	1	Gold cap (Backup battery)
2	36H00129-00M	SWITCH BUTTON,PTS-106,HCH,4.7*4.5*1.65,70/-20degC,BLUE ANGELS	SW1/ SW2/ SW3/ SW4	4	Power/ RF/ Record/ Capture
3	36H00160-00M	Slide Switch,HSS112,HCH	SW5	1	Volume control
4	36H00208-00M	MIC,SP0103NC3,EMKAY,Pb-FREE,100/-40degC,6.15*3.76*1.45 mm	MIC1	1	Microphone
5	36H00301-00M	Fuse,PTC,1.5A, 6V 0.04 ohm~0.12 ohm,0.08ohm,+/-50%,1206	PTC1	1	Fuse
6	36H00305-00M	Audio Jack,JP007-G4BA-2602XT,Misaki	ACON1	1	Audio Jack
7	36H00308-00M	Switch,Reset switch,SOH-213HNT,MITSUMI	SW6	1	Reset switch
8	75H00124-00M	Connector Device,BM02B-ASRS-TF LF SN,2pin,Pitch=1mm,JST	ACON2 ACON3	2	Speaker
9	75H00273-00M	Connector B to B,60P,0.5mmPitch,AXK5F60345,MATSUSHITA	CON3	1	Linking M/B and Rigid-Flex board
10	75H00379-00M	Connector I/O,Mini USB AB,5P,0.8Pitch,1A,30V,67803-8020,MOLEX	CON7	1	Mini USB
11	75H00395-00M	Connector SIM Card,50mohm,ICC-429,hamburg	CON9	1	SIM card connector
12	75H00397-00M	Connector B to B,22P,0.5pitch,AXK5F22345Y,MATSUSHITA	CON12	1	Camera connector
13	75H00432-00M	Connector SD Card,mini-SD,	CON6	1	mini SD card connector
14	75H00433-00M	Connector Device,SUYIN,250042MB006G305ZR,6pin,	PCON103	1	Battery connector
15	75H00449-00M	Connector FPC,30V,FH26-21S-0.3SHW 05,HIROSE	CON15	1	Qwerty keyboard connector



14. Appendix

A. Customer, Retailer Misjudgment

Before attempt repairing the unit, make sure the type of reported failure could be clearly reproduced; otherwise, check with the customer or distributor once again to identify the problem correctly. The following are failure symptoms that are typical by misjudgment

No.	Item	Possibility
1	No Power even the power button is pressed	Main Battery low power exhausted.
		While Back Light is turned OFF, the surrounding lighting will be reflected on the panel and in a dim location, it looks like the unit is turned OFF.
		According to the Power Management settings, the units will be switched OFF automatically.
2	Battery discharges quickly	The battery life depends on the devices being used in mini-SD Card Slot, and frequency of use of the Back light. These functions consume a lot of energy.
		Operating with front light ON, or using high energy consumption devices such as mini-SD Memory Card will drain out the battery pack faster.
3	Battery cannot be charged	Using AC adapter that is NOT supplied with the unit.
		Charging the battery while operating the unit with heavy loadings could cause the temperature inside the unit to build up which could cause the unit stop charging. At this moment, the LED indicator will flash Yellow to notify user that the charging has been stopped. Or the temperature is extremely low will also stop charging.
		Since the extreme high or low temperature will cause the battery to discharge quickly, it has been designed to cut battery charge below 0°C and above 35~40°C to protect the battery pack.
4	Cannot make communications via mobile phones through exclusive cable.	If the unit could pass the test with Loop back Interface card, the possibility of unit malfunction becomes low. Then the following items could be the reason of problem such as location, timing, signal strength, service provider's mixed up, or problem with the mobile itself. Or could be incompatibility issue.



5	Cannot use mini-SD Memory Card	Cards which are not being pre-formatted.
		Card not inserted completely, or bad contact between connector contacts.
6	Black or White dot on the screen.	For LCD panel's normal behavior, it is hard to find a panel without any bad pixel. Once the numbers of dots and the distance between them are within the specifications, it is allowed.
7	Touch Screen or Program Buttons are not reacting.	Could be wrong operation.
		Screen not properly aligned with the stylus calibration.
8	Front Light dim, cannot turn ON, or shuts OFF automatically.	Check the Front Light settings in Power Management settings
9	Cannot playback music, No sound or volume is low.	When Battery low, the music playback becomes difficult and the volume could become lower.
10	Cannot execute installed application programs	Could be an incompatible software
11	Operation is slow in response	Could be insufficient memory. Check amount of system memory.
12	Hang up	Software being used sometimes is not fully compatible with the system.
		Execute many application programs simultaneously
		Software that requires big amount of memory spaces or the system memory is low or the files being used is fragmented.
13	System Memory is enough, but is shows insufficient.	Software that requires big amount of memory spaces or the system memory is low or the files being used is fragmented.

***Note: Nevertheless, the above symptoms could be solved by a warm- reset or hard- reset, make sure the warm /hard reset has been executed and try to reproduce the symptom reported.**



B. How to perform Warm reset and Hard reset



Warm-reset : Reset the unit by pressing reset button.

Hard reset: Press and hold **Comm manager button + Record button**, then **Reset** the unit.
Press **Send Key** to turn back manufacture default setting



C. To remove main battery, it is requested that turn off the unit before removing main battery

D. It is suggested to re-flash unit under boot-loader mode, once re-flash process is not successful, please enter boot-loader mode and re-flash again.





E. If unit hang on 100% while using RUU re-flash, the screen in computer shows “Congratulation”, the handset is still stand on re-flash screen (100%) as below, please wait a moment without disconnect USB cable.

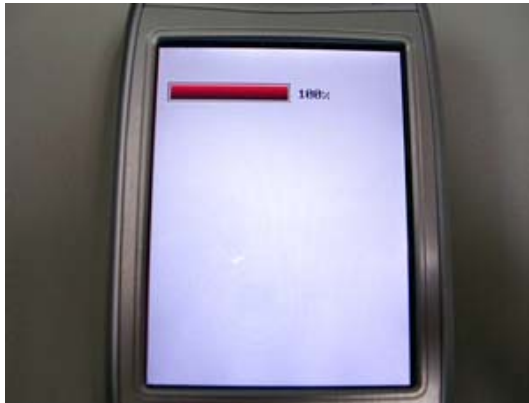

F. If the screen is frozen after re-flash done, Please try to execute Hard-reset.

G. If the unit can't turn on, Please try following step to check

1. Plug-in AC adapter, press power button
2. If it is still not working, Try to enter boot-loader
3. If it is still not working, try to execute hard-reset.
4. If it is still not working, replace another good battery to try again,
4. If it is still not working, try to check Fuse on the main board, make sure the component circuit can't be Open

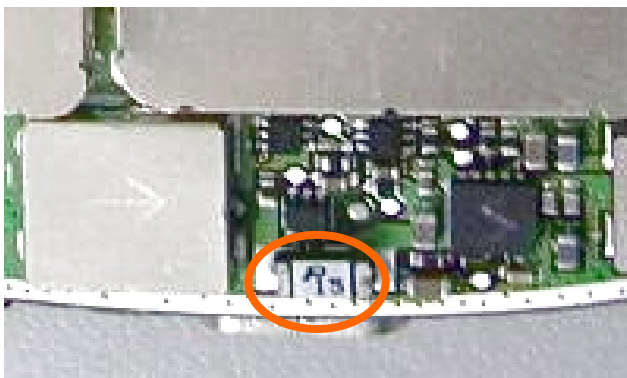







H. Please pay attention that following component with compatible request, Please refer to section 5.5 and 5.7 for detail.

1. LCM + rigid-flex board
2. LCM housing+ Keypad bezel



- I. There are two types diagnostic card, the purpose is to support different SPL version, One is supported unit's SPL version under V1.03, another one is supported unit's SPL version beyond V1.05 above. Both cards will provide to repair center, In order to identify card type vs. SPL version, We marked "SPL 1.05" on the label of diagnostic card. If your on hand diagnostic card can not enter diagnostic mode. Please check unit's SPL version, The match table is as follows.

Card's type	Marked	SPL version	Program Version
Support SPL V1.03 below			
Support SPL V1.05 above			
Differential description	If the card support SPL V1.05 above, marked " SPL 1.05 " on the label	In boot-loader mode, The SPL version is different	Program version is no different



→ ASP site code and its region

→ Consigned material numbering code