

▷ out

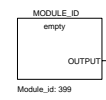

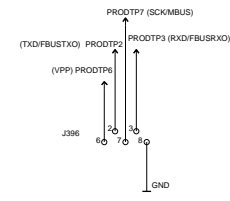

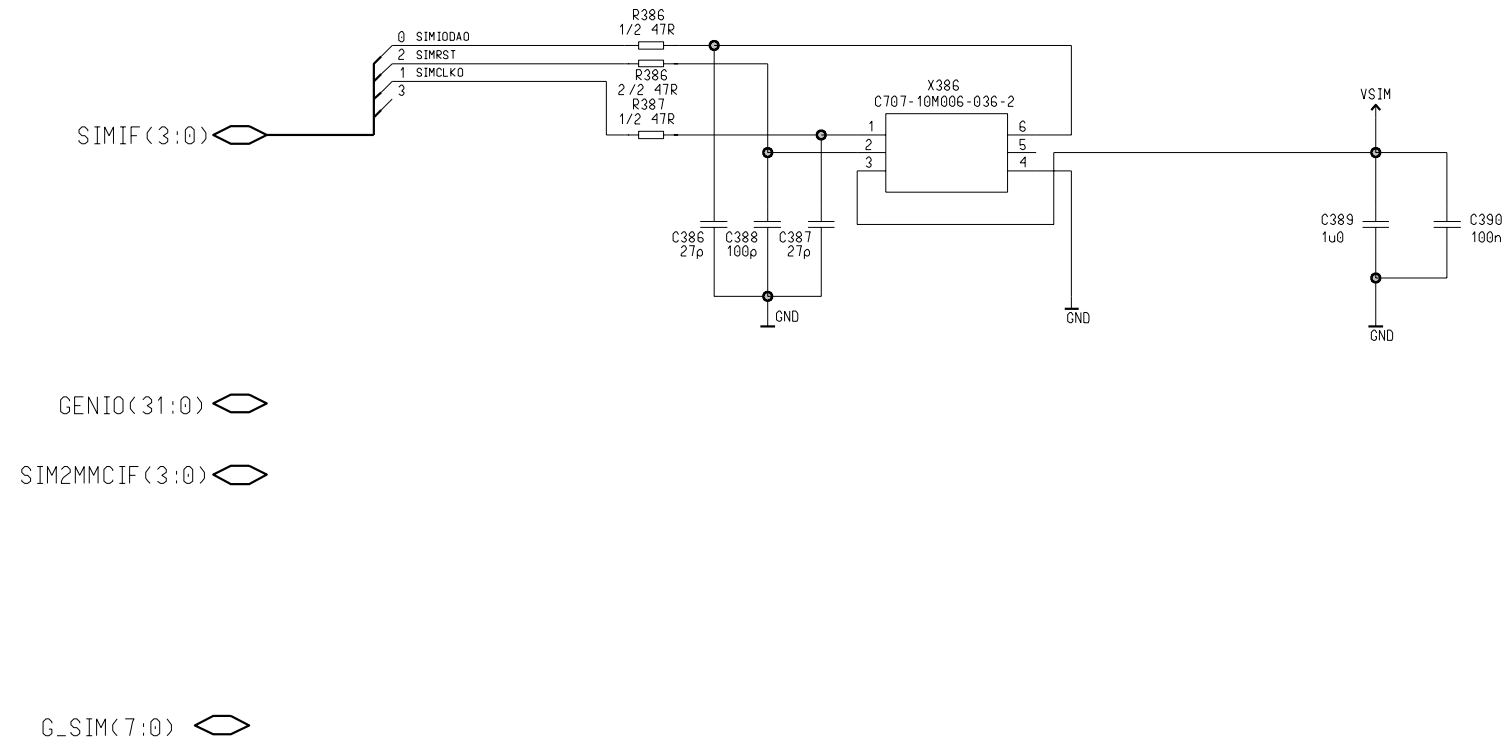

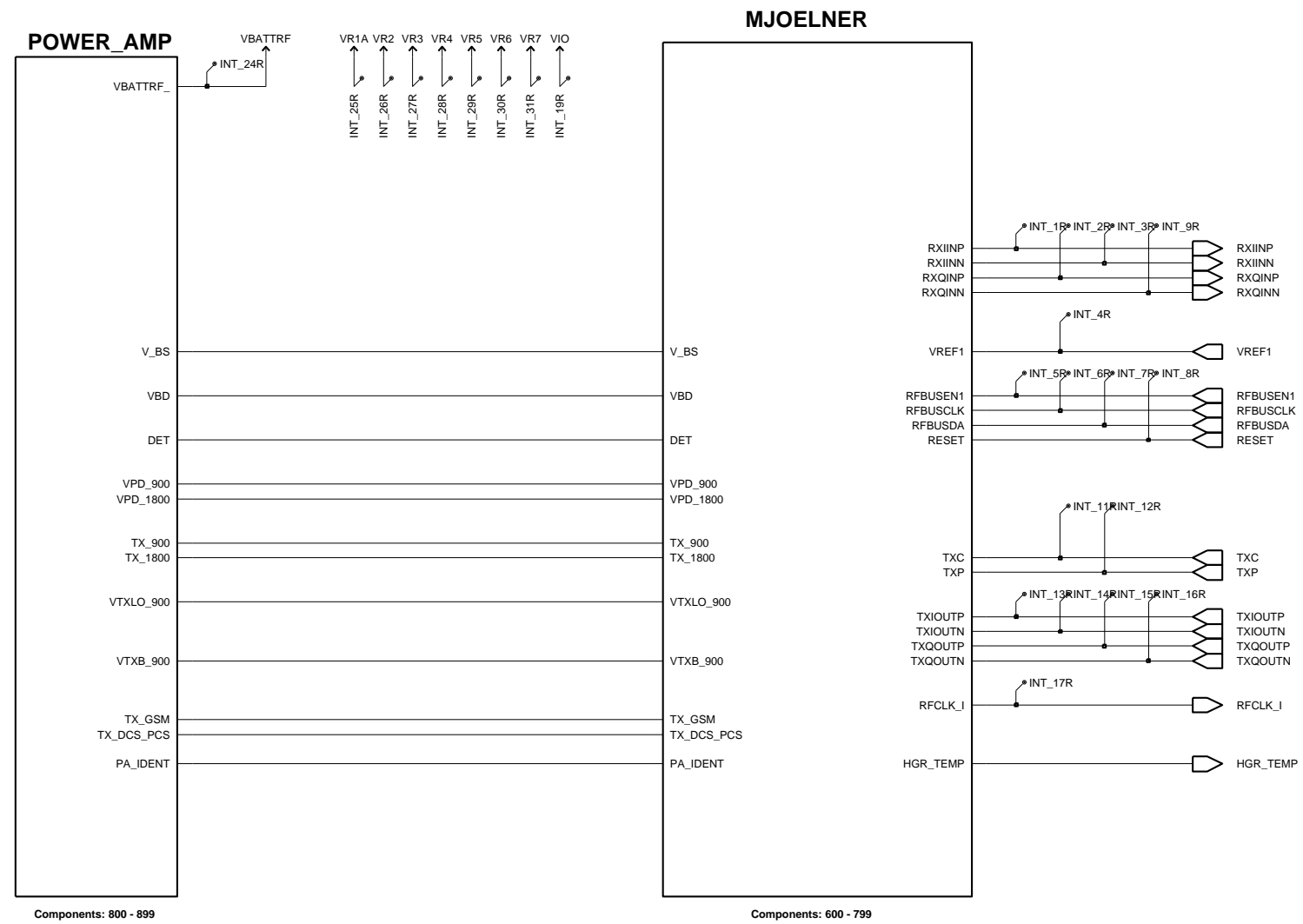
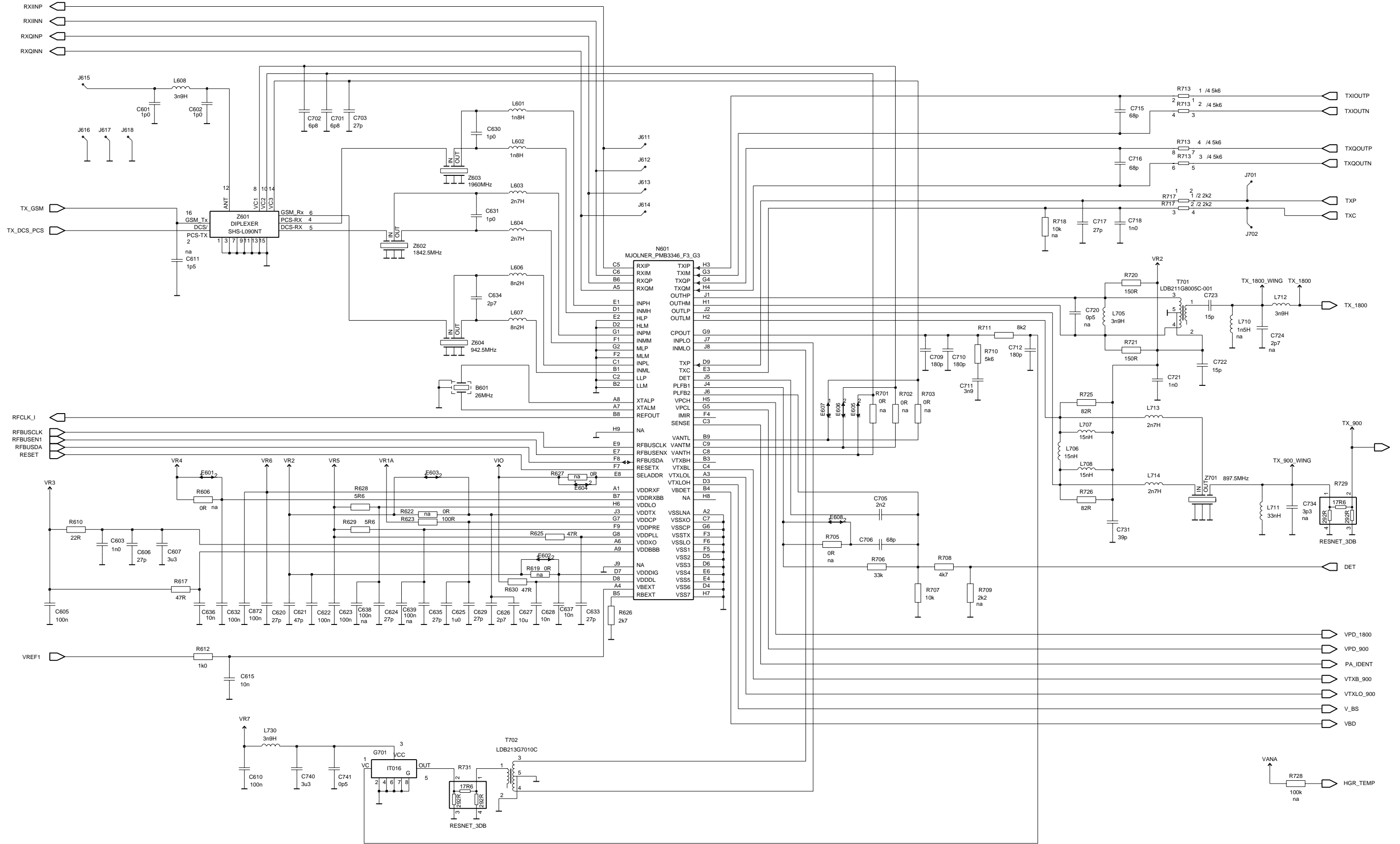

na = not assembled

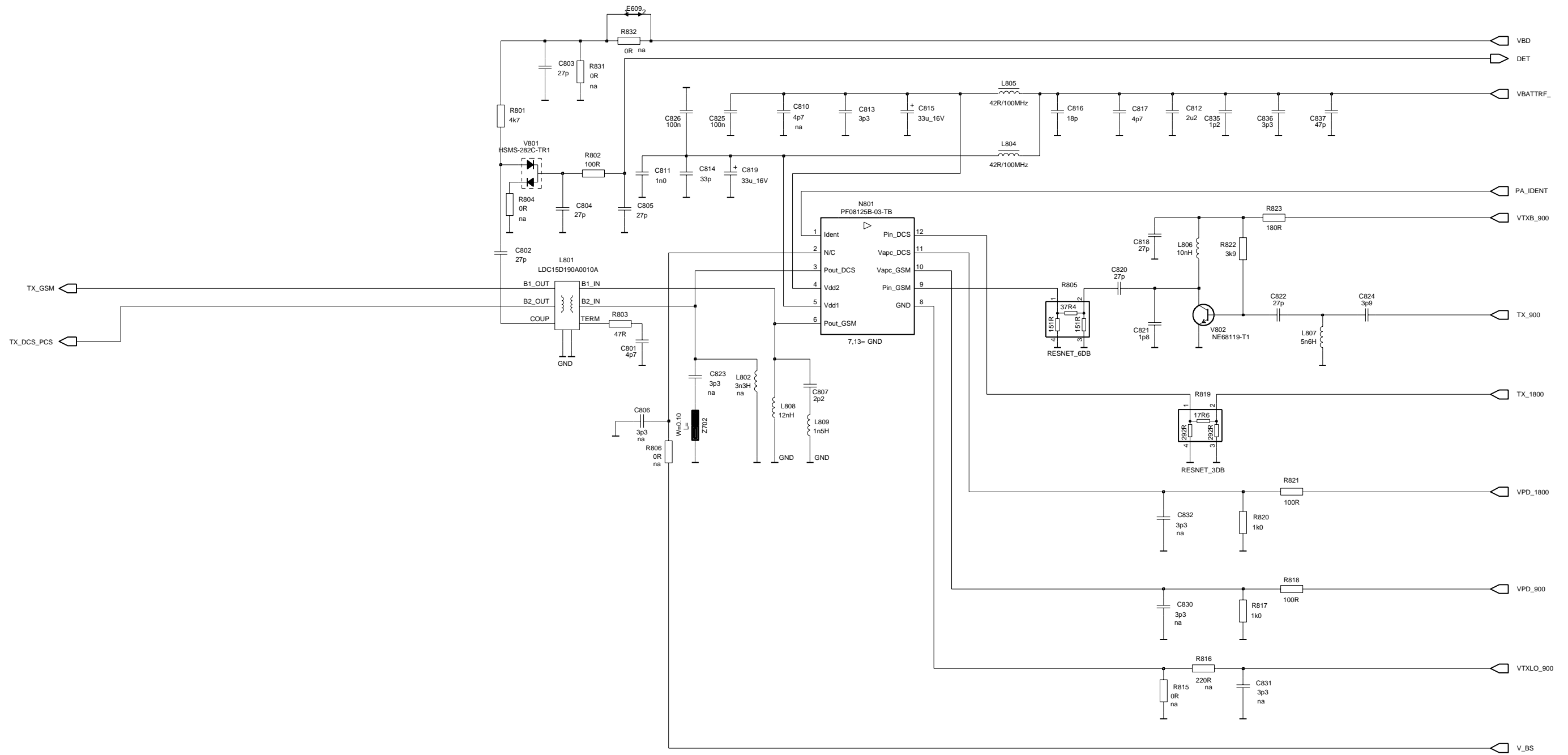

na = not assembled

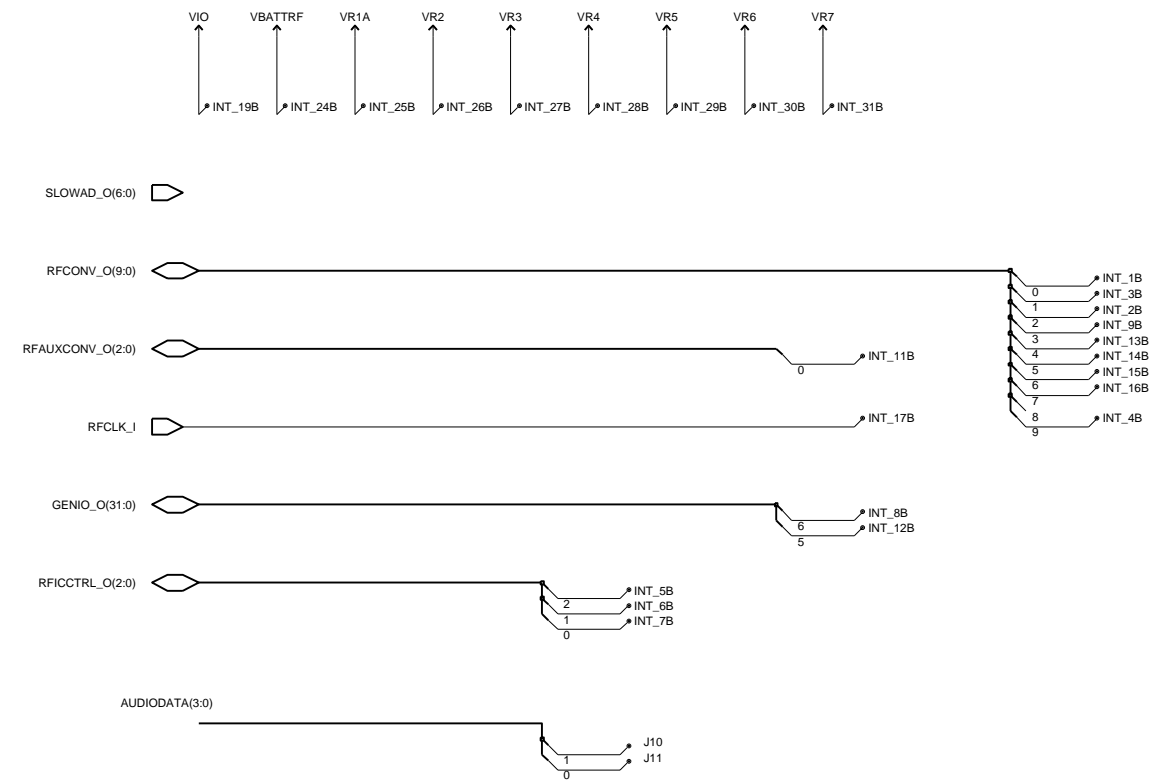

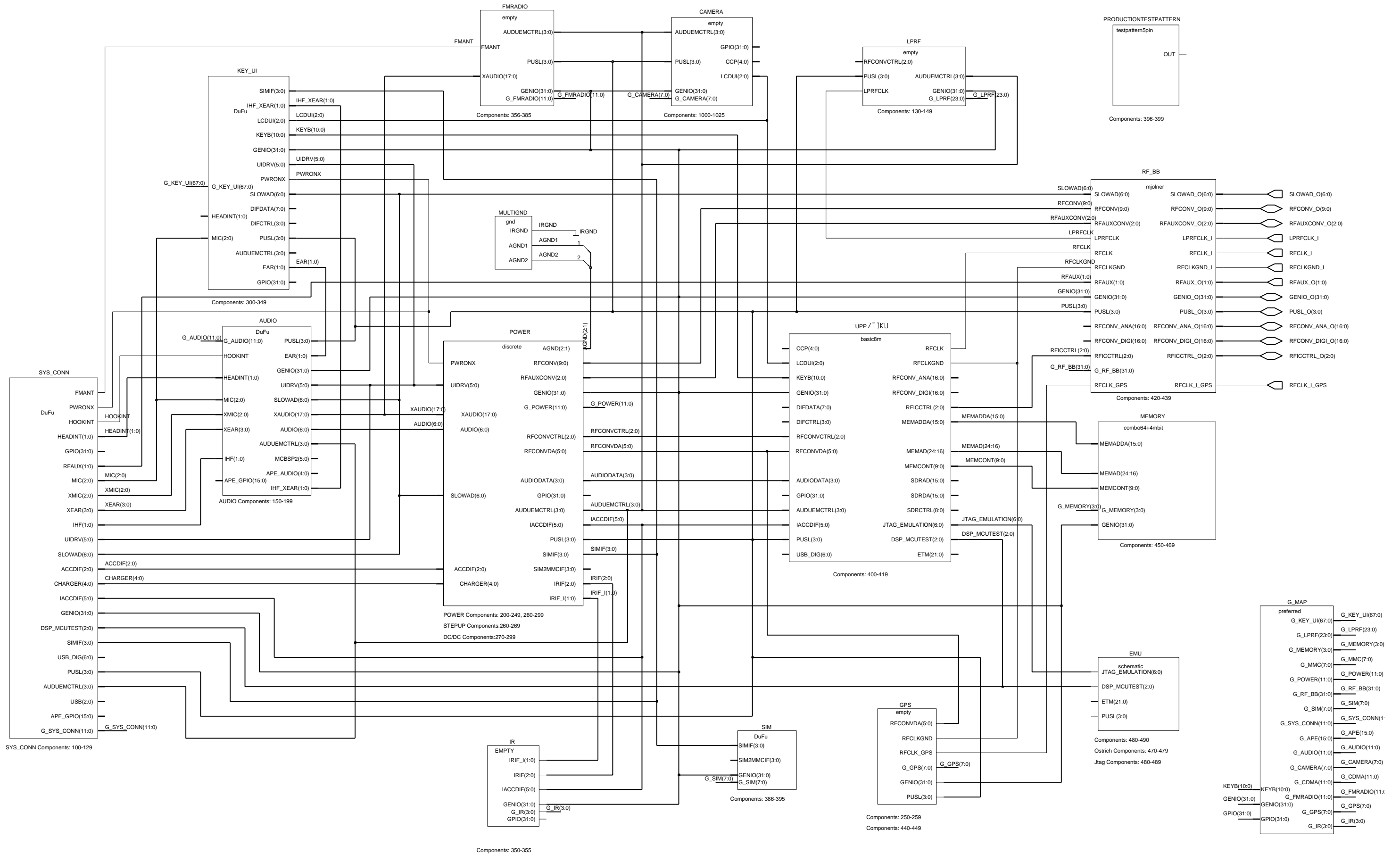

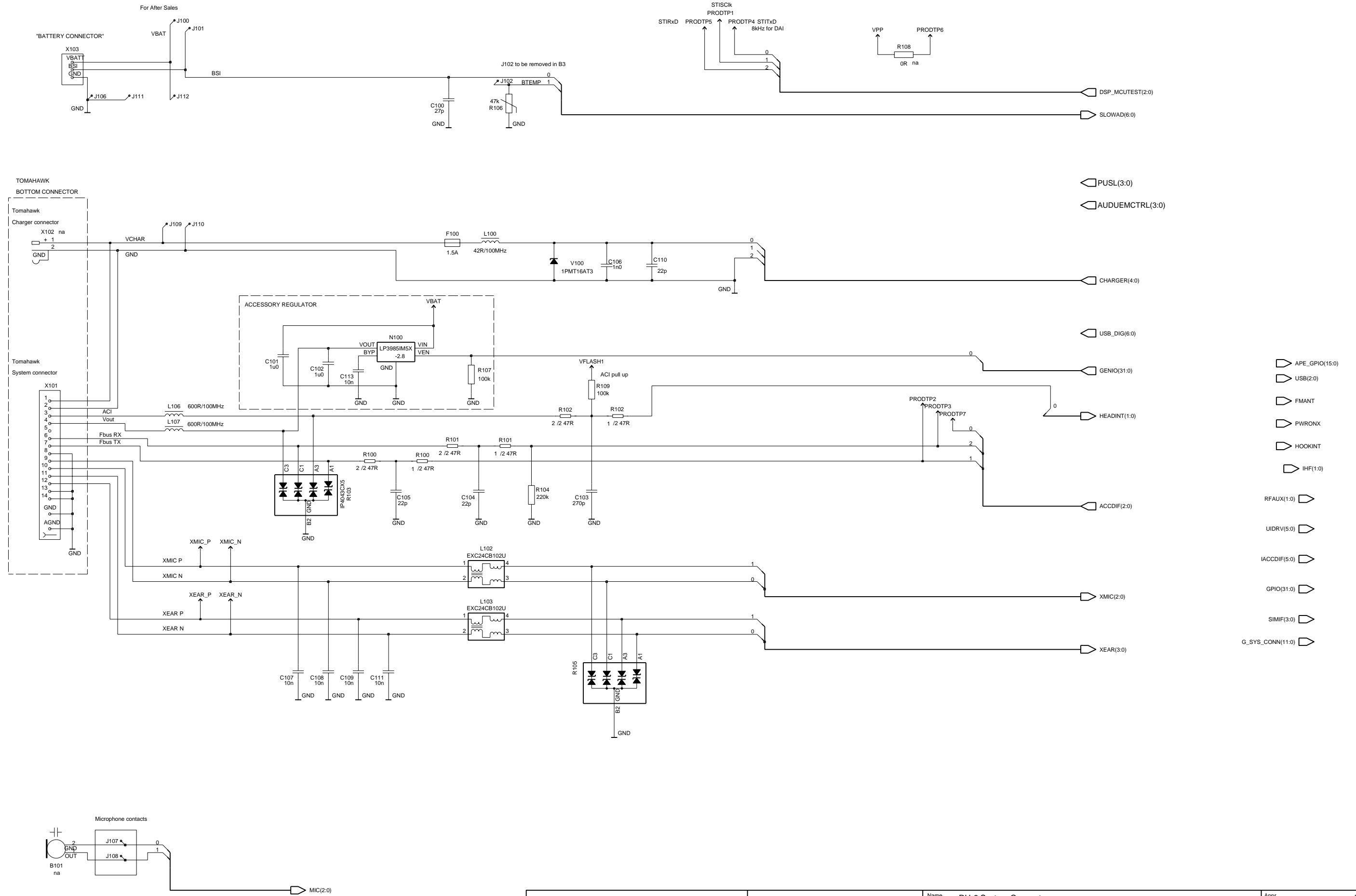

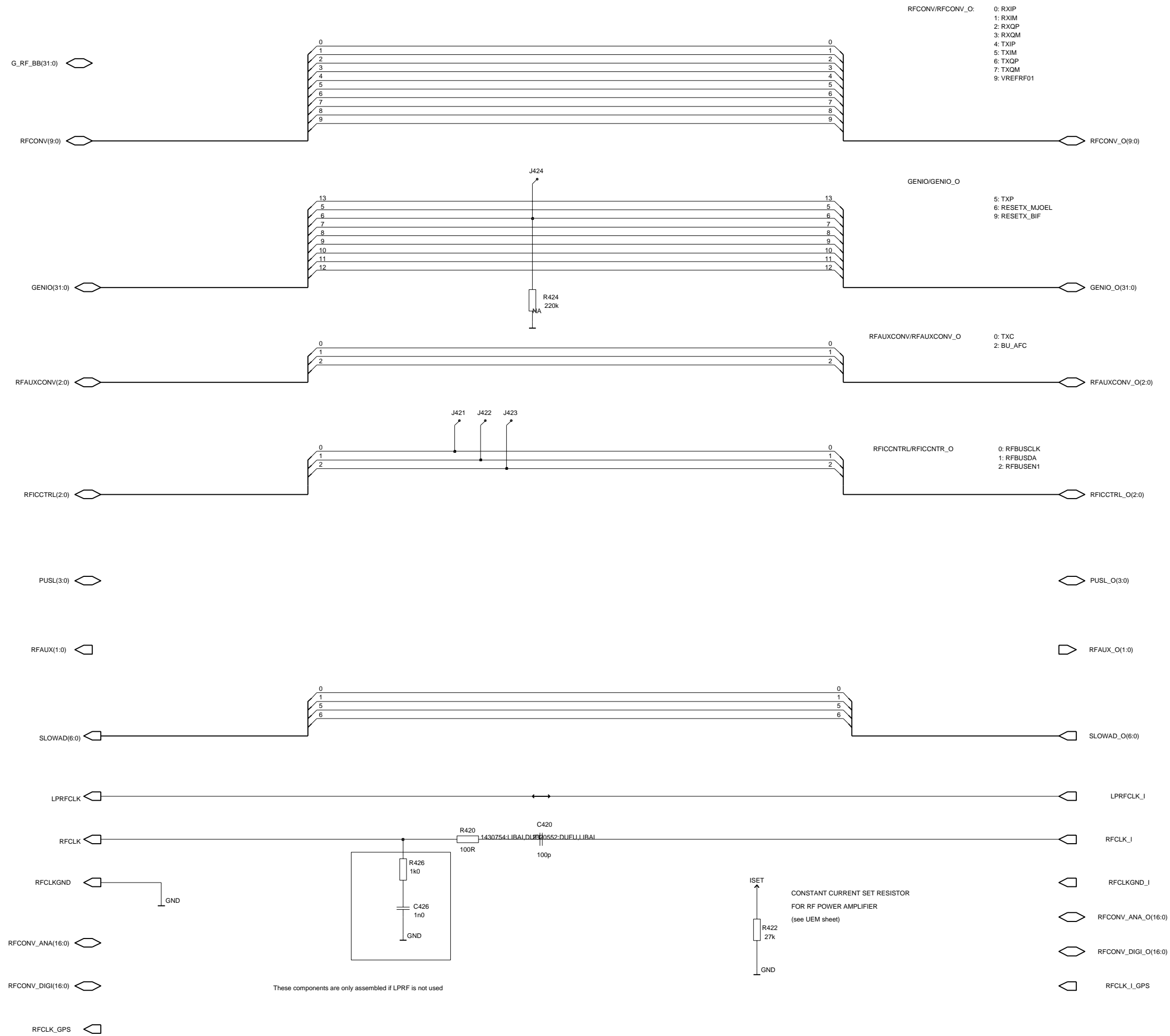

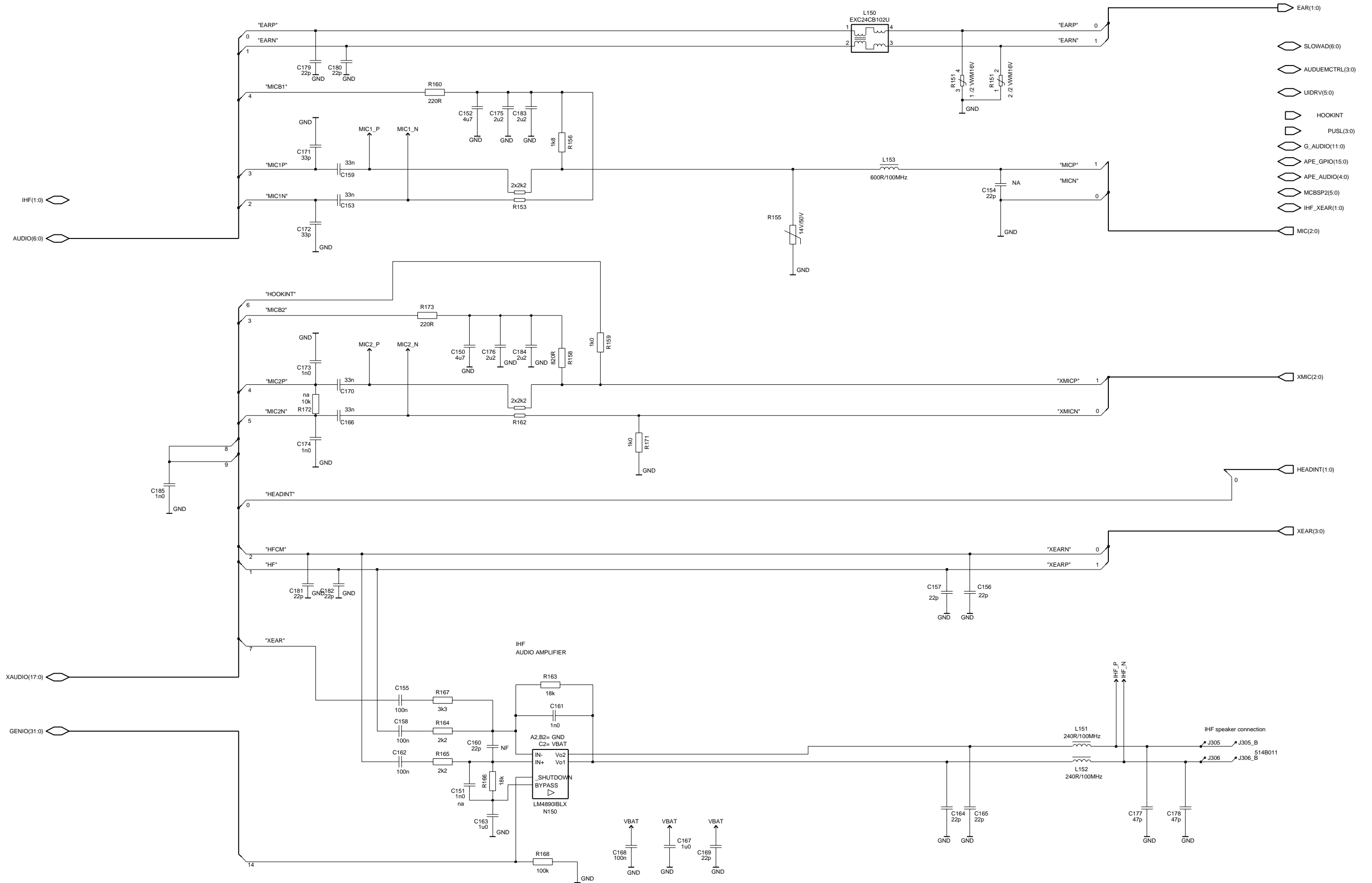

RH-6 Audio

Varistor arrays have reliability issues

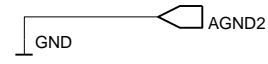
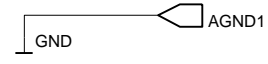
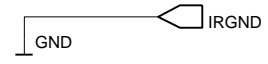





GENIO(31:0) 

GPIO(31:0) 

KEYB(10:0) 

 G_APE(15:0)

 G_AUDIO(11:0)

 G_CAMERA(7:0)

 G_CDMA(11:0)

 G_FMRADIO(11:0)

 G_GPS(7:0)

 G_IR(3:0)

 G_KEY_UI(67:0)

 G_LPRF(23:0)

 G_MEMORY(3:0)

 G_MMC(7:0)

 G_POWER(11:0)

 G_RF_BB(31:0)

 G_SIM(7:0)

 G_SYS_CONN(11:0)

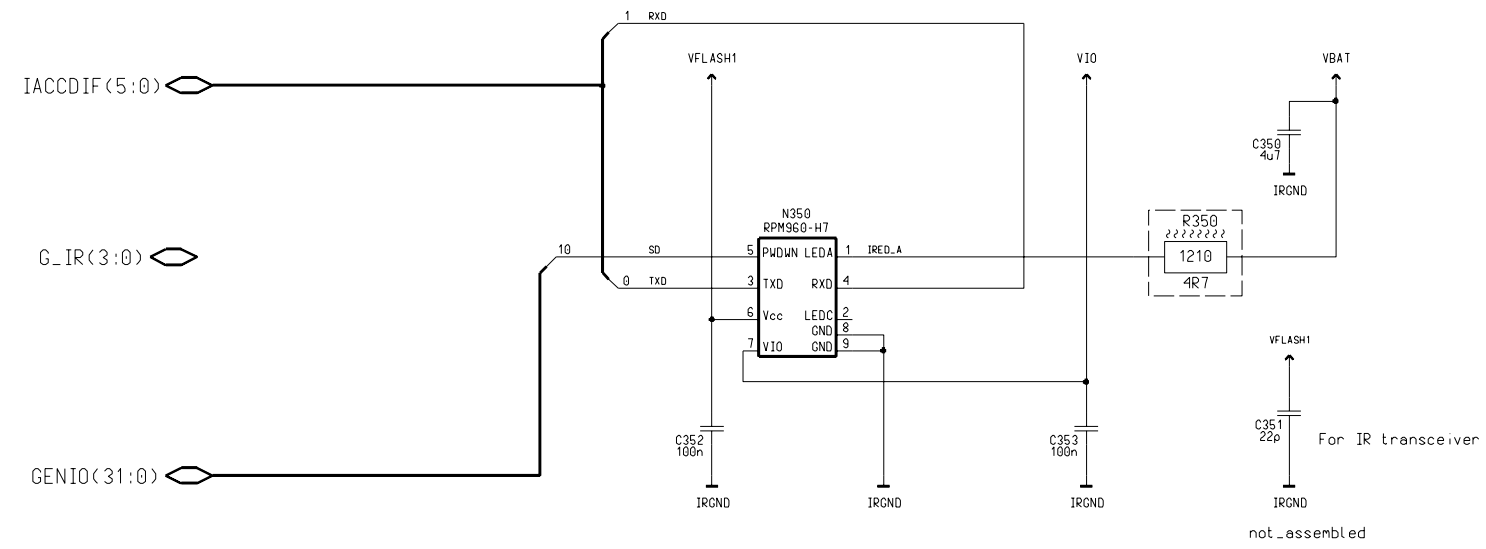

GPIO (31:0)

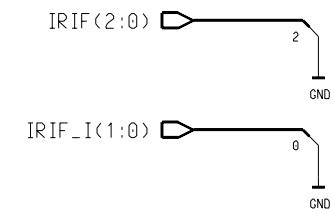

UEM IR level shifters are ground, when 1.8V IR is used!

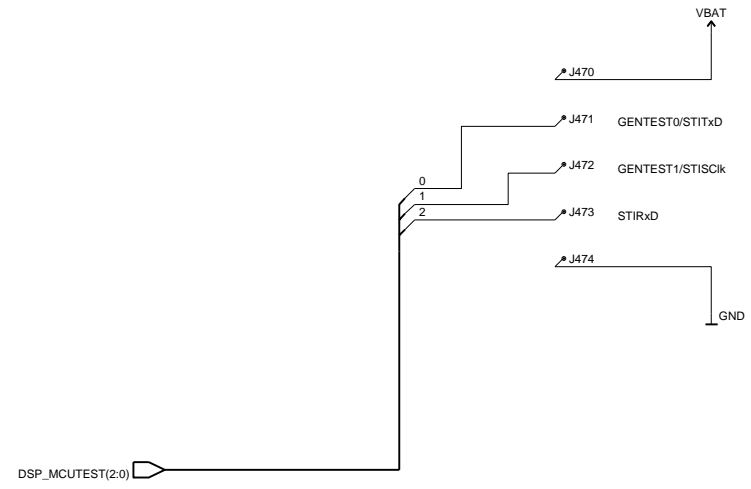

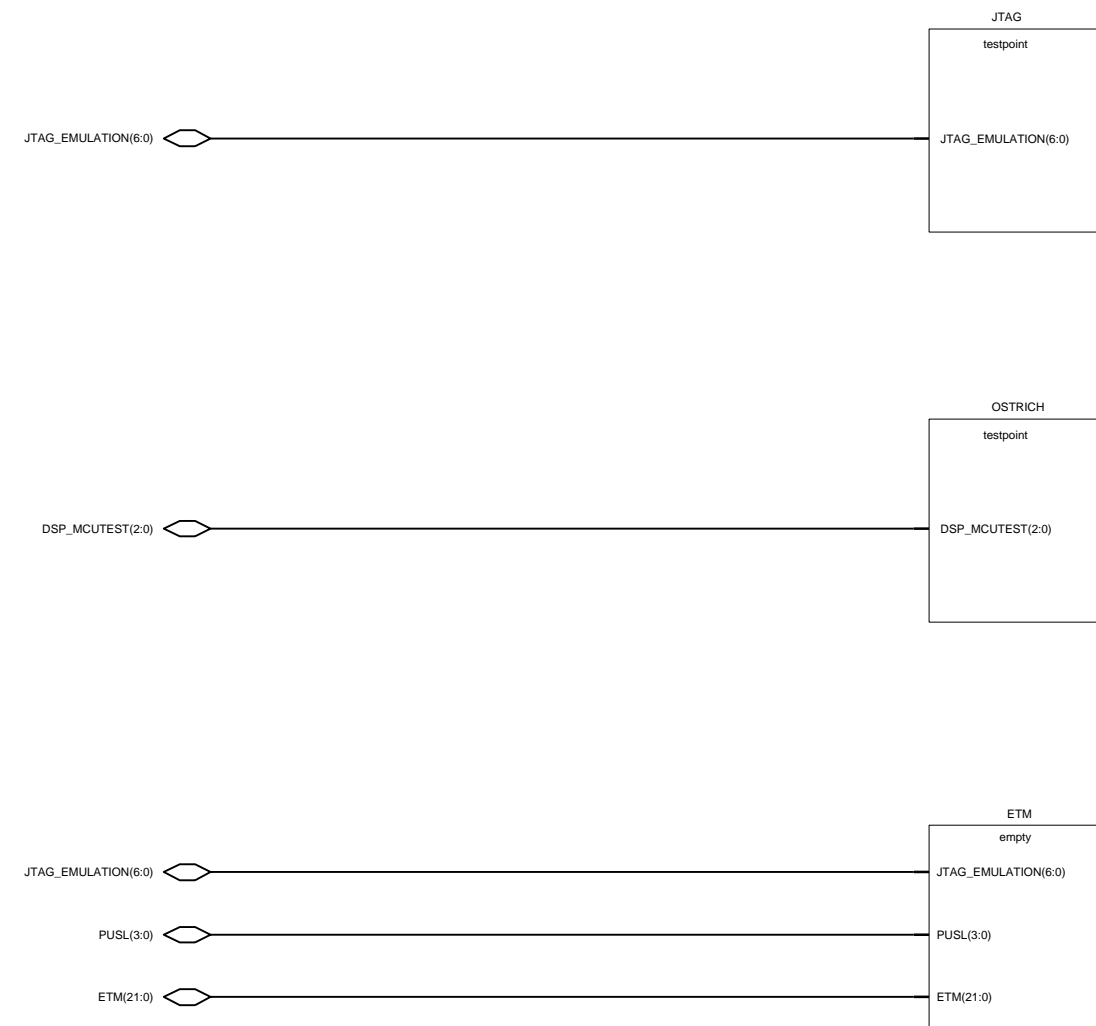

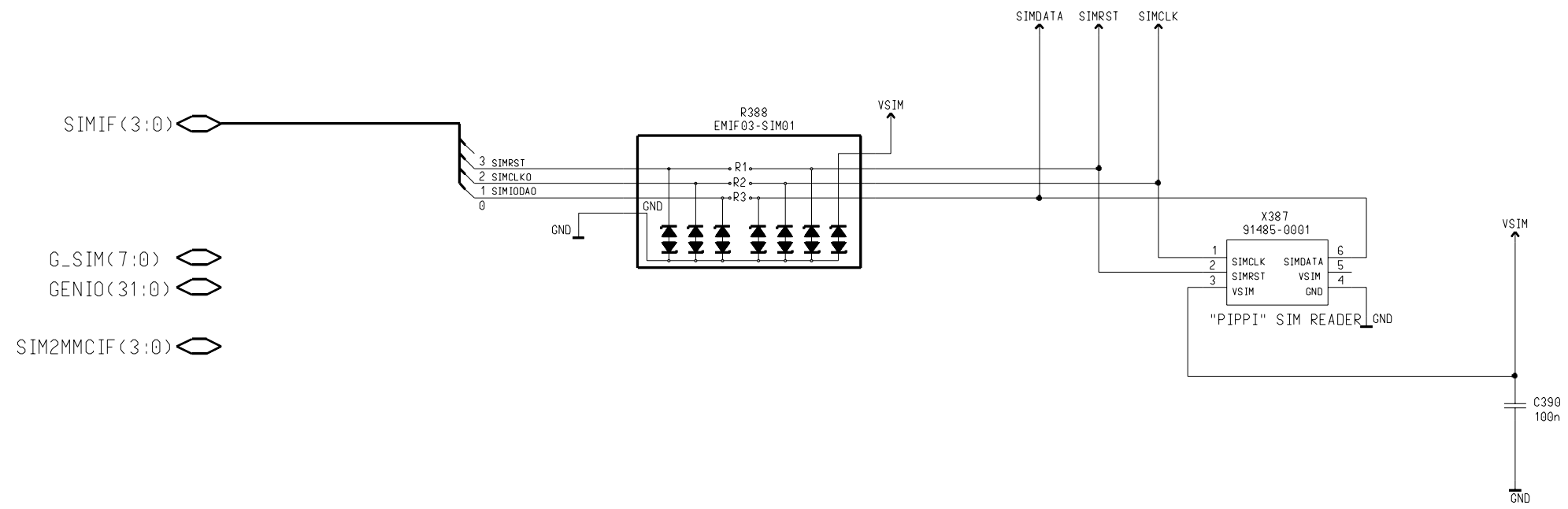

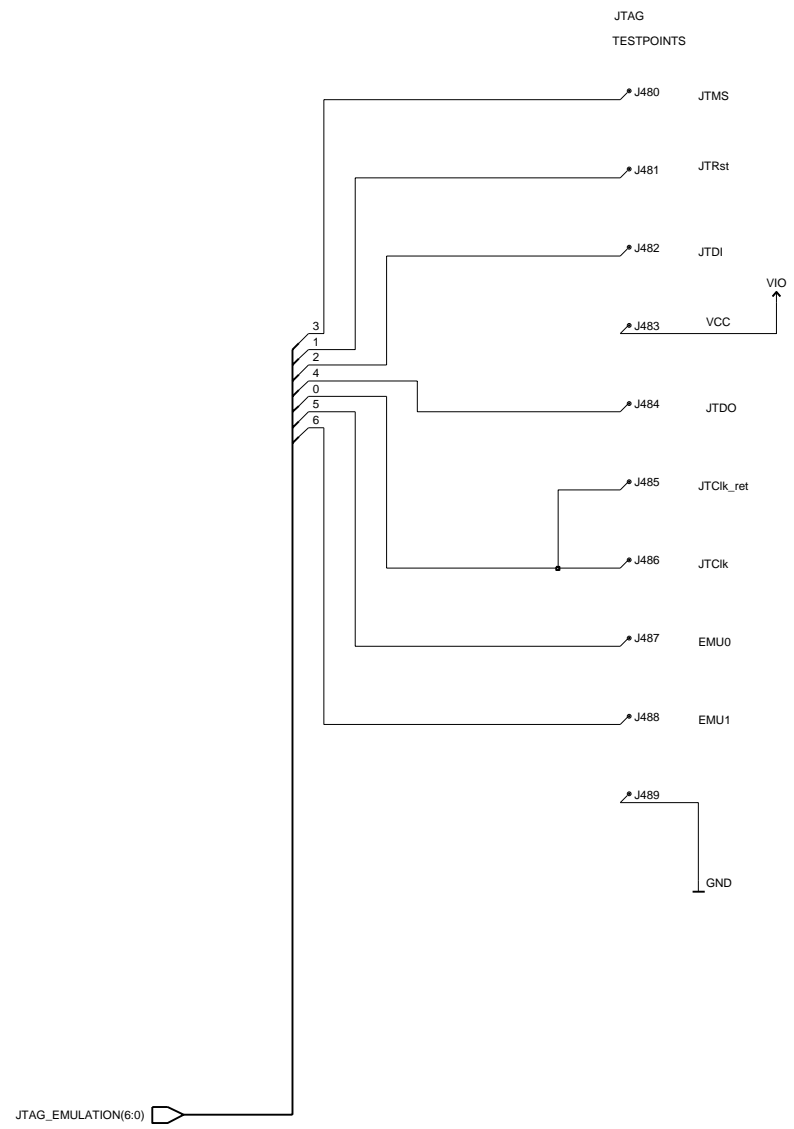

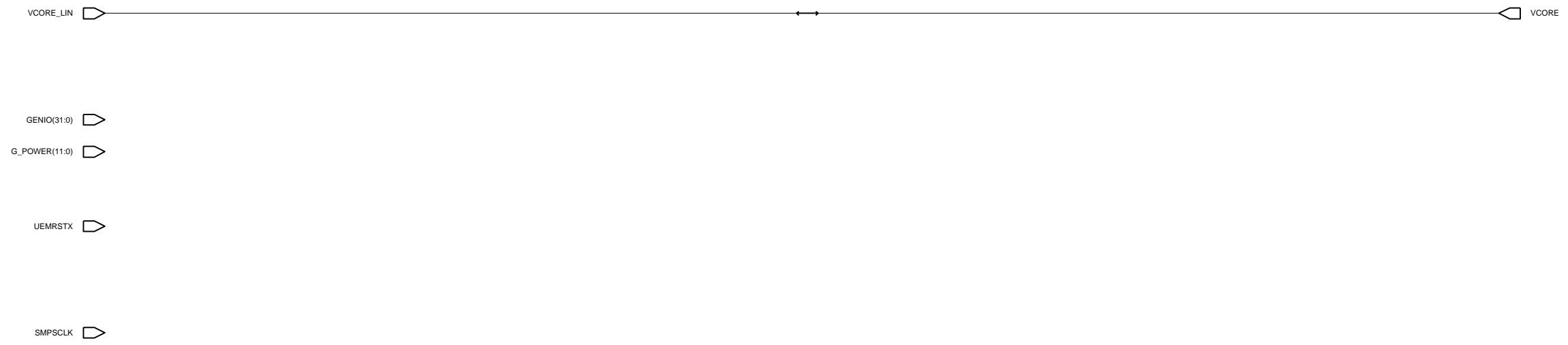

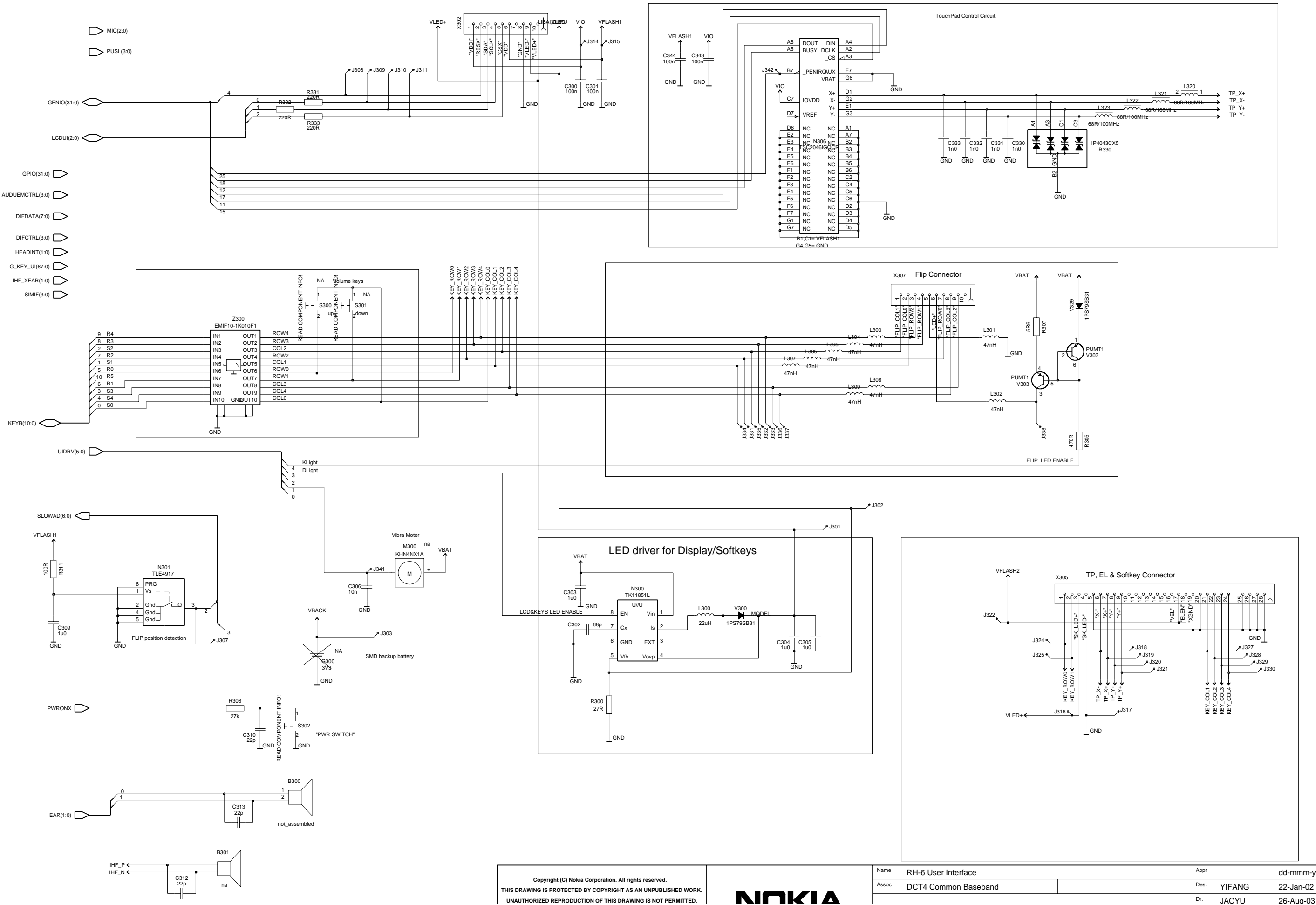

Copyright (C) Nokia Corporation. All rights reserved.
 THIS DRAWING IS PROTECTED BY COPYRIGHT AS AN UNPUBLISHED WORK.
 UNAUTHORIZED REPRODUCTION OF THIS DRAWING IS NOT PERMITTED.



Name	RH-6 User Interface	Appr	dd-mmm-y
Assoc	DCT4 Common Baseband	Des.	YIFANG 22-Jan-02
		Dr.	JACYU 26-Aug-03

Discrete Power Management

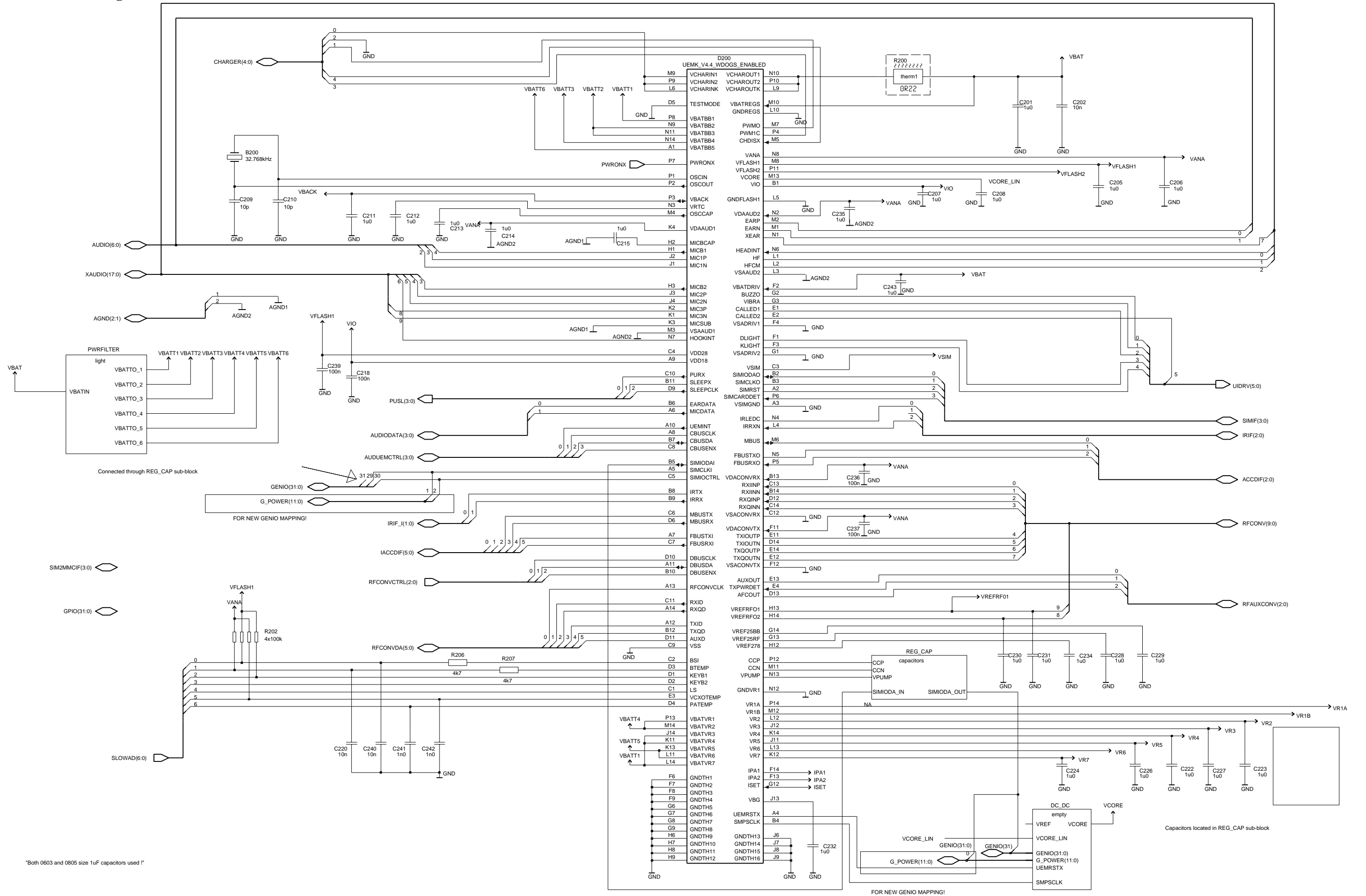

*Both 0603 and 0805 size 1uF capacitors used !

Used refs in REG_CAP: C238, C200, C219, C233, C221 and R205

Copyright (C) Nokia Corporation. All rights reserved

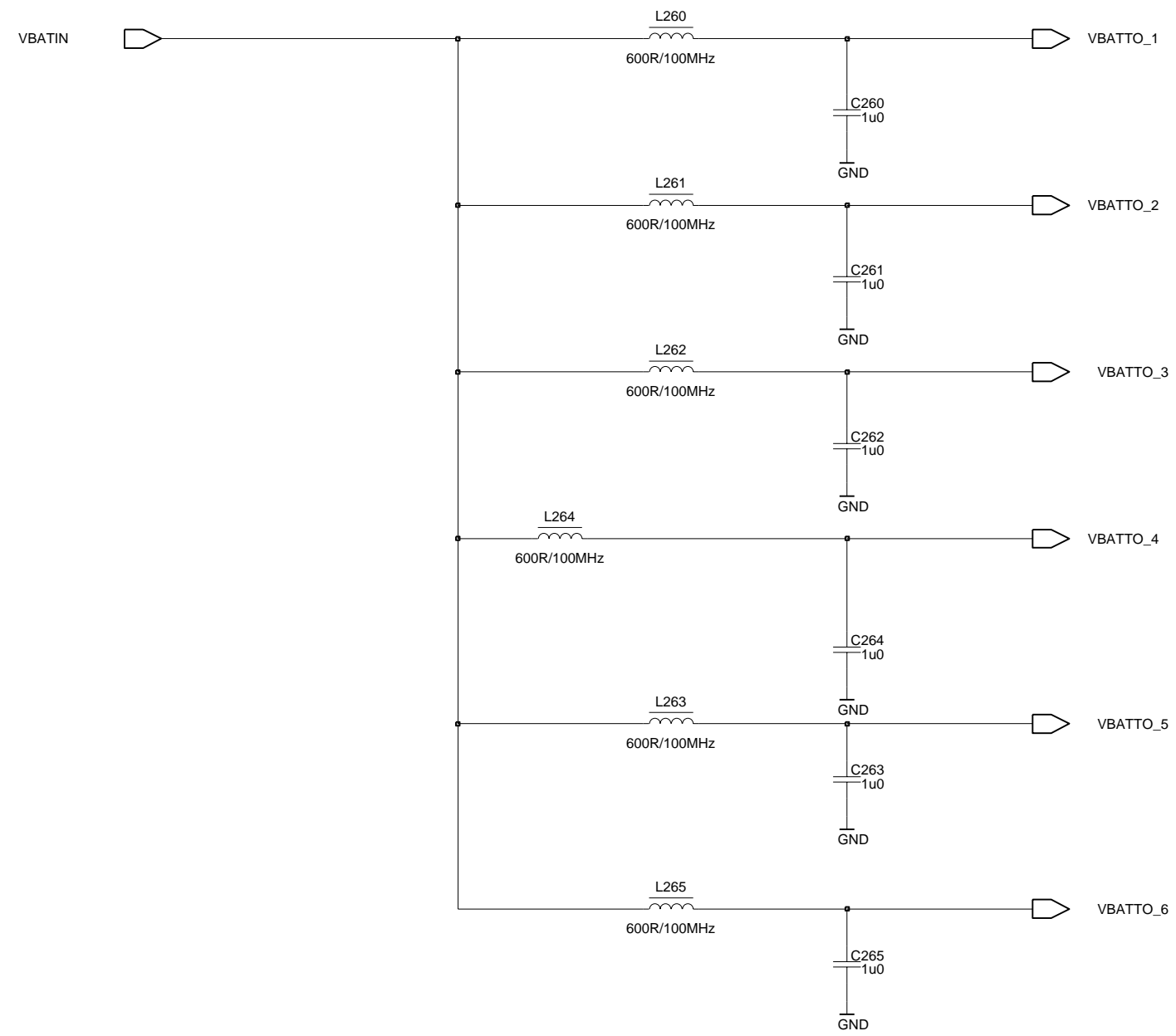

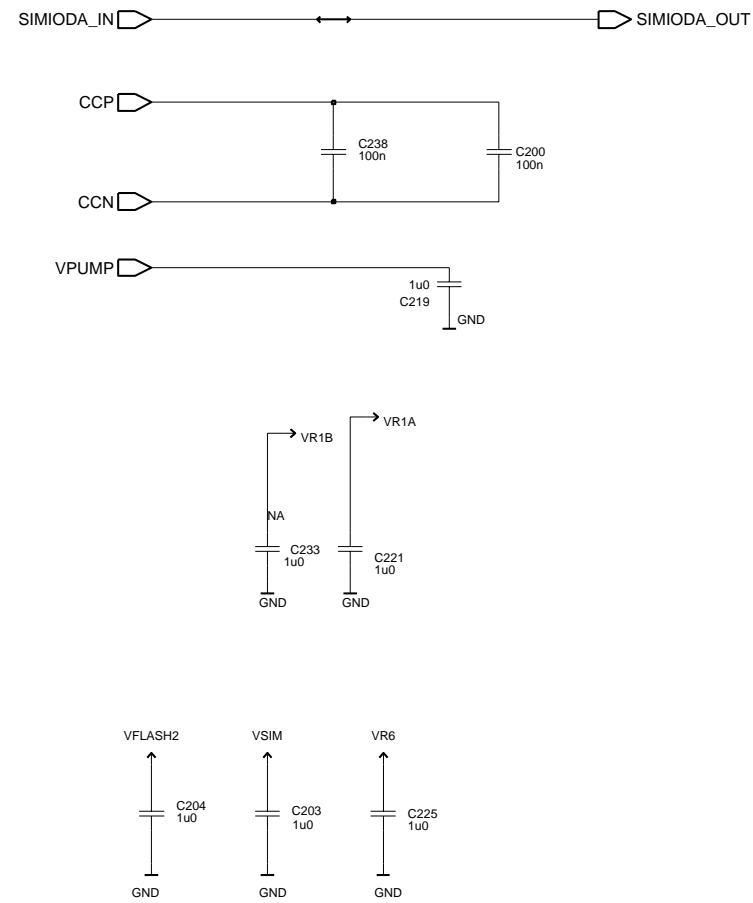

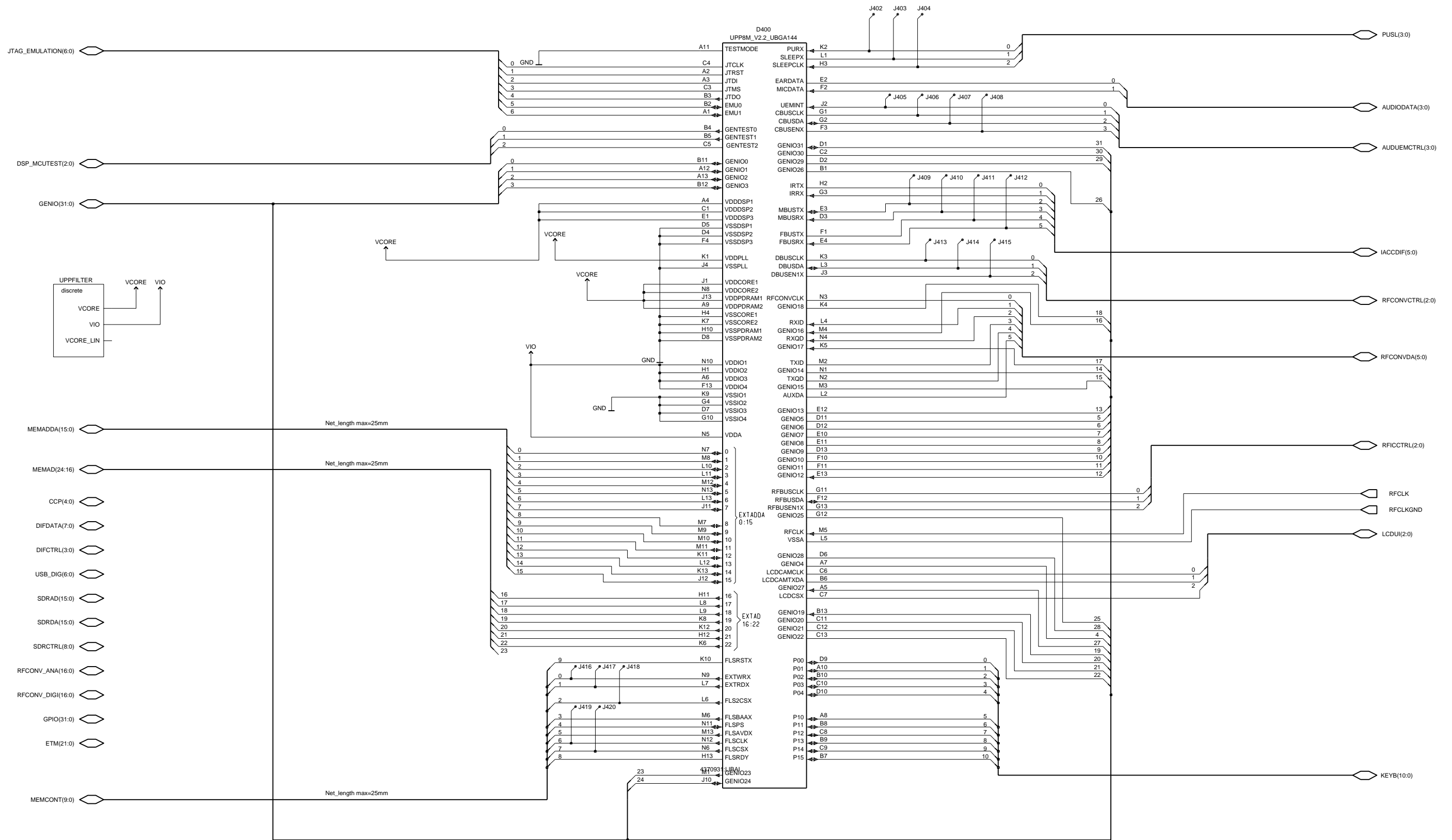

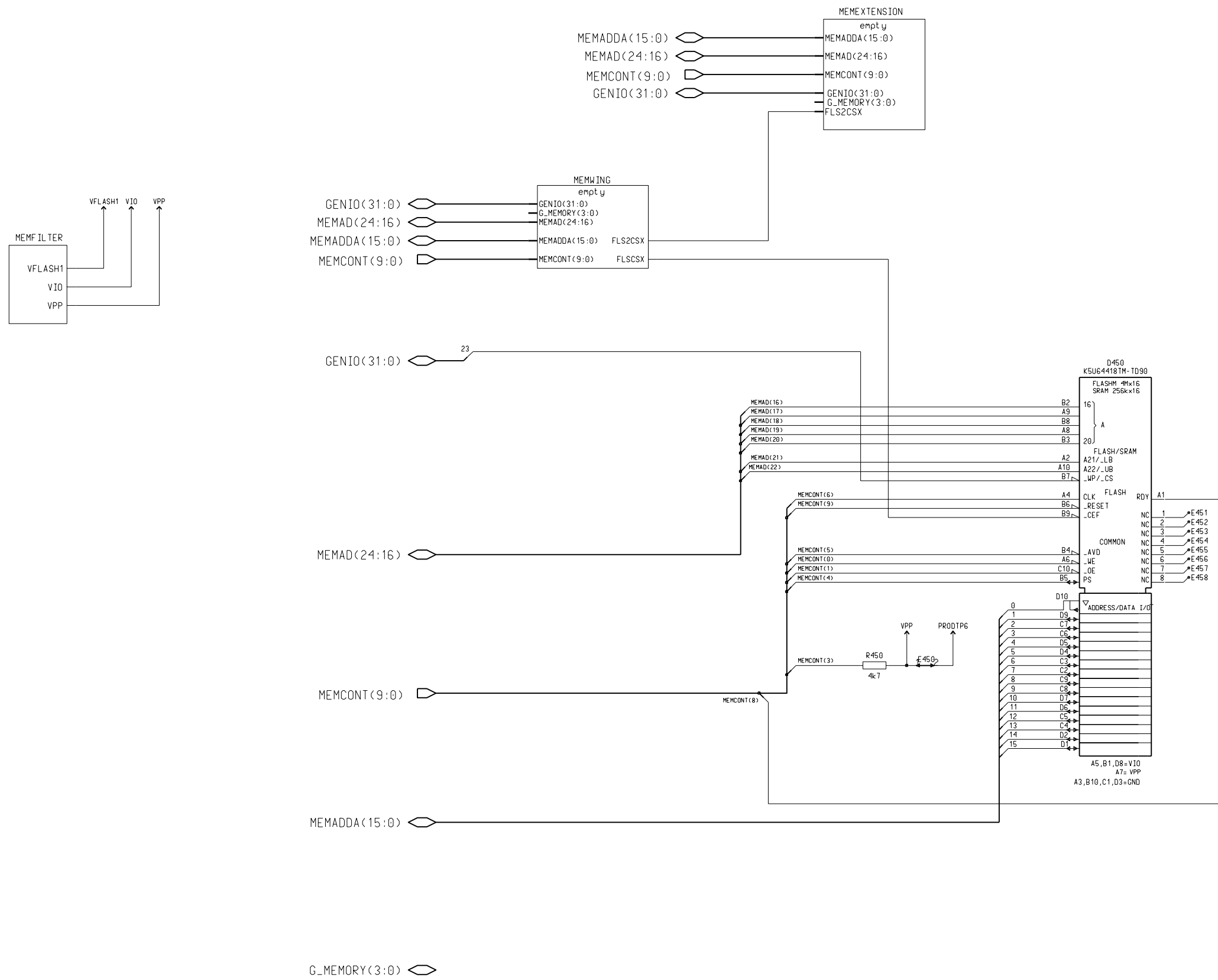

Discrete Decoupling Capacitors for UPP

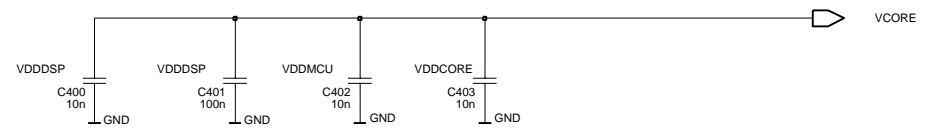

VDDCORE_LIN

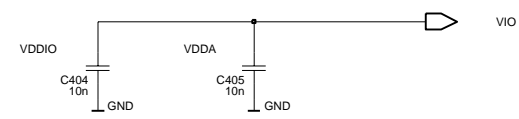

Discrete Capacitors for Memory without VFlash 1

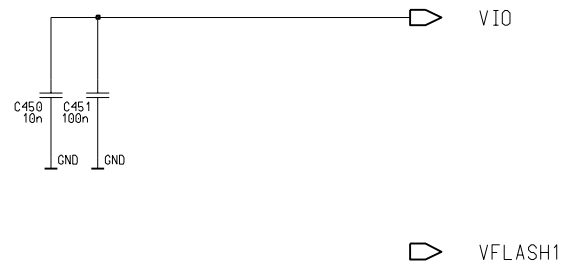

MEMADDA(15:0) ◁

MEMAD(24:16) ◁

GENIO(31:0) ◁

G_MEMORY(3:0) ◁

