

Audio

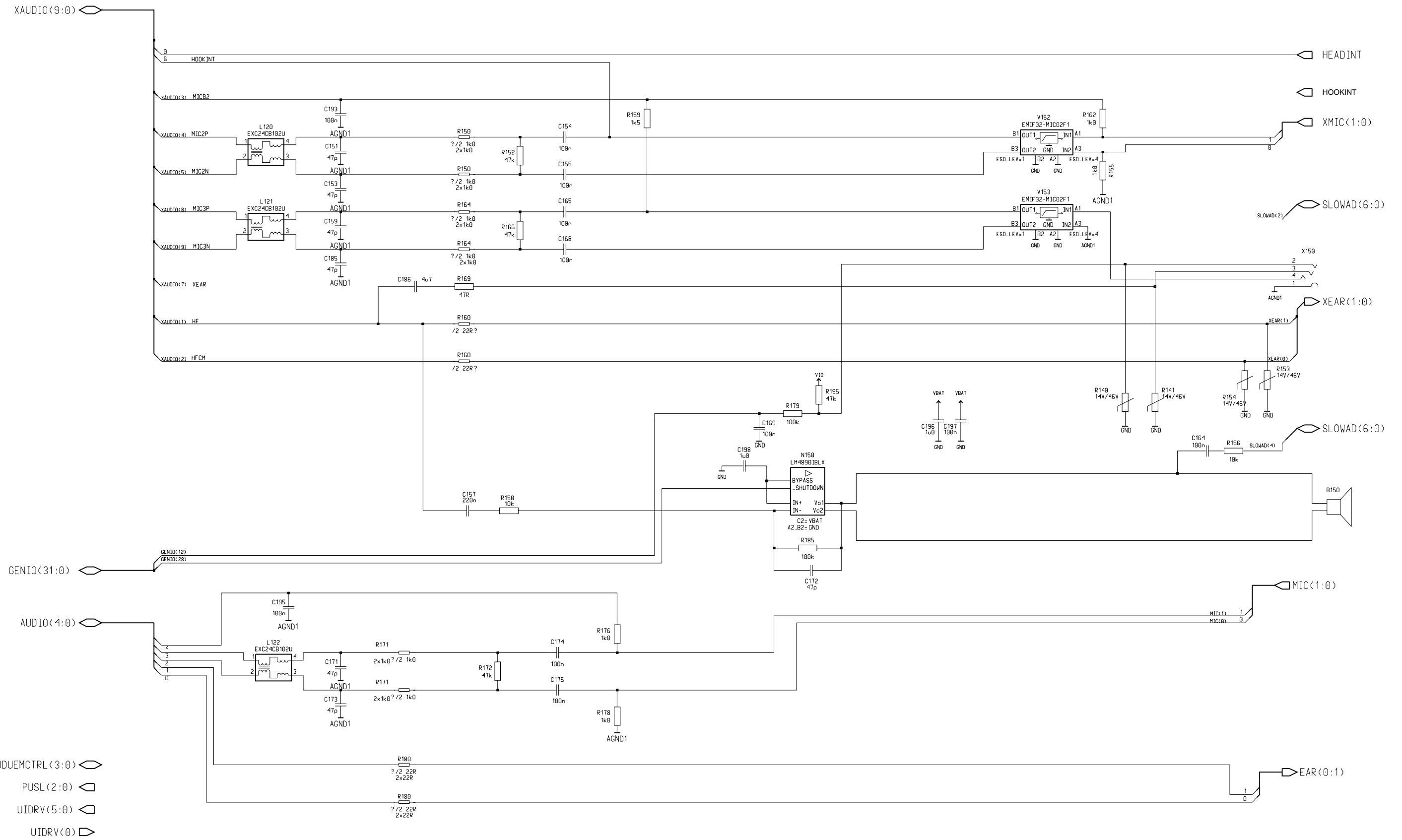

Circuit Diagram of RX (Batman)

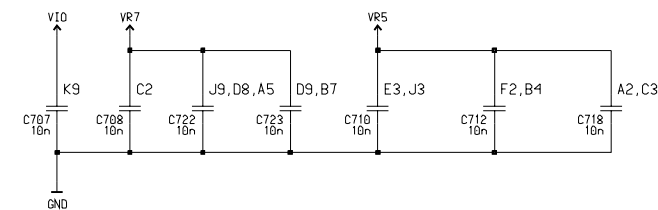
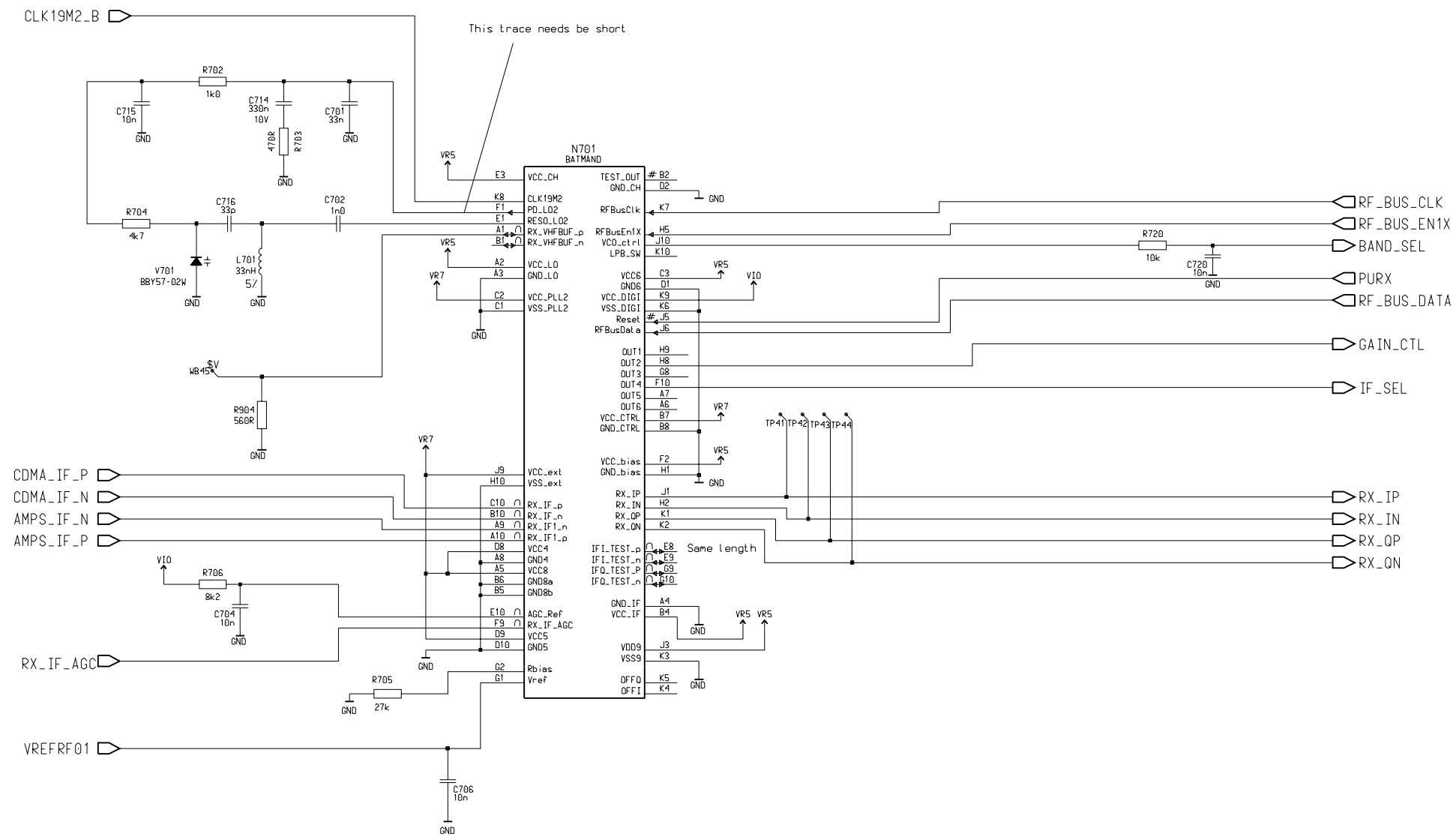

DC-DC Converter

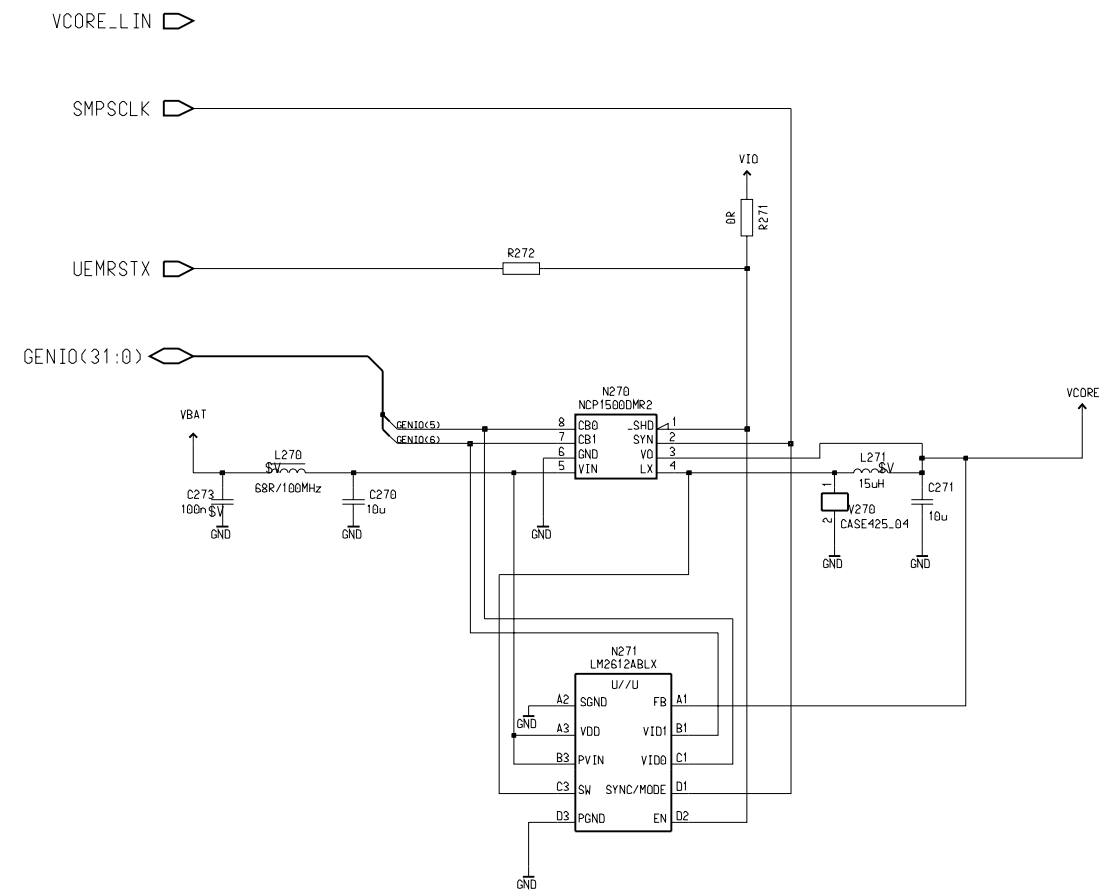

Circuit Diagram of Test and Emulator Interface



Circuit Diagram of RX front end

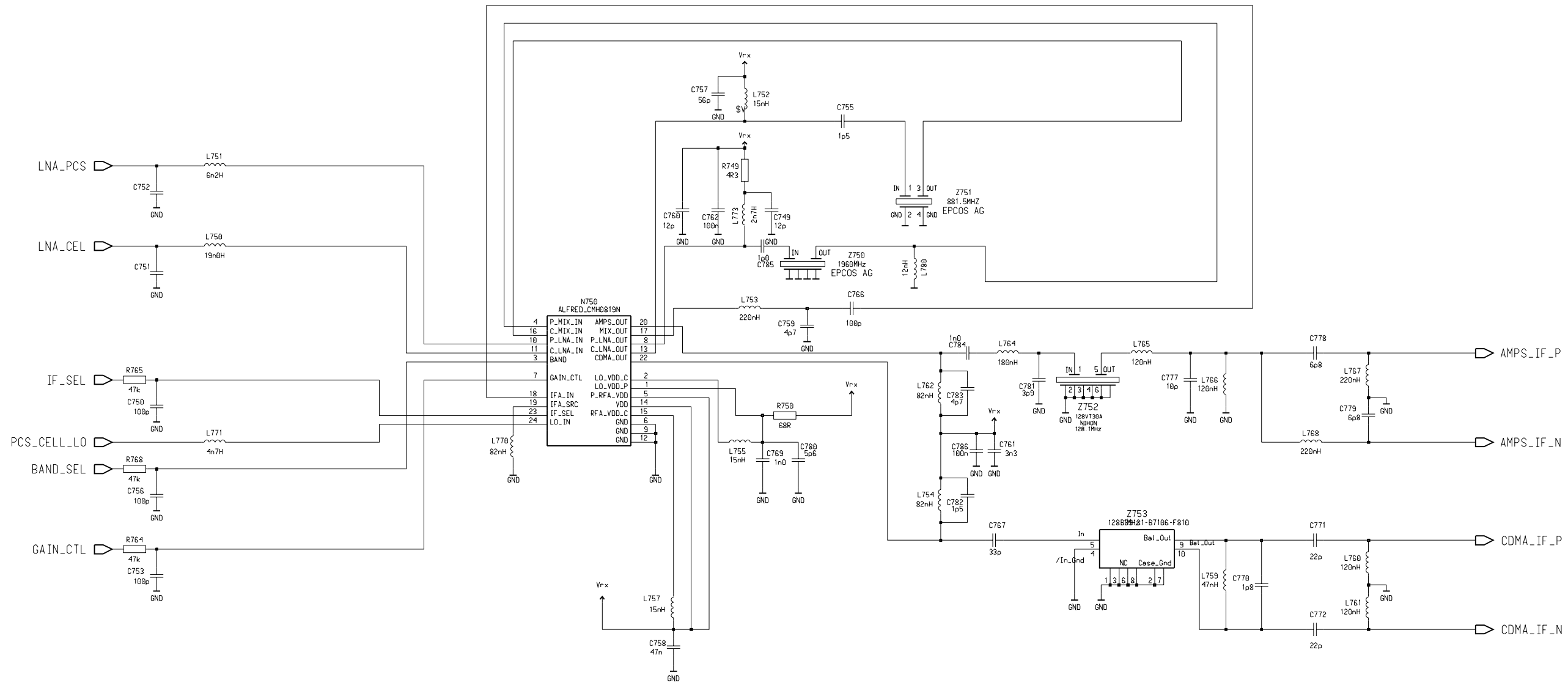

MODES	LOGIC INPUTS		
	BAND	GAIN_CTL	IF_SEL
CEL CDMA Hi Gain	0	1	0
CEL CDMA Lo Gain	0	0	0
PCS CDMA Hi Gain	1	1	0
PCS CDMA Lo Gain	1	0	0
AMPS Hi Gain	0	1	1
AMPS Lo Gain	0	0	1

UPP Decoupling Diagram

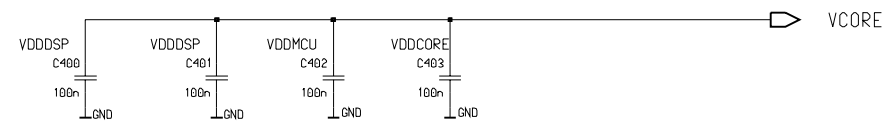

Place caps near UPP

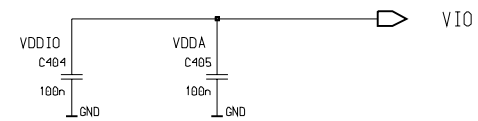

JTAG Emulator Connector and Buffers



MultiGND Connecting Audio GNDs to Global GNDs

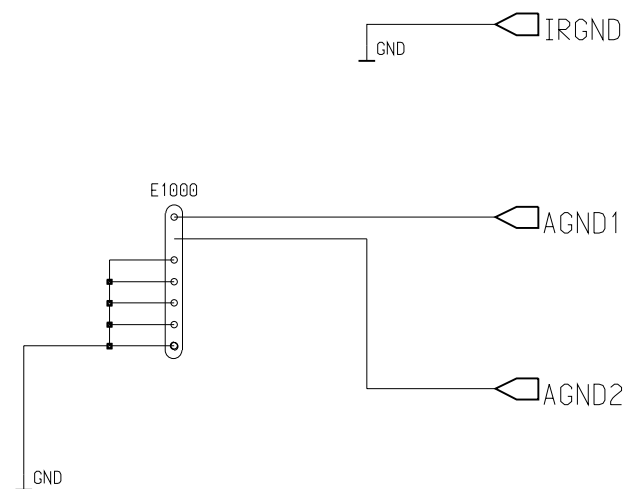

Circuit Diagram of Memory Configuration

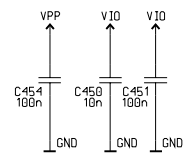
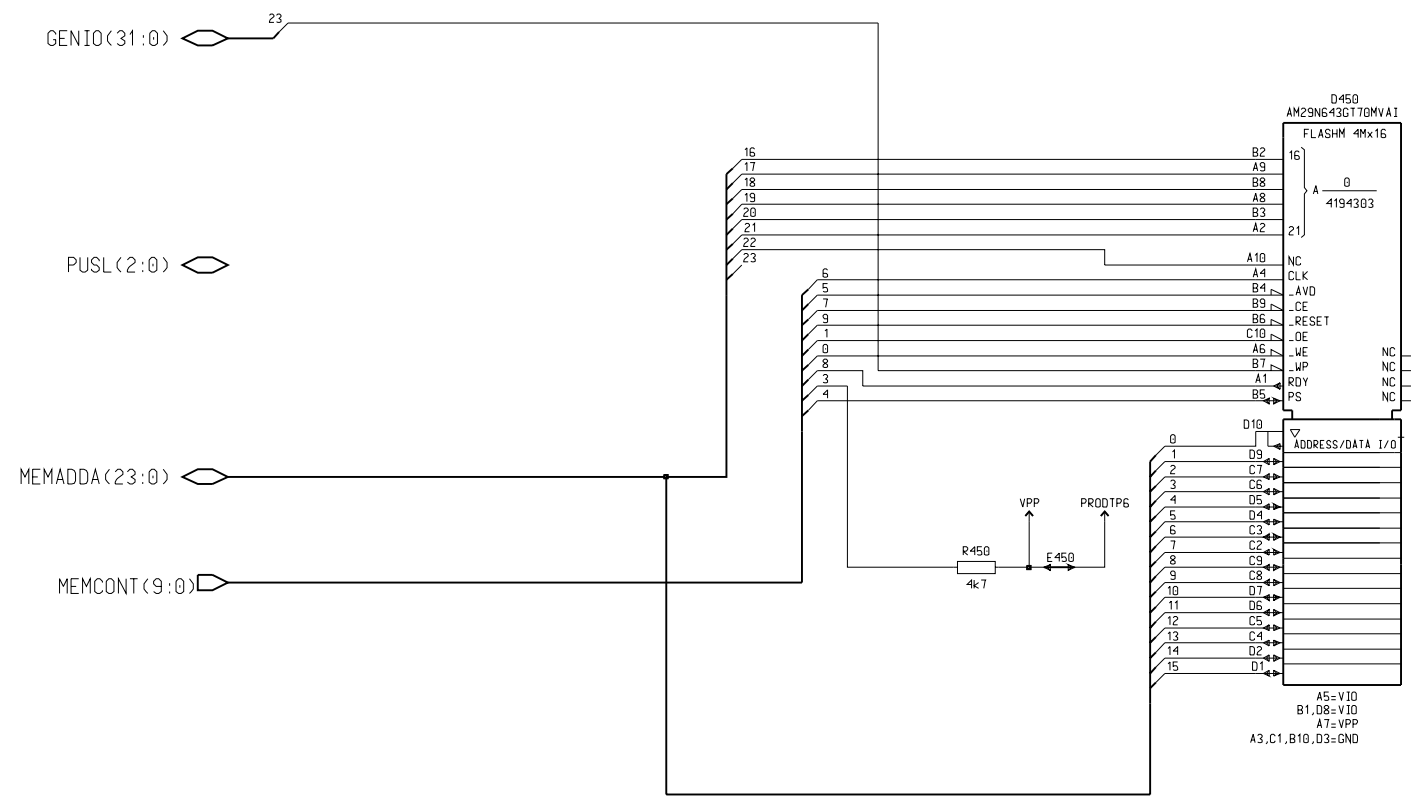

Circuit Diagram of Ostrich Test Interface

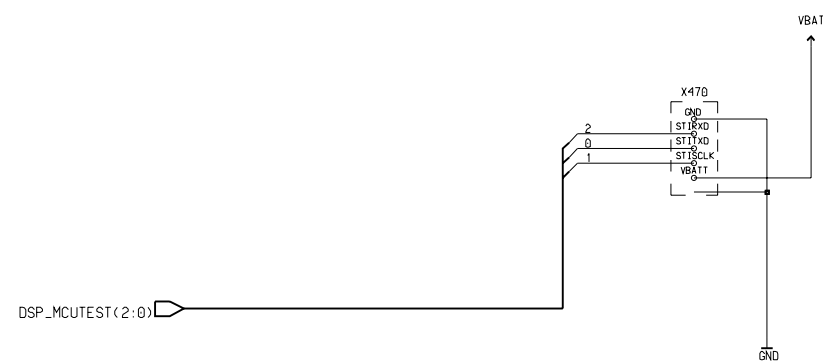

Circuit Diagram of PA

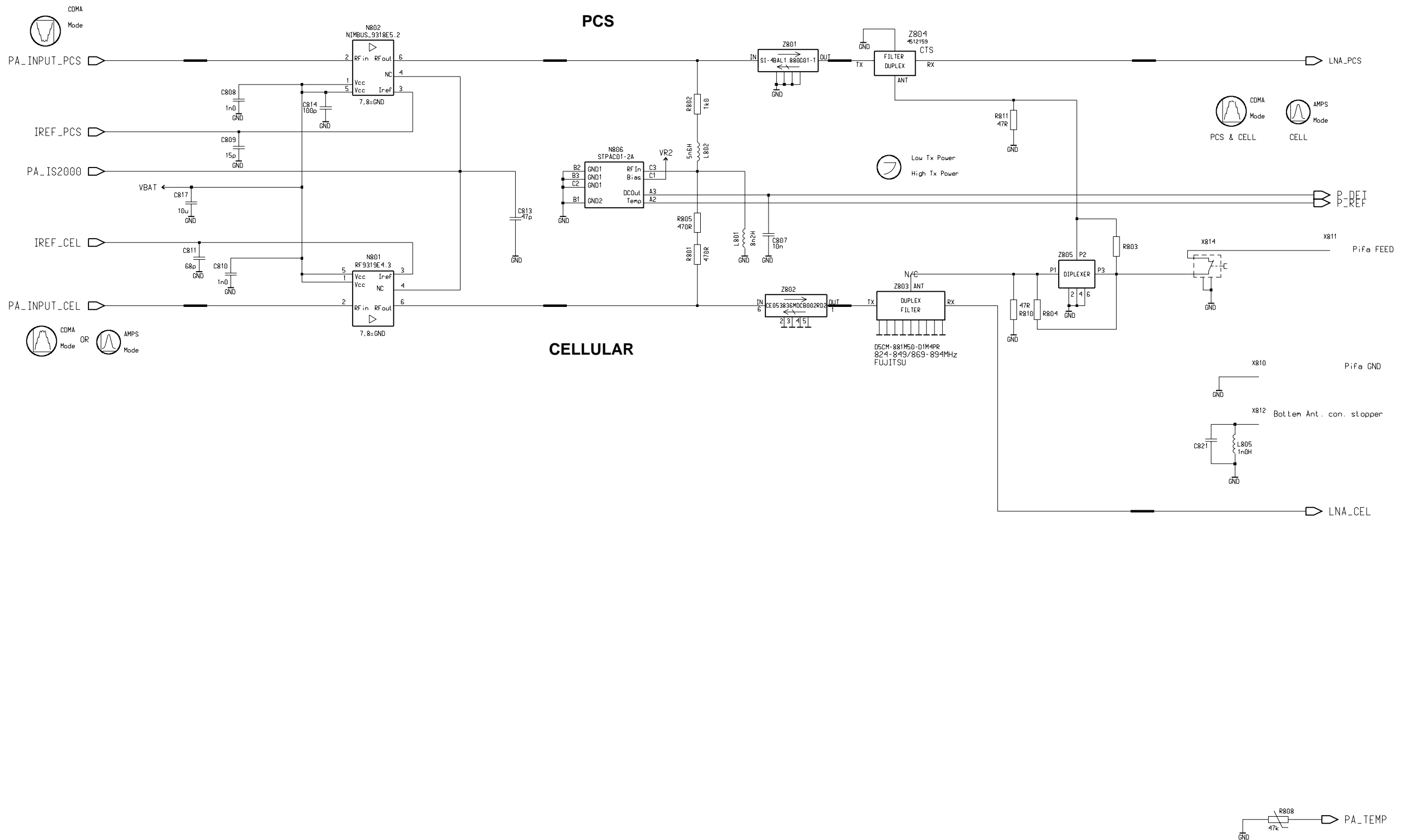

Circuit Diagram of Common Baseband

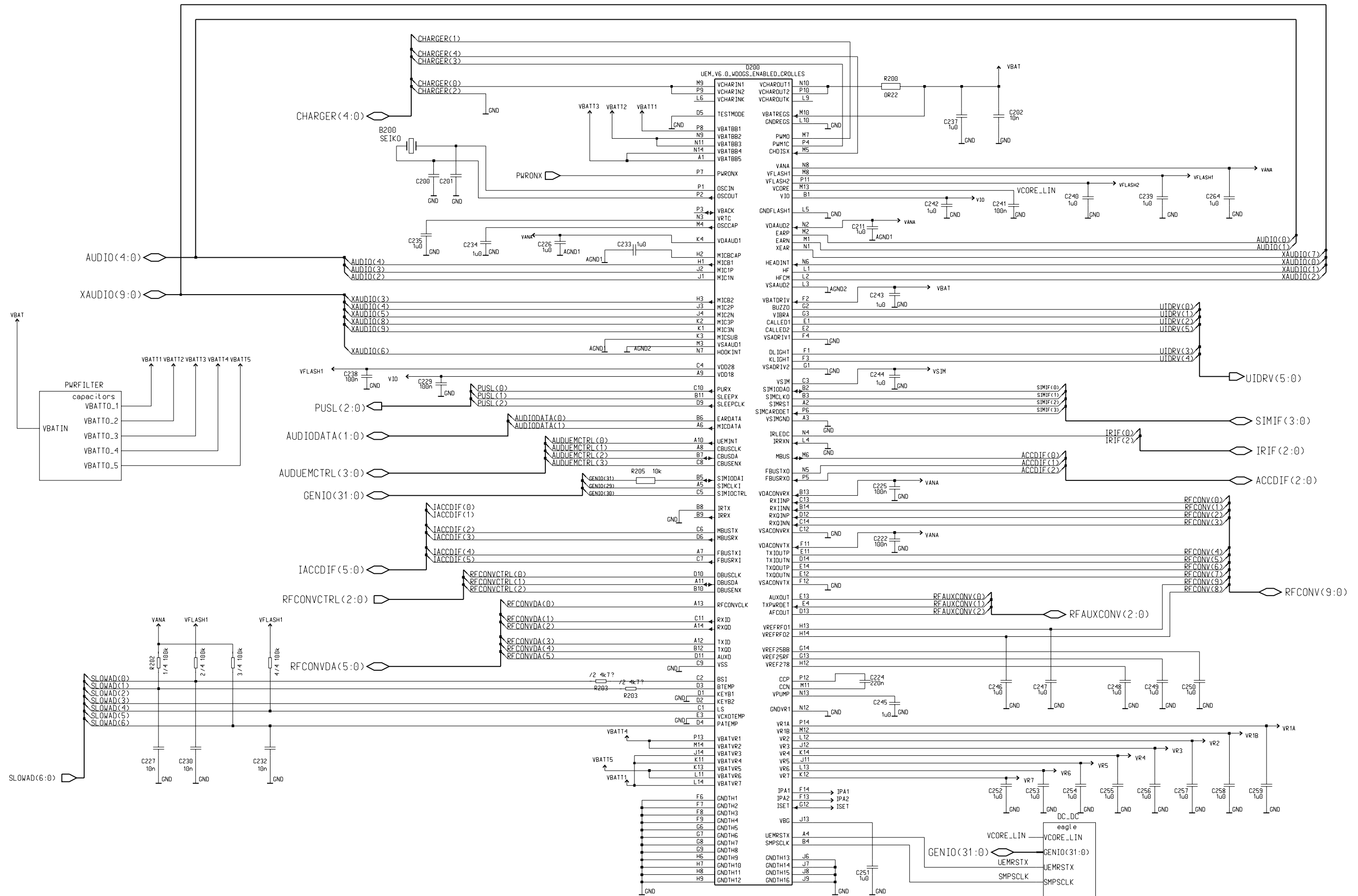

Circuit Diagram of DCT4 Power Supply

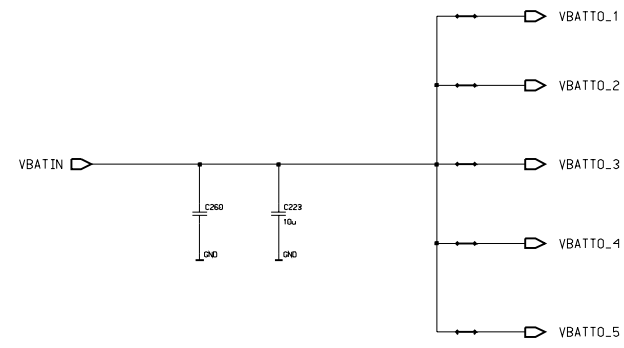

5-pin Production Test Pattern

OUT

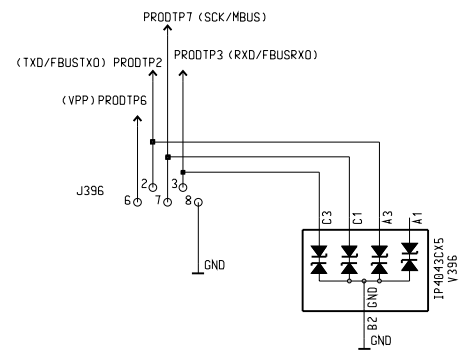

Circuit Diagram of RF

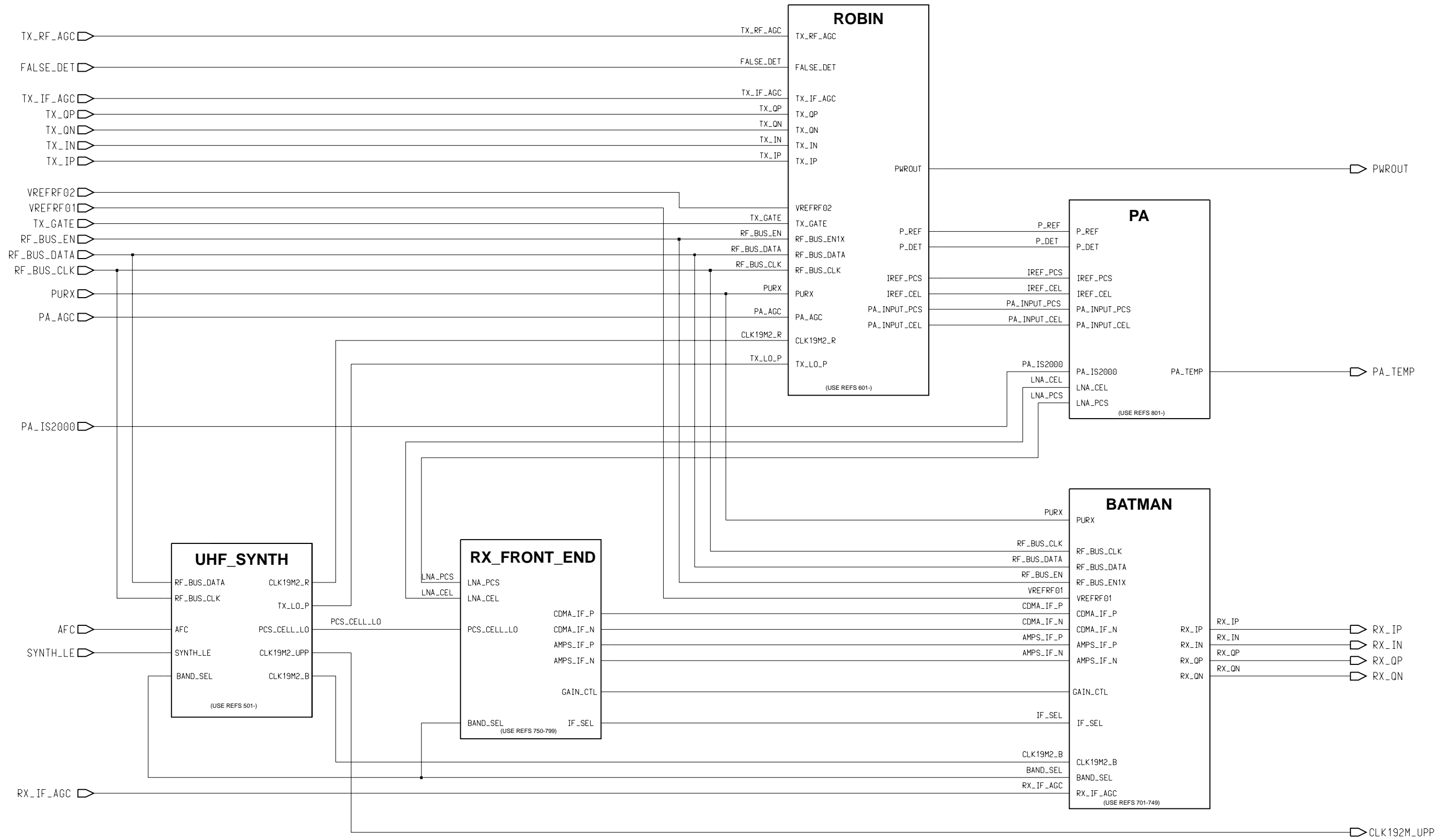

Circuit Diagram of RF-BB Interface

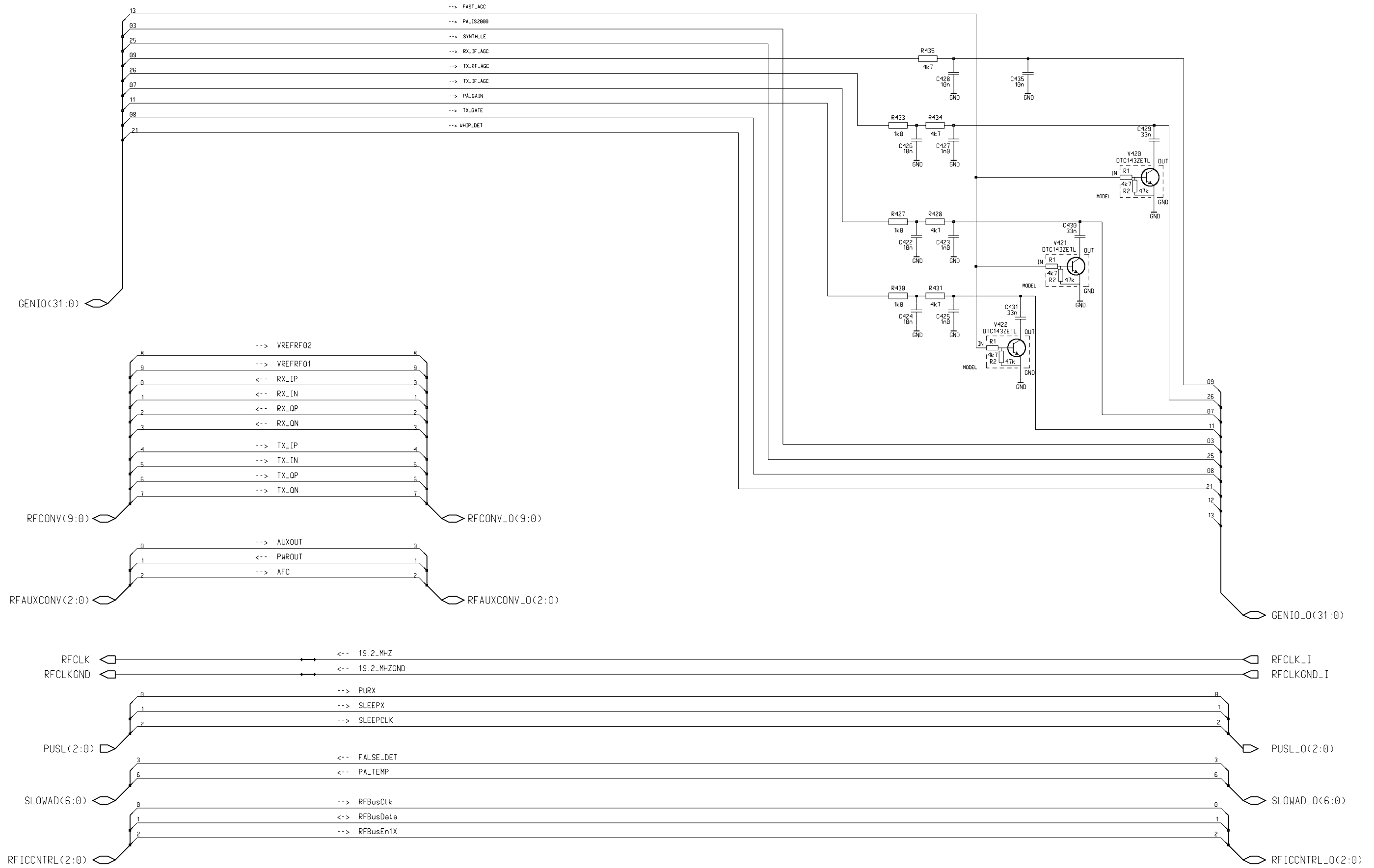

Circuit Diagram of Robin

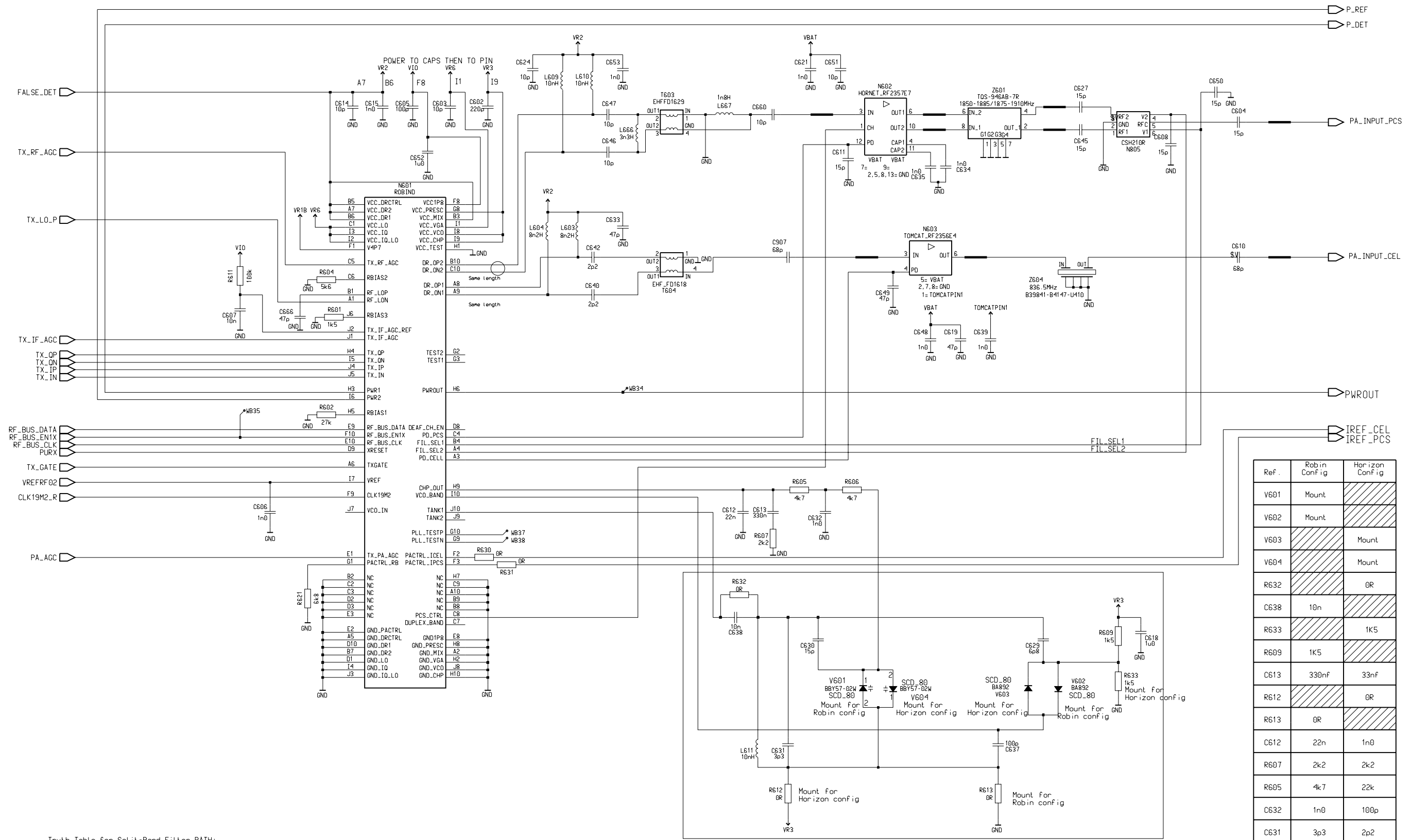

Truth Table for Split-Band Filter PATH:

DRV CNTL	DRV OUT STATE	VCONT1	VCONT2	SWITCH IN STATE
0 volt	RFOUT1	0 volt	2.7 volt	RF11
2.7 volt	RFOUT2	2.7 volt	0 volt	RF12

VCO_BAND	
Cell band	low (shorted to ground)
PCS band	tri-stated (open circuit)

Ref.	Robin Config	Horizon Config
V601	Mount	
V602	Mount	
V603		Mount
V604		Mount
R632		0R
C638	10n	
R633		1K5
R609	1K5	
C613	330nf	33nf
R612		0R
R613	0R	
C612	22n	1n0
R607	2k2	2k2
C632	1n0	100p
C631	3p3	2p2

DCT4 Common Baseband Schematic (top level)

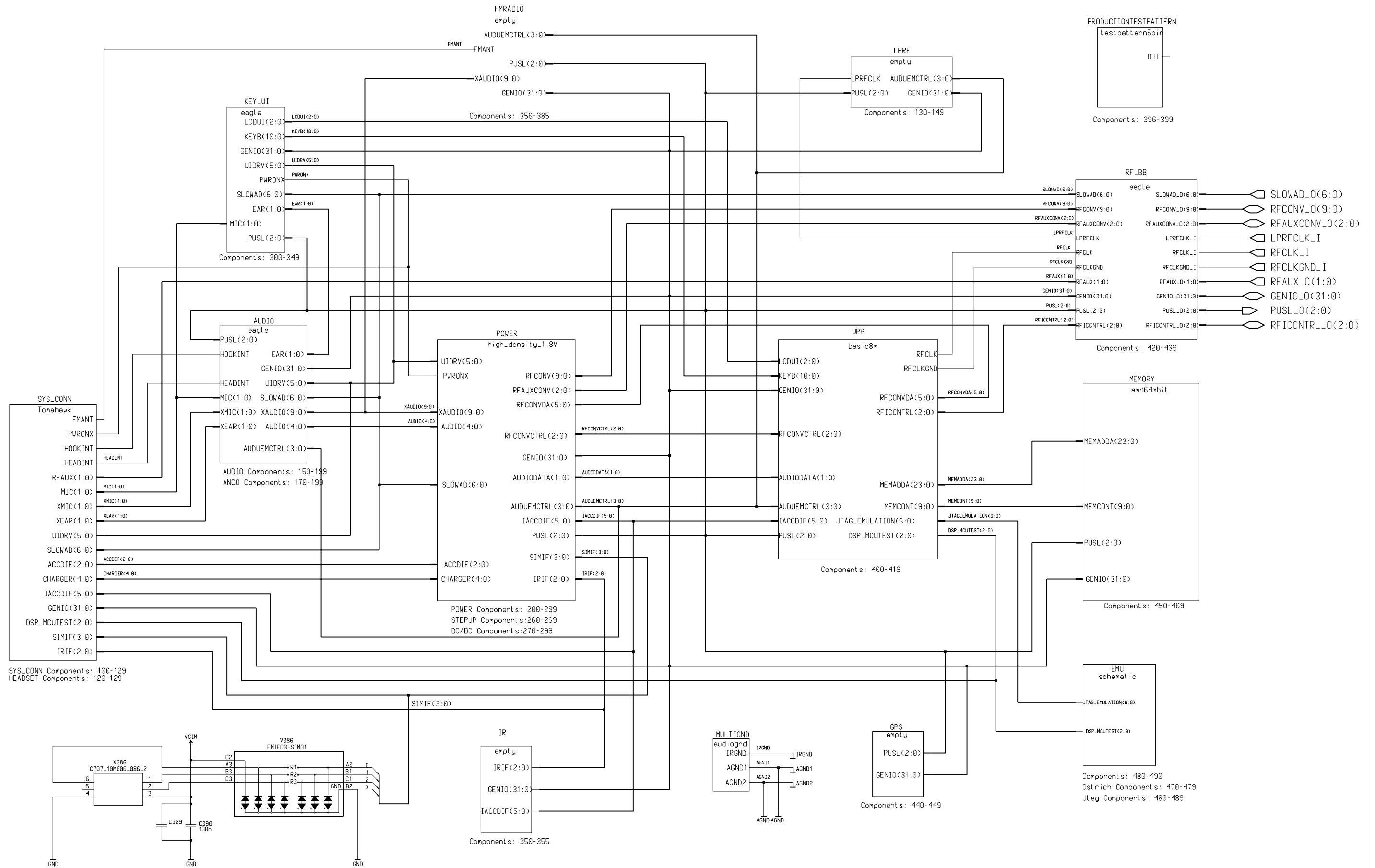

Circuit Diagram of System Connector

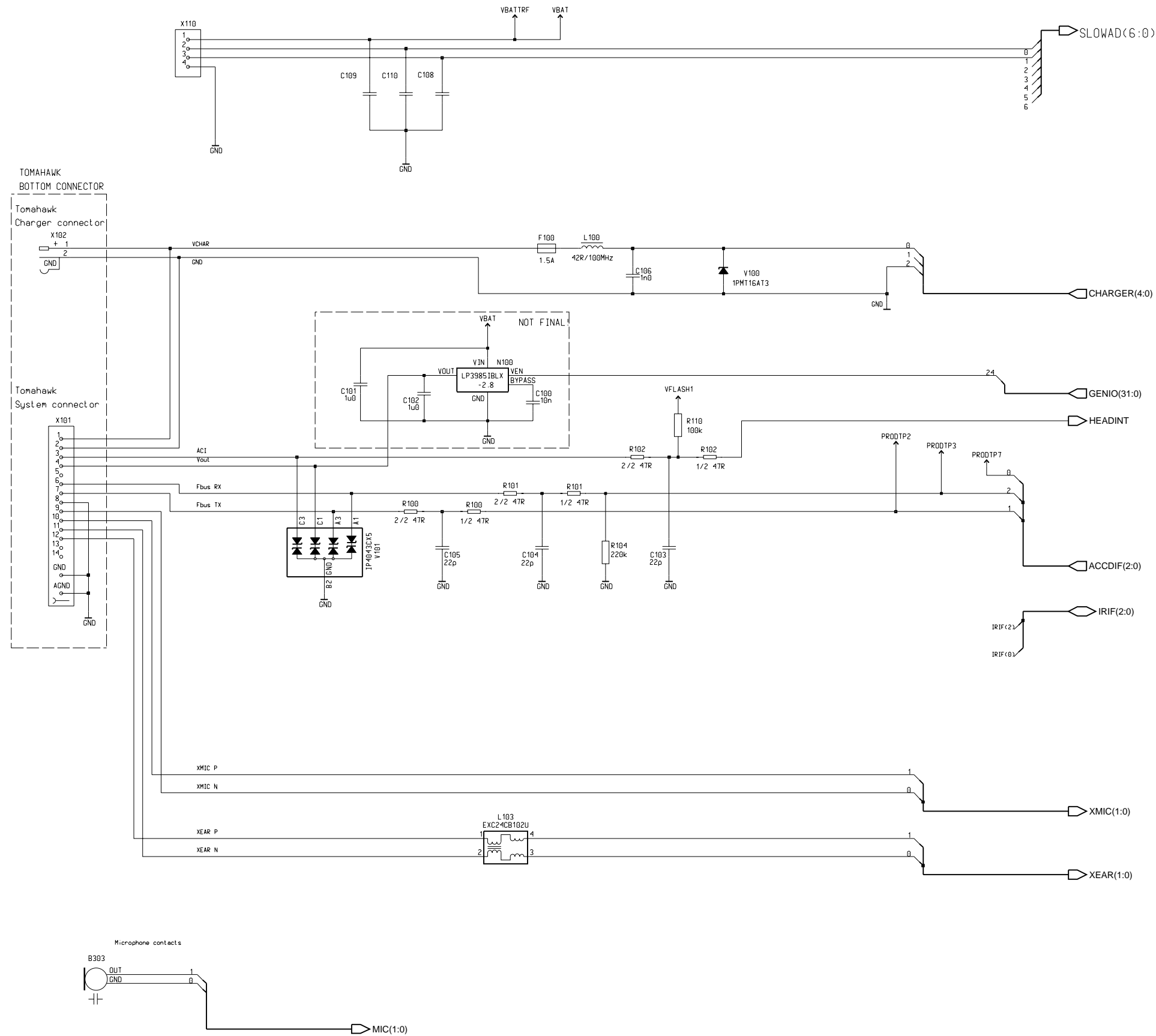

Circuit Diagram of Top Level

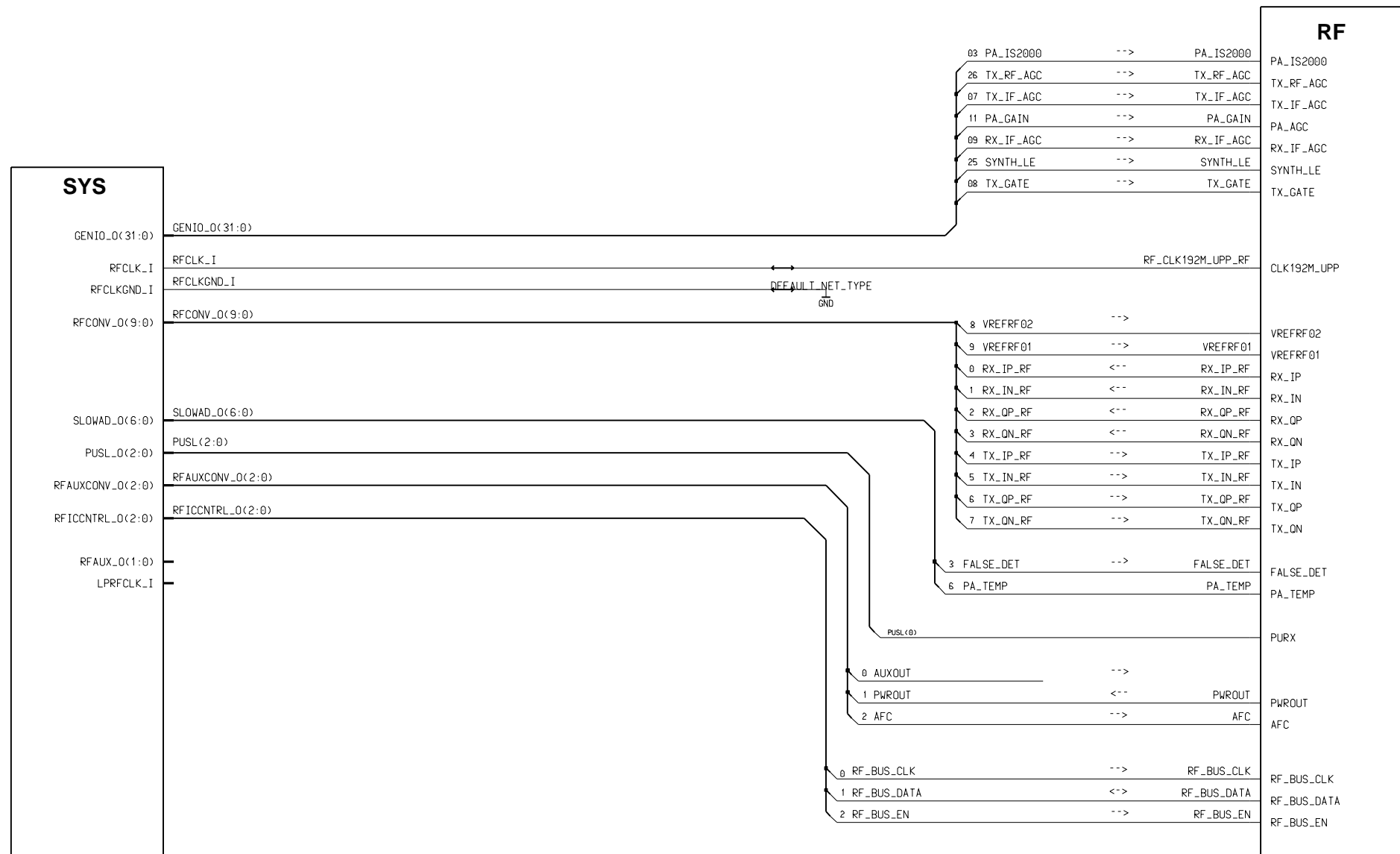

Circuit Diagram of UHF Synthesizer

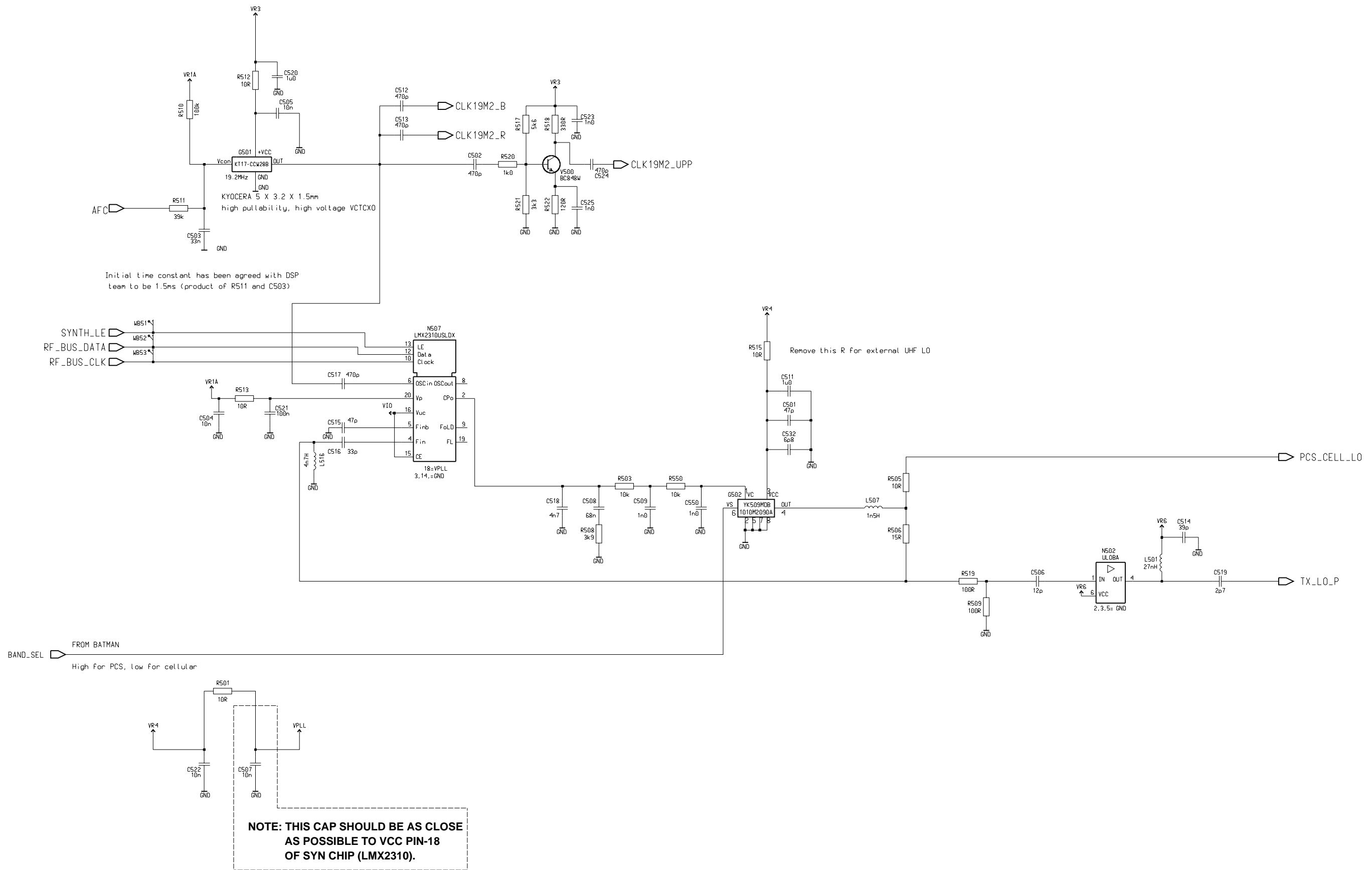

Circuit Diagram of DCT4 UPP

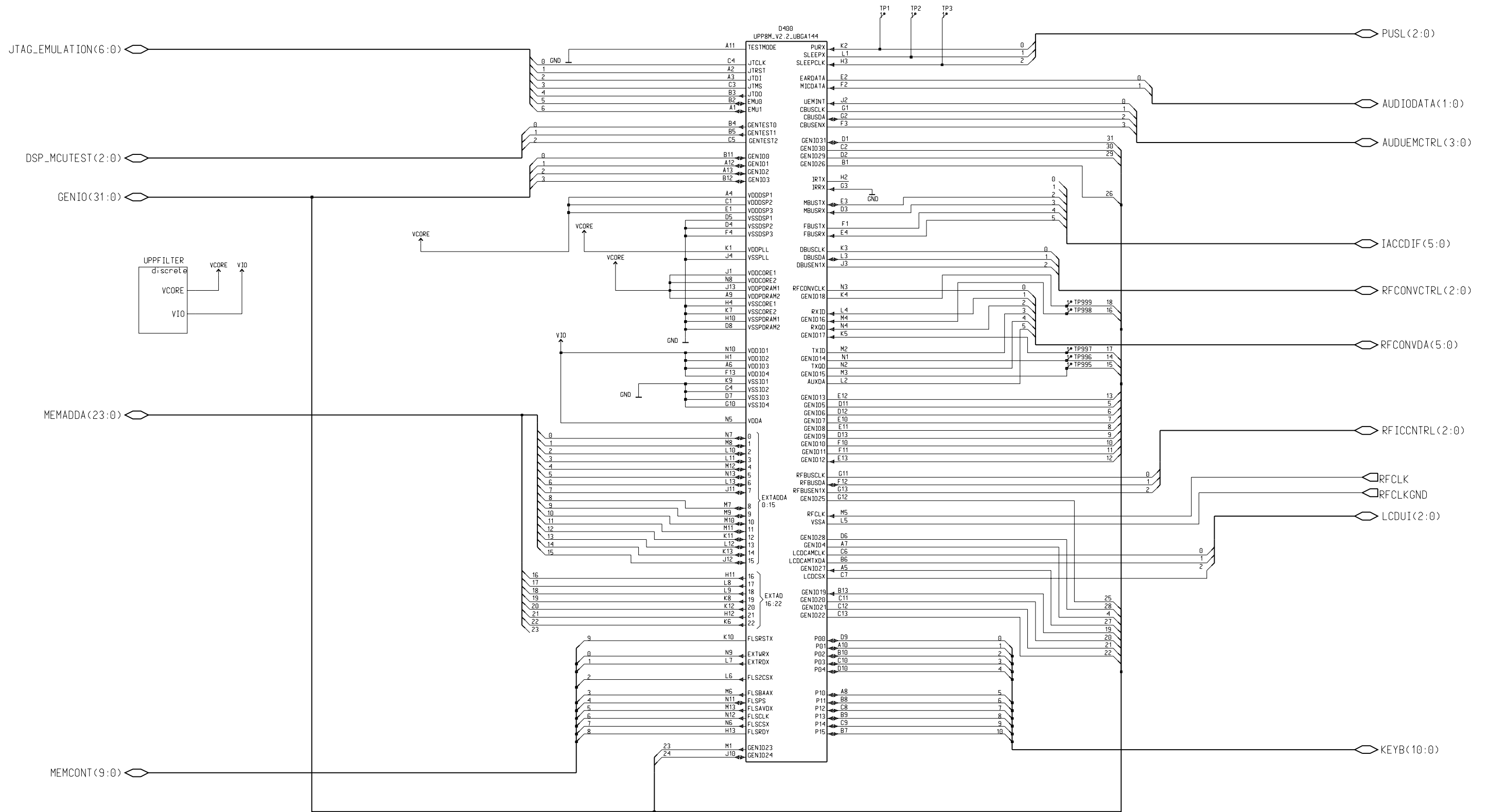

User Interface

- SLOWAD(6:0) >
- MIC(1:0) >
- PUSL(2:0) >

