

Bluetooth

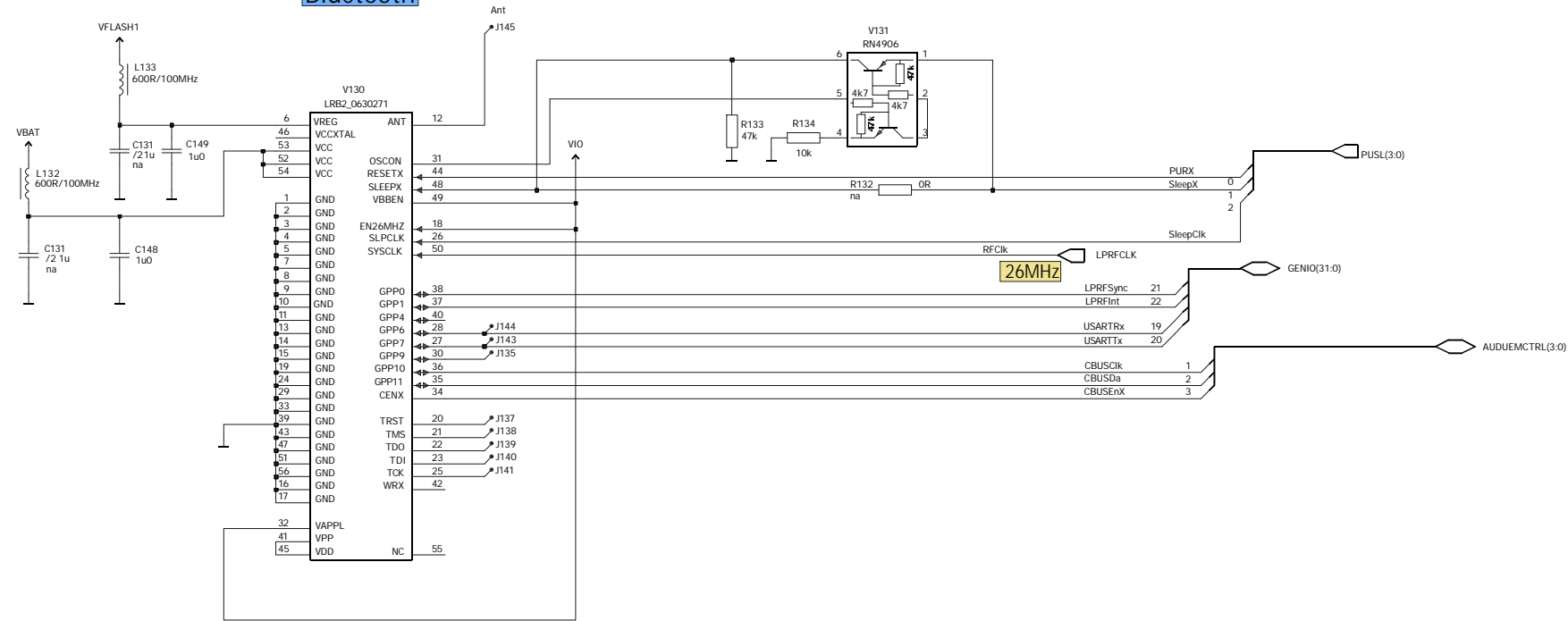

IRDA

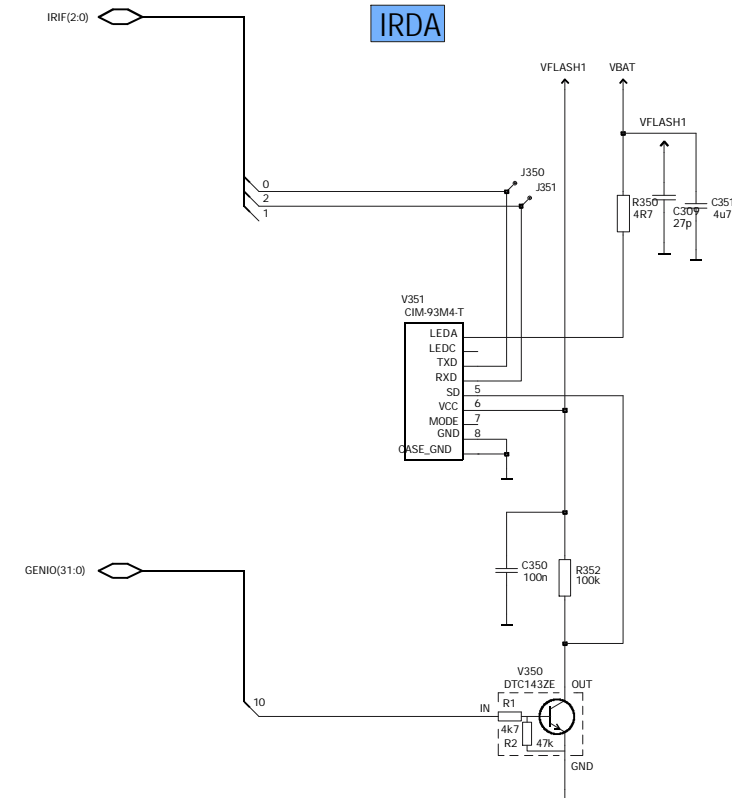

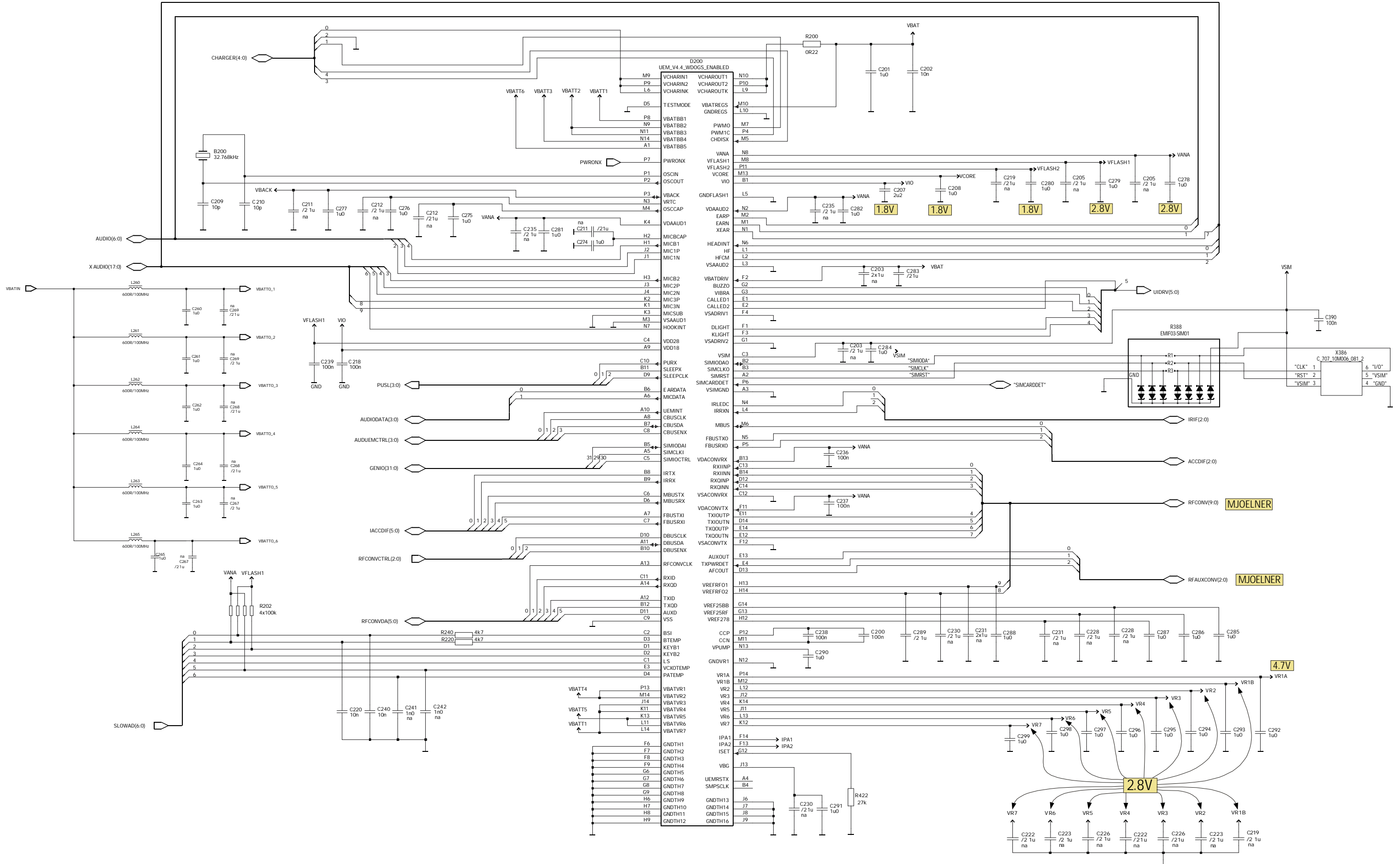

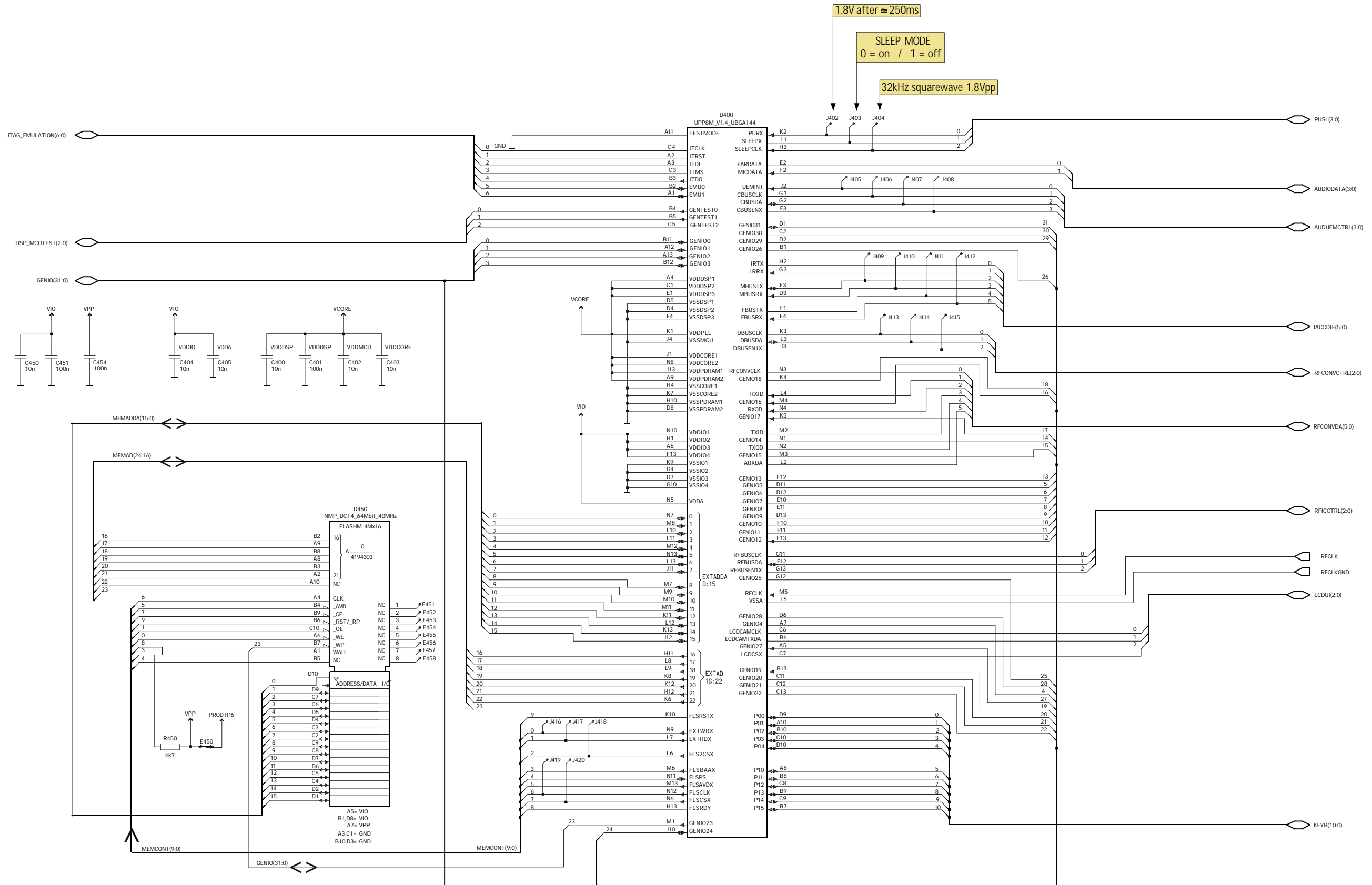

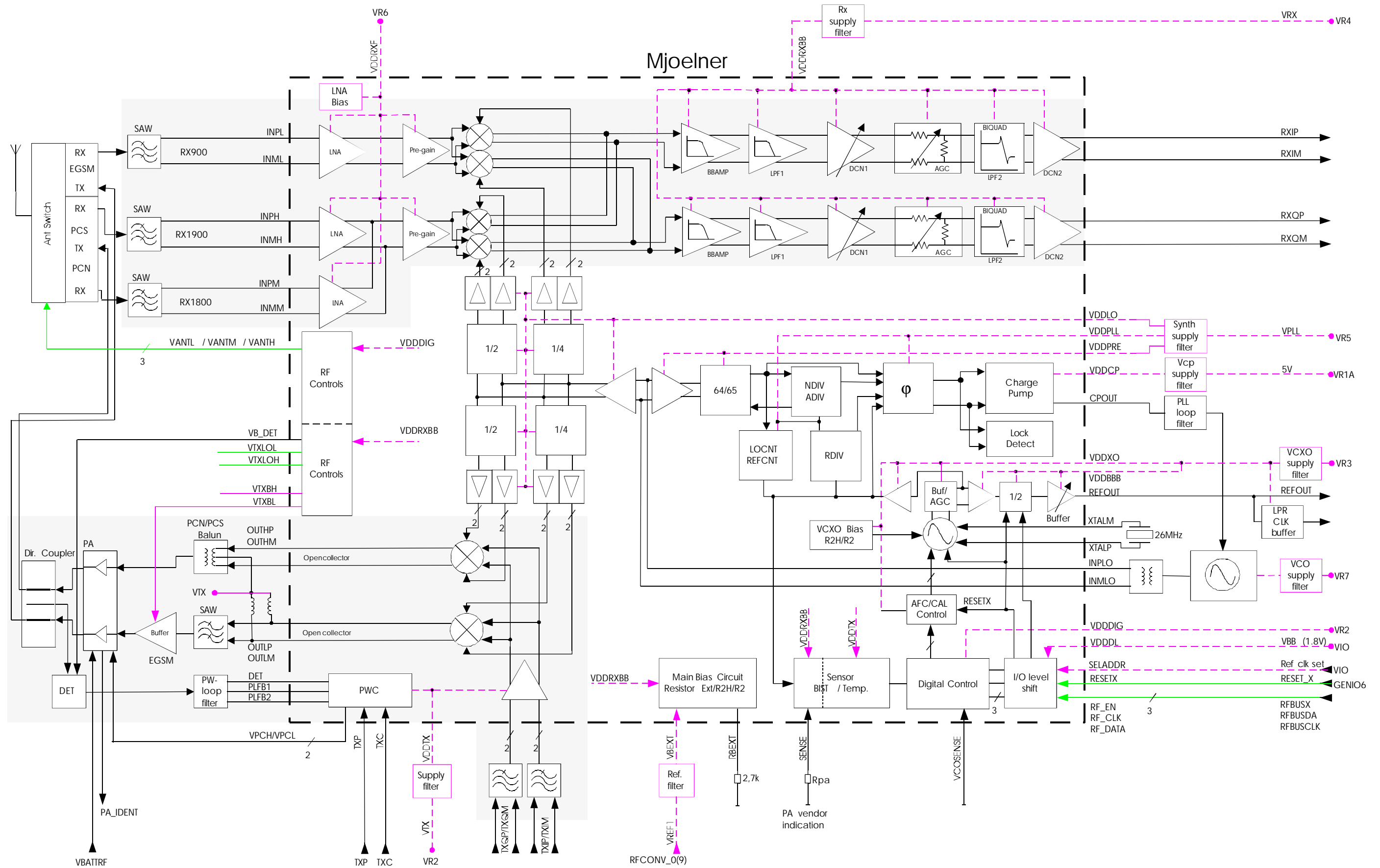

Band	Channel	RX	VCO	TX	VCO
GSM 900	37	942,4MHz	3769,6MHz	897,4MHz	3580,6MHz
GSM 1800	700	1842,8MHz	3685,6MHz	1747,8MHz	3495,6MHz
GSM 1900	661	1960MHz	3920MHz	1880MHz	3760MHz

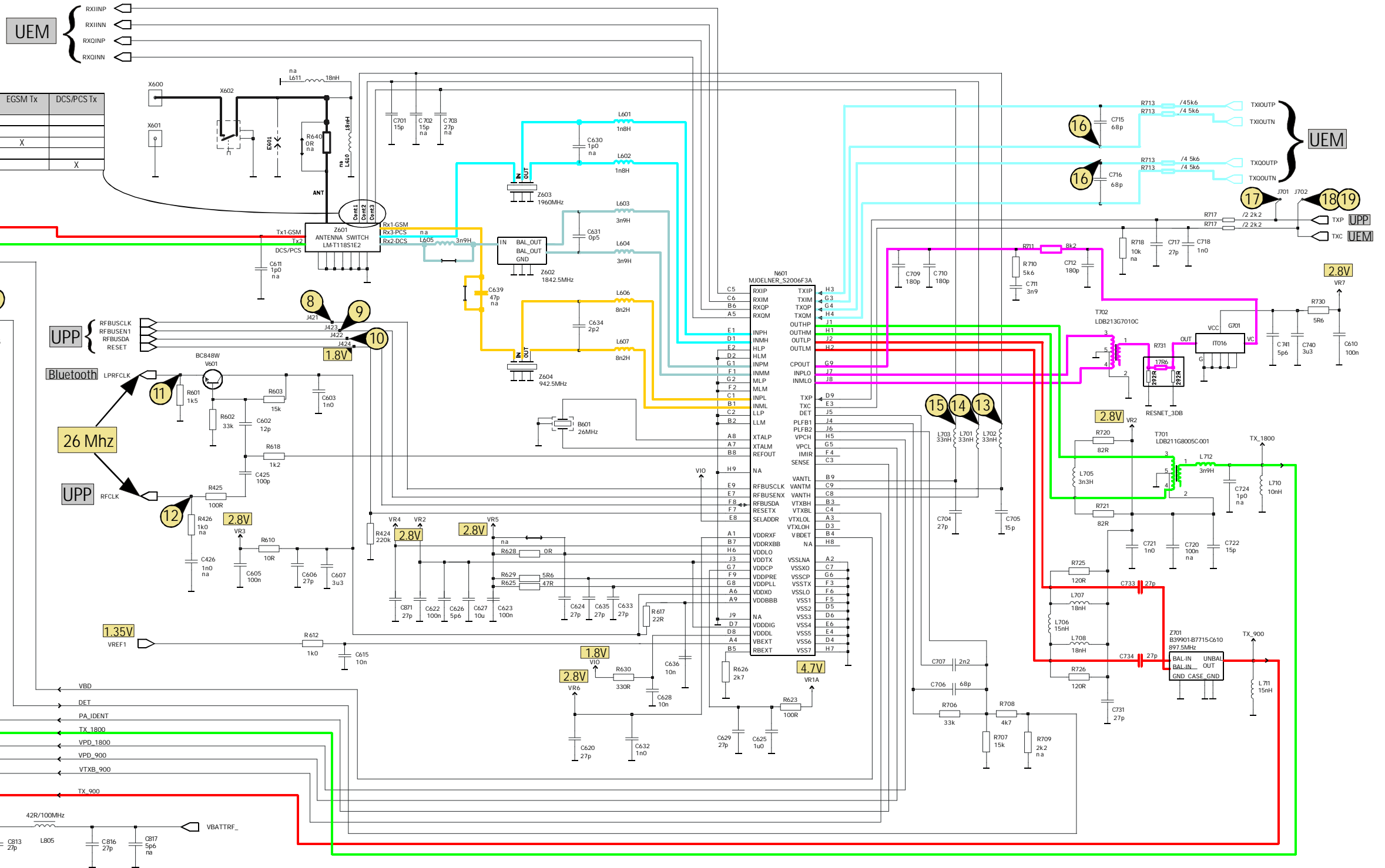

CONT1 [Volt]	CONT2 [Volt]	CONT3 [Volt]	EGSM Rx	DCS Rx	PCS Rx	EGSM Tx	DCS/PCS Tx
0	0	0	X	X			
0	0	2.7			X	X	
0	2.7	0					X
2.7	0	0					

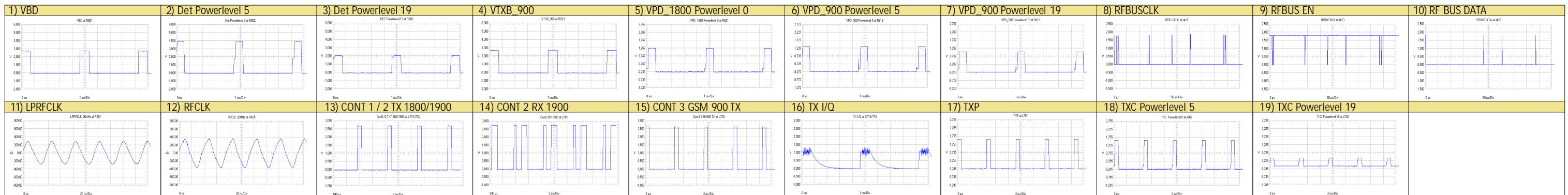

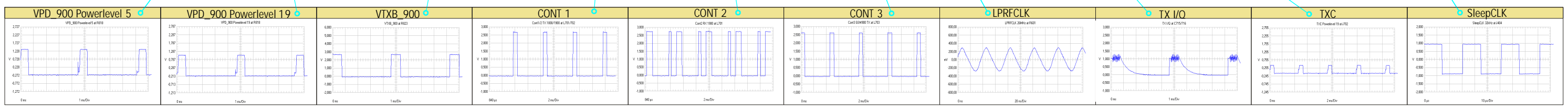
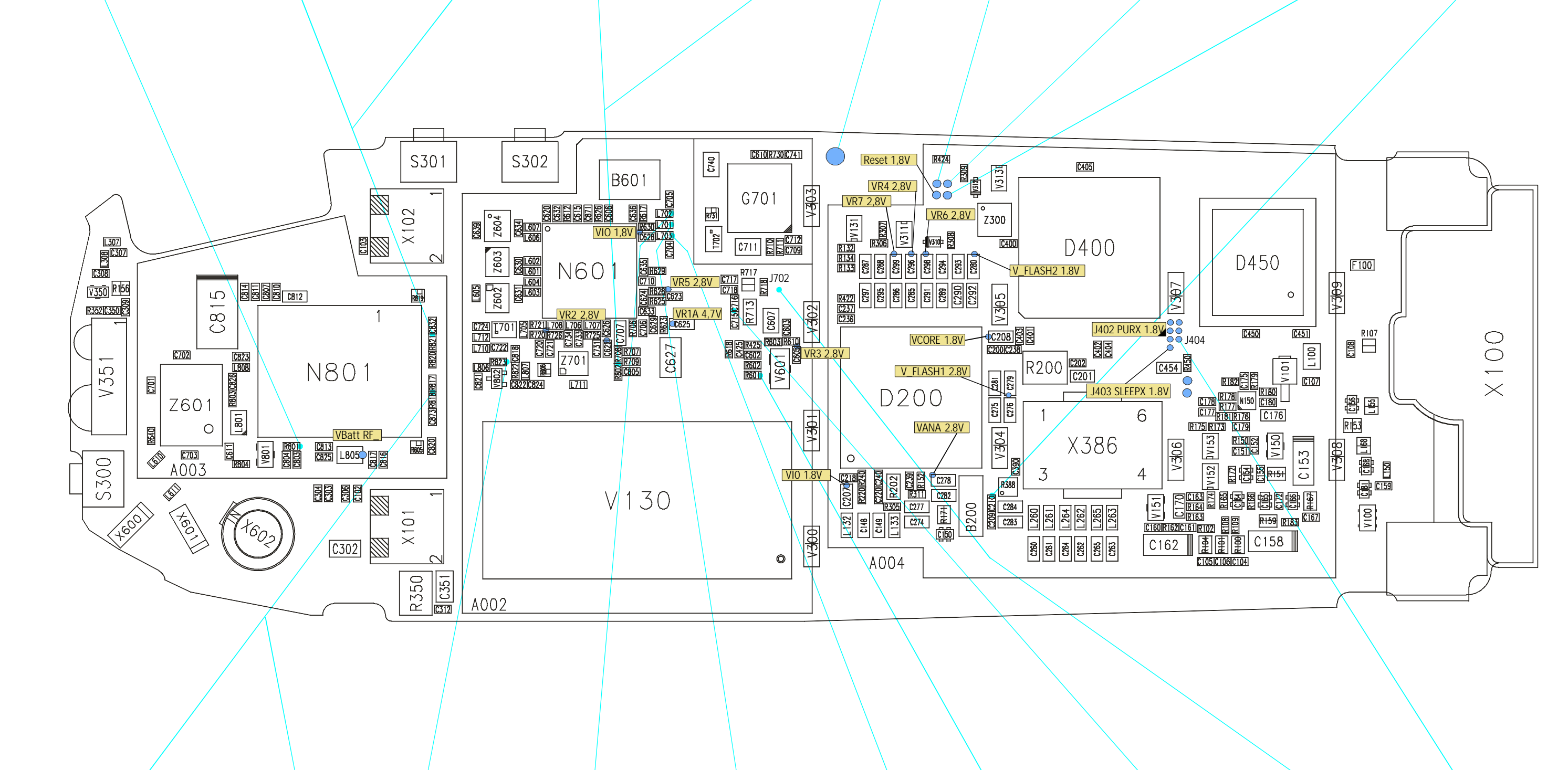
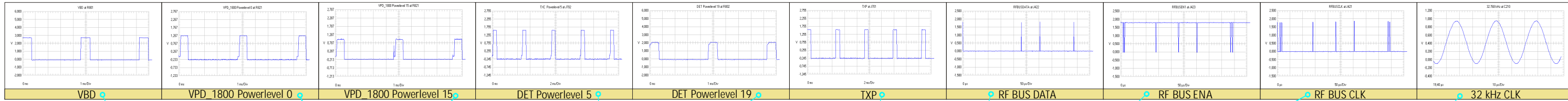

B200 - P3	C160 - S2	C202 - R5	C276 - Q4	C296 - O7	C405 - R8	C628 - K7	C712 - M7	C812 - E6	F100 - W7	L605 - H6	N150 - U4	R163 - T2	R220 - N3	R617 - J8	R725 - J6	T701 - H6	V310 - O7	Z604 - H7
B601 - J8	C161 - T2	C207 - N3	C277 - O3	C297 - N6	C425 - L5	C629 - K6	C715 - L6	C813 - E4	G701 - L8	L606 - I7	N601 - J7	R164 - T3	R240 - N3	R618 - L5	R726 - I6	T702 - L7	V311 - O7	Z701 - I5
C102 - F3	C162 - S2	C208 - O6	C278 - P3	C298 - O7	C450 - U6	C630 - H7	C716 - L6	C814 - D6	L100 - V5	L607 - I7	N801 - E5	R165 - T3	R305 - O3	R623 - K6	R730 - M9	V100 - W2	V312 - P8	
C103 - F7	C163 - T3	C209 - P2	C279 - Q5	C299 - O7	C451 - V6	C631 - H6	C717 - L7	C815 - C6	L132 - N2	L610 - B3	R100 - U2	R166 - U3	R306 - O7	R625 - K6	R731 - L8	V101 - U5	V313 - Q8	
C104 - U2	C164 - U3	C210 - P3	C280 - P7	C302 - E2	C454 - T5	C632 - I8	C718 - L6	C816 - F3	L133 - O2	L611 - B3	R101 - T2	R167 - V3	R307 - O7	R626 - J8	R801 - D4	V130 - J3	V350 - A6	
C105 - T2	C165 - U3	C218 - N3	C281 - Q5	C303 - E3	C602 - L5	C633 - K6	C720 - I5	C817 - F3	L150 - W3	L701 - K8	R102 - T2	R171 - P3	R308 - P7	R628 - K6	R802 - J5	V131 - N7	V351 - A5	
C106 - T2	C166 - V3	C220 - O3	C282 - P3	C304 - E3	C603 - M6	C634 - H7	C721 - I5	C818 - H5	L155 - W4	L702 - K8	R104 - T2	R172 - U3	R309 - P8	R629 - K7	R803 - C5	V150 - U4	V601 - M5	
C107 - V5	C167 - V2	C236 - N6	C283 - Q2	C306 - E3	C605 - M5	C635 - J7	C722 - H5	C820 - G4	L168 - W4	L703 - K7	R107 - W5	R173 - T4	R311 - O3	R630 - K7	R804 - D3	V151 - S3	V801 - D4	
C108 - W5	C168 - W3	C237 - N6	C284 - Q3	C307 - A7	C606 - J8	C636 - J8	C724 - H6	C821 - H5	L260 - Q2	L705 - H6	R108 - T2	R174 - T3	R350 - G1	R640 - B4	R805 - G4	V152 - T3	V802 - H5	
C148 - N2	C170 - T3	C238 - Q5	C285 - O6	C308 - A7	C607 - M6	C639 - H7	C731 - J5	C822 - H5	L261 - Q2	L706 - I6	R109 - U2	R175 - T4	R352 - A6	R706 - J6	R806 - I5	V153 - T4	X100 - X5	
C149 - O2	C172 - U3	C239 - O3	C286 - O6	C309 - B6	C610 - L9	C701 - B5	C733 - I6	C823 - D5	L262 - R2	L707 - J6	R132 - N7	R176 - U4	R388 - Q3	R707 - J5	R817 - G5	V300 - M2	X101 - F2	
C150 - P2	C175 - U5	C240 - O3	C287 - N7	C312 - G1	C611 - C4	C702 - C5	C734 - I6	C824 - I5	L263 - S2	L708 - I6	R133 - N7	R177 - U4	R422 - N6	R708 - J5	R818 - G4	V301 - M4	X102 - F7	
C151 - U4	C176 - U4	C260 - Q2	C288 - O7	C350 - A6	C615 - I8	C703 - C4	C740 - L9	C825 - E4	L264 - R2	L710 - H5	R134 - N7	R178 - U5	R424 - P9	R709 - J5	R819 - G6	V302 - M6	X386 - R4	
C152 - U4	C177 - T4	C261 - Q2	C289 - P6	C351 - G1	C620 - I8	C704 - K7	C741 - M9	C826 - C5	L265 - R2	L711 - I5	R150 - U4	R179 - U5	R425 - L5	R710 - M7	R820 - G5	V303 - M8	X600 - B2	
C153 - V3	C178 - T4	C262 - R2	C290 - P6	C390 - Q3	C622 - J5	C705 - K8	C803 - E3	C832 - G6	L307 - A7	L712 - H6	R151 - U3	R180 - U5	R450 - T5	R711 - M7	R821 - G5	V304 - Q4	X601 - C2	
C154 - U3	C179 - U4	C263 - S2	C291 - O6	C400 - Q7	C623 - K6	C706 - J6	C804 - D3	C871 - J8	L308 - A7	L801 - D4	R152 - O3	R181 - T4	R601 - L5	R713 - L6	R822 - H5	V305 - Q6	X602 - D2	
C155 - U3	C180 - U4	C264 - R2	C292 - P6	C401 - Q6	C624 - J6	C707 - J6	C805 - J5	C873 - G4	L601 - I7	L805 - E4	R153 - W4	R182 - U5	R602 - L5	R717 - L6	R823 - H5	V306 - T3	Z300 - O8	
C156 - W4	C181 - W3	C265 - R2	C293 - P7	C402 - R5	C625 - K6	C709 - M7	C807 - D6	D200 - O5	L602 - I7	L806 - H5	R156 - B6	R183 - V2	R603 - M5	R718 - M6	S300 - A3	V307 - T6	Z601 - C4	
C158 - U2	C200 - O5	C274 - O2	C294 - P7	C403 - Q6	C626 - J6	C710 - K7	C810 - D6	D400 - R7	L603 - I6	L807 - H5	R159 - U2	R200 - Q5	R610 - M6	R720 - I6	S301 - G9	V308 - V3	Z602 - H6	
C159 - W3	C201 - R5	C275 - Q4	C295 - O6	C404 - R5	C627 - K5	C711 - L7	C811 - D6	D450 - U7	L604 - I7	L808 - D5	R162 - T2	R202 - O3	R612 - I8	R721 - I6	S302 - I9	V309 - V6	Z603 - H7	

