

SERVICE MANUAL  
Level 1&2

# NOKIA C1-02

## RM-643 / RM-644



### Transceiver characteristics

#### Band

RM-643:  
EGSM 900/1800  
RM-644:  
EGSM 850/1900

#### Display

128x160 TFT display

#### Operating System

Series 40

#### Connections:

Bluetooth  
3.5mm jack  
Micro USB

#### Transceiver with BL-5C / BL-5CB battery pack

Talk time	Standby
<b>BL-5C:</b> Ectel: 5.5 h Best: 20 h	<b>BL-5C:</b> Ectel: 593 h Best: 744 h
<b>BL-5CB:</b> Ectel: 4 h Best: 15 h	<b>BL-5CB:</b> Ectel: 465 h Best: 583 h

#### Note:

Talk times are dependent on network parameters and phone settings

## Table of contents

1. COPYRIGHT .....	4
2. WARNINGS AND CAUTIONS.....	5
2.1 WARNINGS.....	5
2.2 CAUTIONS.....	5
3. ESD PROTECTION .....	6
4. CARE AND MAINTENANCE .....	7
5. BATTERY INFORMATION.....	8
6. EXPLODED VIEW.....	9
7. SERVICE DEVICES .....	10
8. SOFTWARE UPDATE.....	11
9. DISASSEMBLY INSTRUCTIONS .....	12
10. ASSEMBLY HINTS .....	18
11. SOLDER COMPONENTS.....	19

CHANGE HISTORY

Status	Version No.	Date	Comments
Approved	1.0	12.11.2010	First approved version

The purpose of this document is to help NOKIA service levels 1 and 2 workshop technicians to carry out service to NOKIA products. This Service Manual is to be used only by authorized NOKIA service suppliers, and the content of it is confidential. Please note that NOKIA provides also other guidance documents (e.g. Service Bulletins) for service suppliers, follow these regularly and comply with the given instructions.

While every endeavor has been made to ensure the accuracy of this document, some errors may exist. If you find any errors or if you have further suggestions, please notify NOKIA using the address below:

**Nokia Care Academy**  
[service.manuals@nokia.com](mailto:service.manuals@nokia.com)

Please keep in mind also that this documentation is continuously being updated and modified, so watch always out for the newest version.

## 1. COPYRIGHT

Copyright © 2010 Nokia. All rights reserved.

Reproduction, transfer, distribution or storage of part or all of the contents in this document in any form without the prior written permission of Nokia is prohibited.

Nokia, Nokia Connecting People, and Nokia X and Y are trademarks or registered trademarks of Nokia Corporation. Other product and company names mentioned herein may be trademarks or tradenames of their respective owners.

Nokia operates a policy of continuous development. Nokia reserves the right to make changes and improvements to any of the products described in this document without prior notice.

Under no circumstances shall Nokia be responsible for any loss of data or income or any special, incidental, consequential or indirect damages howsoever caused.

The contents of this document are provided “as is”. Except as required by applicable law, no warranties of any kind, either express or implied, including, but not limited to, the implied warranties of merchantability and fitness for a particular purpose, are made in relation to the accuracy, reliability or contents of this document. Nokia reserves the right to revise this document or withdraw it at any time without prior notice.

The availability of particular products may vary by region.

### **IMPORTANT**

This document is intended for use by qualified service personnel only.

## 2. WARNINGS AND CAUTIONS

Please refer to the phone's user guide for instructions relating to operation, care and maintenance including important safety information. Note also the following:

### 2.1 Warnings

1. CARE MUST BE TAKEN ON INSTALLATION IN VEHICLES FITTED WITH ELECTRONIC ENGINE MANAGEMENT SYSTEMS AND ANTI-SKID BRAKING SYSTEMS. UNDER CERTAIN FAULT CONDITIONS, EMITTED RF ENERGY CAN AFFECT THEIR OPERATION. IF NECESSARY, CONSULT THE VEHICLE DEALER/MANUFACTURER TO DETERMINE THE IMMUNITY OF VEHICLE ELECTRONIC SYSTEMS TO RF ENERGY.
2. THE HANDPORTABLE TELEPHONE MUST NOT BE OPERATED IN AREAS LIKELY TO CONTAIN POTENTIALLY EXPLOSIVE ATMOSPHERES, EG PETROL STATIONS (SERVICE STATIONS), BLASTING AREAS ETC.
3. OPERATION OF ANY RADIO TRANSMITTING EQUIPMENT, INCLUDING CELLULAR TELEPHONES, MAY INTERFERE WITH THE FUNCTIONALITY OF INADEQUATELY PROTECTED MEDICAL DEVICES. CONSULT A PHYSICIAN OR THE MANUFACTURER OF THE MEDICAL DEVICE IF YOU HAVE ANY QUESTIONS. OTHER ELECTRONIC EQUIPMENT MAY ALSO BE SUBJECT TO INTERFERENCE.

### 2.2 Cautions

1. Servicing and alignment must be undertaken by qualified personnel only.
2. Ensure all work is carried out at an anti-static workstation and that an anti-static wrist strap is worn.
3. Use only approved components as specified in the parts list.
4. Ensure all components, modules screws and insulators are correctly re-fitted after servicing and alignment.
5. Ensure all cables and wires are repositioned correctly

### 3. ESD PROTECTION

Nokia requires that service points have sufficient ESD protection (against static electricity) when servicing the phone.



Any product of which the covers are removed must be handled with ESD protection. The SIM card can be replaced without ESD protection if the product is otherwise ready for use.

To replace the covers ESD protection must be applied.

All electronic parts of the product are susceptible to ESD. Resistors, too, can be damaged by static electricity discharge.

All ESD sensitive parts must be packed in metallized protective bags during shipping and handling outside any ESD Protected Area (EPA).

Every repair action involving opening the product or handling the product components must be done under ESD protection.

ESD protected spare part packages **MUST NOT** be opened/closed out of an ESD Protected Area.

For more information and local requirements about ESD protection and ESD Protected Area, contact your local Nokia After Market Services representative.

#### 4. CARE AND MAINTENANCE

This product is of superior design and craftsmanship and should be treated with care. The suggestions below will help you to fulfil any warranty obligations and to enjoy this product for many years.

- Keep the phone and all its parts and accessories out of the reach of small children.
- Keep the phone dry. Precipitation, humidity and all types of liquids or moisture can contain minerals that will corrode electronic circuits.
- Do not use or store the phone in dusty, dirty areas. Its moving parts can be damaged.
- Do not store the phone in hot areas. High temperatures can shorten the life of electronic devices, damage batteries, and warp or melt certain plastics.
- Do not store the phone in cold areas. When it warms up (to its normal temperature), moisture can form inside, which may damage electronic circuit boards.
- Do not drop, knock or shake the phone. Rough handling can break internal circuit boards.
- Do not use harsh chemicals, cleaning solvents, or strong detergents to clean the phone.
- Do not paint the phone. Paint can clog the moving parts and prevent proper operation.
- Use only the supplied or an approved replacement antenna. Unauthorised antennas, modifications or attachments could damage the phone and may violate regulations governing radio devices.

All of the above suggestions apply equally to the product, battery, charger or any accessory.

## 5. BATTERY INFORMATION

Note: A new battery's full performance is achieved only after two or three complete charge and discharge cycles! The battery can be charged and discharged hundreds of times but it will eventually wear out.

When the operating time (talk-time and standby time) is noticeably shorter than normal, it is time to buy a new battery. Use only batteries approved by the phone manufacturer and recharge the battery only with the chargers approved by the manufacturer.

Unplug the charger when not in use. Do not leave the battery connected to a charger for longer than a week, since overcharging may shorten its lifetime.

If left unused a fully charged battery will discharge itself over time. Temperature extremes can affect the ability of your battery to charge.

For good operation times with Ni-Cd/NiMh batteries, discharge the battery from time to time by leaving the product switched on until it turns itself off (or by using the battery discharge facility of any approved accessory available for the product).

Do not attempt to discharge the battery by any other means. Use the battery only for its intended purpose.

Never use any charger or battery which is damaged.

Do not short-circuit the battery. Accidental short-circuiting can occur when a metallic object (coin, clip or pen) causes direct connection of the + and - terminals of the battery (metal strips on the battery) for example when you carry a spare battery in your pocket or purse. Shortcircuiting the terminals may damage the battery or the connecting object.

Leaving the battery in hot or cold places, such as in a closed car in summer or winter conditions, will reduce the capacity and lifetime of the battery. Always try to keep the battery between 15°C and 25°C (59°F and 77°F).

A phone with a hot or cold battery may temporarily not work, even when the battery is fully charged. Batteries' performance is particularly limited in temperatures well below freezing.

Do not dispose batteries in a fire! Dispose of batteries according to local regulations (e.g. recycling).

Do not dispose as household waste.



## 6. EXPLODED VIEW

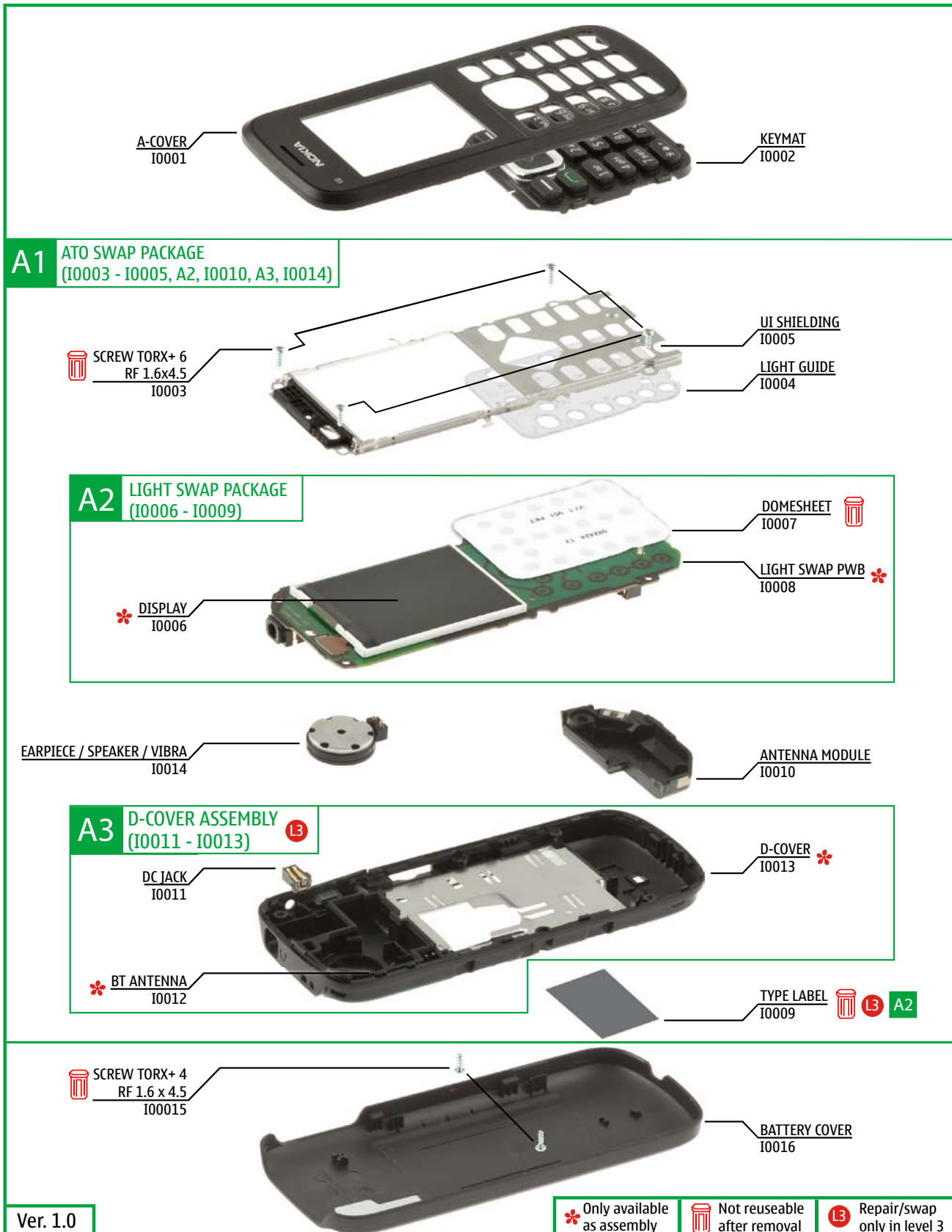

## 7. SERVICE DEVICES

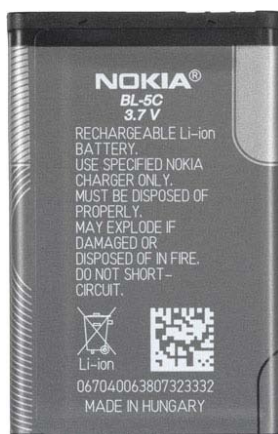

BL-5C / BL-5CB Battery



CA-101 Service Cable



AC-3 / AC-8C Travel Charger



### **Nokia Standard Toolkit (v2)**

For more information, refer to the Service Bulletin (SB-011) on Nokia Online. Supplier or manufacturer contacts for tool re-order can be found in "Recommended service equipment" document on Nokia Online.

## 8. SOFTWARE UPDATE

### Flash concept (Point of Sale)

Please check always for the latest version of flash software, which is available on Nokia Online.

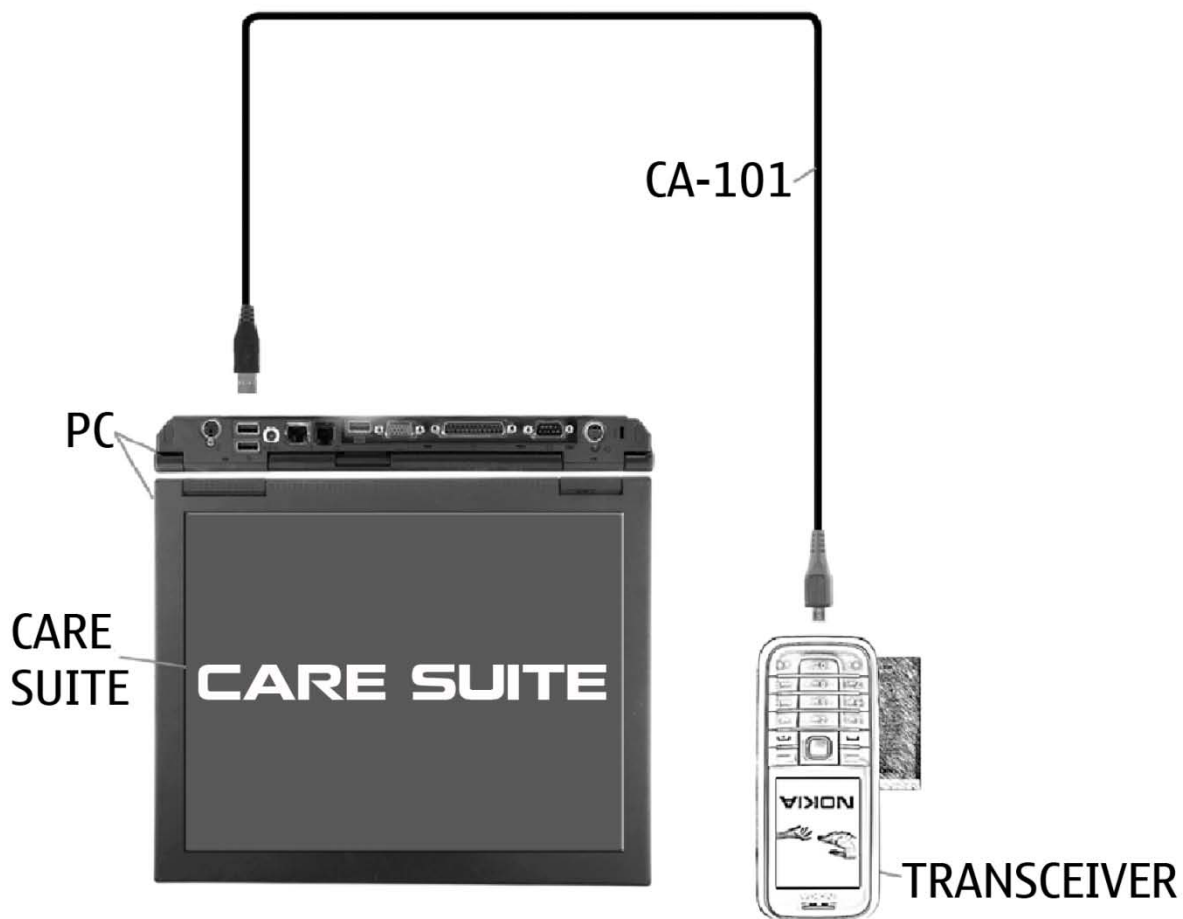

## 9. DISASSEMBLY INSTRUCTIONS



1) Nokia C1-02 disassembly.



2) You must use the Nokia Standard Toolkit version 2. You will also need the DC plug.



3) Protect the A-COVER with the protective film.



4) Open the BATTERY COVER by using the release notch.



5) Remove the BATTERY COVER.



6) Unscrew the two Torx+ size 4 screws. Do not use them again. Discard them.



7) Release the A-COVER side from the D-COVER by sliding the SRT-6 to direction shown. Be careful not to damage the shown pin.



8) Release the other side of the A-COVER from the D-COVER by sliding the SRT-6 to direction shown.



9) Remove the A-COVER.



10) Protect the DISPLAY with the protective film.

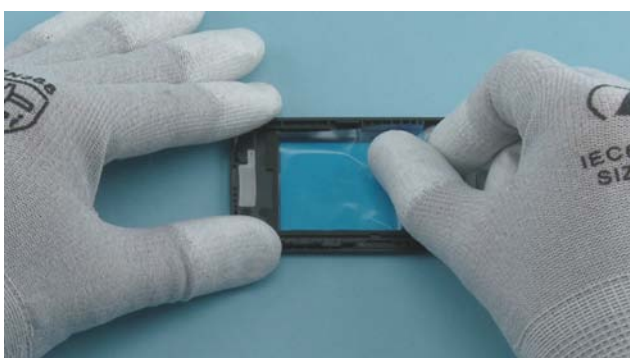

11) Protect the other side of the A-COVER with the protective film.



12) Push down to release the KEYMAT.



13) Remove the KEYMAT.



14) Unscrew the four Torx+ size 6 screws. Do not use them again. Discard them.



15) Open the USB DOOR.



16) Use the SS-93 to release the shown side of the ENGINE BOARD.

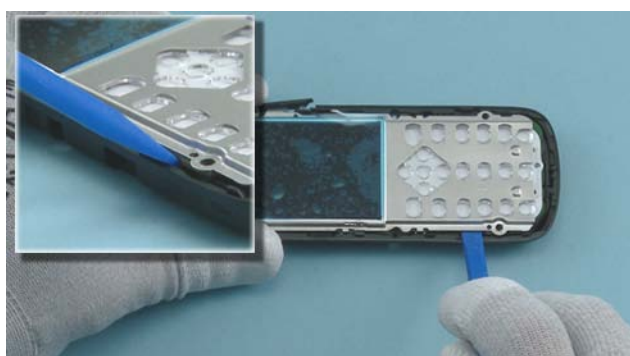

17) Release also the other side with the SS-93.

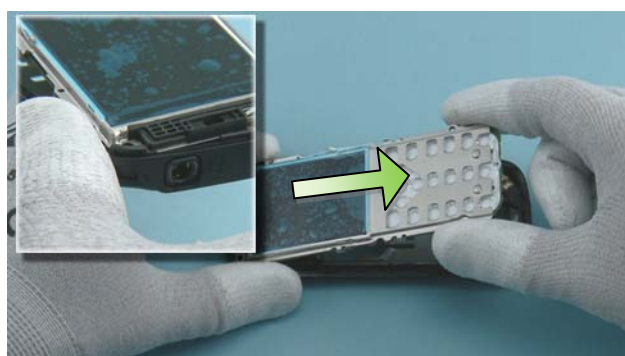

18) Lift up the bottom end of the ENGINE BOARD and then pull it to direction shown. By using this procedure, the AV JACK in the top part of the device is released properly.



19) Remove the ENGINE BOARD.

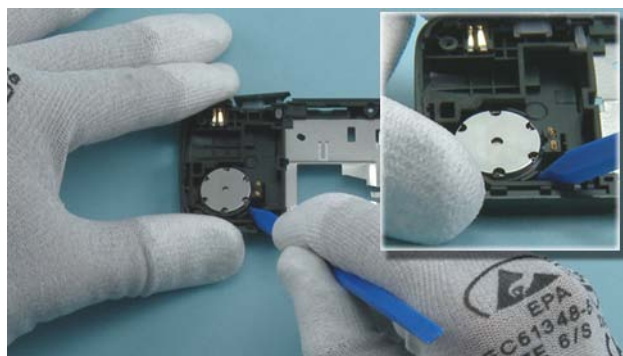

20) Use the sharp end of the SS-93 to release the EARPIECE / SPEAKER / VIBRA.

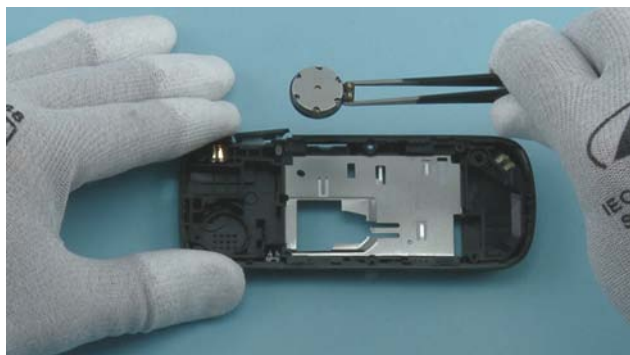

21) Remove it with the tweezers.



22) Release the DC JACK with the DC plug.



23) Remove it with the tweezers.

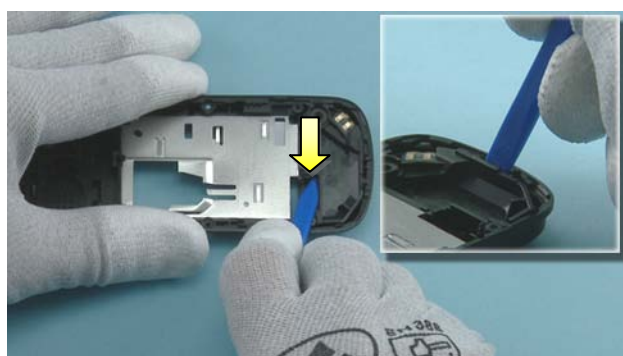

24) Use the sharp end of the SS-93 to release the ANTENNA MODULE clip and then use the flat end of the SS-93 to release the bottom end of the ANTENNA MODULE.



25) Remove the ANTENNA MODULE with the tweezers.

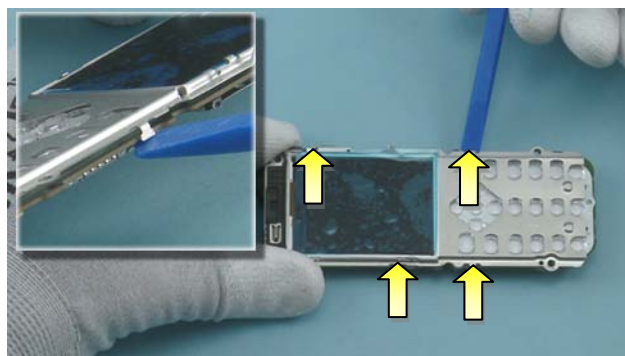

26) Release the four clips holding the UI SHIELDING with the SS-93.

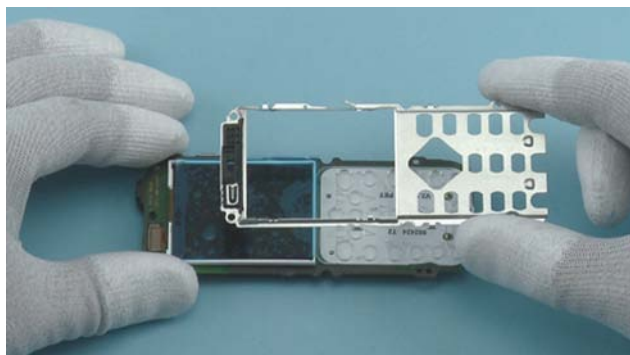

27) Remove the UI SHIELDING.

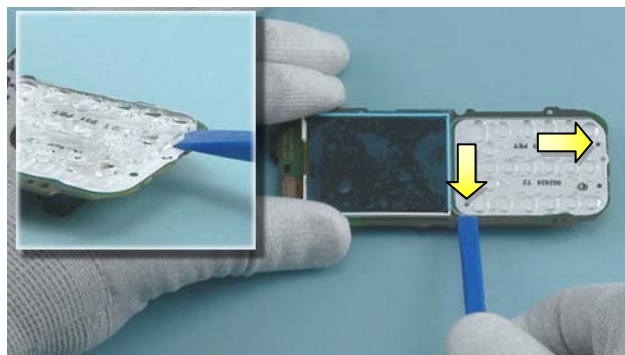

28) Release the two guiding pins holding the LIGHT GUIDE with the SS-93.



29) Remove the LIGHT GUIDE.



30) Use the dental tool to release the DOMESHEET. Be careful not to injure yourself with the sharp end of the dental tool!





31) Peel off the DOMESHEET.

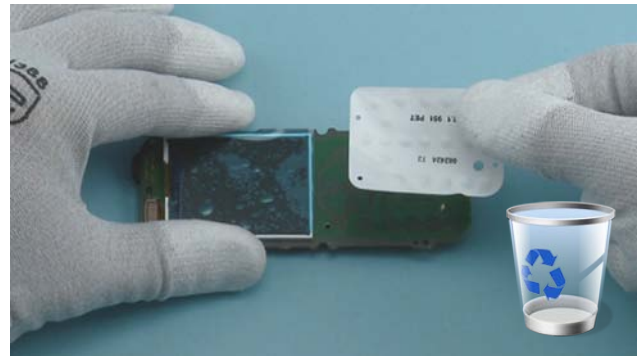

32) Remove the DOMESHEET. Do not use it again.  
Discard it.



33) The Nokia C1-02 disassembly is now complete.

-END OF DISASSEMBLY-

## 10. ASSEMBLY HINTS

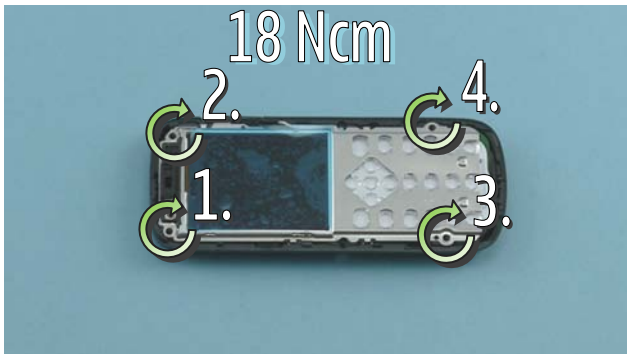

1) Tighten the TORX + size 6 screws to the torque of 18 Ncm.

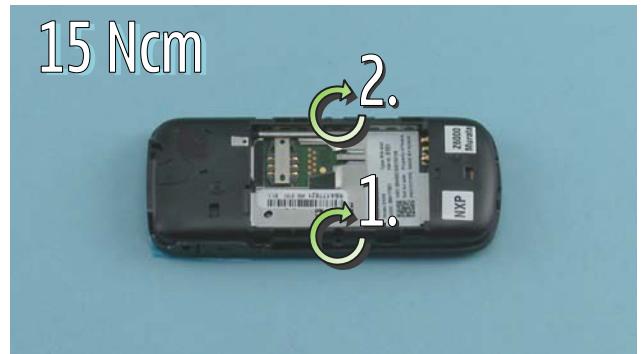

2) Tighten the TORX + size 4 screws to the torque of 15 Ncm.

### 11. SOLDER COMPONENTS

TOP

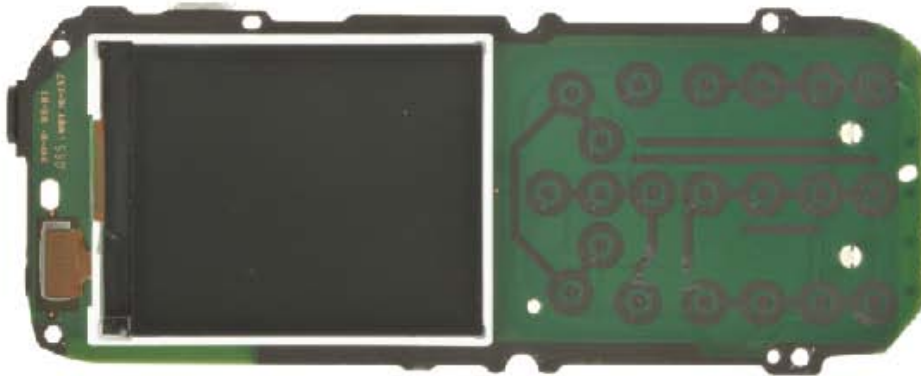

BOTTOM

