



LEVEL 2 SERVICE

FA9M0604

Trium

MARS
NEPTUNE
(DUAL BAND)



R E V I S I O N S	V E R S I O N S	A: Création B-T. LEGORGEU	09/00	Rédigé par <i>Written by</i>	Vérifié par <i>Checked by</i>	Approuvé par <i>Approved by</i>
				B. LEGORGEU	G. LEBASTARD	G. LEBASTARD

☰: Mitsubishi Electric Telecom Europe S.A.
Z.A. Le Piquet, 35370 Etrelles France

☎: +33 (0)2 99 75 71 00

📞: +33 (0)2 99 75 71 47

Version A
Date: 10/00

TABLE OF CONTENTS

TABLE OF CONTENTS	1
1 General description	1
2 Main Features of Transceiver	2
2.a Description of transceiver	2
2.b Labels	3
2.b.1 IMEI label	3
2.b.2 Label Art Plate	3
2.c SIMLatching	4
2.d Description of options	5
3 Exploded Diagram and Spare parts list	5
3.a MARS	5
3.a.1 Exploded Diagram of MARS	5
3.a.2 Spare Parts list of MARS	6
3.a.3 Assembly	6
3.b NEPTUNE	7
3.b.1 Exploded Diagram of NEPTUNE	7
3.b.2 Spare Parts list of NEPTUNE	7
3.b.3 Assembly	7
4 Test and Measurement	7
4.a Charging measurements	7
4.b E-GSM / DCS measurements	8
4.b.1 Transmitter Power and Ramp profile	8
4.b.2 Phase/ Frequency/ Time relationship	8
4.b.3 Receiver Bit Error Rate (RX sensitivity)	8
4.b.4 Handover between E-GSM 900 and DCS 1800 standards	8
4.c Operating instructions	9
4.d Buzzer, Receiver and Speaker tests	10
5 Download of software and Setting (Perso)	11
5.a IPLTrium2000	11
5.a.1 Difference between IPLTrium and IPLTrium2000	11
5.a.2 Equipment and installation of IPL Trium	12
5.a.2.1 Equipment description	12
5.a.2.2 Installation	12
5.a.2.3 To launch IPL	13
5.a.3 Description of IPLTRIUM	14
5.a.3.1 Application File	14
5.a.3.2 Loader File / Product	15
5.a.3.3 Setup Line	16
5.a.4 To use ILPTRIUM	17



5.a.4.1	Start download.	17
5.a.4.2	End of download	18
5.b	MSTools	19
5.b.1	Equipment and installation of MSTools	19
5.b.1.1	Equipment description	19
5.b.1.2	Installation	19
5.b.1.3	To launch MSTools	20
5.b.2	Description of MSTools	21
5.b.2.1	TestMode menu	21
5.b.2.1.1	Start from ...	21
5.b.2.1.2	Stop and ...	22
5.b.2.2	Mobile menu	23
5.b.2.2.1	Download personification	23
5.b.2.2.2	Initialization data users	24
5.b.2.2.3	Mobile identification / How to print labels	25
5.b.2.3	Other menu	26
6	Codes	27
6.a	TestMode	27
6.b	Software version	27
6.c	Software and Perso version	27
7	Operator Debugging	28
8	PERSONNAL NOTES	29

1 General description

The handportable cellular telephone described here is designed for use in a E-GSM/DCS network. This phone operates and complies with the ETSI GSM phase 2 specifications.

Standard kit includes following items:

- Transceiver (unretractable antenna type)
- Battery pack 800 mAh (NiMH type).
Reference : FK8B000110
- AC/DC Adapter for battery rapid charging

MODEL	MARS	NEPTUNE
PICTURE		

Speech codec:

- The mobiles M5 uses a speech codec which is able to switch from Half Rate(HR) to Full Rate(FR) or to Enhanced Full Rate(EFR) according to network, the software and settings version.
- Enhanced Full rate (EFR) allows better voice quality at same rate as Full rate.
- Half rate (HR) is coding on 6.5 kbytes/sec (1/2 Full rate). The network may put two customers on one timeslot. Each customer will use this timeslot every two frames.

Main features:

- 150 hours idle time and 3 hours conversation time
- Easy user operation with two soft keys
- Full dots graphic LCD display
- Active Flip (Neptune)
- Fixed antenna
- Hand free inside
- WAP 1.1 over CSD¹
- Data/FAX transmission capability with DATA CONTACT kit option
- SMS/Phone book control capability with DATA CONTACT kit option
- More than 8 languages display and short messaging

¹ Circuit Switch Data

2 Main Features of Transceiver

2.a Description of transceiver

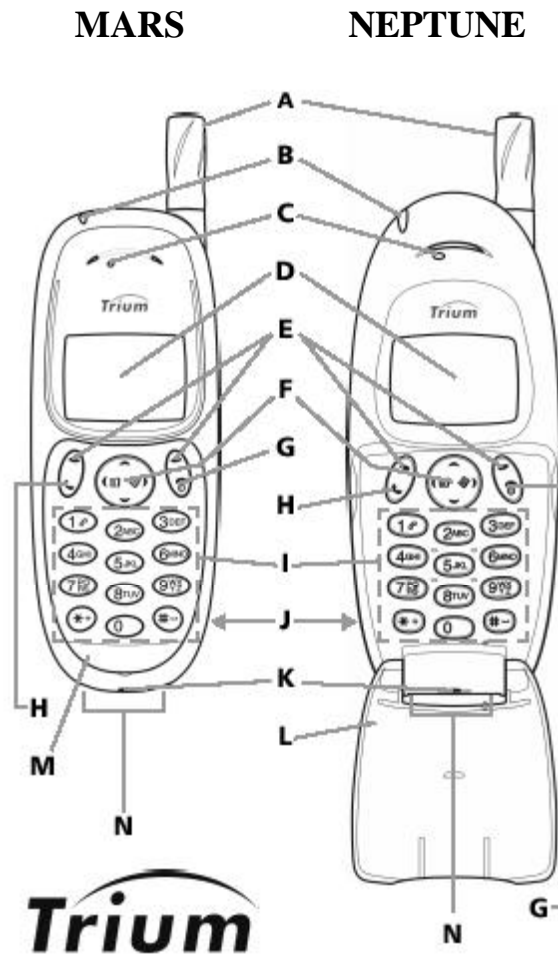

A	Antenna	H	Call/Send key: press to make or answer a call
B	LED: call and battery charge indicator	I	Alphanumeric keys: enters numbers, characters and punctuation marks
C	Earpiece	J	Changeable battery cover (at the back of the phone)
D	Graphic display: telephone numbers, menus, messages,... are displayed here	K	Microphone
E	Programmable softkeys or selection keys: perform the functions indicated by the text above them	L	Neptune changeable flip
F	Cursor indicator: navigates around the memories and menus	M	Mars changeable front cover
G	On/Off, End key: hold down to turn on or off the phone. Press to end a call or return to stand by display	N	Headset, accessories and AC/DC charger socket

2.b Labels

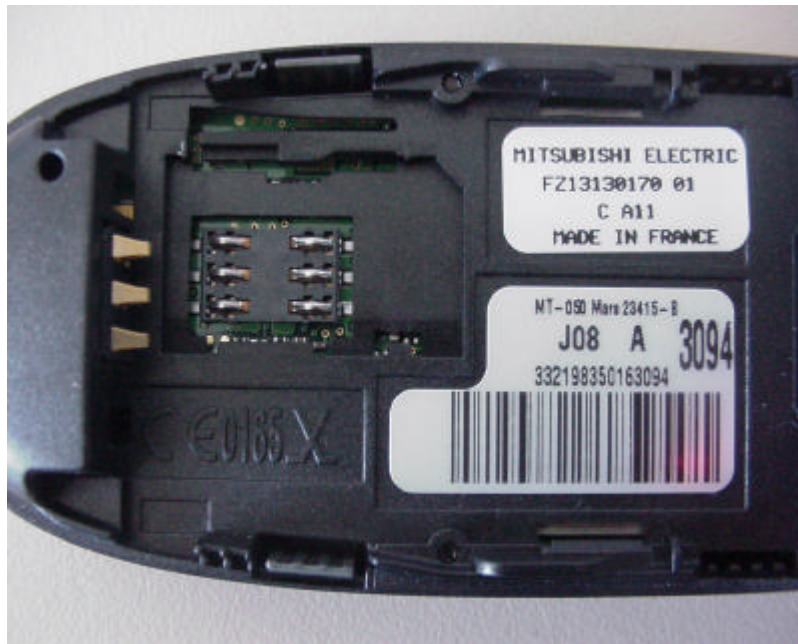

2.b.1 IMEI² label

The IMEI label is stuck on the rear case of the terminal. The IMEI is held in the logic circuitry of the main board itself. If the main board is changed then the IMEI will change.

IMEI label shows:

- Kit designation: MT-050 Mars
- Latch: 23415-B see 2.c. *SIM latching*
- Date code: the 3 digits indicate the date of shipment from factory

stands for August
08
J
stands for the year 2000

- PCA version: A
- Last four digits of IMEI number: 3094
- IMEI number: the 15 digits is written above the bar code

Production site
Checksum
332198
35
016309
4
Typical Approval Code.
Sequential number.
Linked with the type of the mobile
Linked with the mobile

2.b.2 Label Art Plate

The Label Art Plate identifies the type of assembly and test the mobile has been through.

- Name of the company: Mitsubishi electric
- Article code of the terminal: FZ13130170
- Alternative: 01
- Assembly version: C
- Production module: A11

² International Mobile Equipment Identity

2.c SIMLatching

SIM Lock consists in restricting the use of the terminal to a family of SIM cards. For the SIM Lock, three main information are used. These information are read from data fields in the SIM card.

1. IMSI (International Mobile Subscriber Identity), 15 Digits:

MCC = **M**obile **C**ountry **C**ode 3 digits (ex: 208 for France)

MNC = **M**obile **N**etwork **C**ode 2 digits (ex: 01 for France Telecom service provider)

NS = **N**etwork **S**ubset 2 digits

	MNC	Indifferent serial number
208	01	55
12312312		
MCC	NS	

2. **GID1 (Group Identifier 1)**

This data field can contain digits or letters which identify a family of SIM

Ex: XX for a type for of prepaid SIM card of Service provider 01.

3. **GID2 (Group Identifier 2)**

Same as GID1 to identify a sub family of SIM.

Then, from this information, we have 5 types of latch:

Type	IMSI				GID1	GID2	Ex:
	MCC	MNC	NS	8 Other			
Network Level NCK ³	208	01	–	–	–	–	Only the cards 208 01 are able to operate the phone (France-France Telecom)
Network Subset Level NSCK ⁴	208	01	55	–	–	–	Only the SIM cards with an IMSI starting with 208 01 55 are able to operate the phone (France-France Telecom-55-xxxxxxx)
Service Provider Level SPCK ⁵	208	01	–	–	XX	–	Only the SIM cards 208 01 of the service provider (with XX stored in GID1 field) will operate the mobile type d'abonn
Corporate Provider CPCK ⁶	208	01	–	–	–	XX	Same with GID2
IMSI level PCK	208	01	55	1234 5678	–	–	Only the IMSI card corresponding to the correct IMSI will operate the mobile

General information :

To lock /unlock a mobile, you need 8 digits password for each level concerned, and each mobile (one set of passwords for one IMEI). You have only 10 attempts to correctly unlock a mobile. After 10 unsuccessful attempt, the mobile is permanently blocked.

To enter the unlock procedure, you need to access special menus with specific access codes, given by the operator.

³ **Network Control Key**

⁴ **Network Subset Control Key**

⁵ **Service Provider Control Key**

⁶ **Corporate Provider Control Key**

2.d Description of options

Some of the mobile from Mars and Neptune family are to be defined.

Model	SAP KIT designation	Colour				Option
		Cover	Case	cover battery	Front panel	
MArs	KIT M5 MA WAP GENERIC					WAP
MArs	KIT M5 MA BI BI BLI SIC	Black Iron	Black Iron	Black Iron	Silver Cloud	WAP
MArs	KIT M5 MA BI BI SIC SIC	Black Iron	Black Iron	Silver Cloud	Silver Cloud	WAP
MArs	KIT M5 MA IG BI BLI SIC	Ivy Green	Black Iron	Black Iron	Silver Cloud	WAP
MArs	KIT M5 MA MB MB MIB MIB	Midnight Blue	Midnight Blue	Midnight Blue	Midnight Blue	WAP
MArs	KIT M5 MA MB MB MIB PE	Midnight Blue	Midnight Blue	Midnight Blue	PEarl	WAP
MArs	KIT M5 MA GPRS GENERIC					GPRS
NEptune	KIT M5 NE GENERIC					WAP
NEptune	KIT M5 NE FR FR EMG EMG	FRost	FRost	Emerald Green	EMerald Green	WAP
NEptune	KIT M5 NE FR FR PAB PAB	FRost	FRost	Parisian Blue	PARisian Blue	WAP
NEptune	KIT M5 NE DG DG DAG DAG	Dark Grey	Dark Grey	Dark Grey	Dark Grey	WAP
NEptune	KIT M5 NE MB MB MIB MIB	Midnight Blue	Midnight Blue	Midnight Blue	Midnight Blue	WAP
NEptune	KIT M5 NE MB MB PAB PAB	Midnight Blue	Midnight Blue	Parisian Blue	PARisian Blue	WAP
NEptune	KIT M5 NE GPRS GENERIC					GPRS

3 Exploded Diagram and Spare parts list

3.a MARS

3.a.1 Exploded Diagram of MARS

Note: Frame LCD has been used only for early products.

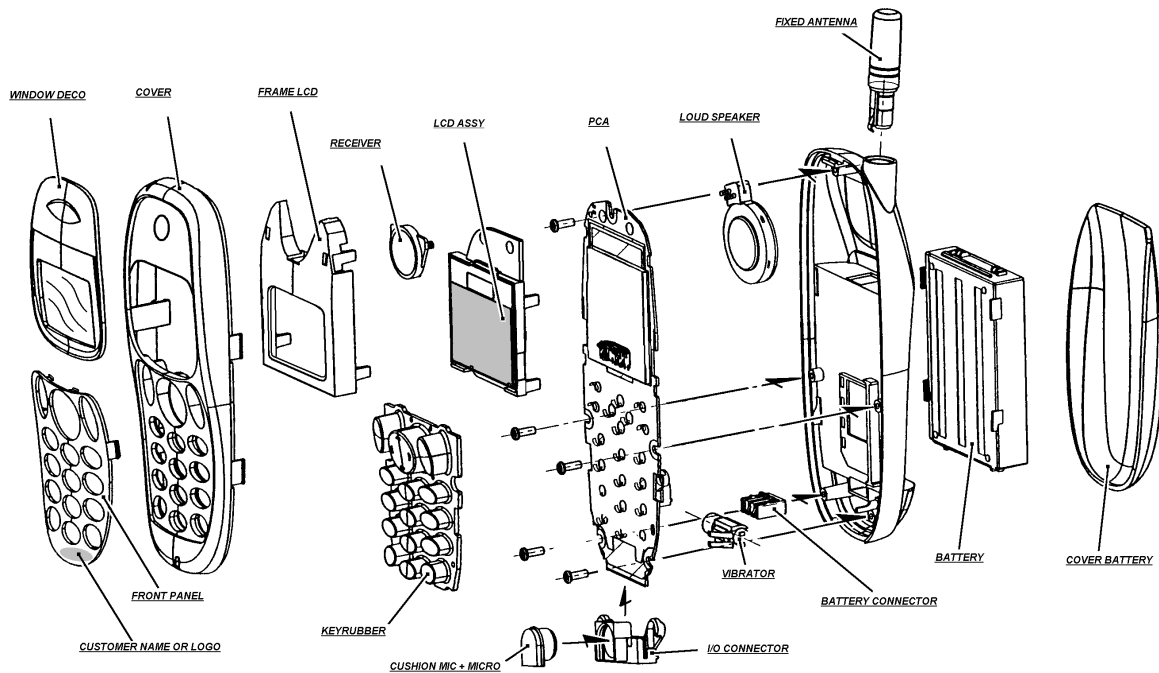

3.a.2 Spare Parts list of MARS

The spare parts list of the Mars is:

Reference	Description	Reference	Description
FK1N005710	Cover Assy M5 MA Ivy Green C25547	FK1W001810	FP M5 MA Silver Cloud C25508 Logo Vodafone
FK1N005910	Cover Assy M5 MA Midnight Blue C95511	FK1W002710	FP M5 MA Midnight Blue Logo D2 C95511
FK1N005810	Cover Assy M5 MA Black Iron C25548	FK1W002810	FP M5 MA Midnight Blue C95511 Logo MOBISTAR
FK1N005610	Case Assy M5 MA Midnight Blue C95511	FK1W002510	FP M5 MA Midnight Blue C95511 Logo OMNITEL
FK1N005510	Case Assy M5 MA Black Iron C25548	FK1W000910	FP M5 MA Silver Cloud C25508
FK1N005110	Battery cover M5 MA Black Iron C25548	FK1W003410	FP M5 MA Silver Cloud C25508 Logo MOBISTAR
FK1N005410	Battery cover M5 MA Midnight Blue C95511	FS2E001910	Antenna M5 MA/NE (already assembled to cover)
FK1N005310	Battery cover M5 MA Silver Cloud C25508	FS2E001310	I/O connector M5 MA/NE
FS2E001410	Micro Assy M5 MA/NE	FS2E001510	Receiver Assy M5 MA/NE
FS2E001610	Speaker M5 MA/NE	FS2E001710	Motor Vibrator M5 MA/NE
FK7P000510	LCD Module Assy M5 MA	FK1B001510	Screw PI TITE Bentz Head TPR N°0 2x6
FS2E000910	Battery connector M5 MA/NE	FS2E00361B	Cap RF MA/NE Dark Grey 532C

Notes:

- Case Assy is made of the case and the antenna
- MA stands for MArS
- NE stands for NEptune

3.a.3 Assembly

Follow the process:

1. Clip the Antenna into the case
2. Stick the Loud speaker onto the case
3. Insert the vibrator onto the case
4. Clip the Battery connector onto the case
5. Clip the micro assy onto the I/O connector
6. Clip the I/O connector into the PCA
7. Place the PCA on the case
8. Screw the 5 screws, beginning with the one 1 then 2 and 3 (1.7 Nm for each screw)
9. Clip the LCD assy on the PCA
10. Stick the receiver on the holder LCD
11. Place the key rubber on the PCA
12. Clip the cover onto the case
13. Stick the window on the cover
14. Clip the flip (Front panel) of Neptune (Mars)

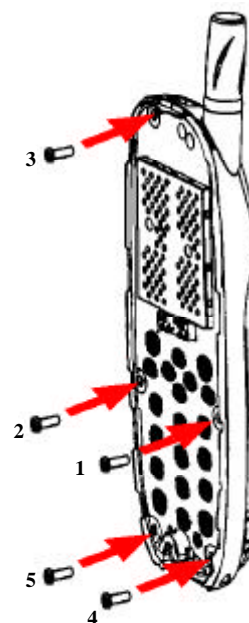

3.b NEPTUNE

3.b.1 Exploded Diagram of NEPTUNE

Note: Frame LCD has been used only for early products.

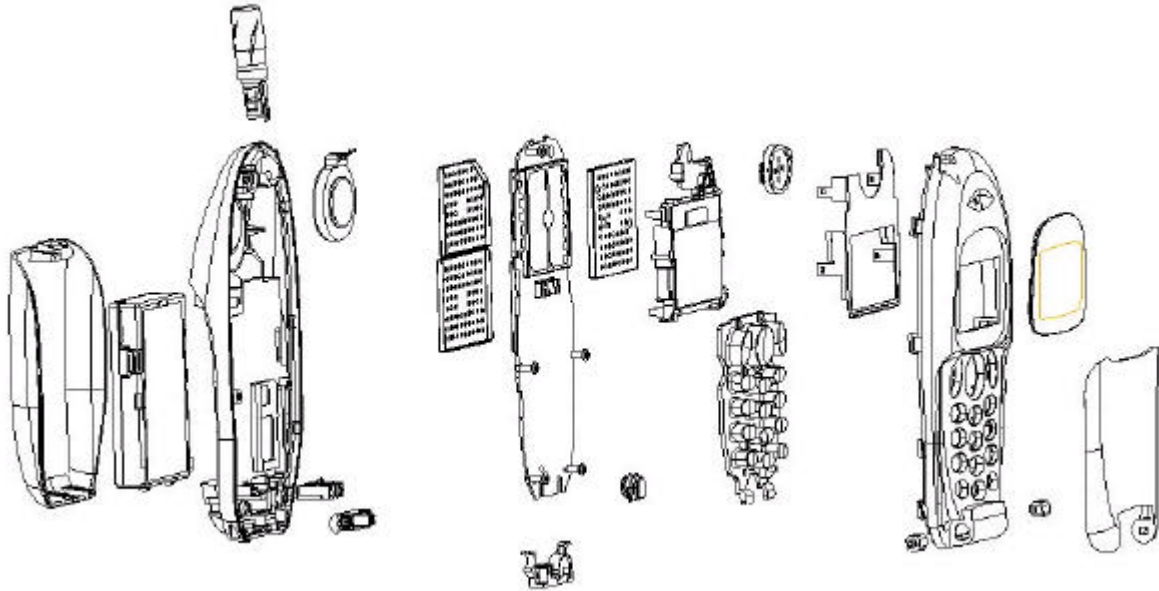

3.b.2 Spare Parts list of NEPTUNE

To be defined.

3.b.3 Assembly

To be defined.

4 Test and Measurement

4.a Charging measurements

To check the charging, we use a modified AC/DC and an ampermeter connected as follow:

When you plug the charger into the wall socket, the charging current is displayed by ampermeter. The charging indicator scrolls on the LCD and the top LED lights up red.

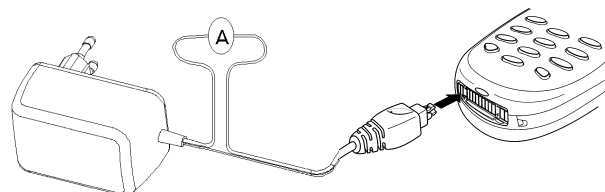

Switch off the mobile with battery, but without SIM card.
After plugging the AC/DC, "charging" message is displayed on the LCD.
When backlight is active, the precharge current is about 150 mA, and then 530 mA. When the backlight switches off, the current decreases to about 450 mA.

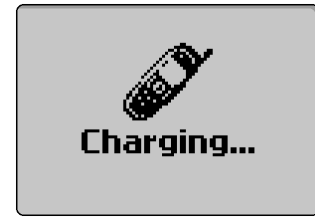

For more details about charging, see the LEVEL 3 SERVICE MANUAL FA9M0605.

4.b E-GSM / DCS measurements

4.b.1 Transmitter Power and Ramp profile

These two are interrelated, since the power ramp shape and its final peak value are stored in EEPROM as adjustment values.

The peak power output must lie within 3 dB of specification and be flat to within 0.5dB over the active period. The ramp profile is designed to give minimum harmonics, and hence it is important to ensure it is adhered to.

Power ramp profile are checked on the channels:

- 975, 37 and 124 for the 900 MHz band
- 512, 698 and 885 for the 1800 MHz band

In conclusion, the ramp must fit the mask at all frequencies and all power levels. The mask is usually stored in the radiocommunication tester. The test will also be available to cover the frequency and power range automatically.

4.b.2 Phase/ Frequency/ Time relationship

This is a test of the quality of the modulation including the IQ balance and the Gaussian filters. The phase of the carrier changes according to the arrival of 1s and 0s. Phase error must not be more than 20° peak or 5° RMS.

4.b.3 Receiver Bit Error Rate (RX sensitivity)

The specification is a Bit Error Rate (BER) of better than 2.44% for an input signal : -102 dBm for the E-GSM 900 band, and -100 dBm for the DCS 1800 band. There should be no error for -90 dBm to -20 dBm input signal. The maximum workable error rate is 13%.

It is important that BER and RX sensitivity are good since measures of RXLEV (from -103 to -41 dBm) and RXQUAL (from 0 to 10%) are reported back to the base station on the SACCH to assist in handovers and power level control. Errors in reporting will lead to sub optimum use of channel space, or interference to others.

4.b.4 Handover between E-GSM 900 and DCS 1800 standards

The M5 dual band may handover from the E-GSM 900 band to the DCS 1800 band automatically. If the subscribed network has frequencies in both bands, the M5 dual band will work either in 900 MHz or 1800 MHz band depending on the availability of frequencies.

4.c Operating instructions

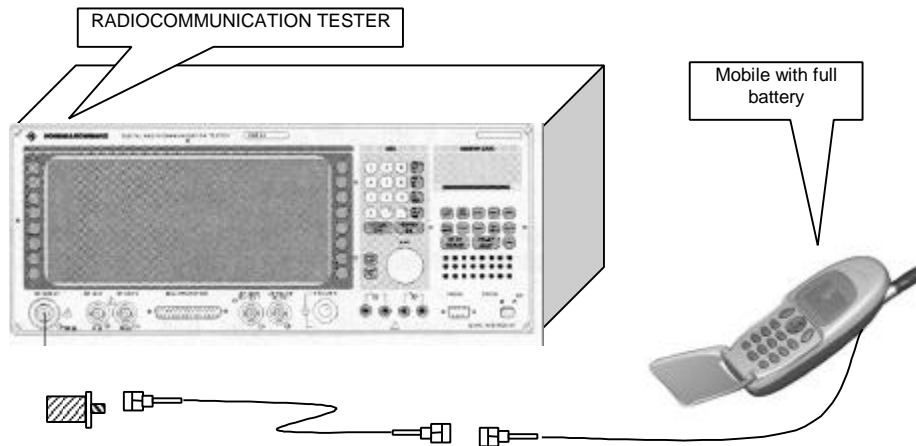

1. Insert Test SIM card in mobile
2. Connect a charged battery
3. Make a call with RADIOCOMMUNICATION TESTER and check following parameters or use the autotest (CMD55 or CMD55 under MTS or Wavetek 4107)

E-GSM 900 PCL	Power Level (dBm)	tolerance
5	33	+/-2dB
6	31	+/-3dB
7	29	+/-3dB
8	27	+/-3dB
9	25	+/-3dB
10	23	+/-3dB
11	21	+/-3dB
12	19	+/-3dB
13	17	+/-3dB
14	15	+/-3dB
15	13	+/-3dB
16	11	+/-5dB
17	9	+/-5dB
18	7	+/-5dB
19	5	+/-5dB

DCS 1800 PCL	Power level (dBm)	tolerance
0	30	+/-2dB
1	28	+/-3dB
2	26	+/-3dB
3	24	+/-3dB
4	22	+/-3dB
5	20	+/-3dB
6	18	+/-3dB
7	16	+/-3dB
8	14	+/-3dB
9	12	+/-4dB
10	10	+/-4dB
11	8	+/-4dB
12	6	+/-4dB
13	4	+/-4dB
14	2	+/-5dB
15	0	+/-5dB

Power ramping: Check that the burst fits the mask below

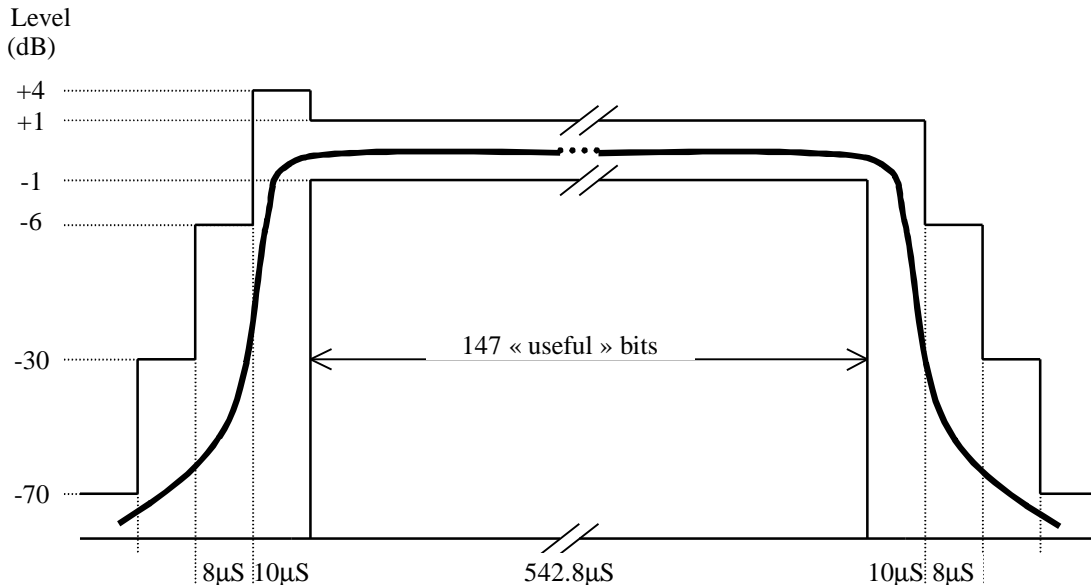

RX levels: Check the values for different signal strengths

RX LEVEL	RSSI (dBm)
0	Less than -110 dBm
1	-110 to -109
2	-109 to -108
27	-84 to -83
50	-61 to -60
62	-49 to -48
63	Better than -48

Bit error: Check the value for different types

Check the Reception Bit Error Rates (RBER) and Frame Error Rates on channels 1, 62 and 124 at -102 dBm for GSM band and on channels 512, 698 and 885 for the DCS band according to the following specifications:

Bit error type	Value
RBER Class Ib	< 0.41 %
RBER Class II	< 2.44 %
FER	< 0.12 %

4.d Buzzer, Receiver and Speaker tests

Insert a test SIM in a mobile with a battery.

Go to **Volume** across the path: Home menu>**Settings**>**Phone settings**>**Tones**>**Volume** and scroll to the item to be adjusted.

- Test Buzzer/loud Speaker: **Ring, Ramping, Alarm** volume. Select the item and use ▲ and ▼ keys to decrease or increase the volume of **buzzer**. Make a real communication and test the loud speaker.

- Test Receiver: Select **Conversation** or **Keys** and use ▲ and ▼ keys to decrease or increase the volume of **speaker**.

5 Download of software and Setting (Perso)

The software in the mobile consists of two files downloaded independently:

- The first file (.bin) is the core of the software managing the mobile functions themselves. This is downloaded using IPLTrium
- The second file (.pso) is the setting file managing the default settings (ringing, customization...). This is downloaded using MS Tools.

MS Tools also allows to enter test mode in order to reset user data (security code), to print labels (IMEI & factory name plate).

From now, we use soft as software file (.bin) and setting as perso file (.pso)

5.a IPLTrium2000

This part describes how to use the IPLTrium2000 software.

To download a software file (.bin), you need IPLTRIUM software, and the mobile must be with battery.

To download the soft, your phone is connected to your computer:







- Using the interface box "Interface Simplifiée Mitsubishi", usually used for Level 3 repair. Therefore, see the Service Manual Level 3 ref. FA9M0605
- Using PC cable, that is described as below

5.a.1 Difference between IPLTrium and IPLTrium2000

Before downloading software in a mobile, the type of the flash needs to be identified. As the flash are different, the ways to download mobiles are different.

For M4 family, there were 4 different "loaders".

By using the new IPLTrium, you can choose the phone you want to soft, and the loader is automatically set. Moreover, there are only two different loaders for the M4 & M5 family.

IPLTrium				IPLTrium2000	
 Iplm4mo.bin	 Iplm4so.bin	 Iplm4gp.bin	 Iplm4gpp.bin	 Iarm.bin	 Ithumb.bin
Astral, Galaxy, Geo	Aria, Aria Wap	Geo Wap	Geo GPRS	Cosmo, Cosmo Wap, Geo GPRS	Astral, Galaxy, Geo Wap, Aria, Aria Wap, Mars, Neptune, MCT, Laser

Some information is displayed on the screen of the phone (old IPLTrium), and by checking the indicator, one is able to know the status of the progress.

Note: From now, we use IPL or ILP2000 or IPLTrium for IPLTrium 2000

5.a.2 Equipment and installation of IPL Trium

5.a.2.1 Equipment description

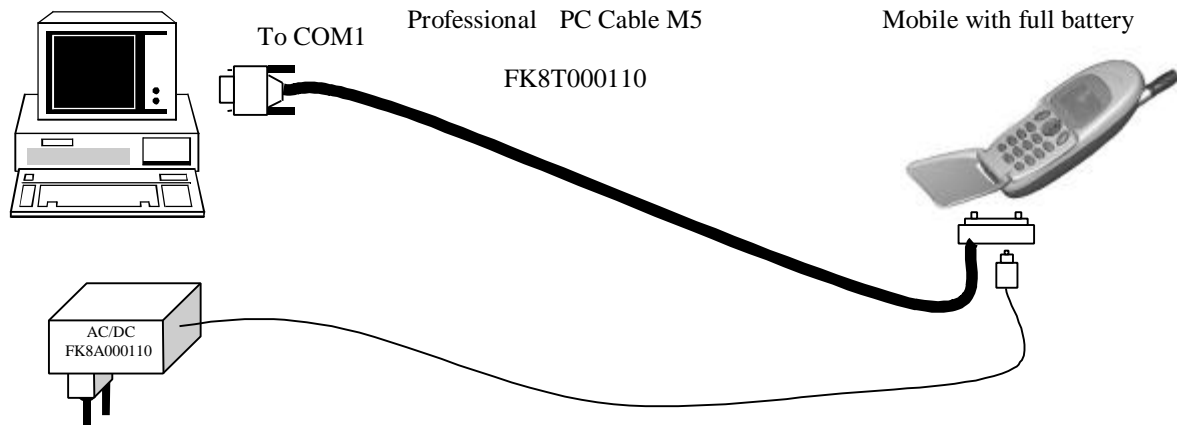

Notes:

- A battery fully charged is fitted on the phone
- Switch off the mobile before plugging the PC cable
- The AC/DC can be used
- Nothing appears on the LCD of the phone
- You do not need to switch off the PC before plugging PC cable

5.a.2.2 Installation

IPL Trium is available on Windows 95, 98, NT4 OS and is made of 15 different files:

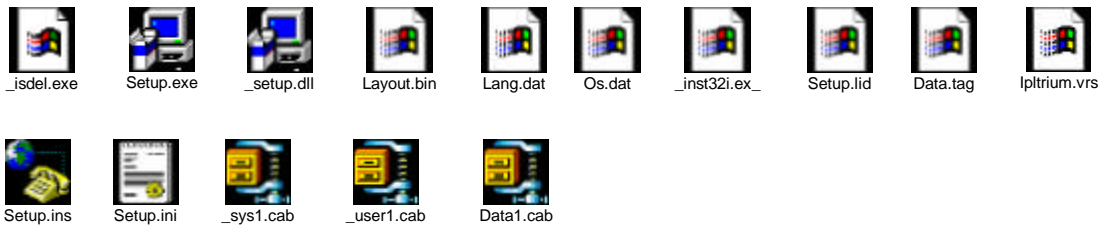

(These files can be provided under one ZIP file)

To install IPLTRIUM software, launch the programme **Setup.exe**, and follow the instructions.

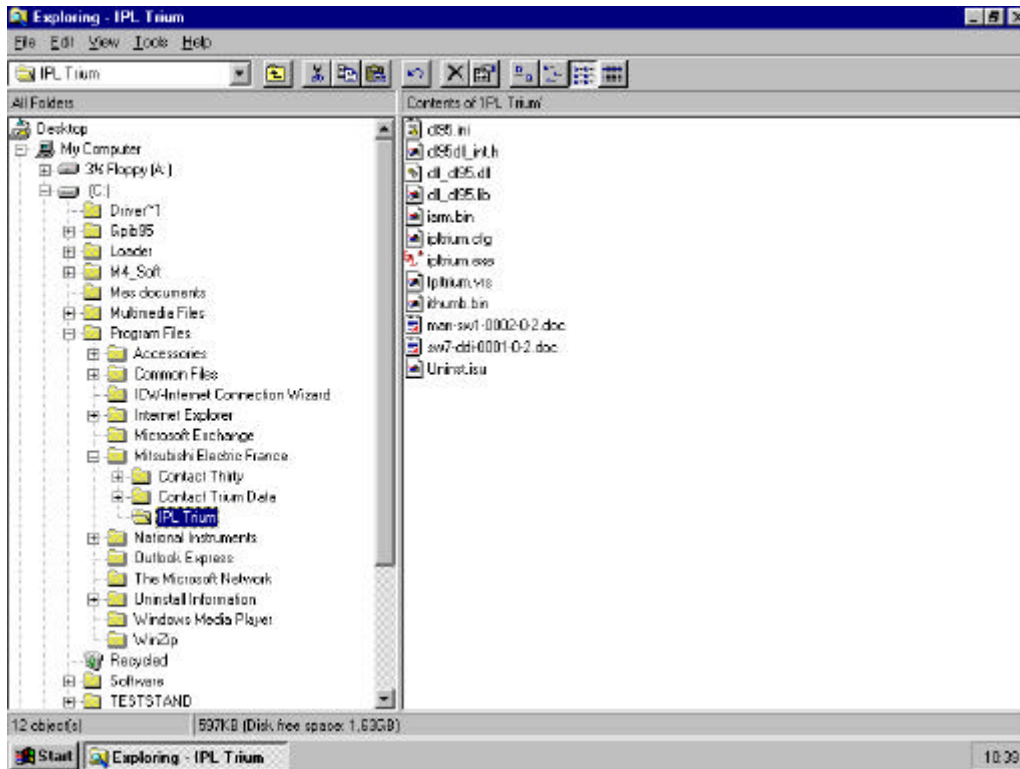

Note: The folder **IPLTrium** is created, and 12 documents under it.

5.a.2.3 To launch IPL

Click or double click on **ipatrium.exe** in Windows Explorer (same path that above).

Or choose **IPLTrium** in menu.

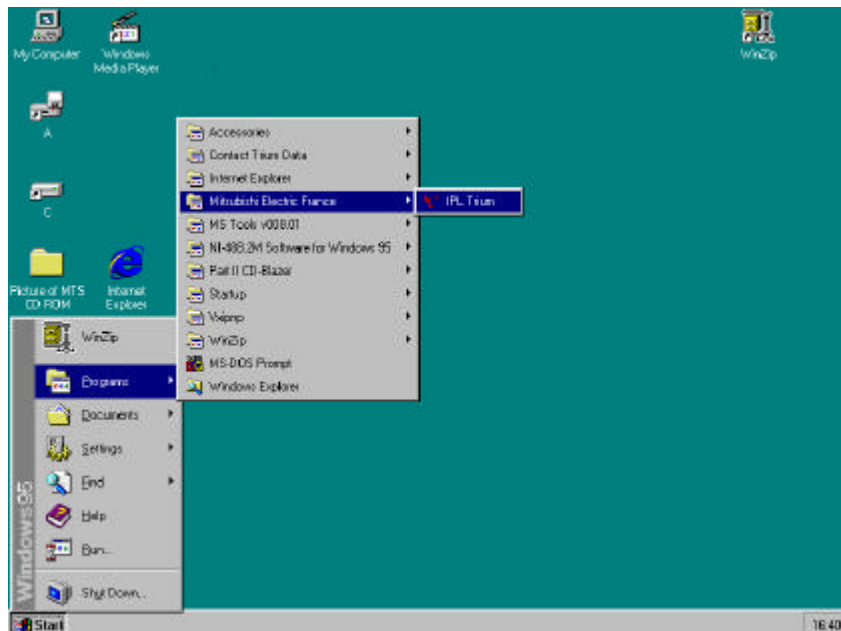

5.a.3 Description of IPLTRIUM

The "IPL" software runs under WINDOWS 32 Bits.

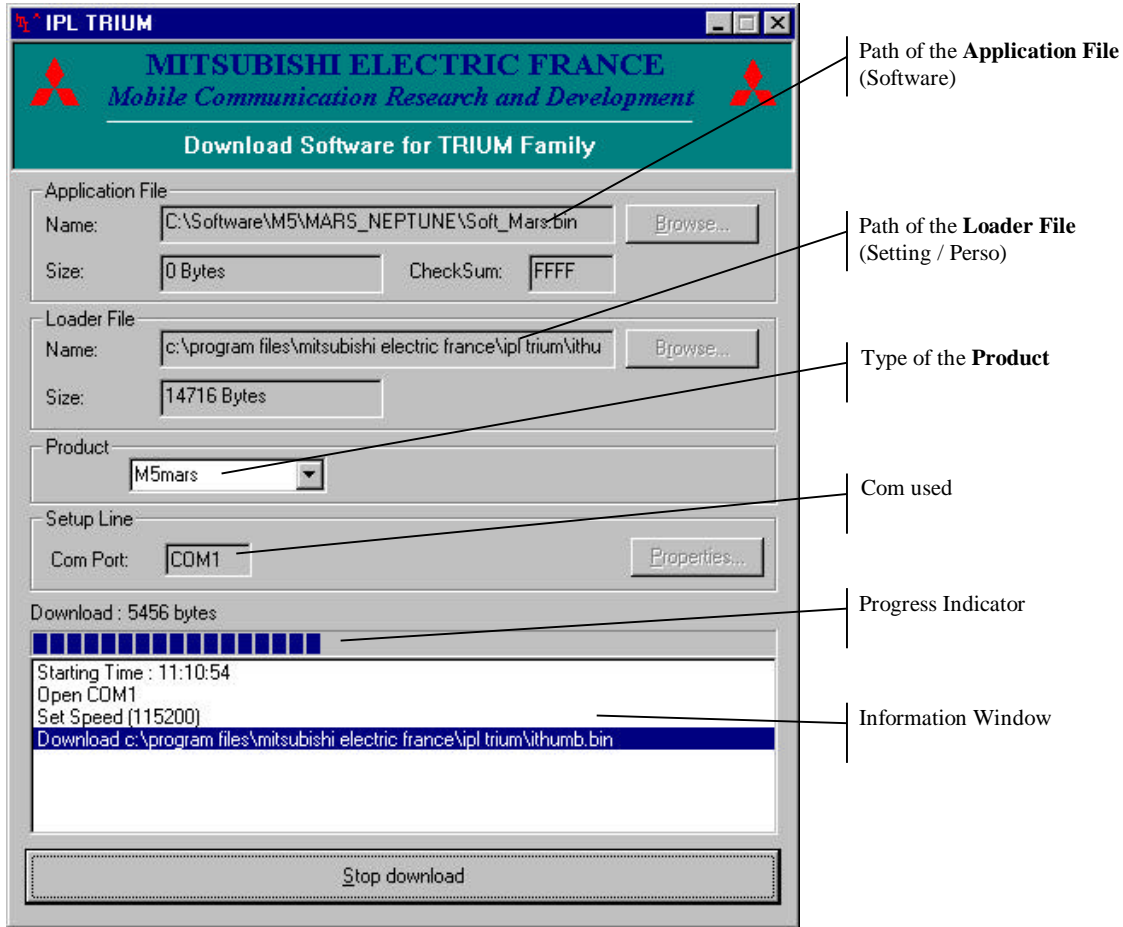

5.a.3.1 Application File

We advise you to create special folders with all the softs for each phone. For instance, we have created these ones under (C:) (C:\Software\M5\MARS_NEPTUNE), and we have recorded the software file (Soft_Mars.bin) under the last folder.

The field **Application File** indicates the path of the software. It depends on where the user had recorded it. This path can be changed by clicking on the key **Browse....**

One obtains the window below.

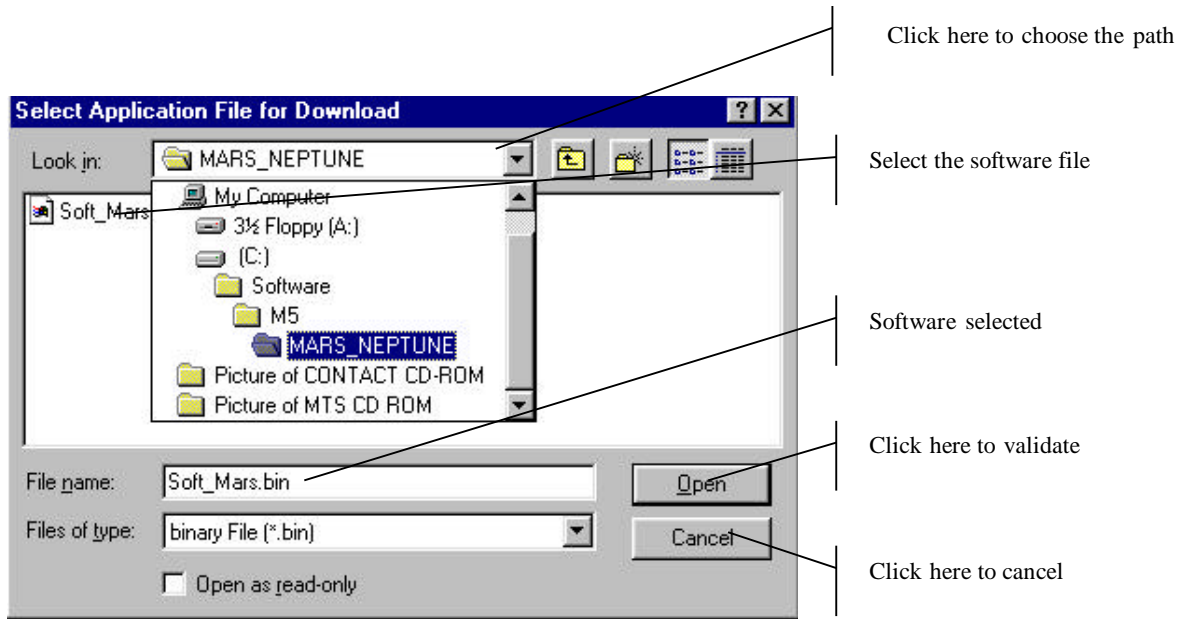

5.a.3.2 Loader File / Product

It indicates the path of the software. It depends on where the folder IPLTrium is recorded. This loader is fixed by choosing the type of phone in the field **Product**. Anyway, the loader file can be changed by clicking on the key **Browse...None** is displayed on the product field.

If ever you have to recorded new loader, we advise to create special folders as above.

- The product is recorded:

Click on the arrow to see the list of the phones.

Note that:

- **Eclipse** stands for Cosmo and Cosmo WAP
- **Geo++** stands for Geo GPRS
- **Geo+** stands Geo Wap
- **Aria** stands for Aria and Aria WAP
- **Galaxy** stands for Astral, Galaxy and Geo
- **M5Mars** stands for Mars and Neptune

None stands for no telephone recorded and one can change the loader by clicking on **Browse...**

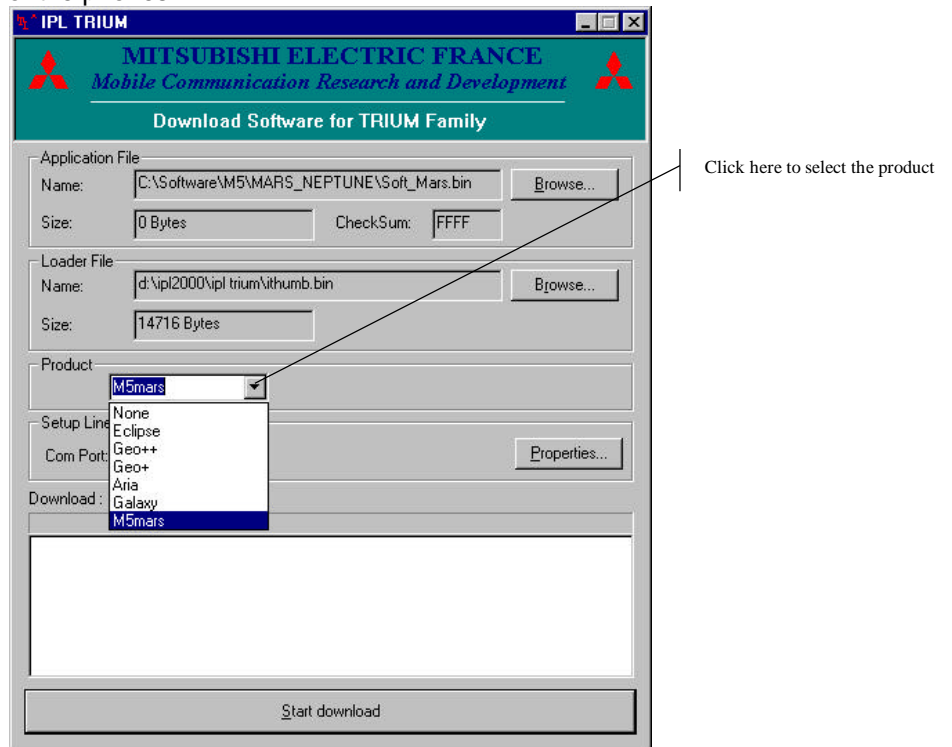

(See 5.a.1 Difference between IPLTrium and IPLTrium2000 to get more information about the loader)

- The product is not recorded

Click on **Browse...** in the **Loader File** field to get the window below. (For instance, we have recorded the loader loader_Mars.bin under the path C:\Loader\M5\MARS_NEPTUNE)

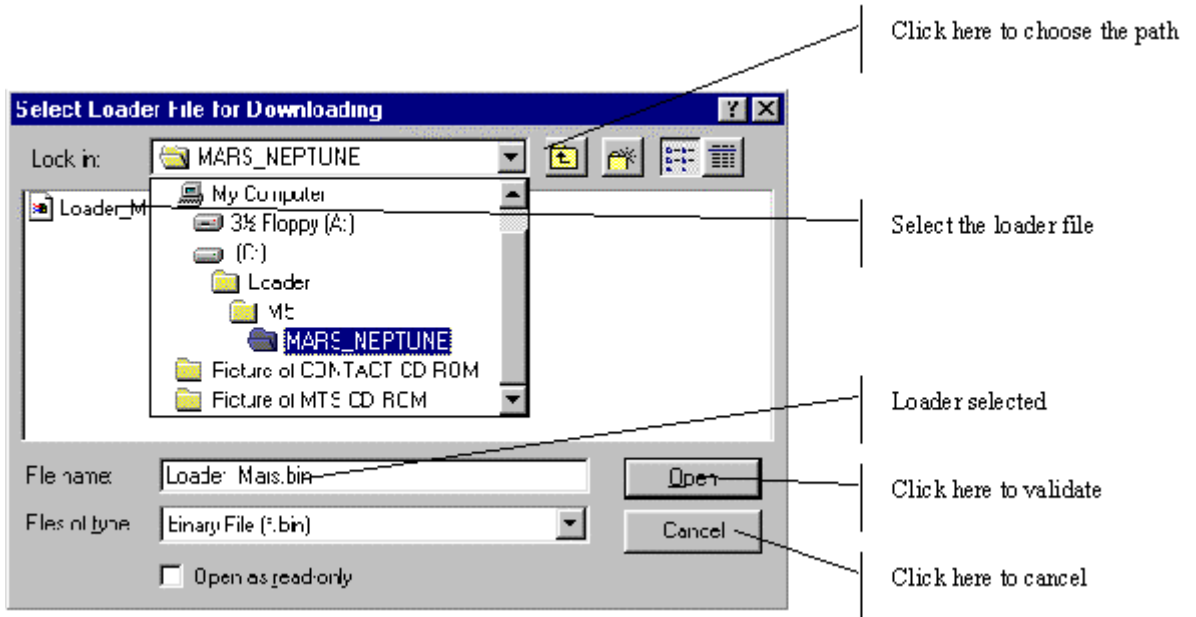

5.a.3.3 Setup Line

It indicates the com used. One can change the configuration of the port by clicking on the key **Properties....** One obtains the window below.

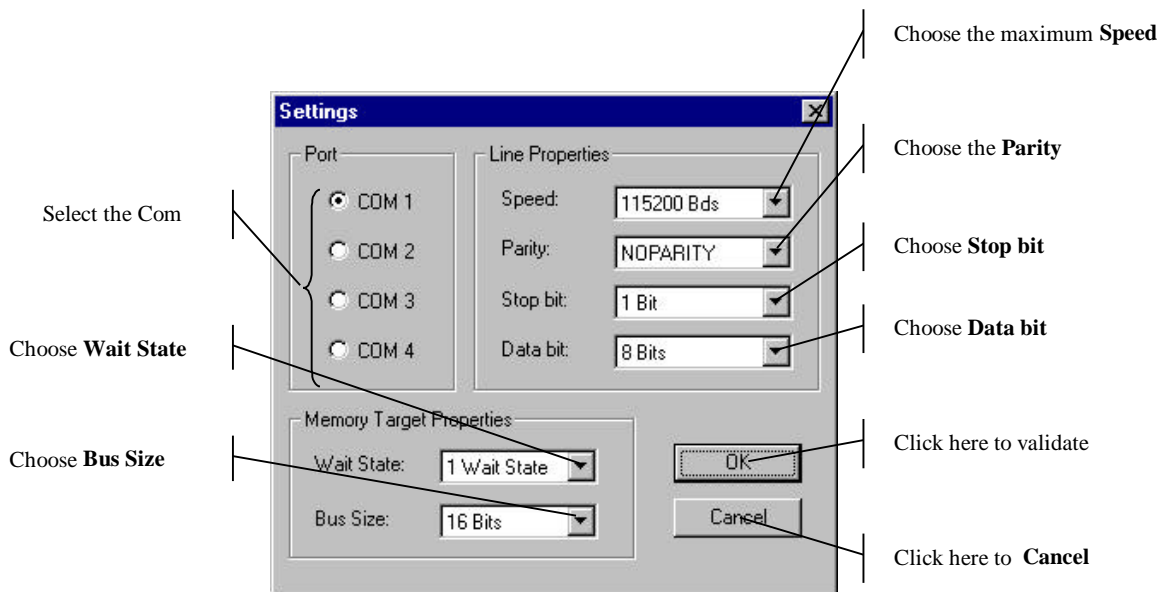

Note: these parameters depend on the phone you want to soft. The data above are linked with the Mars and Neptune.

5.a.4 To use ILPTRIUM

5.a.4.1 Start download.

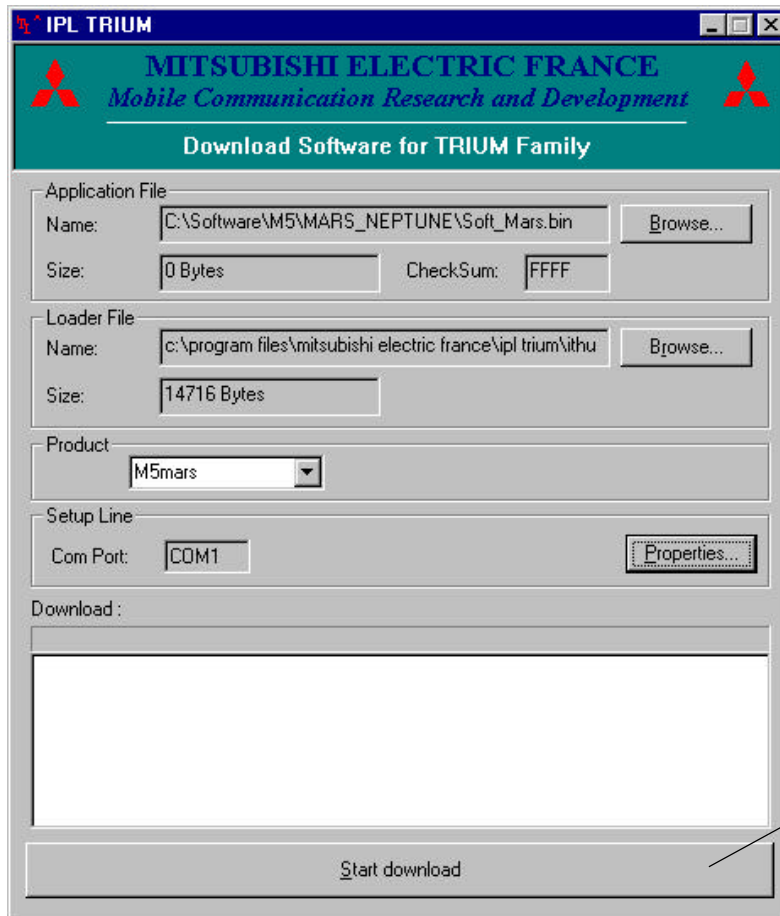

Click here to **Start download**

There are two ways to connect the mobile

- With the AC/DC: take a mobile with full battery, switch it off. Plug the PC cable and the AC/DC. The LED indicator is red. Click on **Start download**. The LED becomes green, and starts flashing during the process.
- Without AC/DC charger: hold the on/off key of the phone (it does not switch on) and click on **Start download**. Keep holding the on/off key until the LED is flashing green.

Information about processing is shown along download line (bytes transferred, and steps of downloading) in the information window.

You can stop the downloading at any time by clicking on **Stop download**. By removing the mobile from the PC cable before the end of the download, the mobile may be damaged. If some one cannot download soft anymore, leave the phone without battery for one hour and try again to download soft.

Note: Nothing is displayed on the LCD of the phone. Check the indicator. The LED should be flashing green during the download.

5.a.4.2 End of download

Wait for the message "---- DOWNLOAD COMPLETED -----" on the information windows of IPL.

At the end of the download (the progress indicator is full), the LED indicator is to be green and not flashing. When an error occurs (except for unknown flash) the LED flashes red. Count the number of blinks to determine the error, i.e. 6 blinks = Flash programming error.

Note: there will be a pause between the error blinks i.e. 6 links, pause, 6 blinks, pause...

Blink number	Description	Blink number	Description
1	Checksum error on received frame	10	Unexpected interrupt
2	Unexpected frame size	11	Receiving Buffer full
3	Uart receiving Error	12	Flash too small to contain application
6	Flash programming error	14	Flash access error
7	Flash erasing error		

Remove the PC cable (with or without the AC/DC charger) and the battery. To check the soft downloaded see 6.6.b Software version

IPL is to be compatible with the flash:

- | | |
|---|--------------------------------|
| FUJITSU MBM29LV800TA (1Mbytes) | AMD AM29LV800BT (1Mbytes) |
| FUJITSU MBM29LV160T (2Mbytes) | SGS THOMSON M29W800T (1Mbytes) |
| INTEL 28F800B3T (1Mbytes) | INTEL 28F160B3T (2Mbytes) |
| INTEL 28F160C3B (2Mbytes) | INTEL 28F160C3T (2Mbytes) |
| MITSU M5M29GT160B/M5M29GT161B (2Mbytes) | |
| AMD AM29DL163CT (2Mbytes) | AMD AM29DL162CT (2Mbytes) |
| AMD AM29LV160T (2Mbytes) | FUJITSU MBM29LV160B (2Mbytes) |

This application saves the last setting in the configuration **file.ini**. When the software restarts, these settings are loaded automatically.

5.b MStools

This part describes how to use the MStools software.

To download a setting file, or to print IMEI label or Label Art, you need MStools (version 10 or higher) software.

To download the setting, your phone is to be into "Mitsubishi Testmode" state.

- Using the interface box "Interface Simplifiée Mitsubishi", usually used for Level 3 repair. Therefore see the Service Manual Level 3 ref. FA9M0605
- Using PC cable, that is described below

5.b.1 Equipment and installation of MStools

5.b.1.1 Equipment description

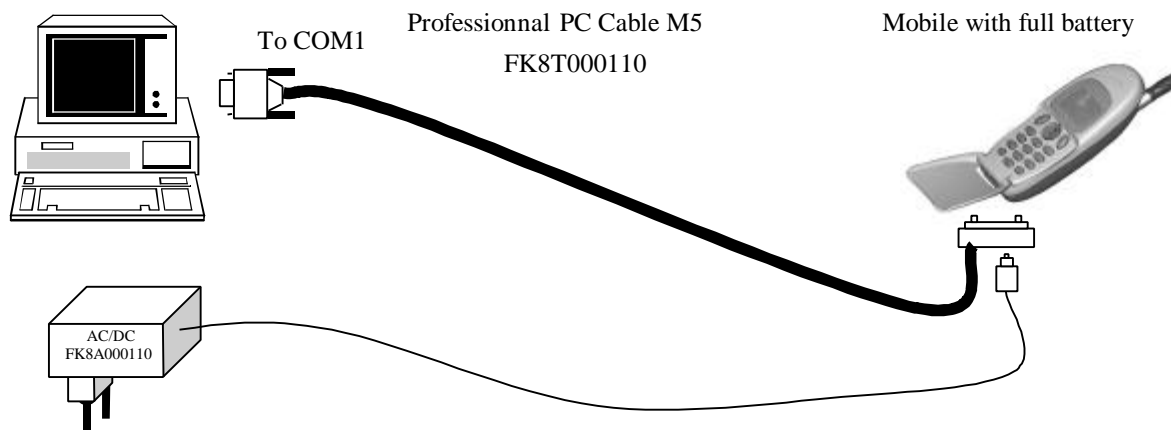

Notes:

- Same equipments that is used for IPL
- The mobile is with full battery
- You do not need to switch off the PC before plugging PC cable

5.b.1.2 Installation

MStools is available on Windows 95, 98, NT4 OS and is made of 3 different files:



(These files can be provided under 2 floppy disks)

Before installing a new version of MStools, be sure to uninstall the old one.

To install MStools software, we suggest you should record the file in a temporary folder, and then launch the programme **Setup.exe**, and follow the instructions.

At the end of the installation, you have to delete the temporary folder.

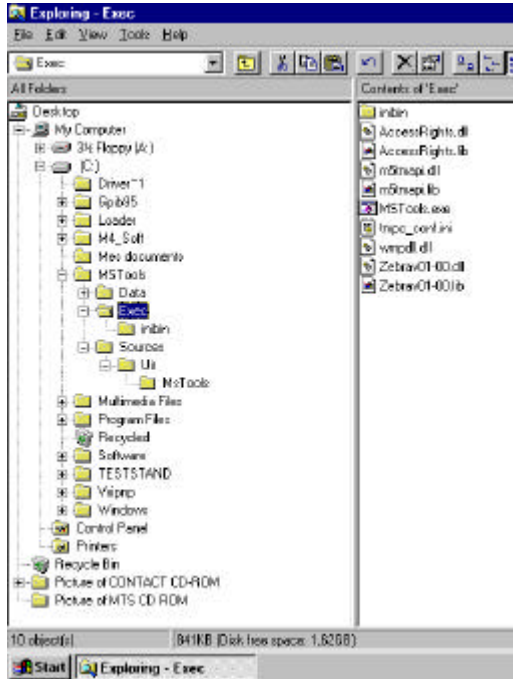

Notes:

- The folder **MStools** is created, and 3 sub-folders under it.
- **MSTools.exe** is at the end of the path C:\MSTools\Exec.
- Some problem may occur if the file MFC42.DLL onto your computer is too old. Contact your computer administrator.

5.b.1.3 To launch MStools

Click or double click on **MSTools.exe** in Windows Explorer (same path as above)

Or choose **MSTools** in menu

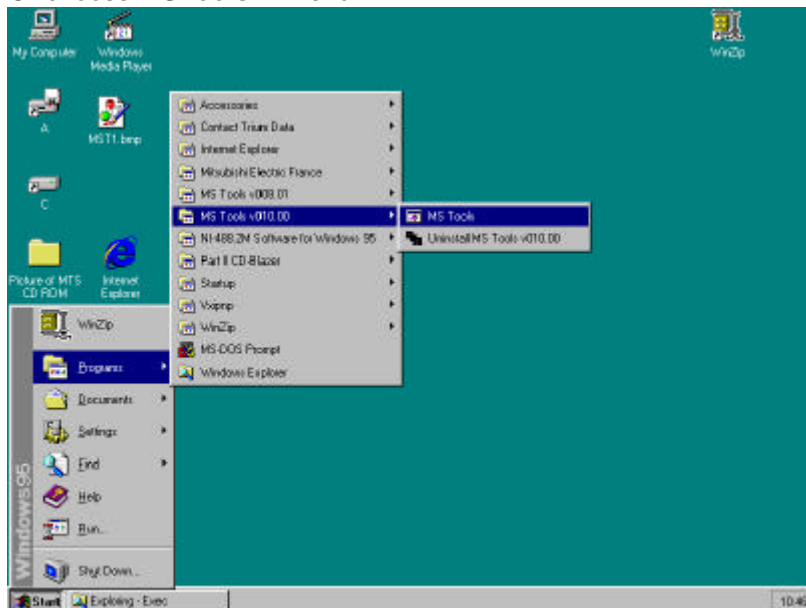

This picture was made with MSTools version 10.

5.b.2 Description of MStools

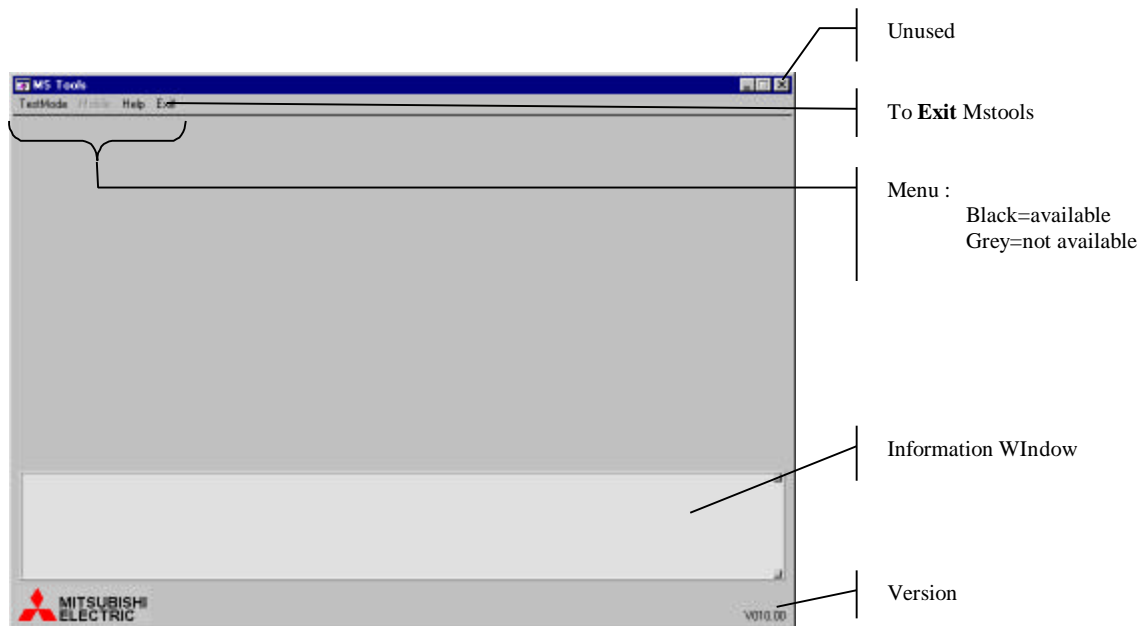

To get all the menu available, you have to link the mobile and MStools (see below).

5.b.2.1 TestMode menu

5.b.2.1.1 Start from ...

Your phone is to be linked with MStools. There are two ways to have this connection (they are both good):

- Your phone is into TestMode state

If you are using the interface box or you have kept on pressing * during the dial 5 4 7 2 (before plugging PC cable)

One can connect the phone by choosing **Start from TestMode**. The message "Start TestMode... Operation completed." is displayed in the information window.

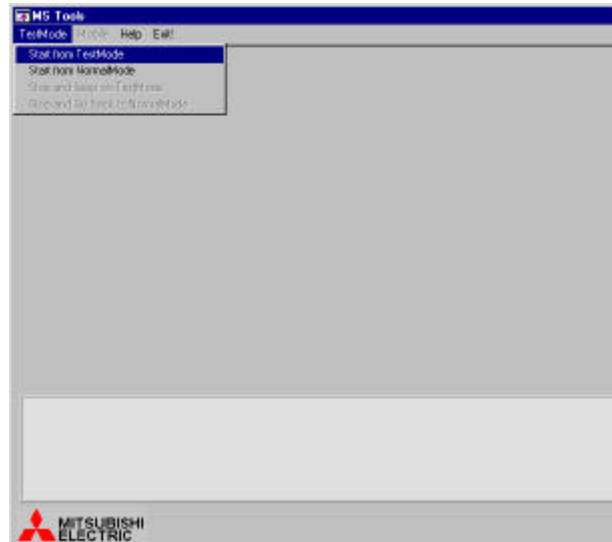

- Your phone is not into TestMode state
Plug the PC cable into a switched-on mobile.
One can connect the phone by choosing **Start from NormalMode**, then the message “Mitsubishi testMode” is displayed on the phone. The message “Start TestMode... Operation completed.” is displayed in the information window.

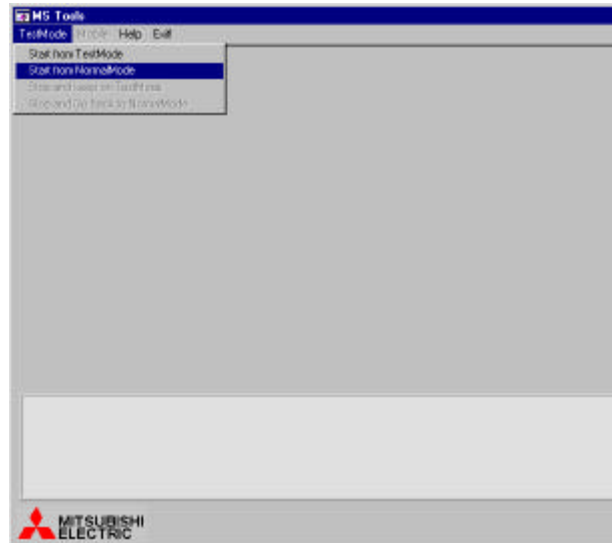

Now you can use MSTools functions.

5.b.2.1.2 Stop and ...

When you have finished with a phone, you have to disconnect the link before linking with another phone.

- Stop and keep on TestMode**

Your phone is no longer linked with MSTools, but it is still in TestMode state

- Stop and Go back to NormalMode**

Your phone is no longer linked with MSTools, and you have left the TestMode state

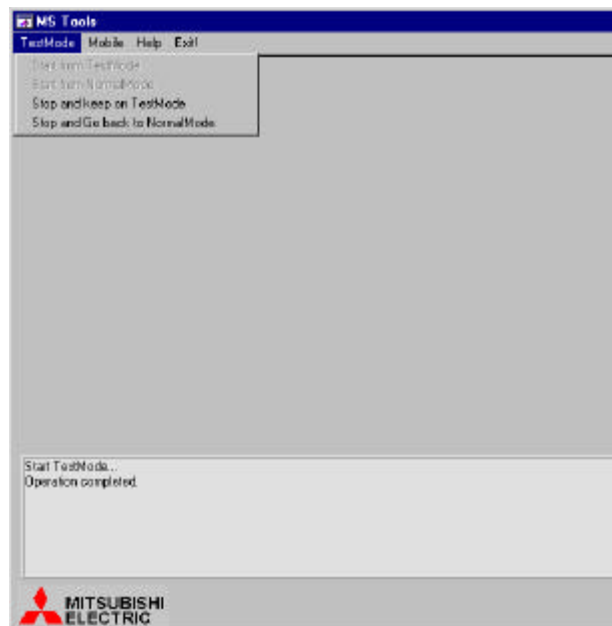

5.b.2.2 Mobile menu

After having linked the mobile with MSTools, the menu **Mobile** is available.

Three sub-menu are provided:

- Download personification
- Initialization data users
- Mobile identification

Mobile is available

The phone is correctly linked

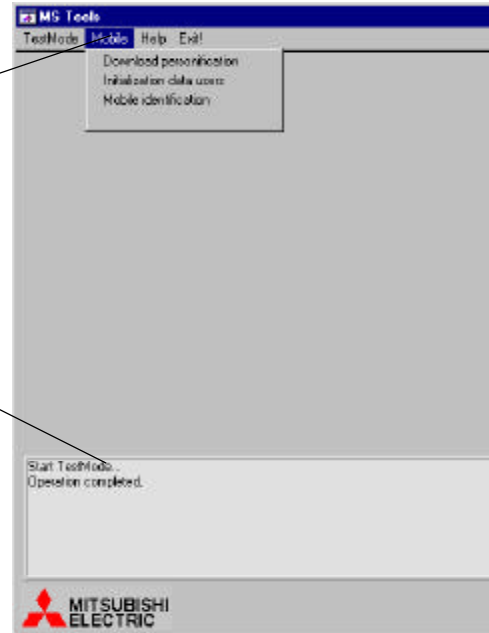

5.b.2.2.1 Download personification

This function allows you to download the setting.

We advise to create special folders with all the settings for each phone.

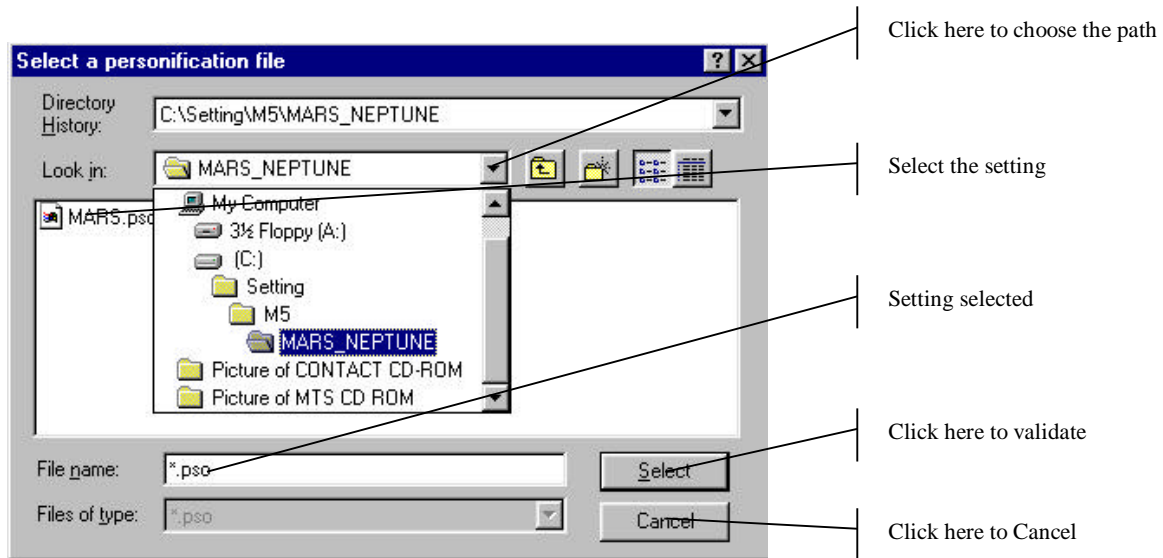

The message "Personification data downloading...Operation completed." is displayed in the information window to confirm that the setting has been successfully downloaded.



5.b.2.2.2 Initialization data users

Some parameters can be changed by the user: volume, ringing, lock code..., this function allows you to re-initialize the mobile. The message "Initialization data users...Operation complete" means that the operation has been successfully completed.

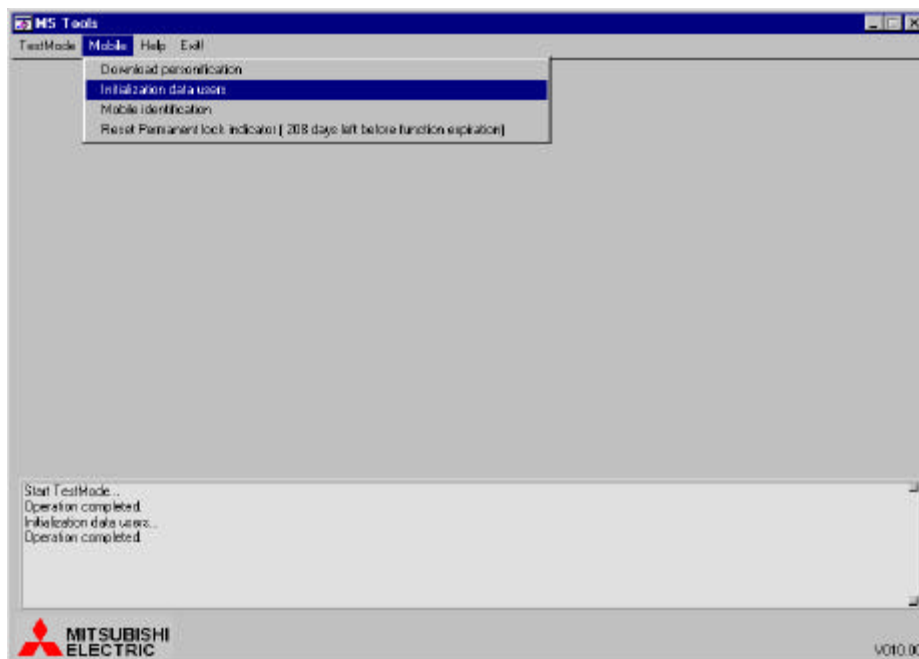

Notes:

- you have to download the setting again to the mobile after the having chosen **Initialization data users**
- "Enter lock code:" can be turned off by this way

5.b.2.2.3 Mobile identification / How to print labels

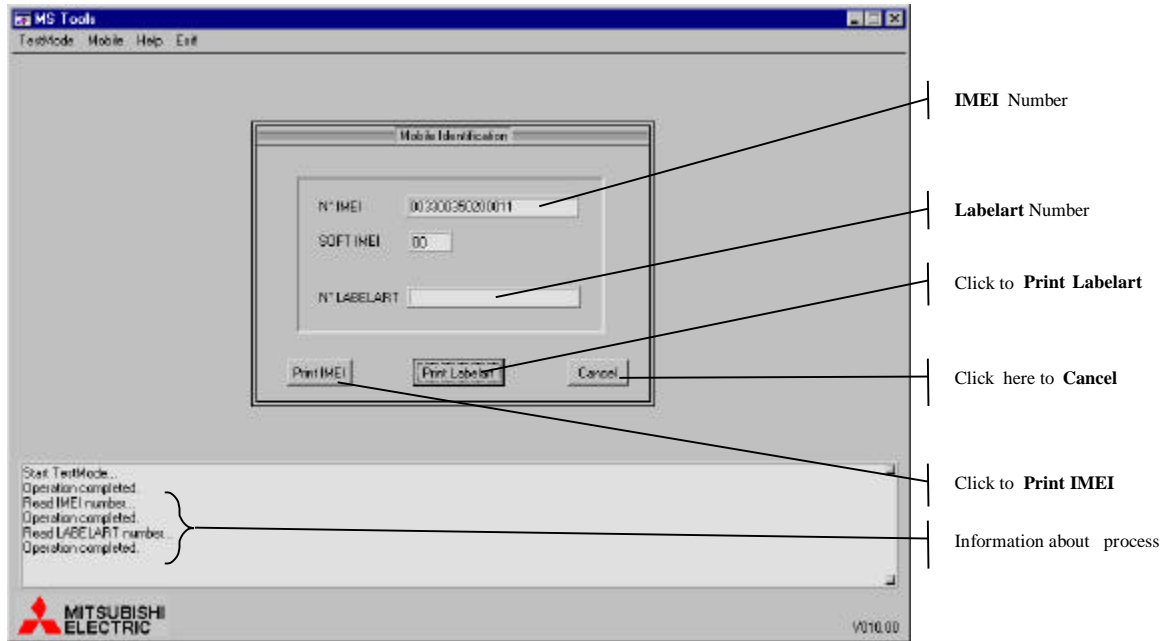

You can print either IMEI number or Labelart number by clicking on the button

- **Equipment description:**

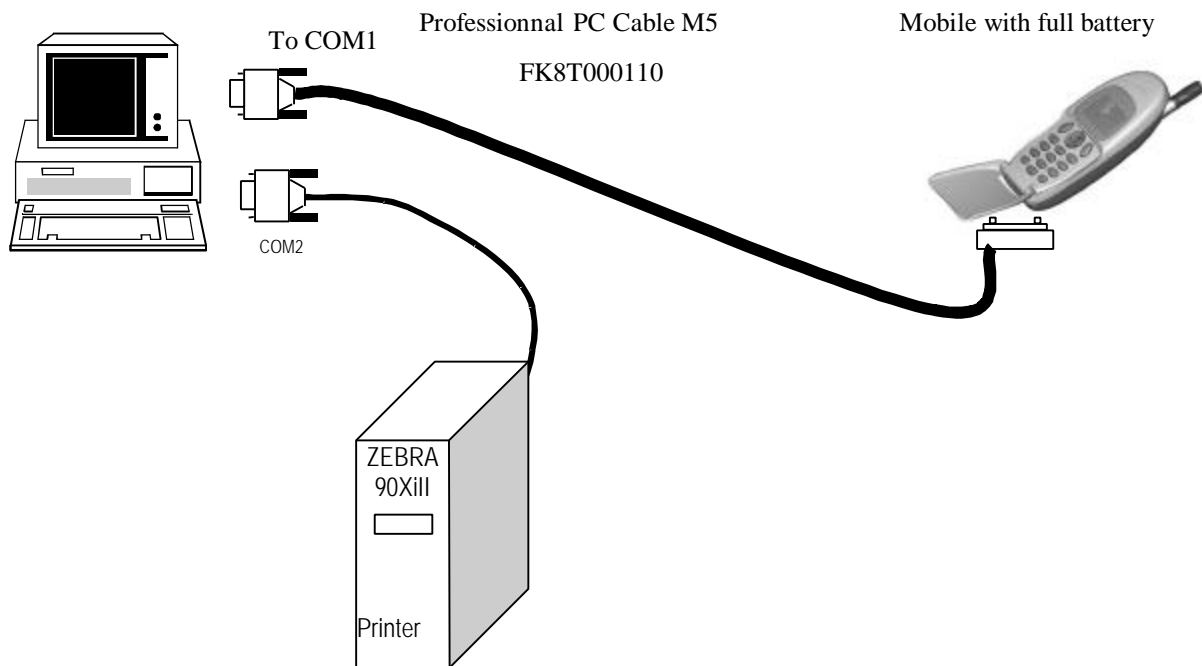

MS Tools software version 10.00 (or higher) is required to print labels.
MS tools program does not send information directly to **ZEBRA 90Xi II printer**, it sends information to NI VISA driver and NI VISA driver sends information to ZEBRA 90Xi II printer.

- **Driver required: NI VISA**

NI VISA driver is required and can be provided by MITSUBISHI ELECTRIC TELECOM EUROPE.

The NI VISA driver is located on **NATIONAL INSTRUMENTS NI 488.2** CD-ROM

To install this driver on your PC, launch the **setup.EXE** which is located in the **NI-VISA** folder on the CD-ROM.

- **Print IMEI**

Click on Print **IMEI**

The window **Mobile Identification** is display, you have to write the code of the phone and of the latch:

- MT-050 MARS 23415-B
- MT-250 NEPTUNE

Then Click on **OK**

The process is (displayed in the information window):

- Loading file...
- Operation completed.
- Open printer handle...
- Operation completed.
- Printing Label...
- Operation completed.
- Close printer handle...
- Operation completed.

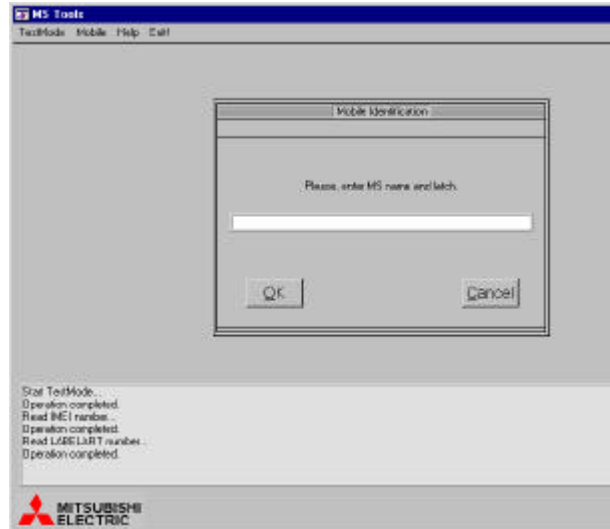

- **Print Labelart**

Click on Print Labelart

The process is (displayed in the information window):

- Loading file...
- Operation completed.
- Open printer handle...
- Operation completed.
- Printing Label...
- Operation completed.
- Close printer handle...
- Operation completed.

5.b.2.3 Other menu

You can get some help by clicking on **Help** menu

To exit MStools you must click on **Exit!**

6 Codes

Before making a code, you need to switch on the mobile

6.a TestMode

Hold * and dial 5 4 7 2

The message "Mitsubishi Testmode" is displayed on the LCD

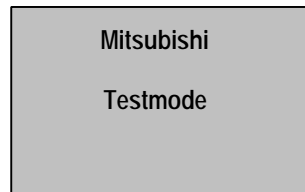

6.b Software version

Hold the * key and dial 5 8 0 6.

Then on the mobile, the following message is displayed ,
for example :

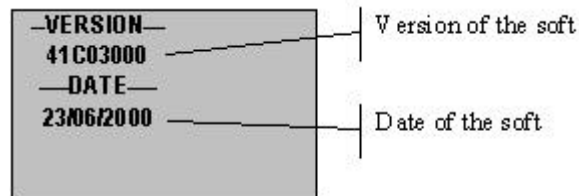

6.c Software and Perso version

Hold the * key and dial 5 8 0 7.

Then on the mobile, the following message is displayed ,
for example :

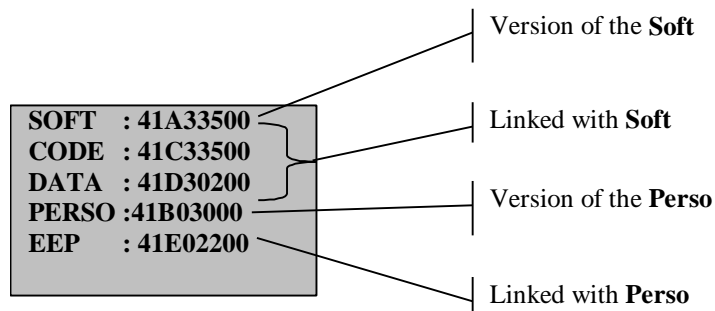

7 Operator Debugging

To display the RX level (in dBm), insert the SIM card (from service provider or test SIM card using CMD in manual test), connect a charged battery and press the power key. When the mobile displays the network (real network or test network 001-01), hold the * key and dial 4 3 2 9.

Then on the mobile, the following message is displayed, for example:

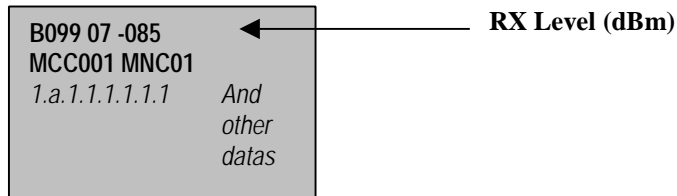

To exit from the Operator debugging mode, use the same command: hold the * key and dial 4 3 2 9.

8 PERSONNAL NOTES

Mitsubishi Electric reserves the right to make changes to its products at any time to improve reliability or manufacturability. Mitsubishi Electric does not assume any liability arising from the use of any device or circuit described here in, nor does it convey any license under its patent rights or the rights of others.