

RF & BB

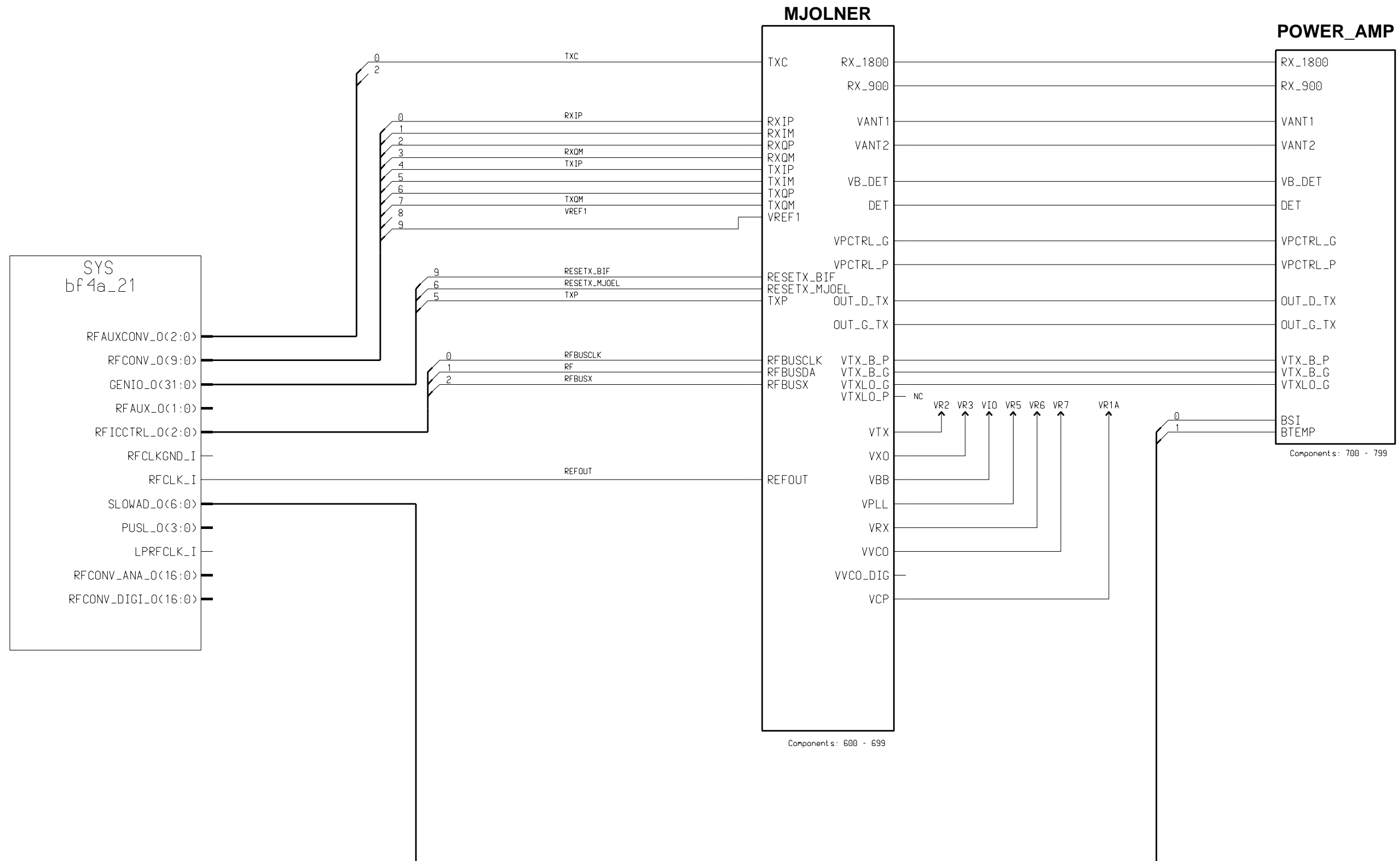

Mjoelner

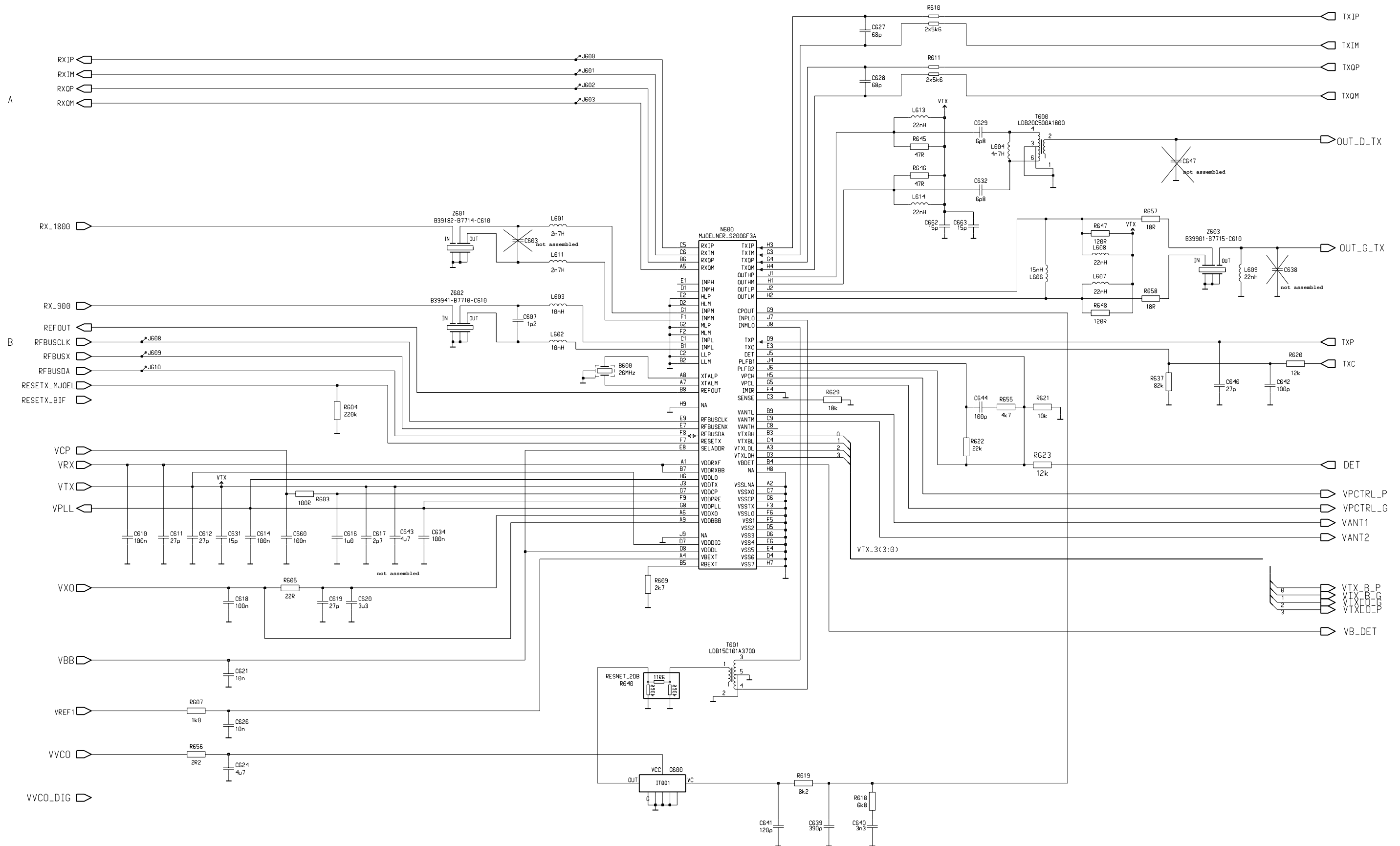

24:33

D

# Power Amplifier

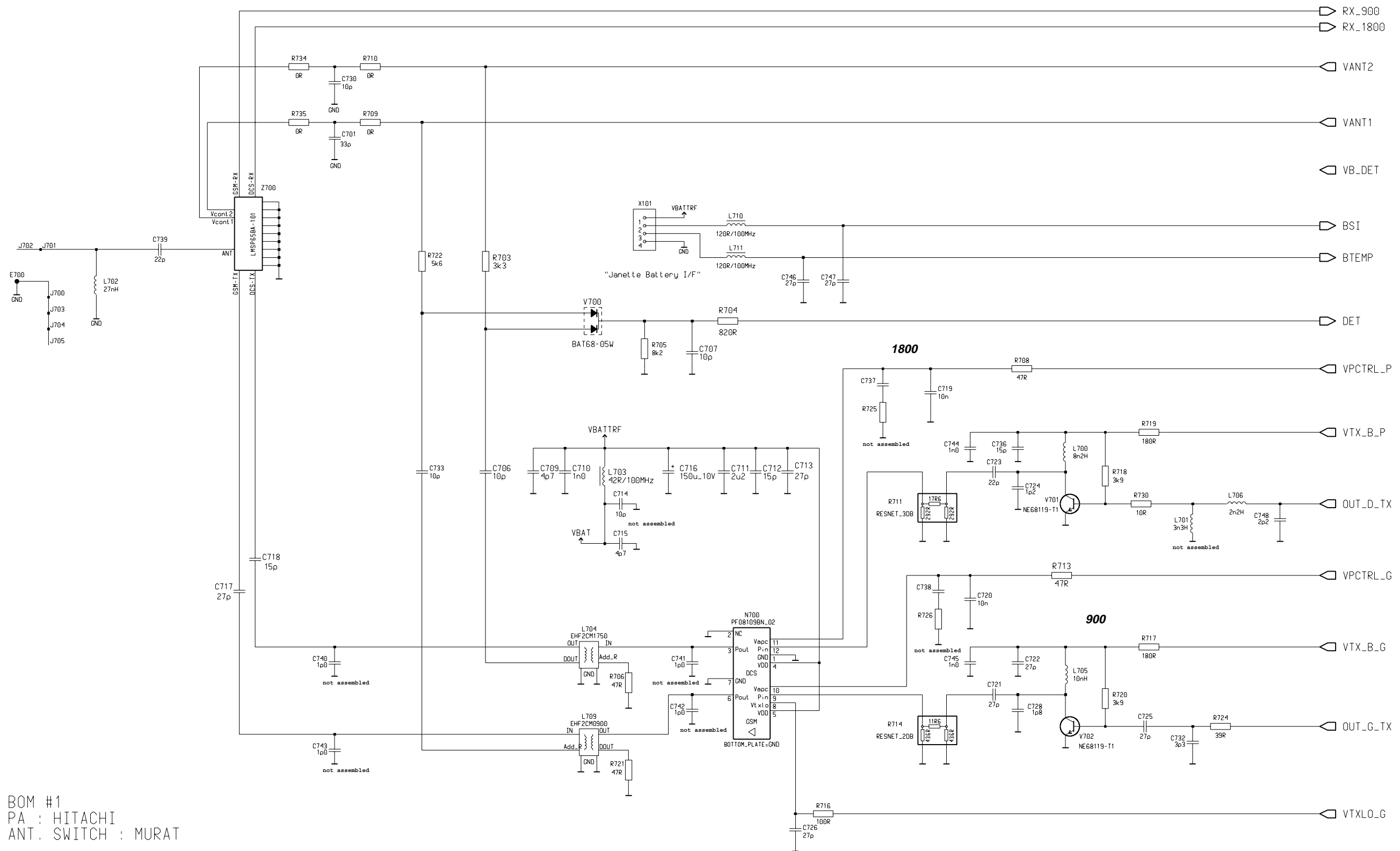

BOM #1  
 PA : HITACHI  
 ANT. SWITCH : MURAT

System

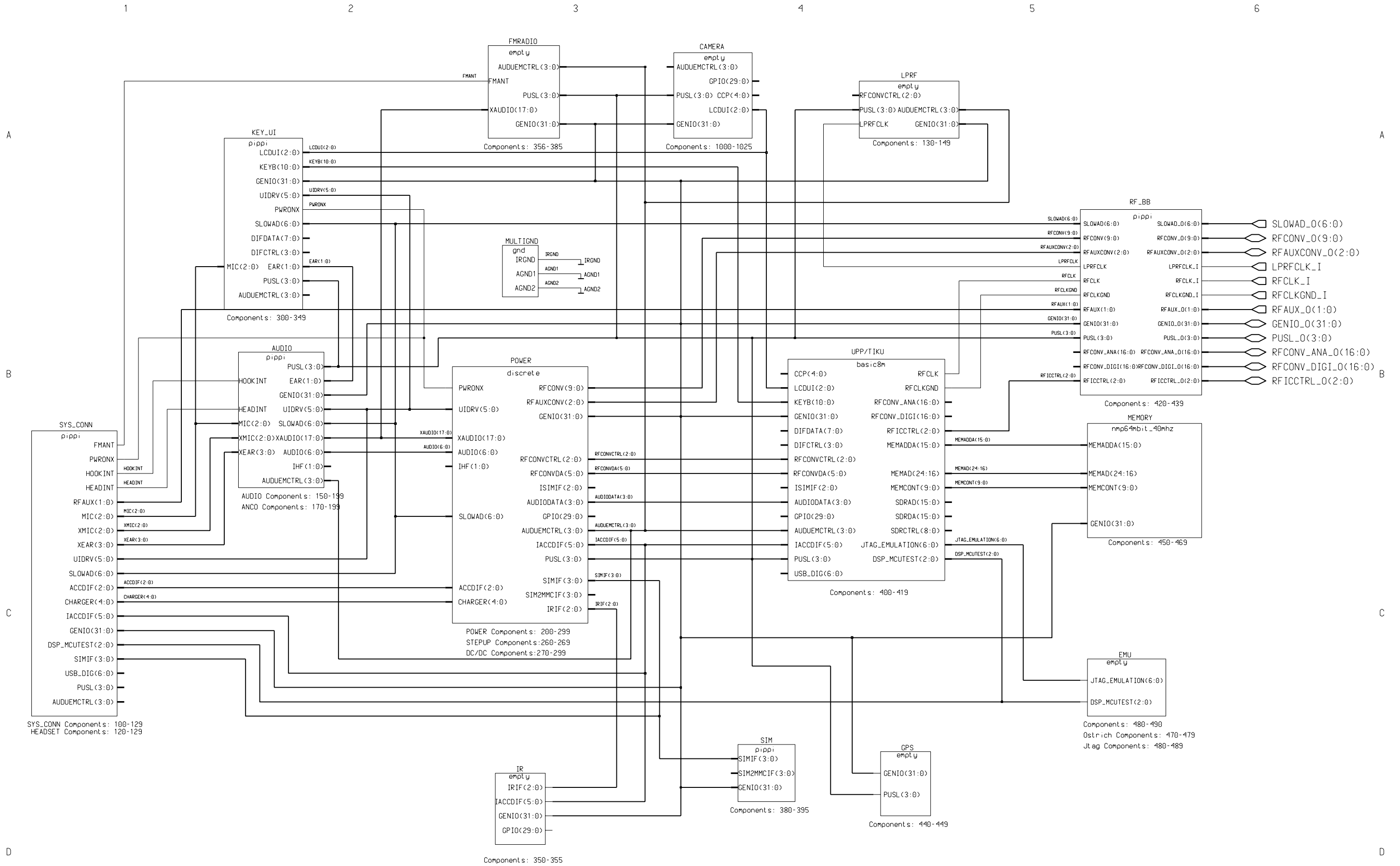

# Audio Interface

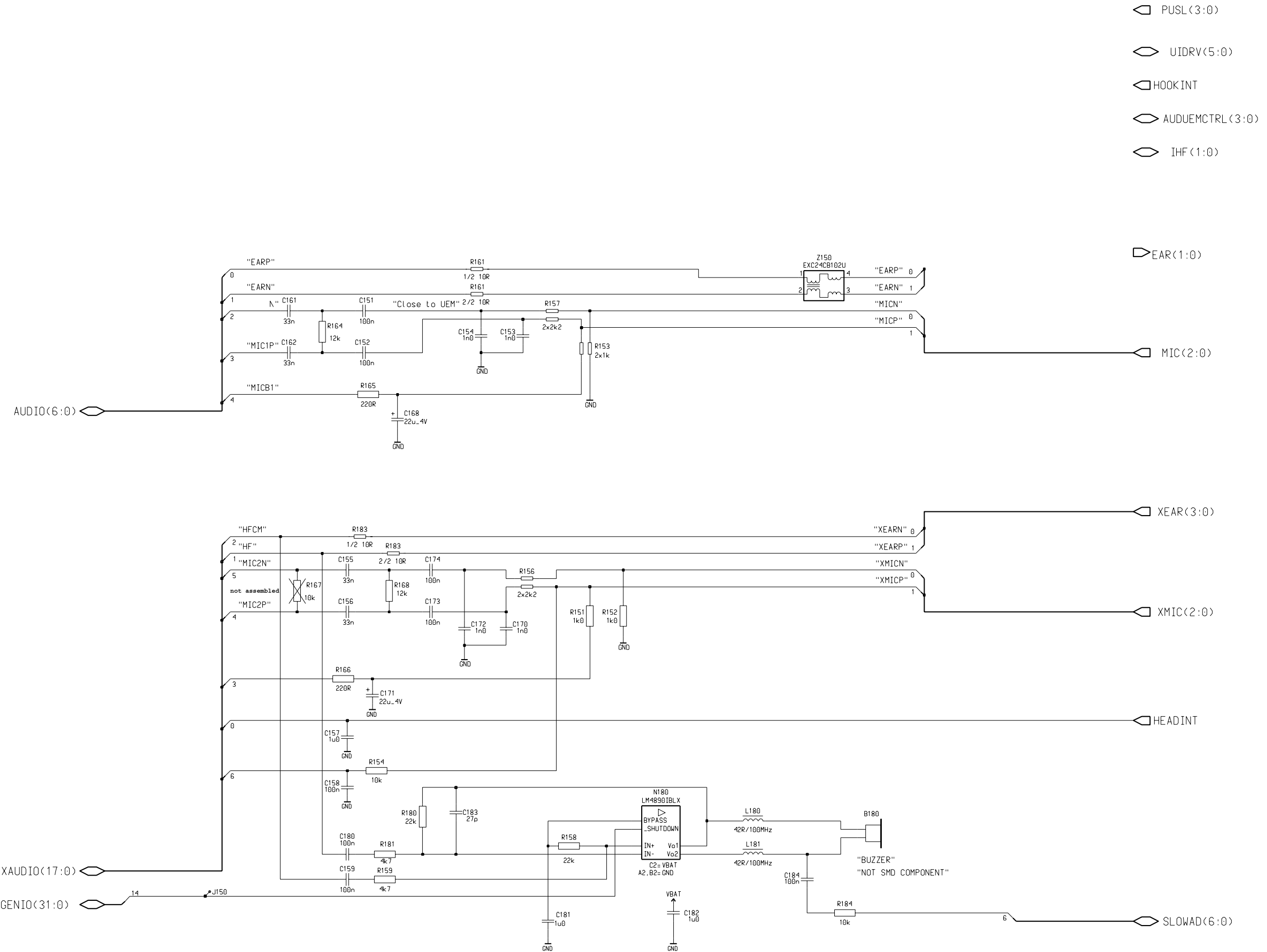

# Key User Interface

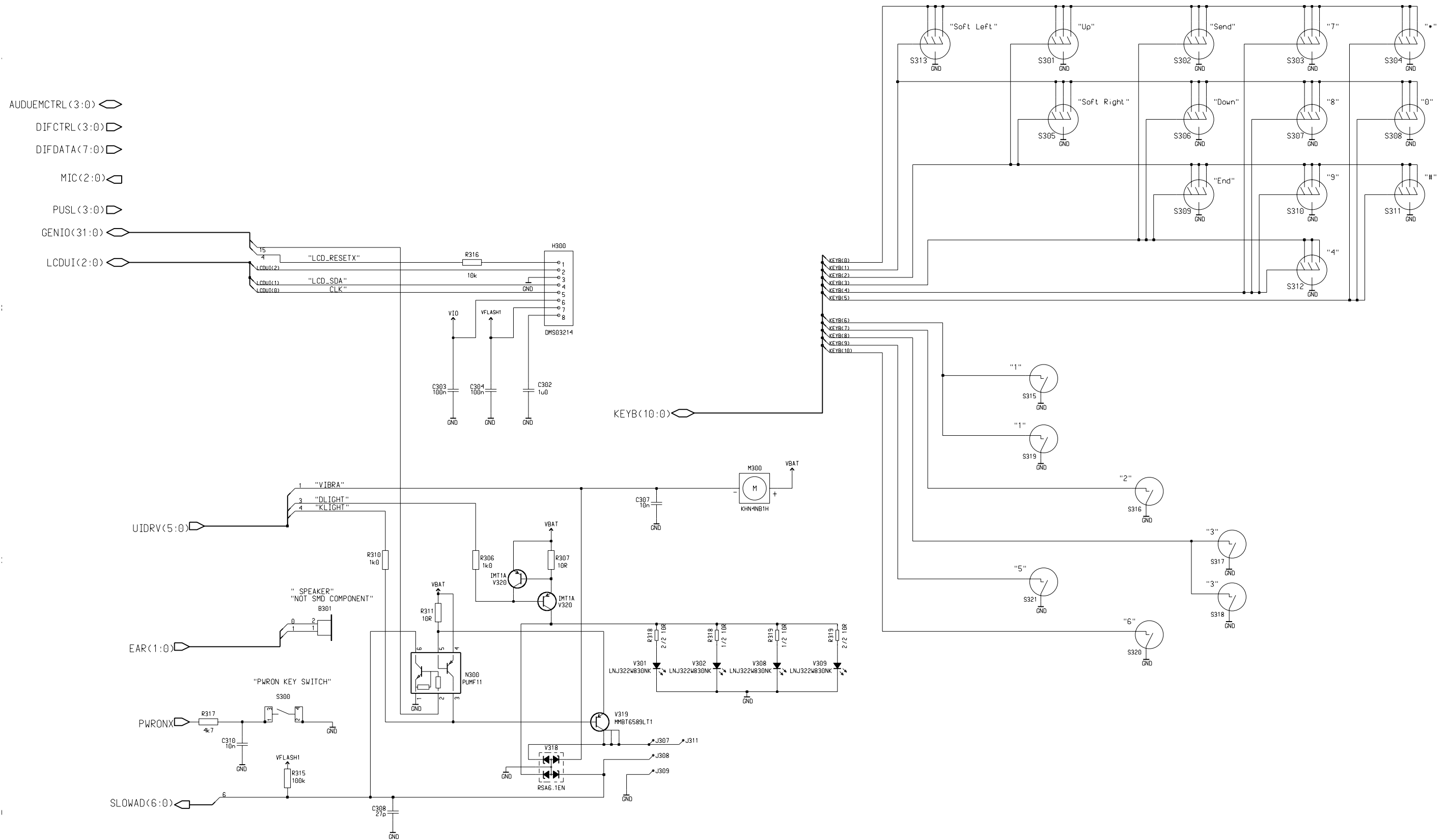

# Flash Memory

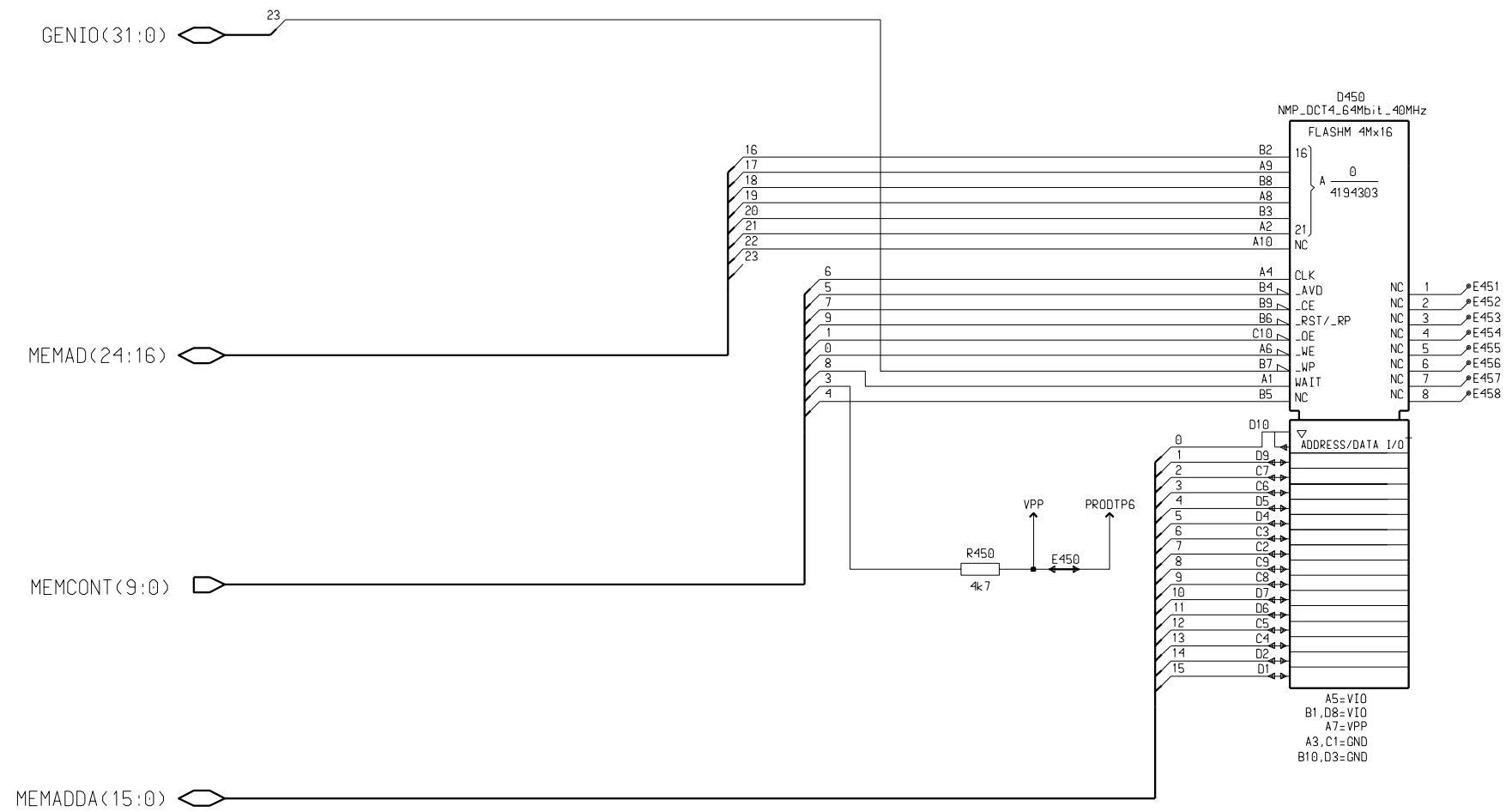
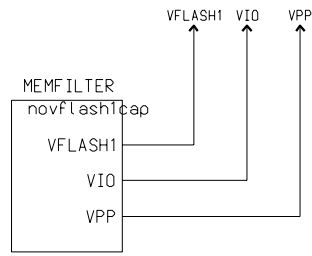

# Memory filter

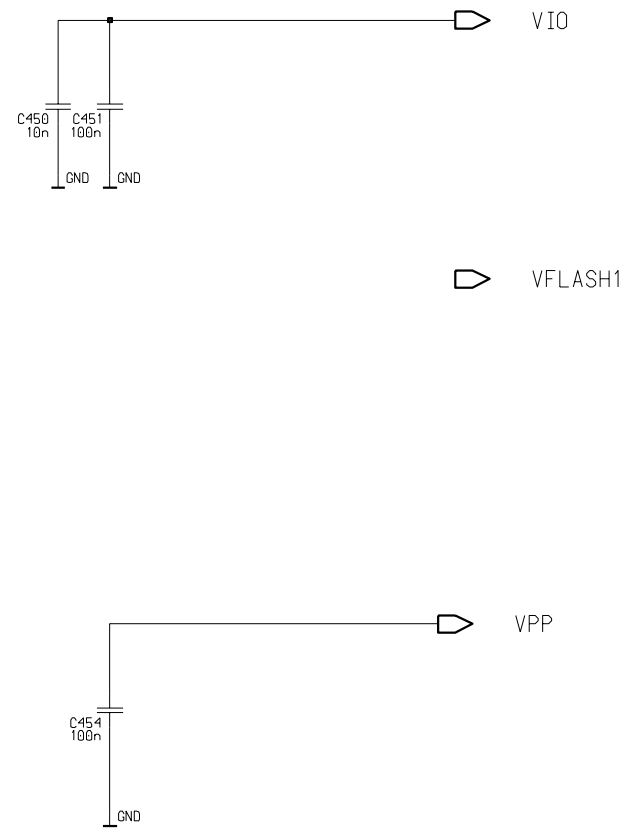



# System - Discrete Power Mangement

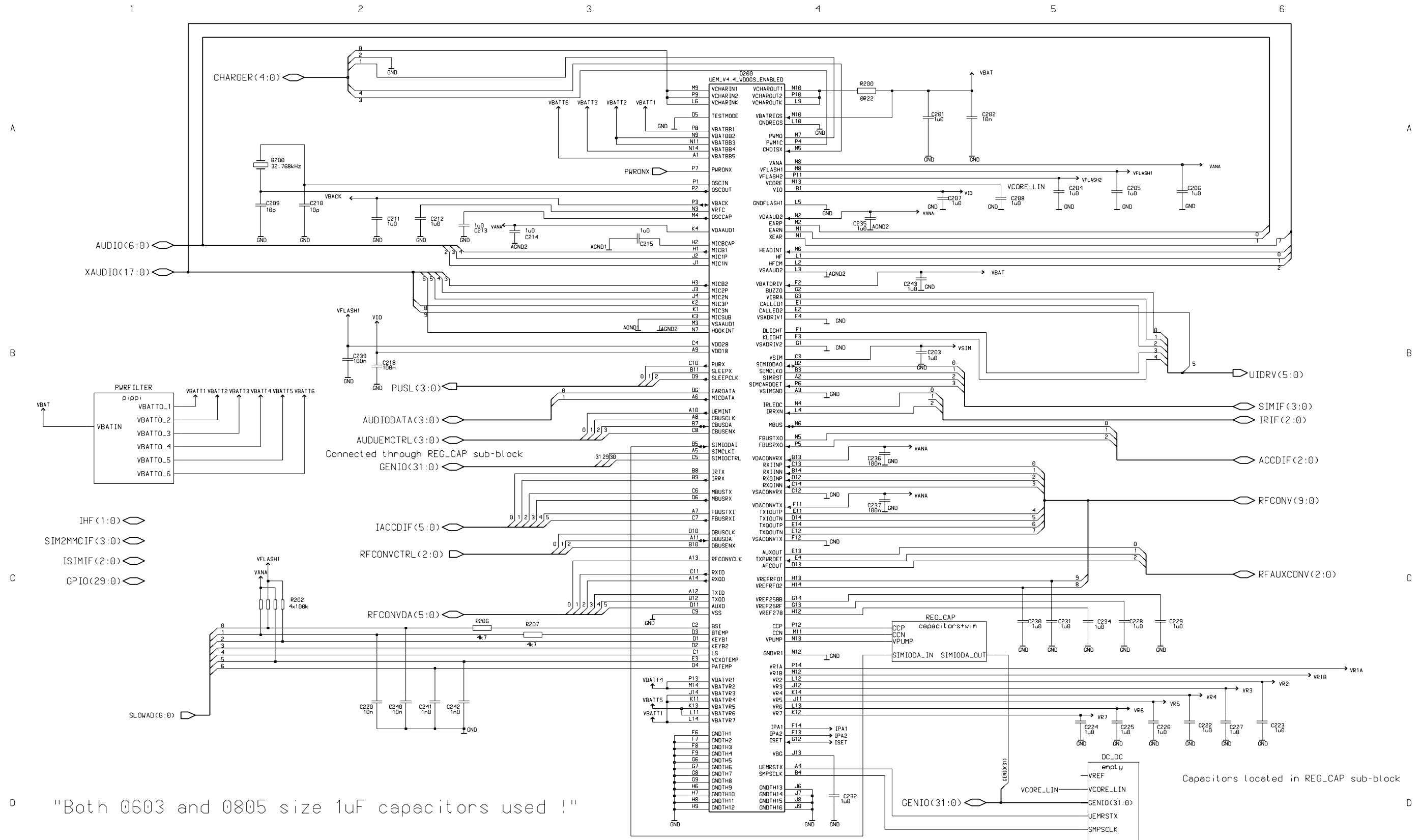

"Both 0603 and 0805 size 1uF capacitors used !"

Used refs in REG\_CAP: C238, C200, C219, C233, C221 and R205

24:33

# UEM Power filter

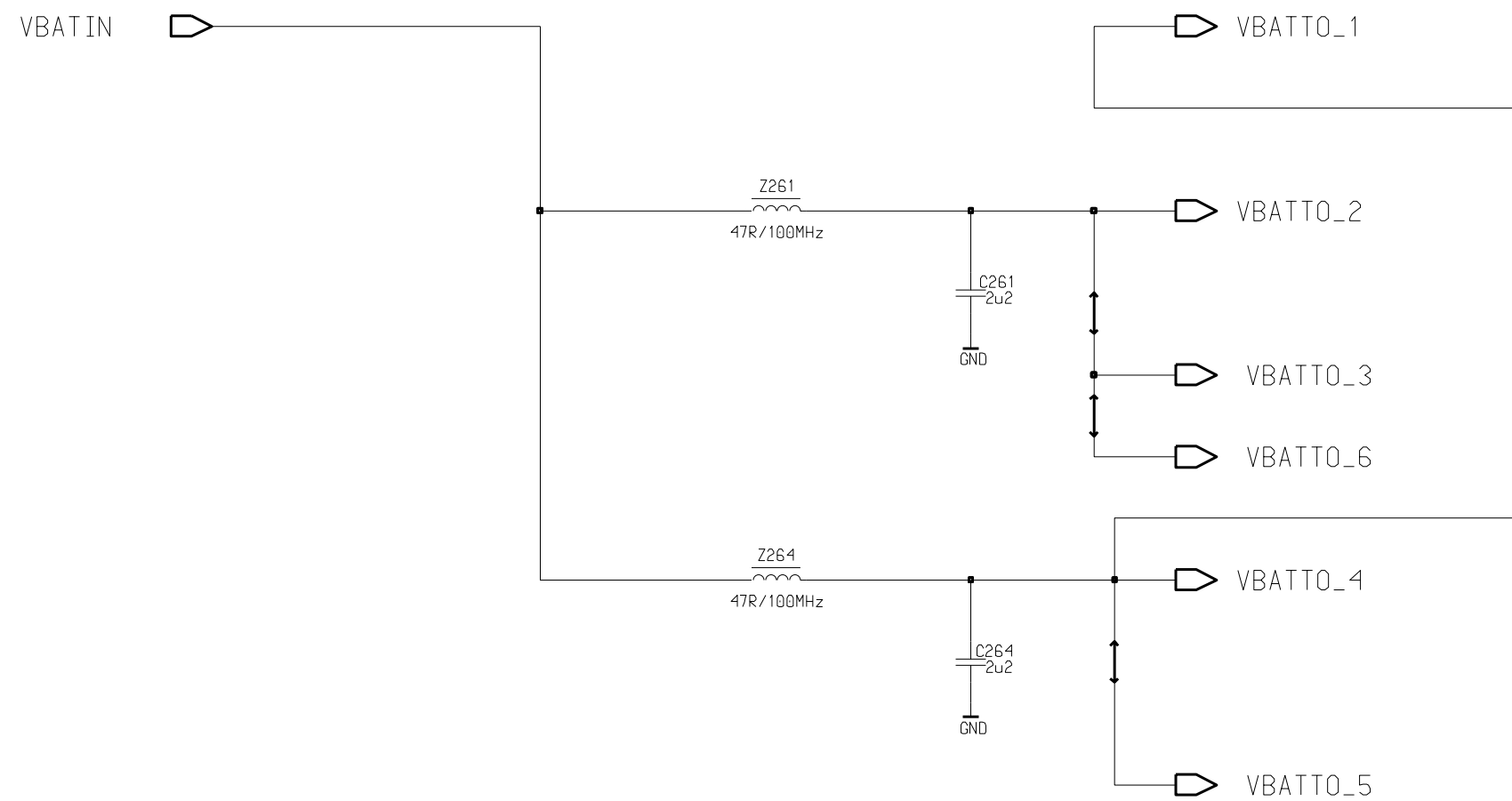

# Charge Pump Capacitors

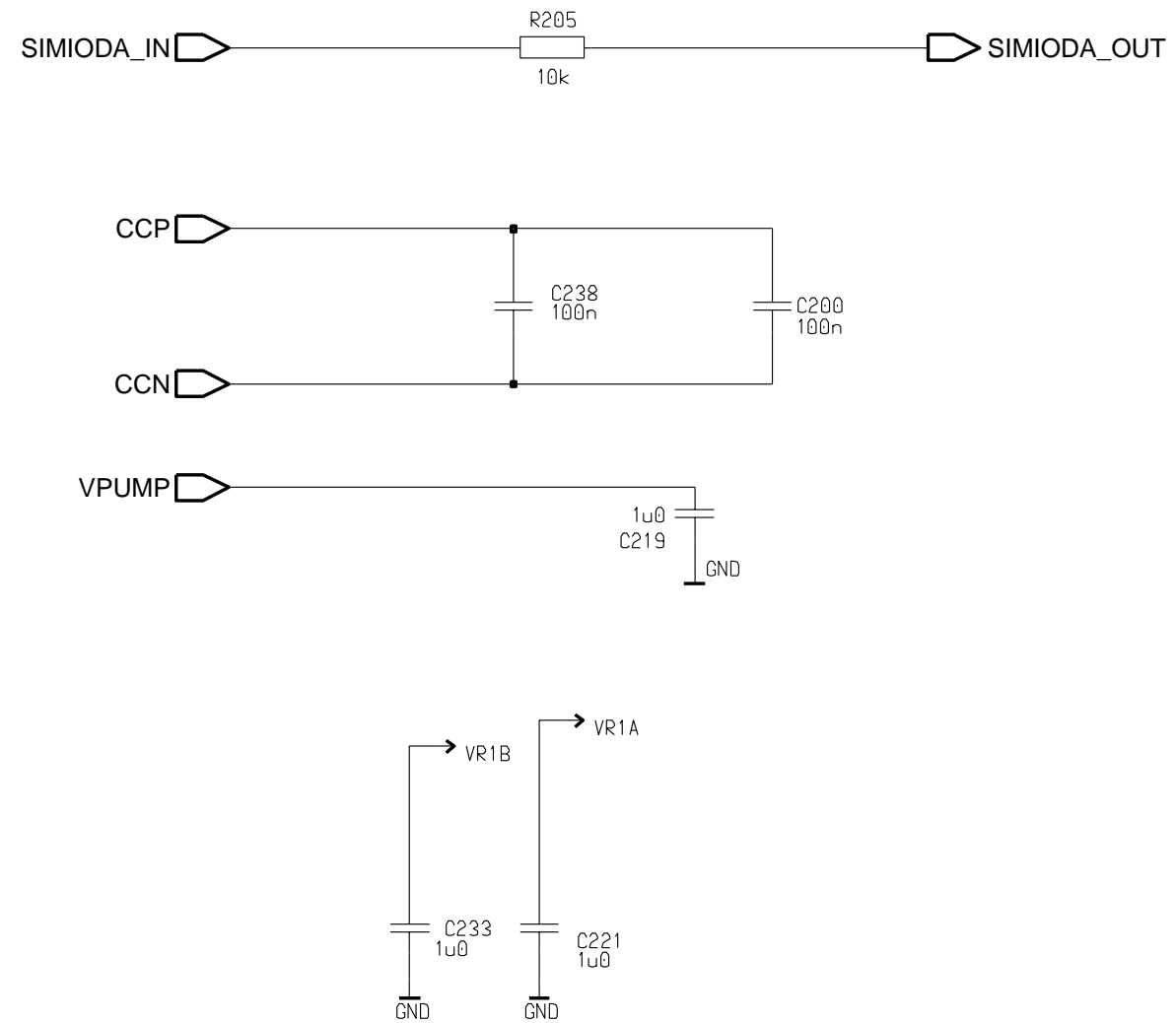

RF - BB Interface

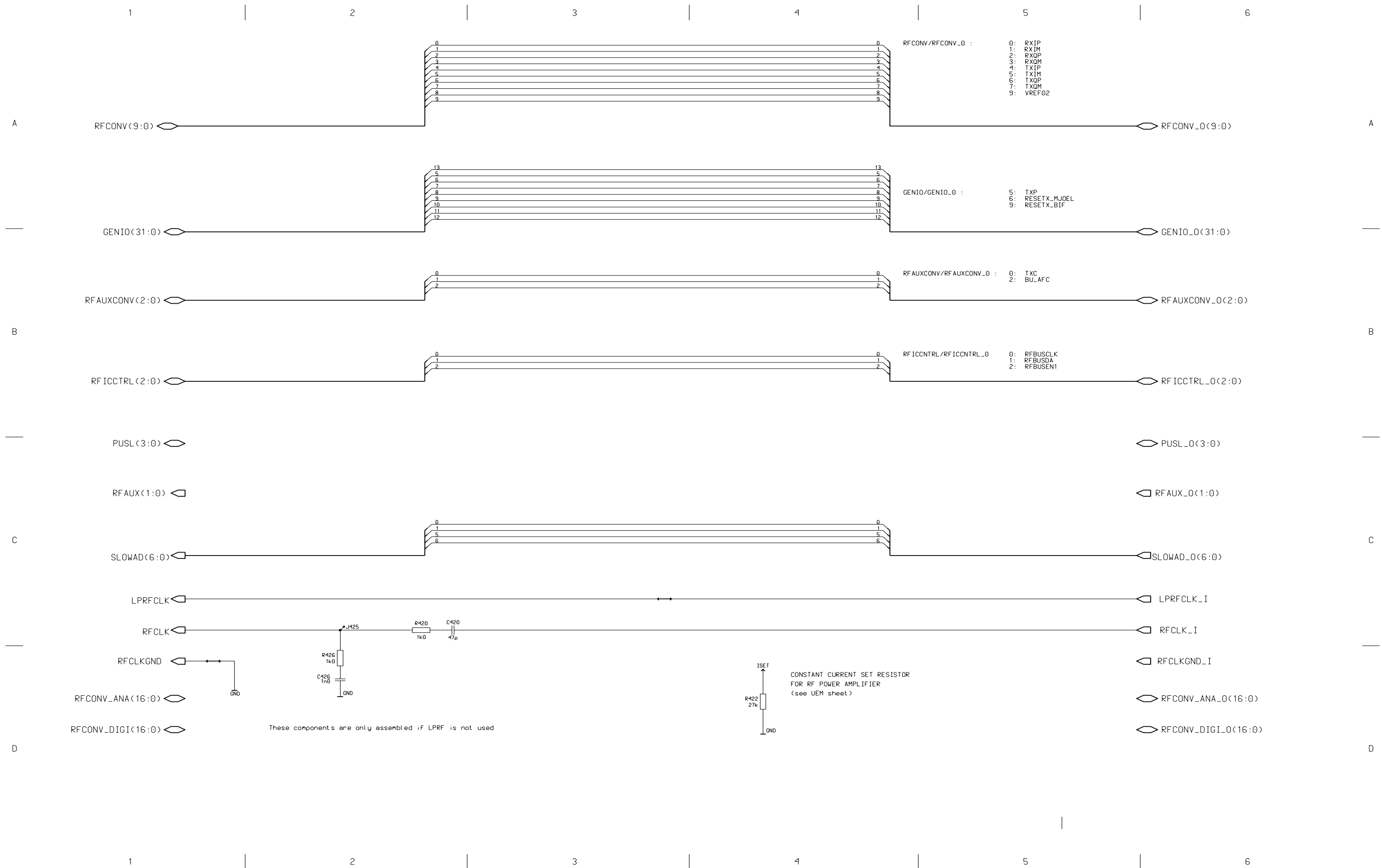

24:33

SIM Reader

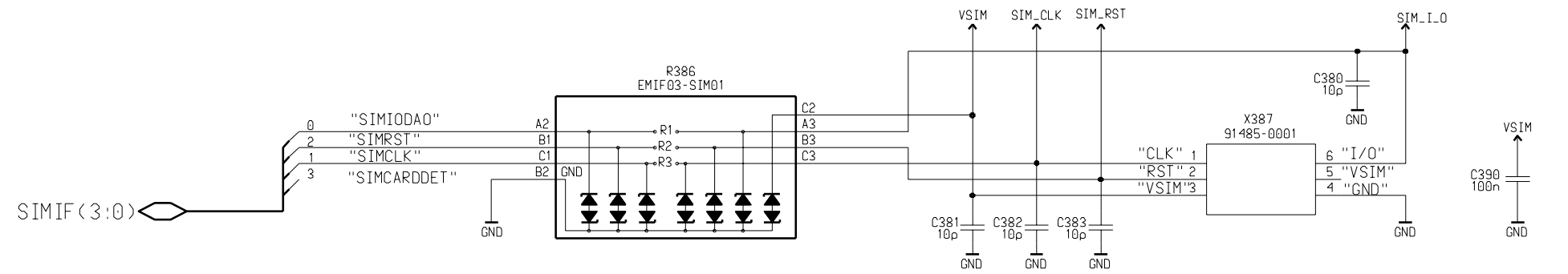

X38	
CLK	I/O
RST	VCC
VCC	GND

# System Connector

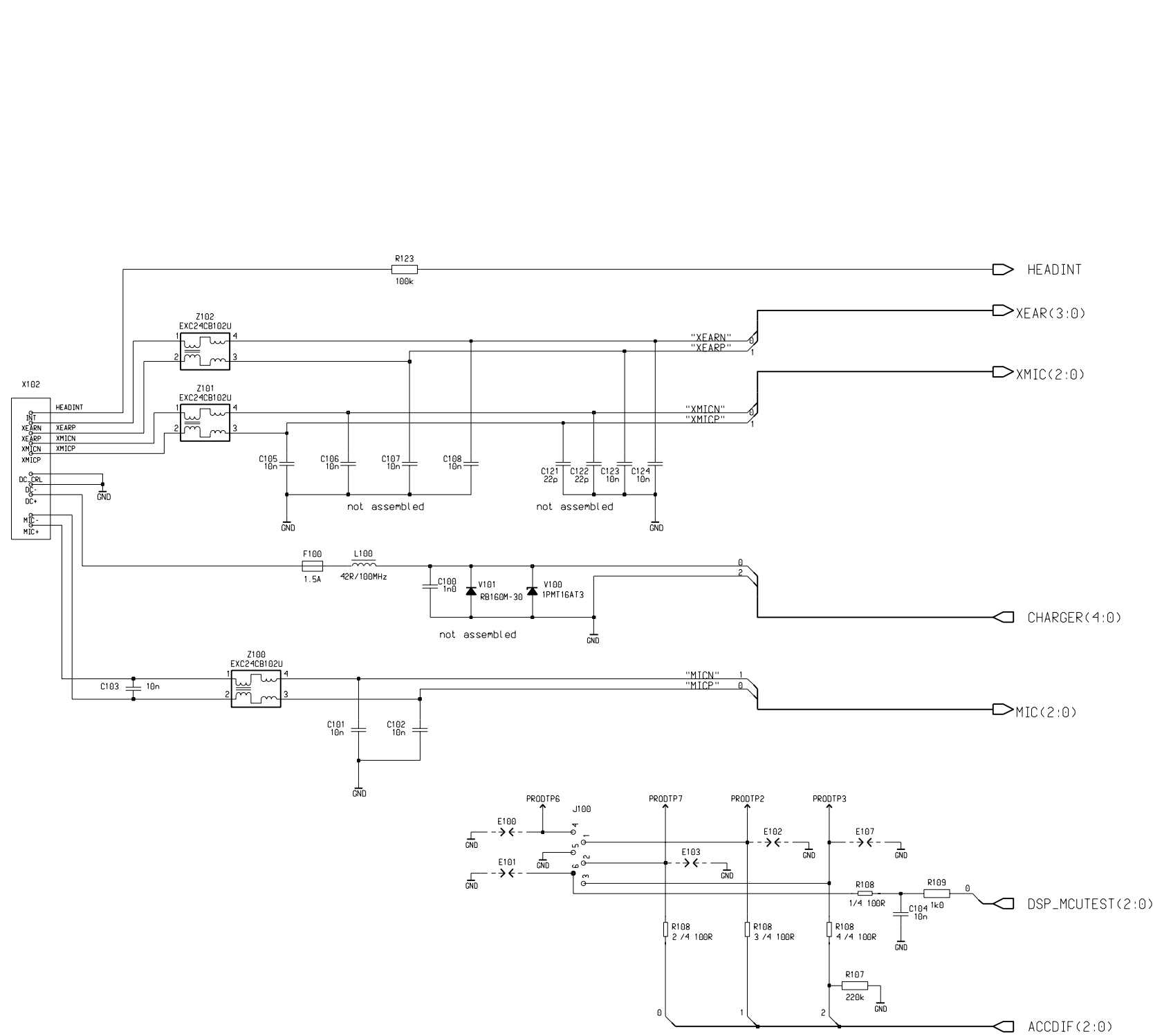

- ◁ UIDRV(5:0)
- ◁ IACCDIF(5:0)
- ◁ RFAUX(1:0)
- ▷ PWRONX
- ◁ SIMIF(3:0)
- ▷ HOOKINT
- ◁ GENIO(31:0)
- ▷ FMANT
- ▷ SLOWAD(6:0)
- ◁ USB\_DIG(6:0)
- ◁ PUSL(3:0)
- ◁ AUDUEMCTRL(3:0)

UPP

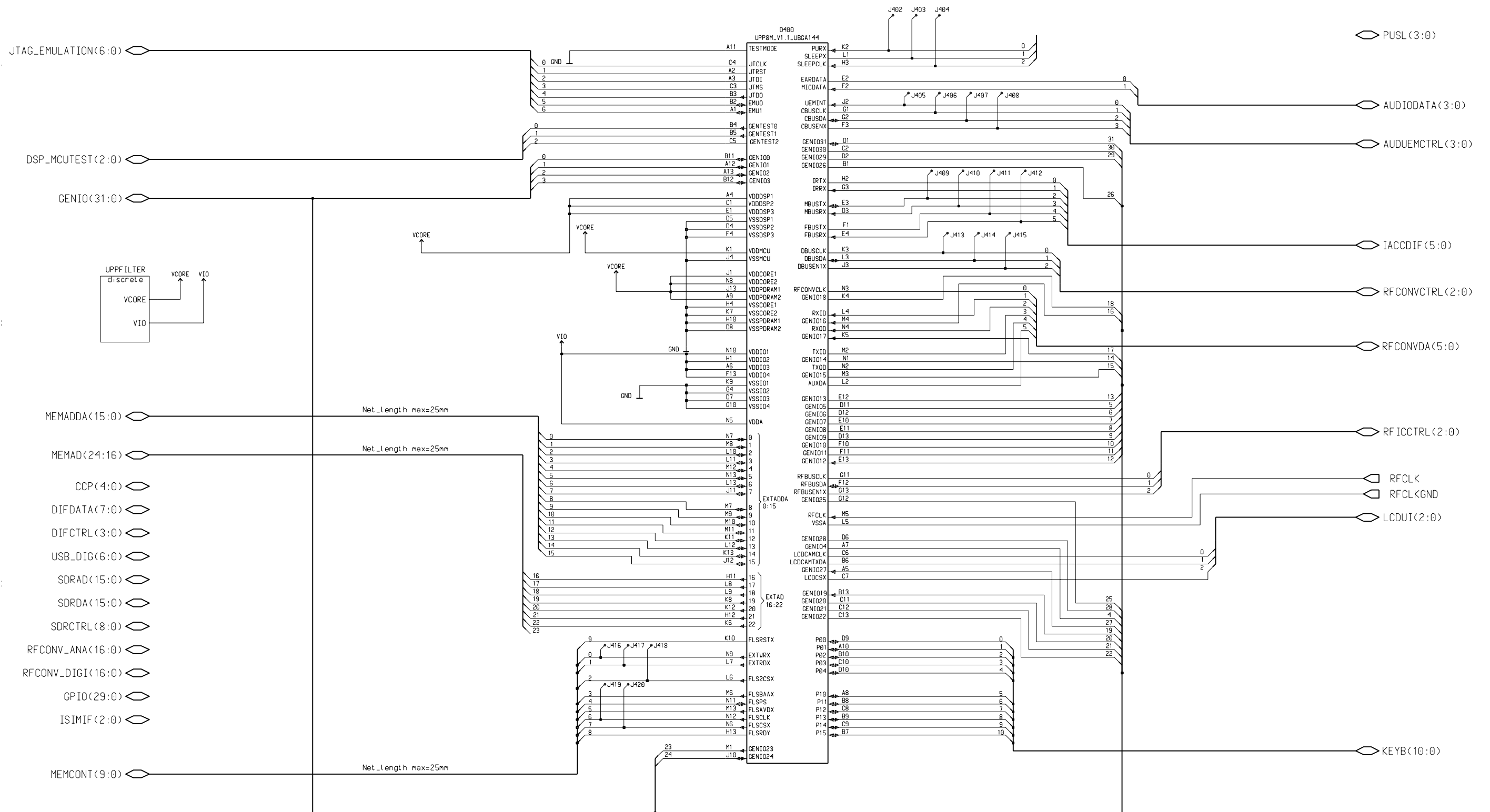

# Discrete decoupling capacitors

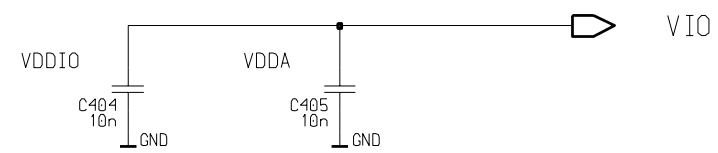
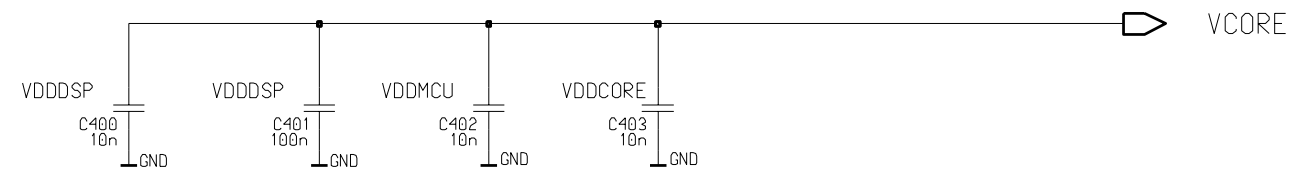



# Layout Diagram of BF4A - Top

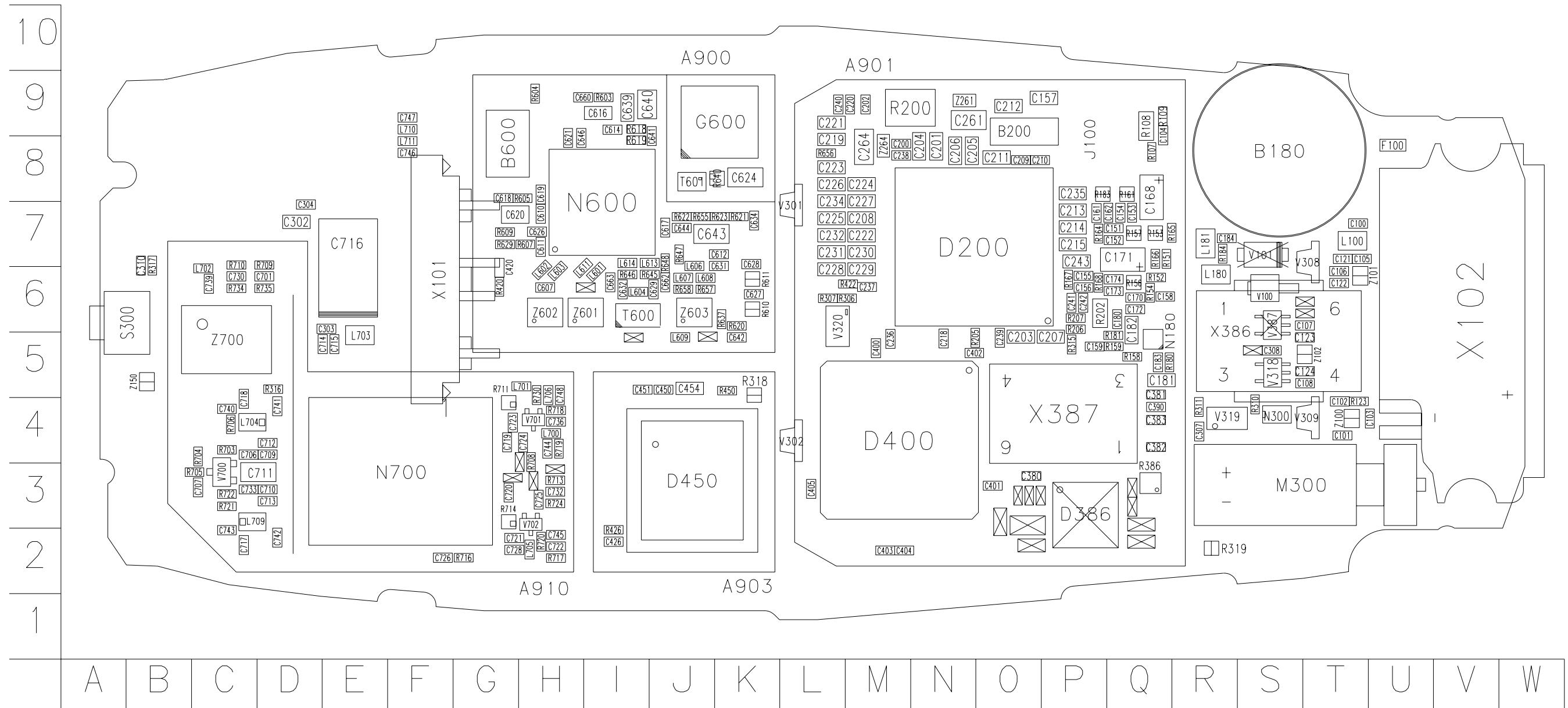

# Layout Diagram of BF4A - Bottom

