

# Block Diagram of Baseband (Version: 3.5 ; Edit : 167) for layout version 15

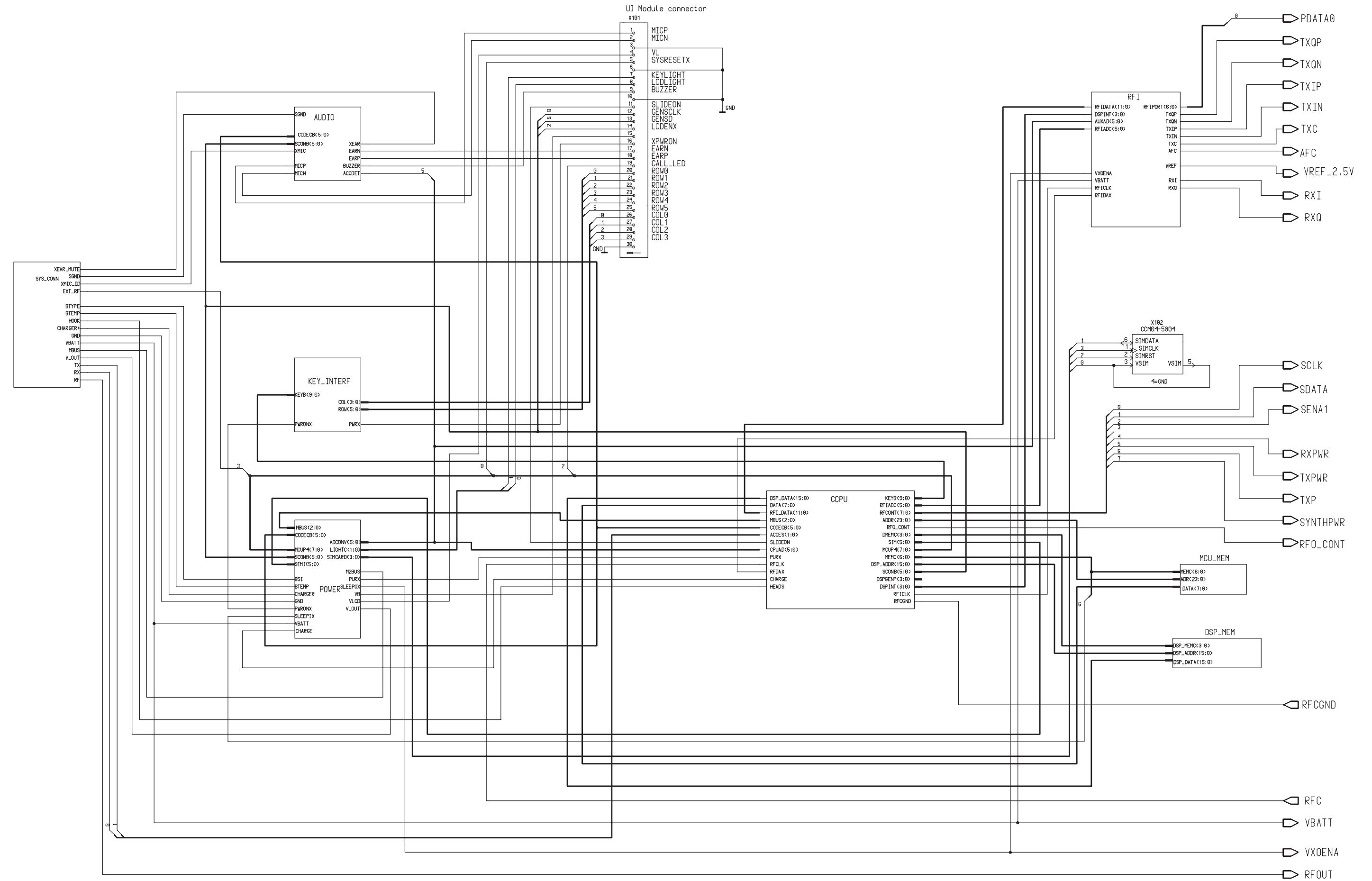

# Circuit Diagram of Power Supply & Charging (Version: 3.5 ; Edit:126) for layout version 15

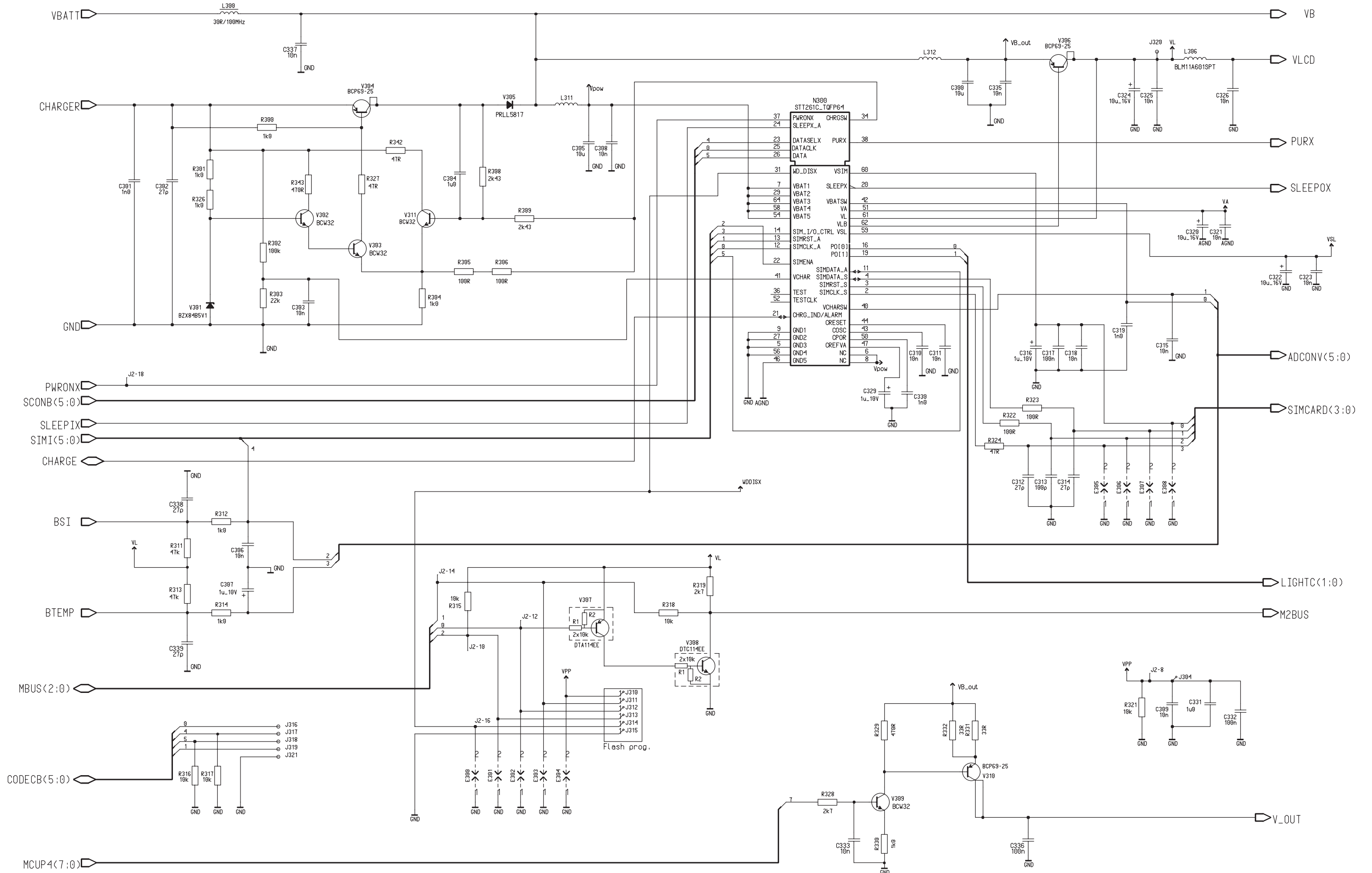

# Circuit Diagram of Central Processing Unit (Version: 3.5 ; Edit 145) for layout version 15

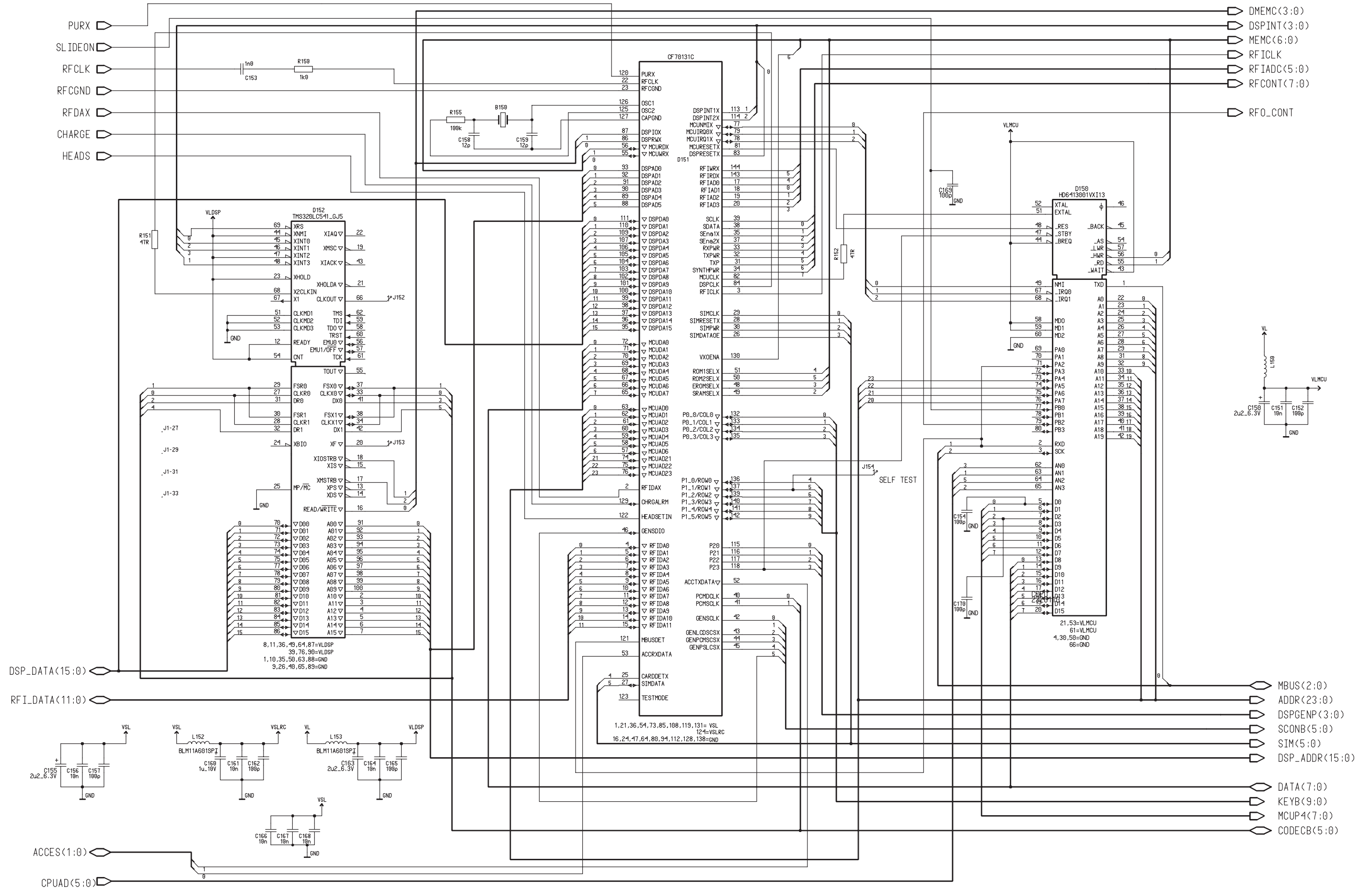

# Circuit Diagram of MCU Memory Block (Version: 3.5 ; Edit 53) for layout version 15

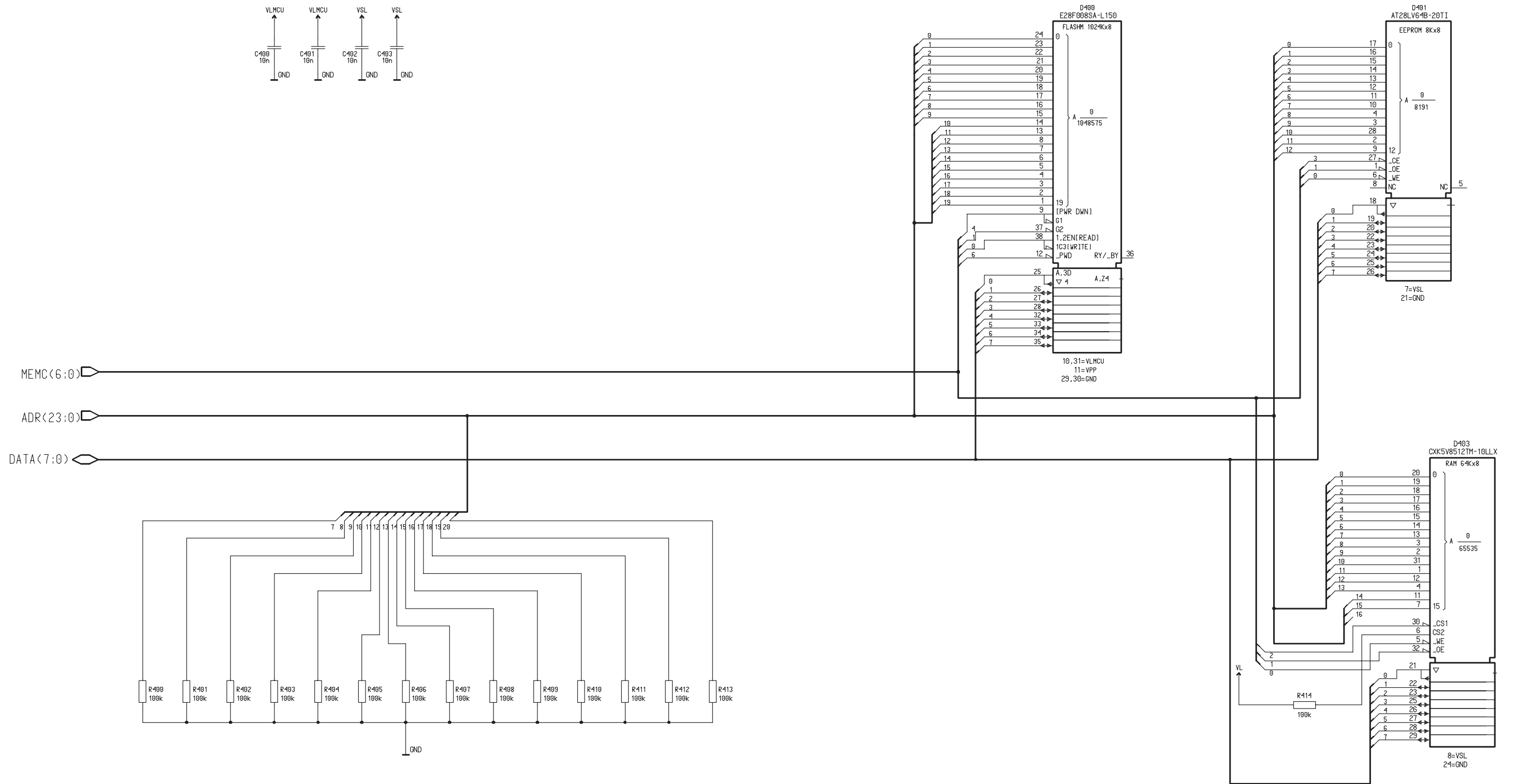

# Circuit Diagram of Keyboard and Display Interface (Version: 3.5 ; Edit 45) for layout version 15

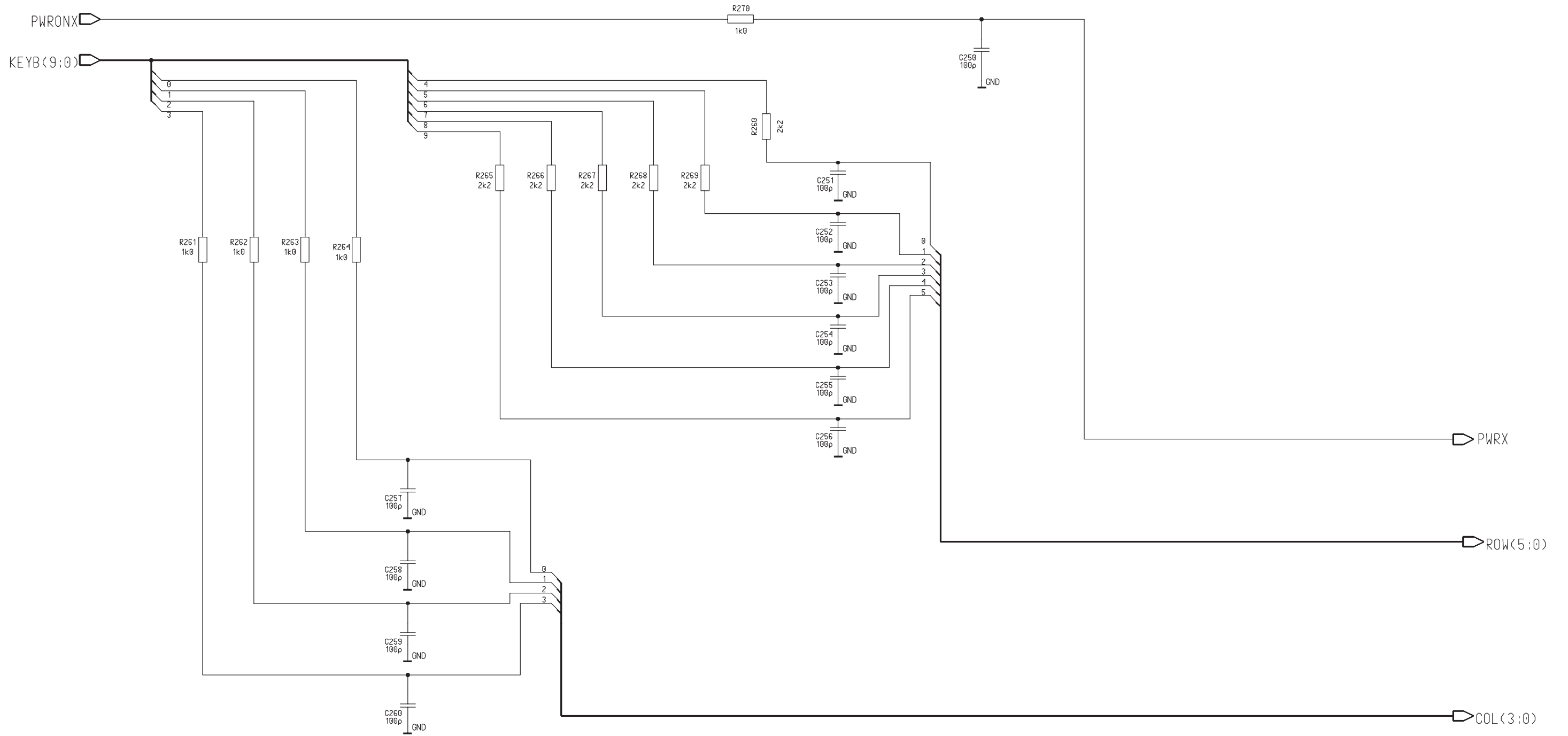



### Circuit Diagram of DSP Memory Block (Version: 3.5 ; Edit 45) for layout version 15

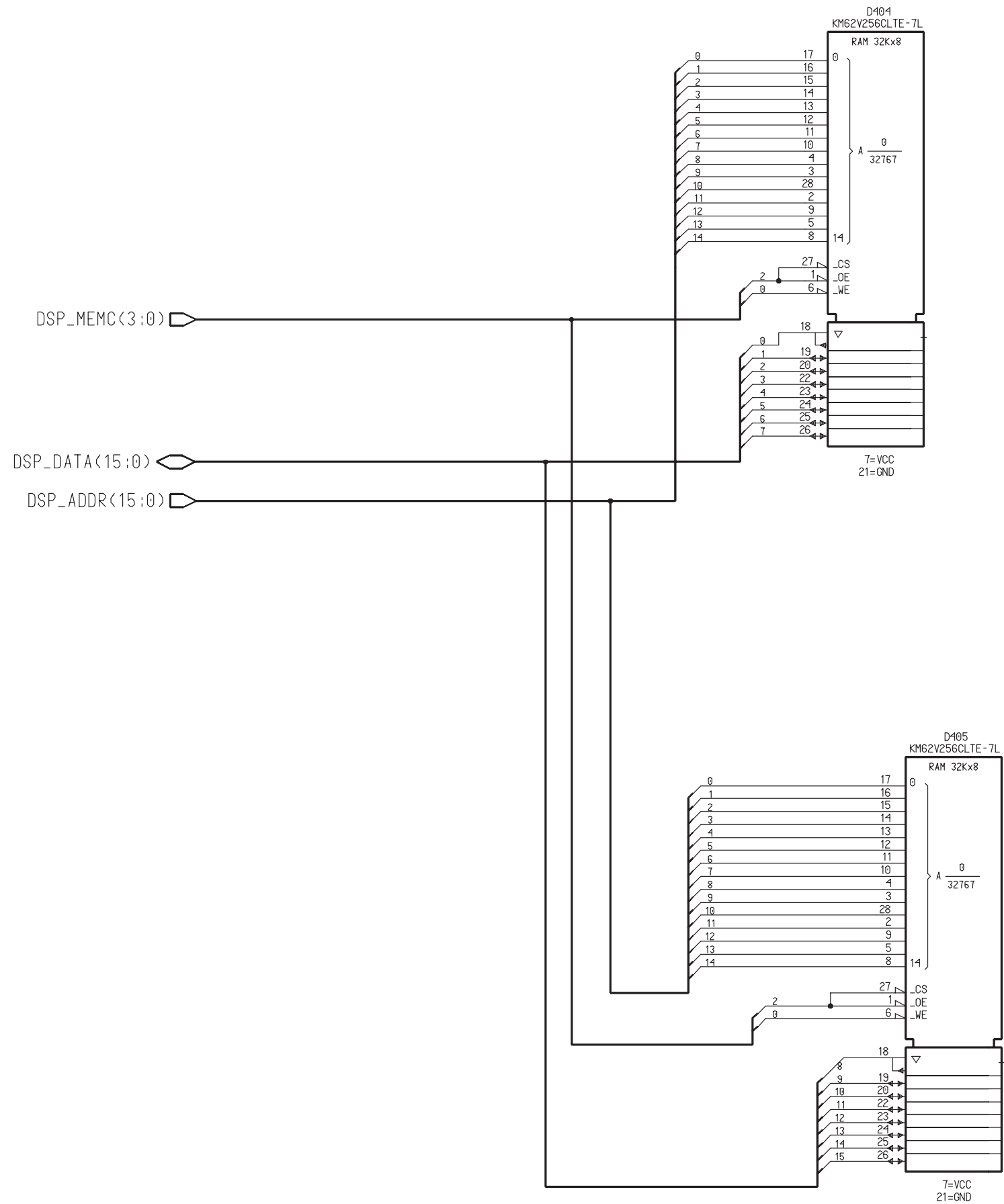
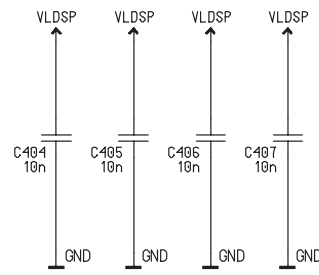

# Circuit Diagram of RFI (Version: 3.5 ; Edit 92) for layout version 15

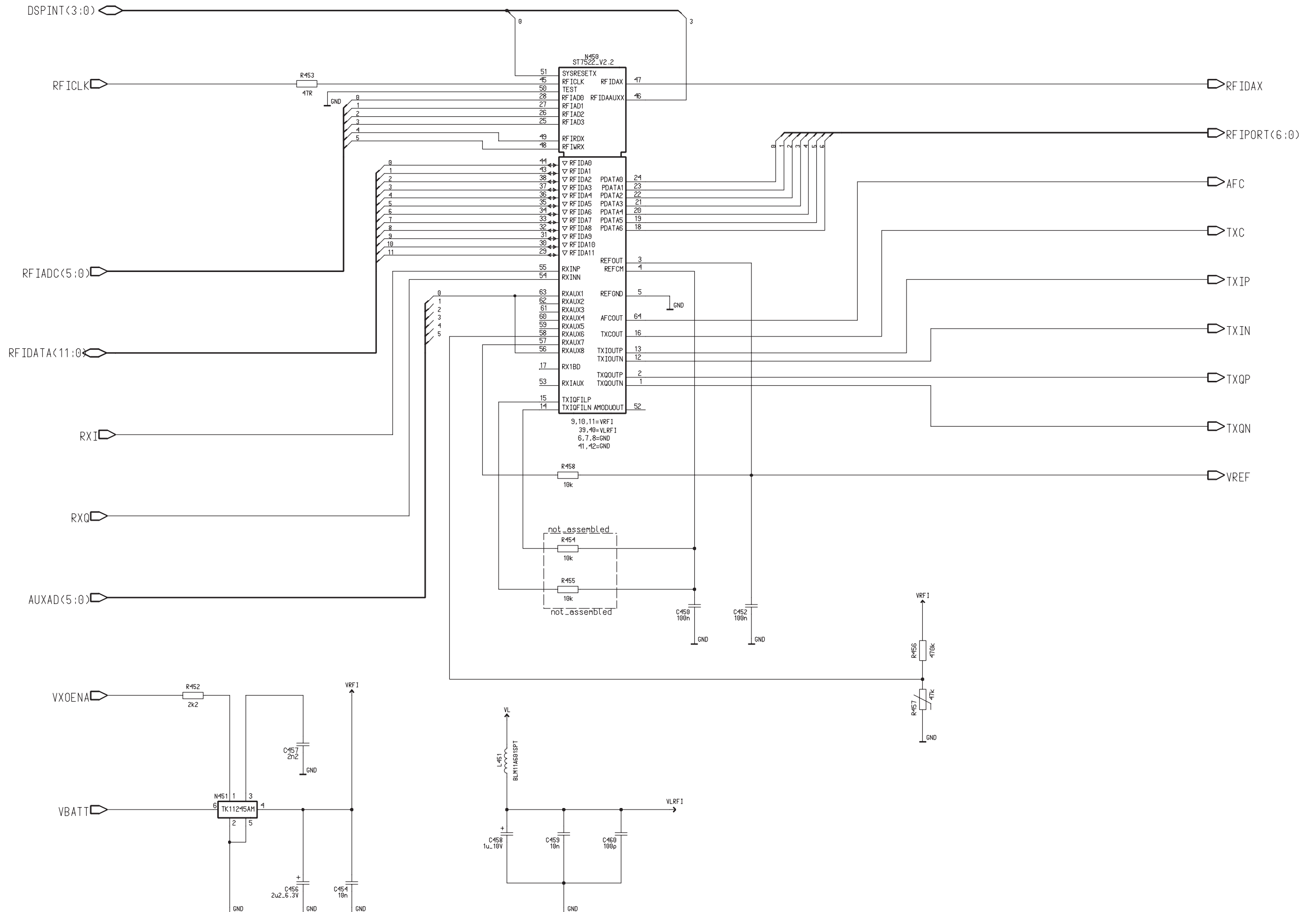





# Circuit Diagram of Transmitter (Version: J4.2 ; Edit 350) for layout version 15

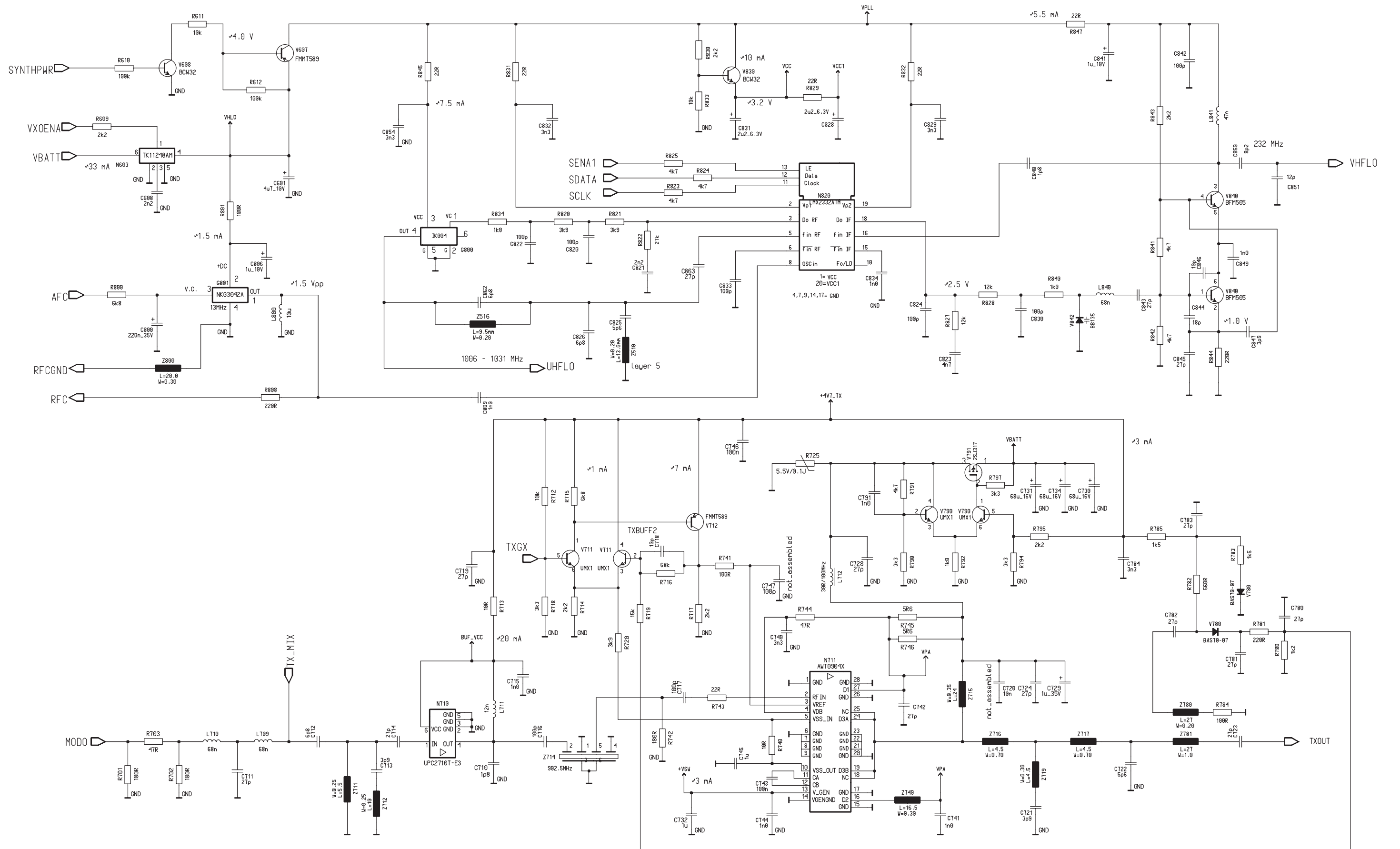

# Circuit Diagram of System Connector (Version: 3.5 ; Edit 94) for layout version 15

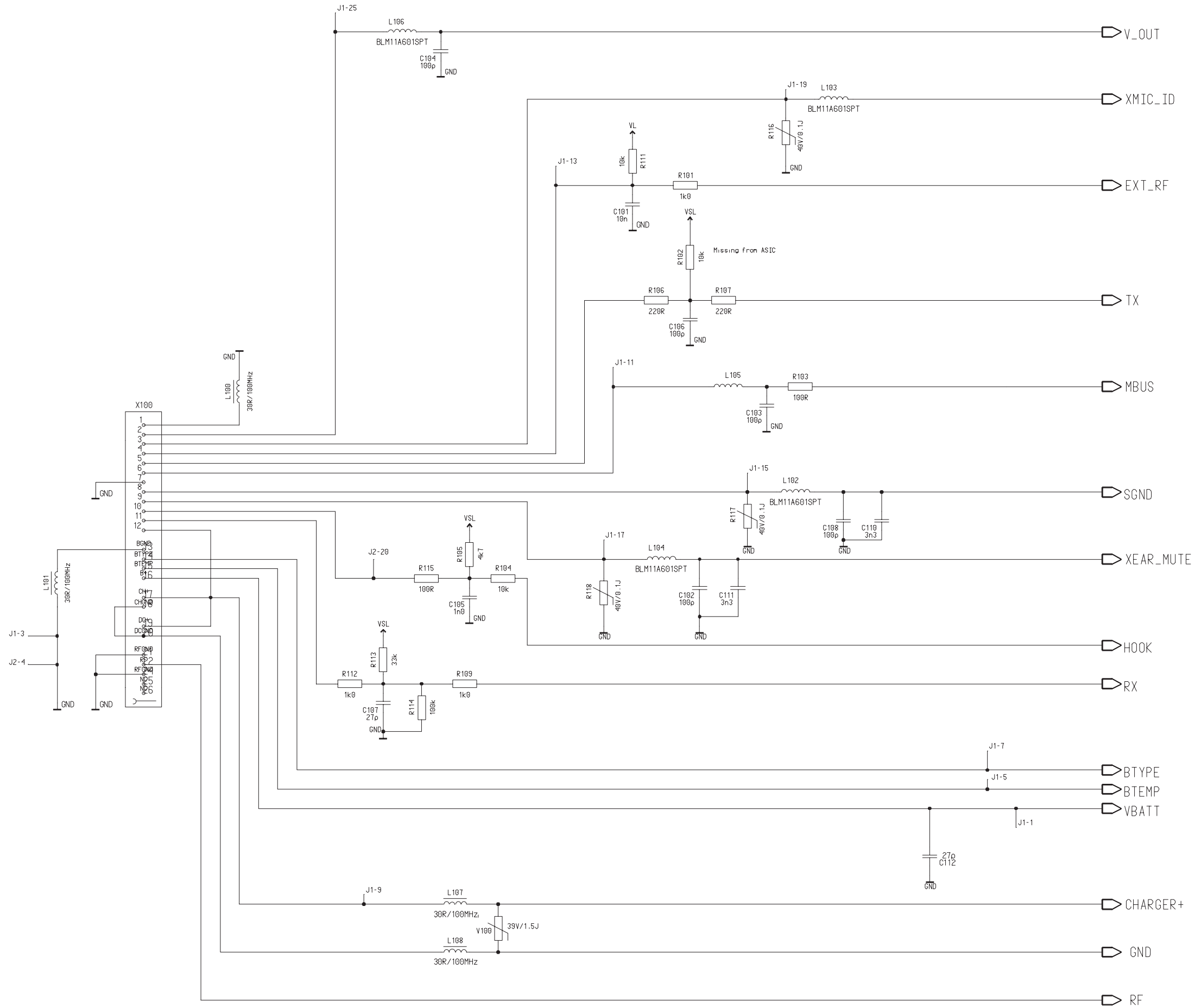



# Block Diagram of Baseband (GJ8A) (Version: 3.5 ; Edit : 169) for layout version 02

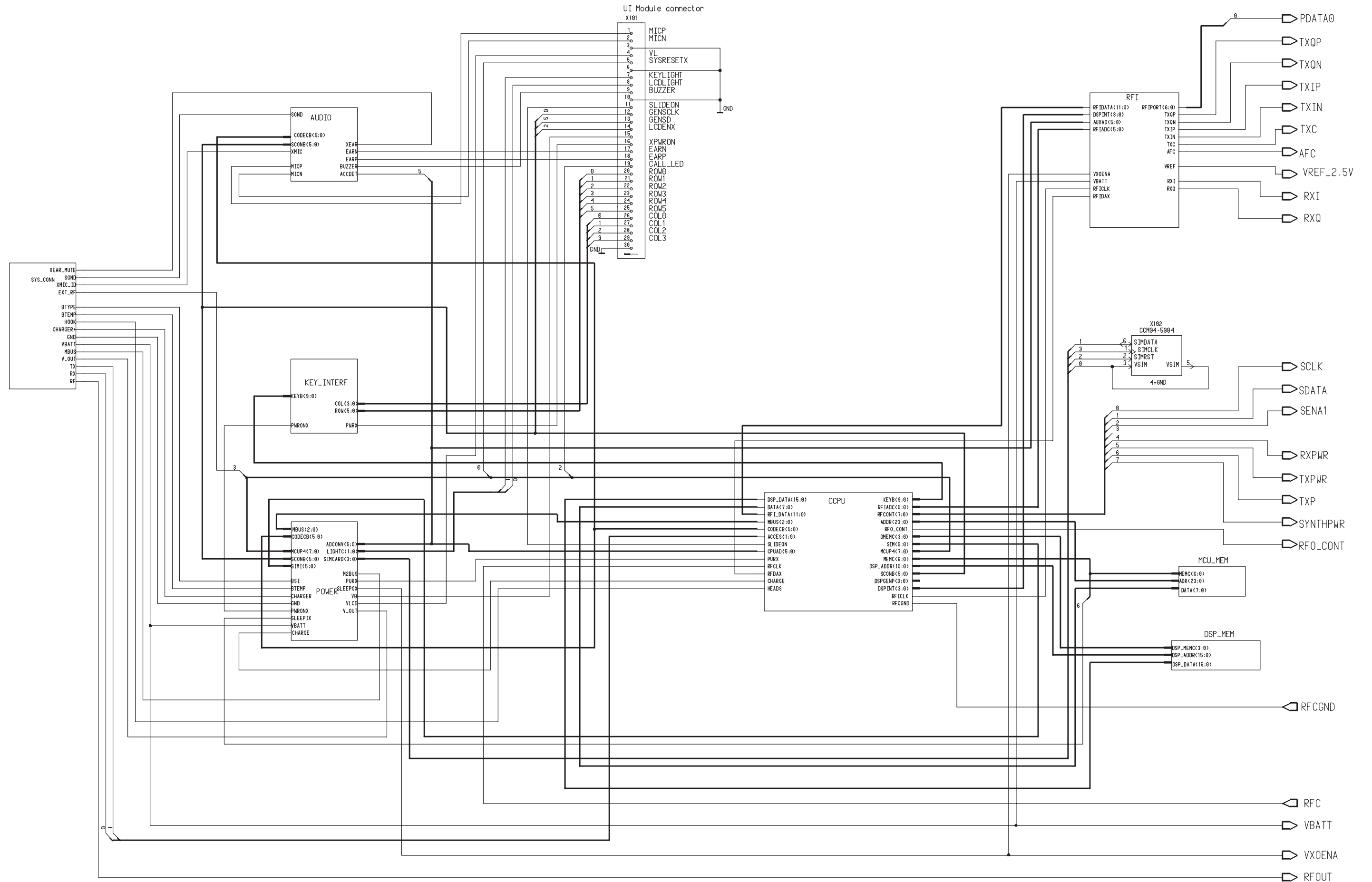

# Circuit Diagram of Power Supply & Charging (GJ8A) (Version: 3.5 ; Edit:127) for layout version 02

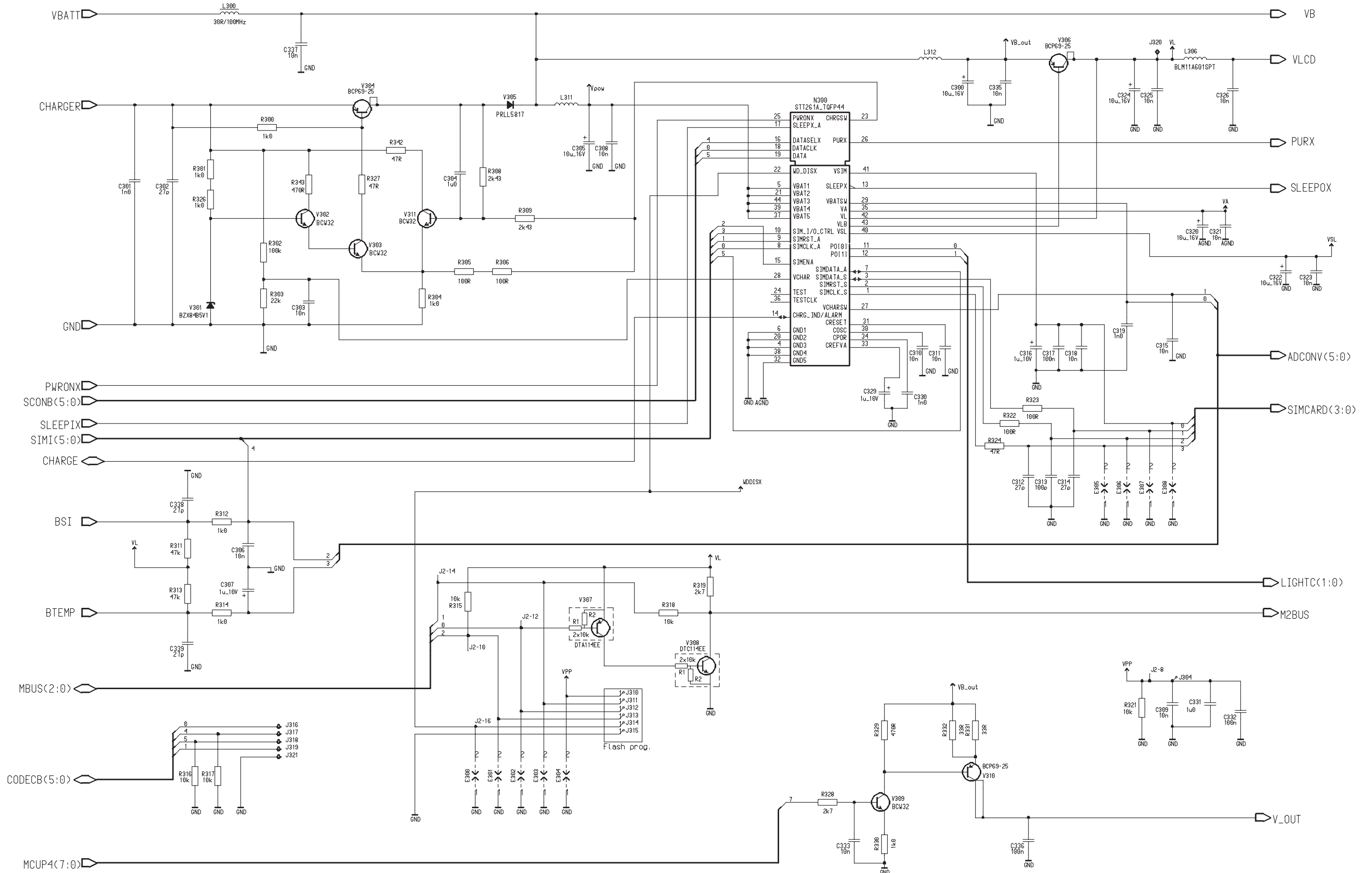

# Circuit Diagram of Central Processing Unit (GJ8A) (Version: 3.5 ; Edit 149) for layout version 02

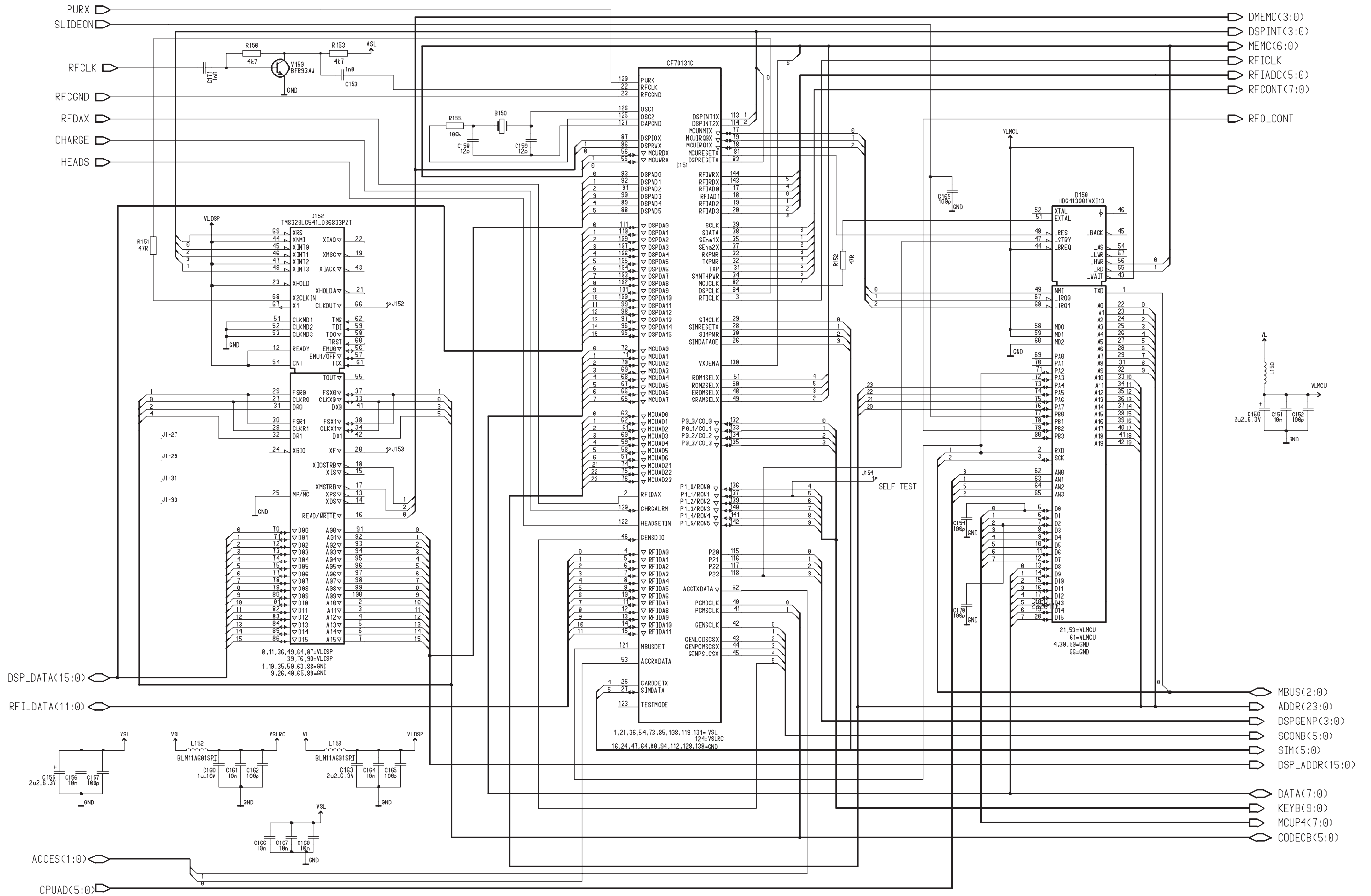



### Circuit Diagram of MCU Memory Block (GJ8A) (Version: 3.5 ; Edit 55) for layout version 02

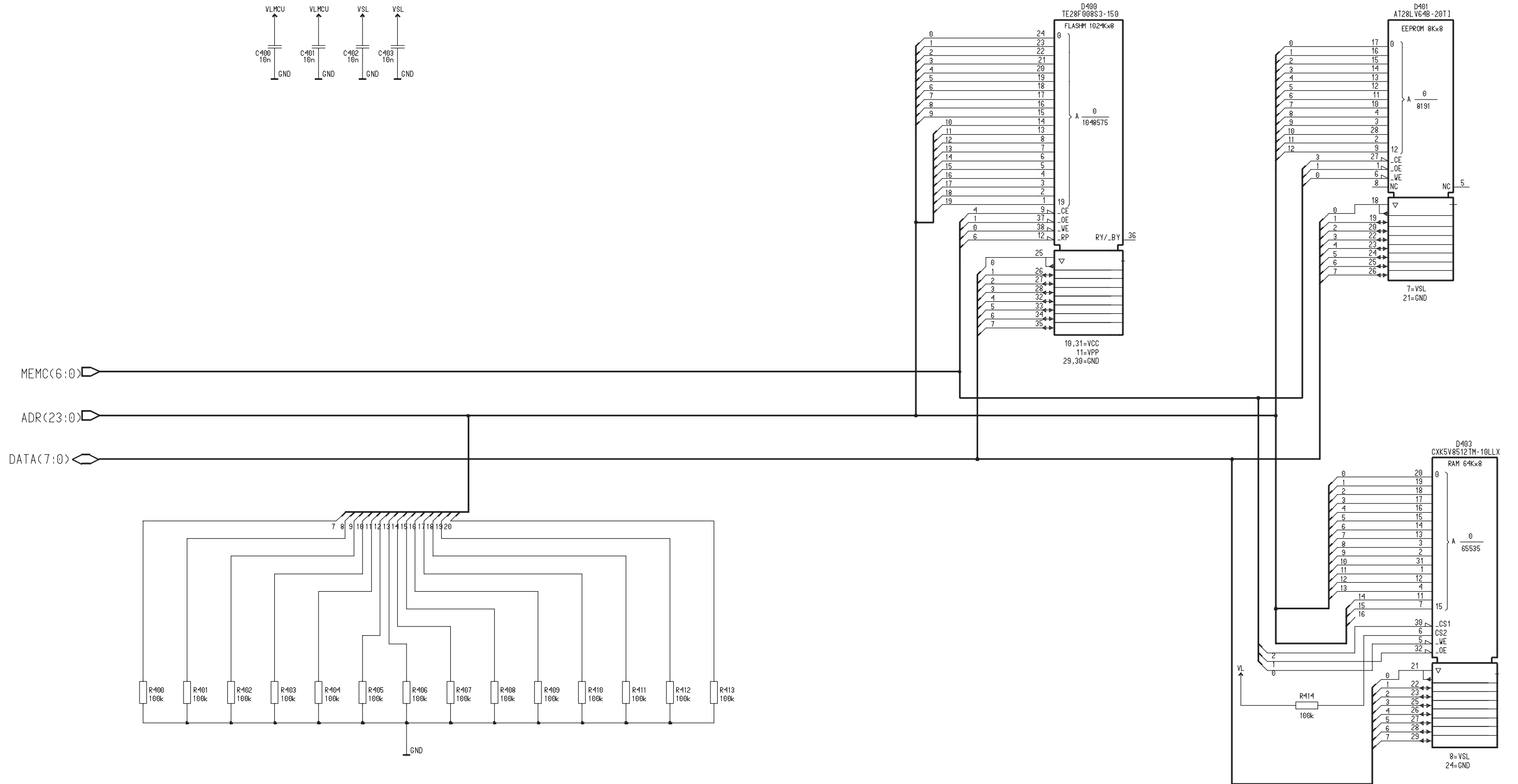



### Circuit Diagram of Keyboard and Display Interface (GJ8A) (Version: 3.5 ; Edit 47) for layout version 02

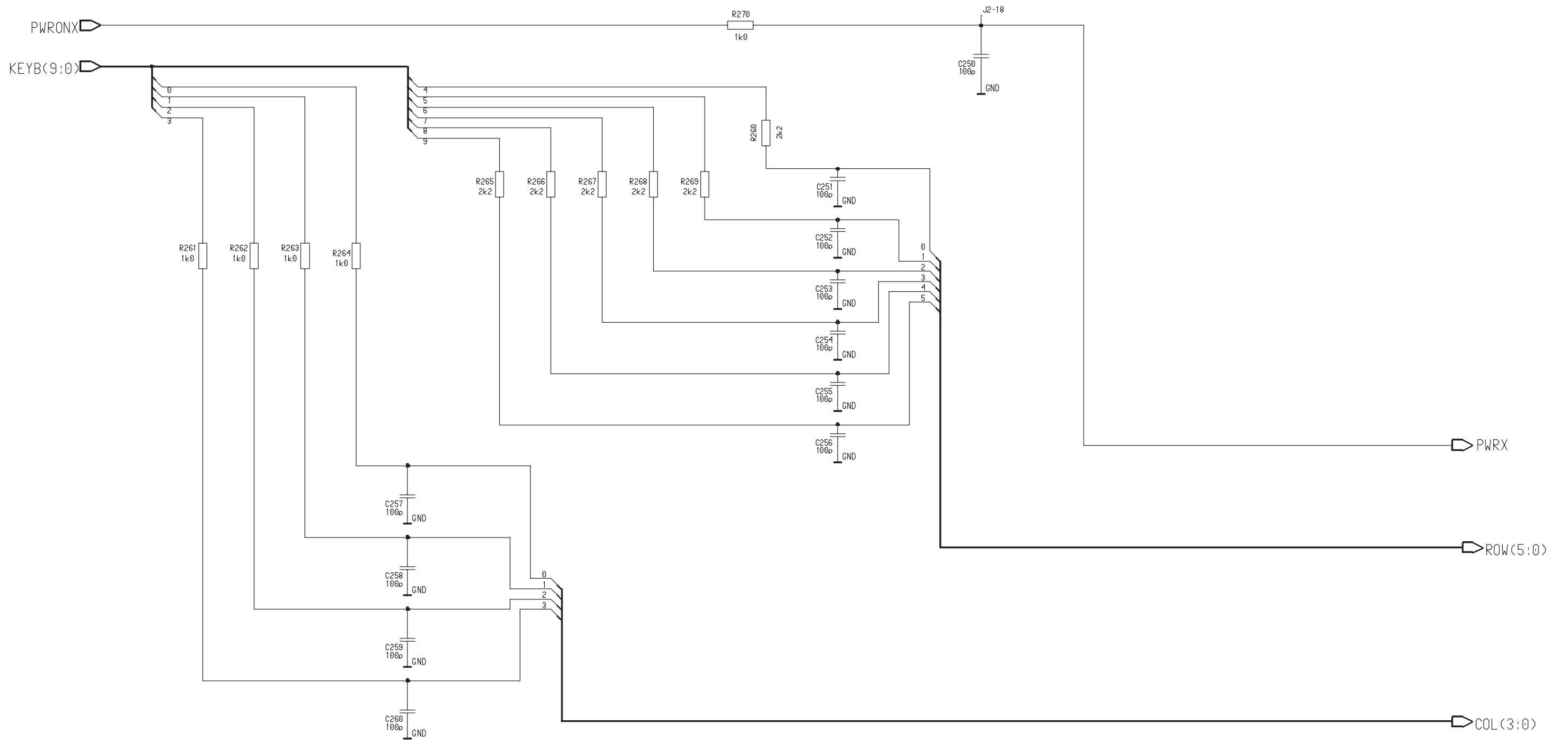

### Circuit Diagram of Audio (GJ8A) (Version: 3.5 ; Edit 89) for layout version 02

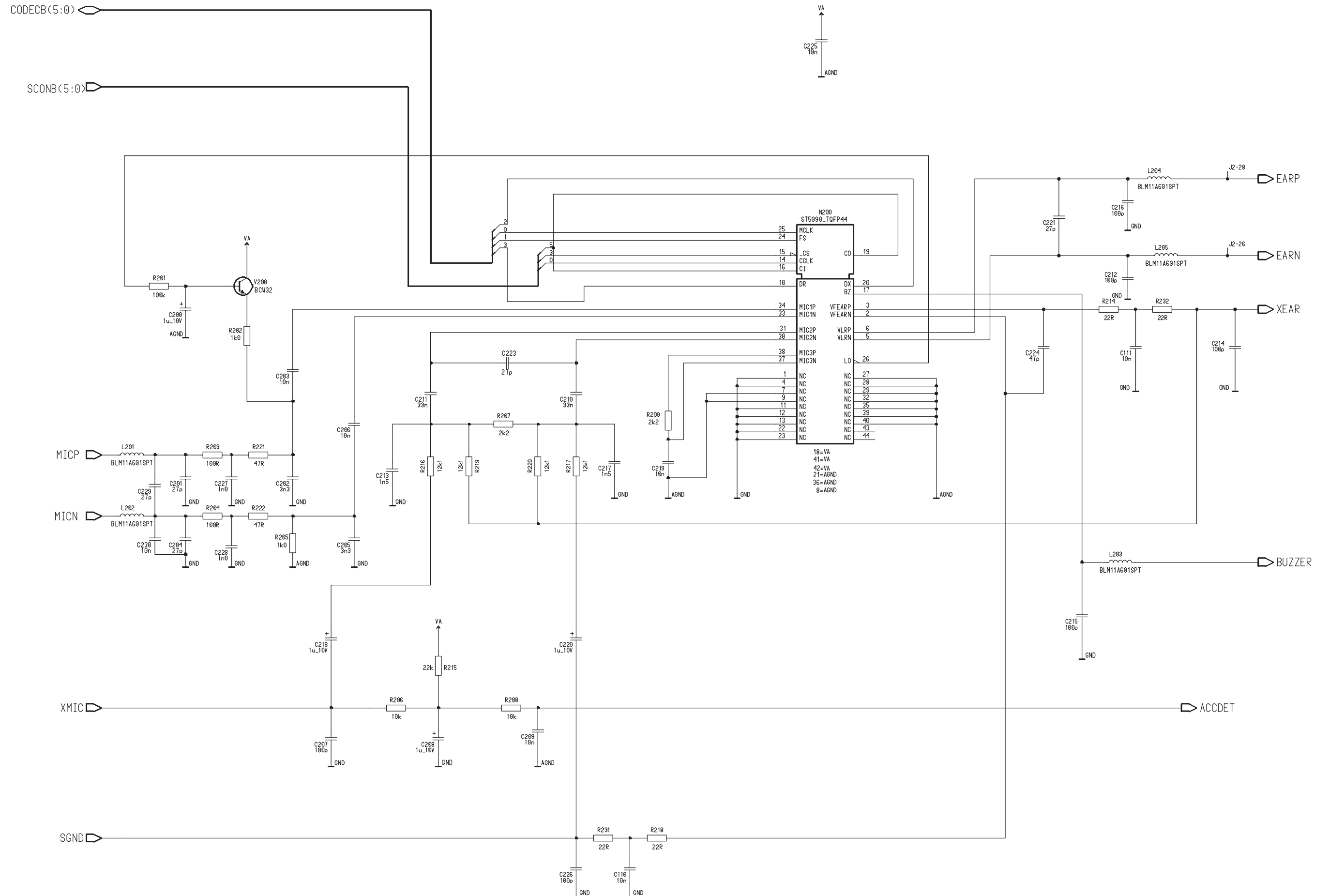

### Circuit Diagram of DSP Memory Block (GJ8A) (Version: 3.5 ; Edit 46) for layout version 02

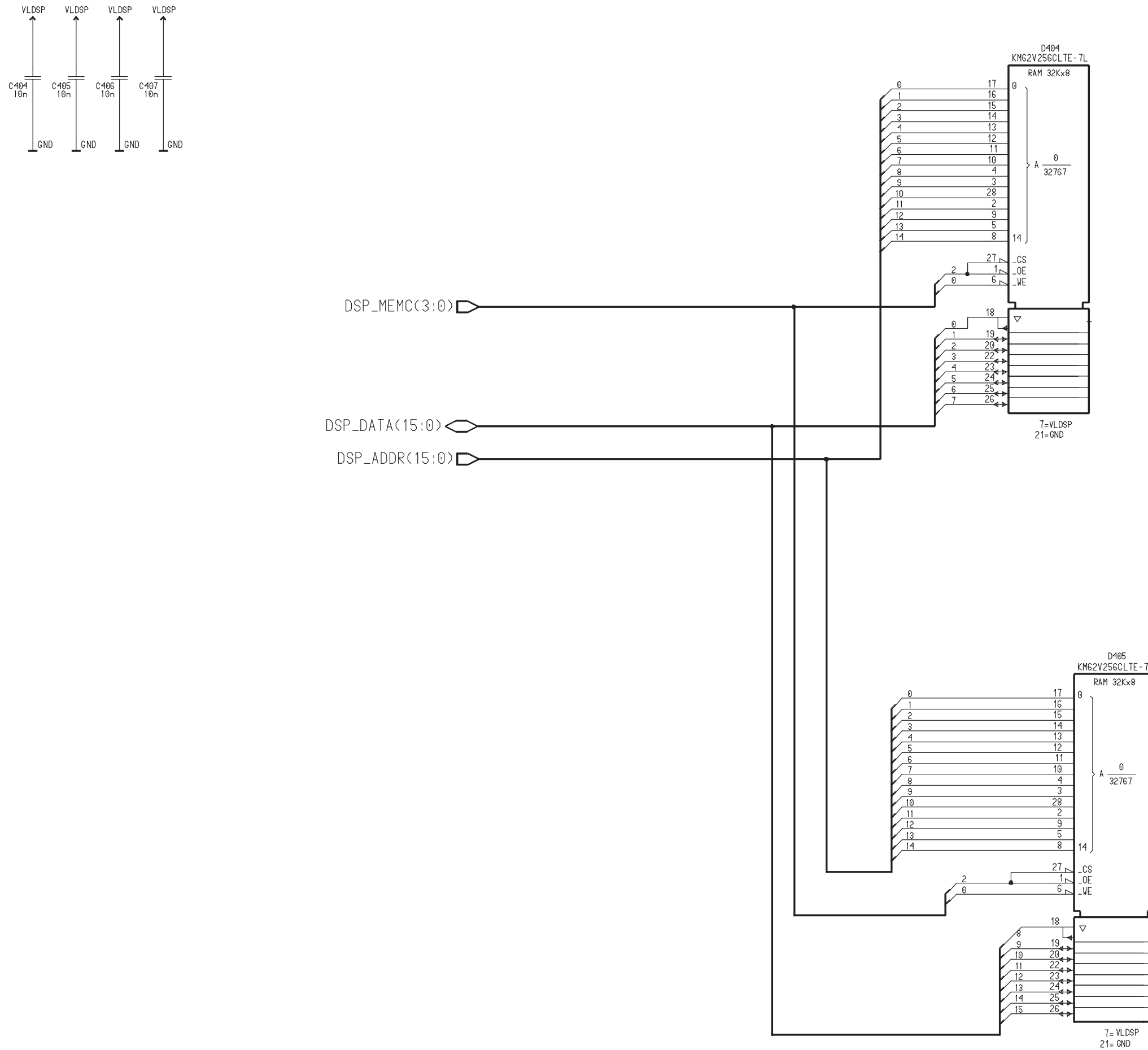

### Circuit Diagram of RFI (GJ8A) (Version: 3.5 ; Edit 94) for layout version 02

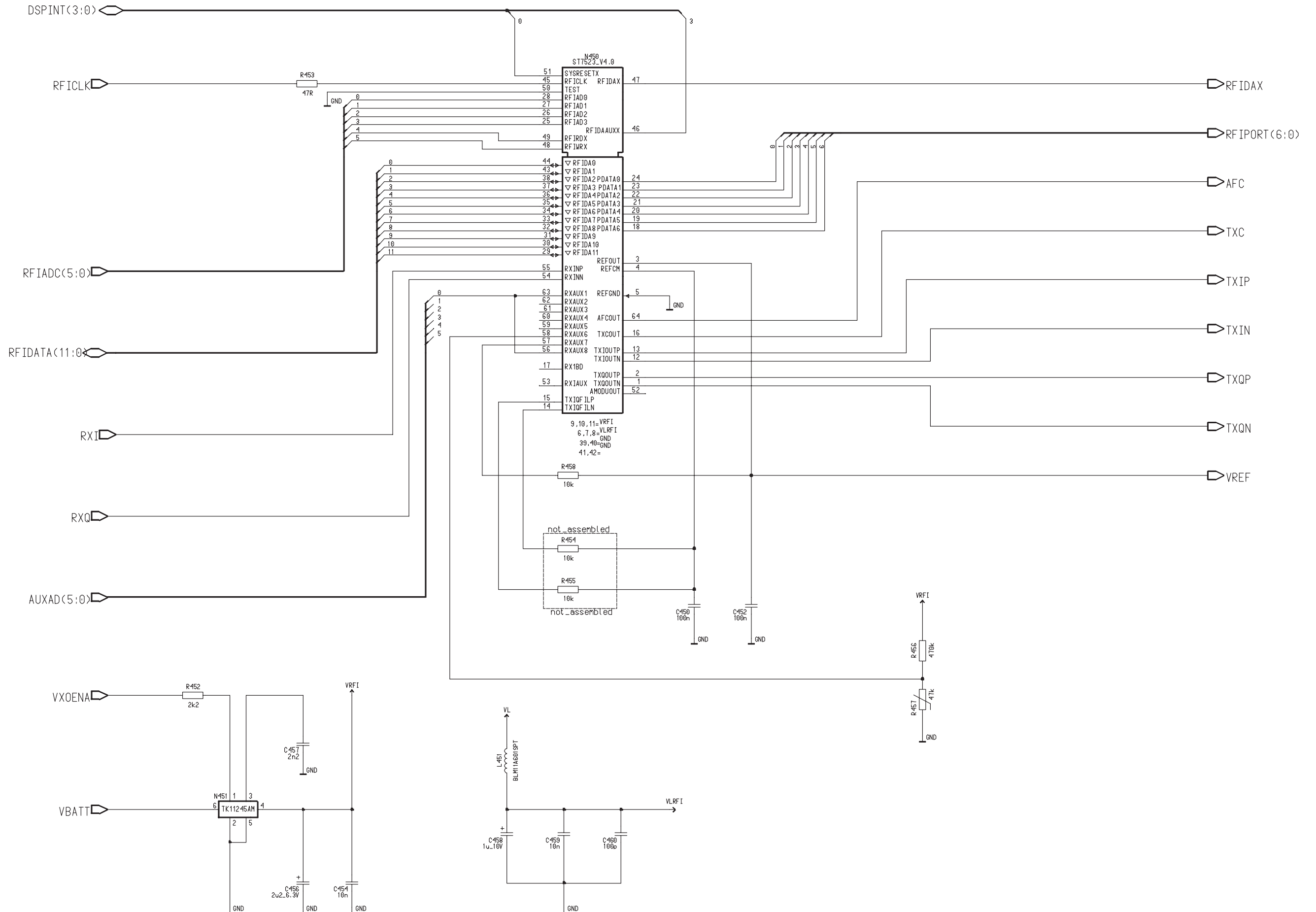



# Circuit Diagram of Transmitter (GJ8A) (Version: J22.7A ; Edit 360) for layout version 02

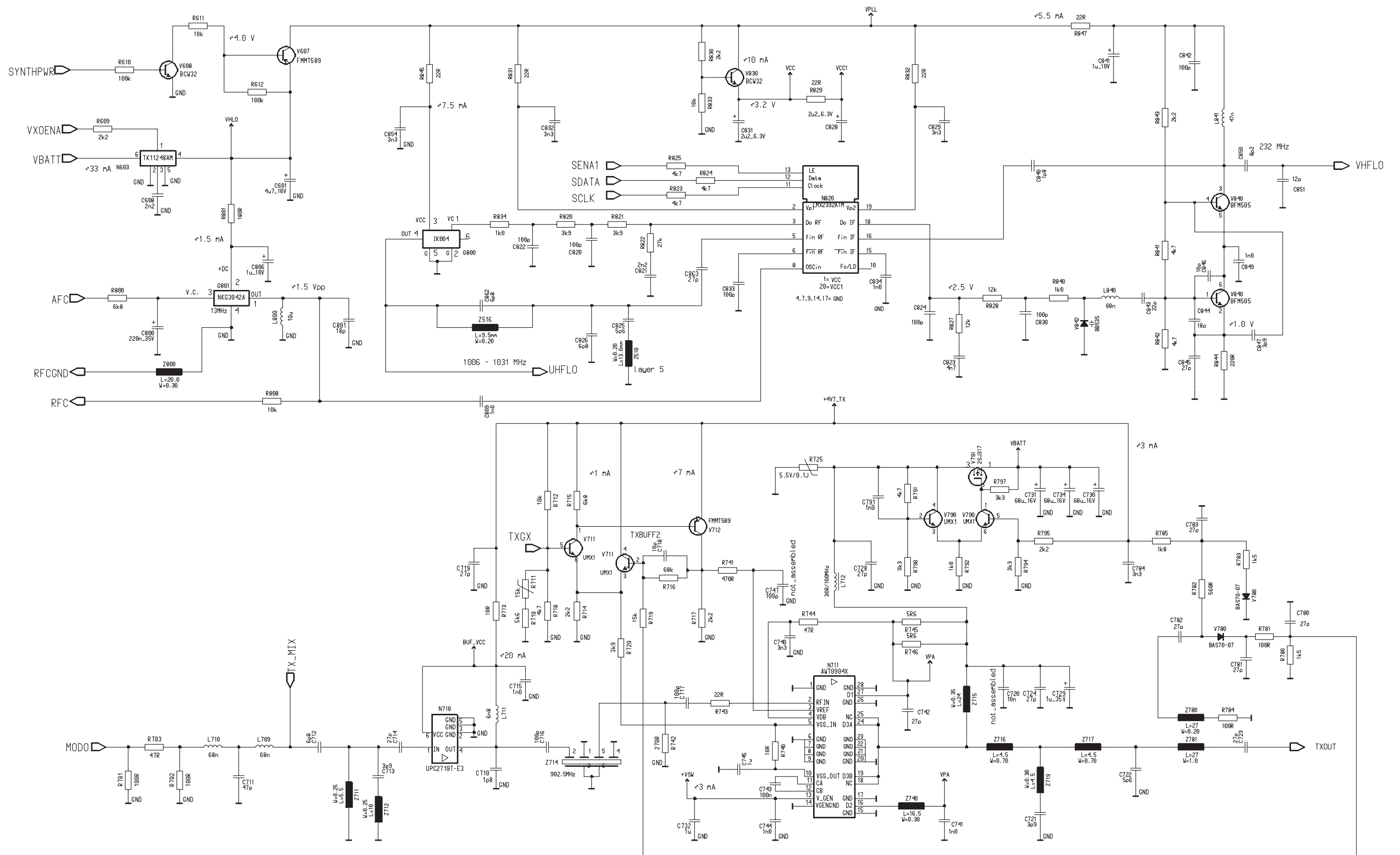

### Circuit Diagram of System Connector (GJ8A) (Version: 3.5 ; Edit 96) for layout version 02

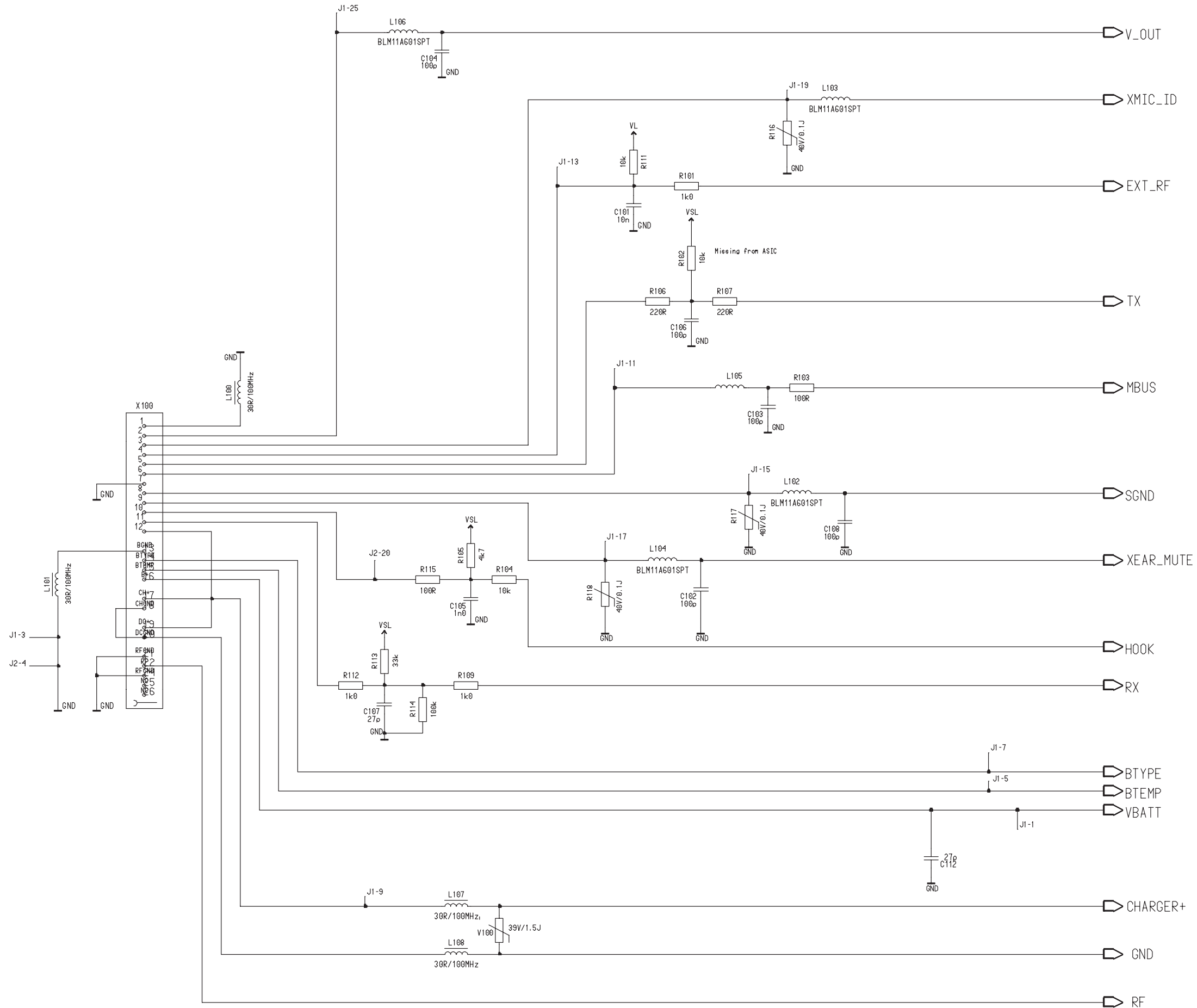

# Layout Diagrams of GJ8A (Version: 02)

