

Circuit Diagram of GU8 (Version: 8.0 Edit: 89)

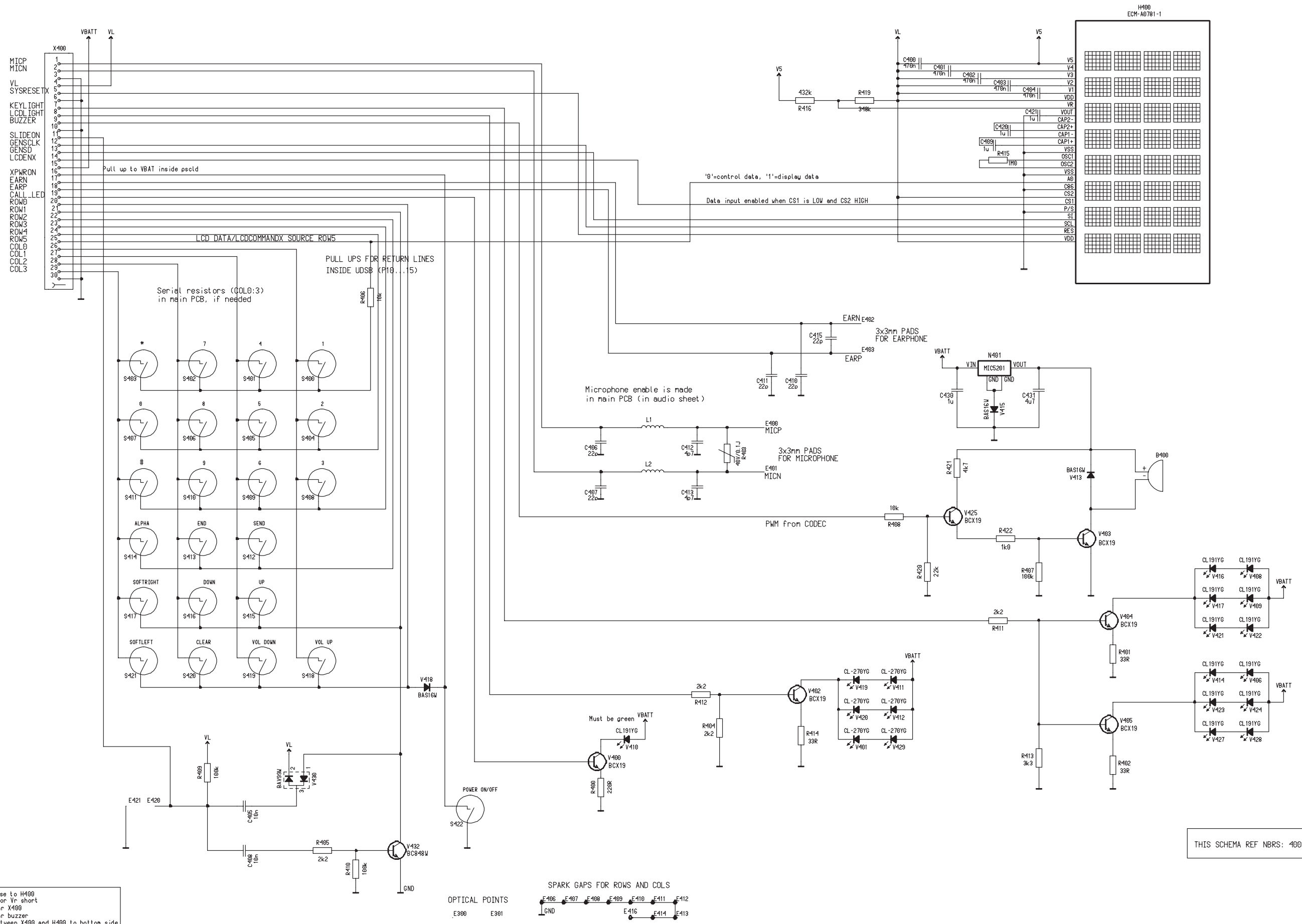

-R415 close to H400
 -wiring for Vr short
 -R408 near X400
 -V403 near buzzer
 -Lines between X400 and H400 to bottom side

SPARK GAPS FOR ROWS AND COLS
 OPTICAL POINTS
 E300 E301
 E406 E407 E408 E409 E410 E411 E412
 E416 E414 E413

Layout Diagram of GU8 (Version 09)

