

Trouble Shooting Guide, Mechanical

Applicable for G502

Contents

1	General	2
1.1	Service functions in the software	2
1.2	Misuse and other no warranty issues	3
2	Appearance Problems.....	7
3	Network/Signal Problems	8
4	On/Off Problems	11
5	Audio Problems	14
6	Key Problems.....	18
7	Display Problems	20
8	Illumination Problems	21
9	Alert Problems	23
10	SIM Problems.....	24
11	FM Radio Problems	25
12	M2 Memory Problems	26
13	Charging/Capacity Problems	27
14	Camera Problems	29
15	Data Communication Problems	34
16	Software Problems	35
17	Revision History	36

1 General

This document outlines the mechanical repairs that should be made in an attempt to fix the common failures that are seen in the field. To gain a complete understanding of how to test and repair a specific failure, this document should be used in conjunction with the Test Instructions, Mechanical and the Working Instructions, Mechanical.

1.1 Service functions in the software

The service menu will be accessed with the following key combination. Use the joystick.

⇒*←←*←*

They are as follows:

Service info

Service tests

Text labels

The phones software has a built in service functionality that allows you to test some of the phones functions. (*See point 2 above*) It looks like this:

Main display

LED/illumination

Keyboard

Speaker

Earphone

Microphone

Vibrator

Camera

Memory Stick

Real time clock

Total call time

NOTE: Different names may occur depending on language setting and customization.

1.2 Misuse and other no warranty issues





Misuse is not covered by warranty. This chapter will explain what's not covered by warranty. Phones that have been exposed to misuse will not be covered by warranty.

This means: if it is possible to repair the phone, the customer will have to pay for the repair. SEMC will not allow any of these phones to be claimed into WCMS. Some local perspectives may interfere with this. Please reference to local directives.

1.2.1 Action

Make a general visual inspection for misuse.

Below are some **examples** of what is not covered by warranty.

				
<p>Front window broken due to misuse.</p>	<p>LCD cracked due to drop.</p>	<p>Clear scratches</p>	<p>Mark after drop</p>	<p>Corrosion components on the PCB.</p>

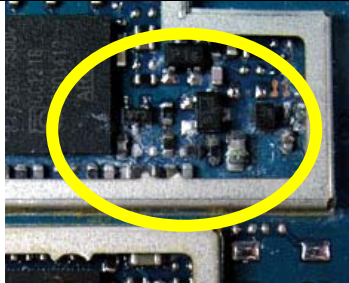
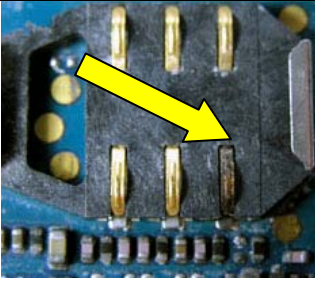
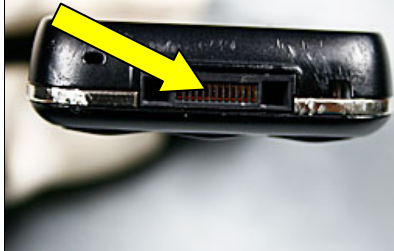
			
<p>Corrosion components on the PCB.</p>	<p>Corrosion components on the PCB.</p>	<p>SIM reader damaged by liquid.</p>	<p>System connector damaged by liquid</p>

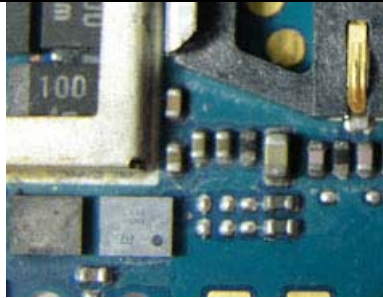
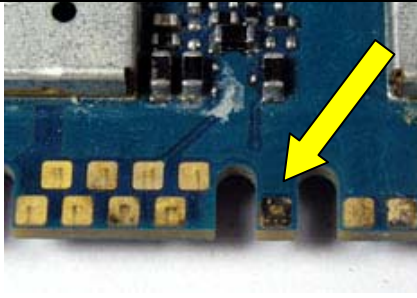
	
<p>Components around system connector damaged by liquid</p>	<p>System connector pad(s) damaged by liquid</p>

1.2.2 Liquid damage sticker

Trouble Shooting Guide Repair Instruction, Mechanical

In the phone there is placed a sticker that can give you a hint to see if the phone is damage by liquid or not. This sticker is located near the SIM reader (Fig. 1.2.1 & 1.2.2) and it is possible to see it without disassemble the phone.

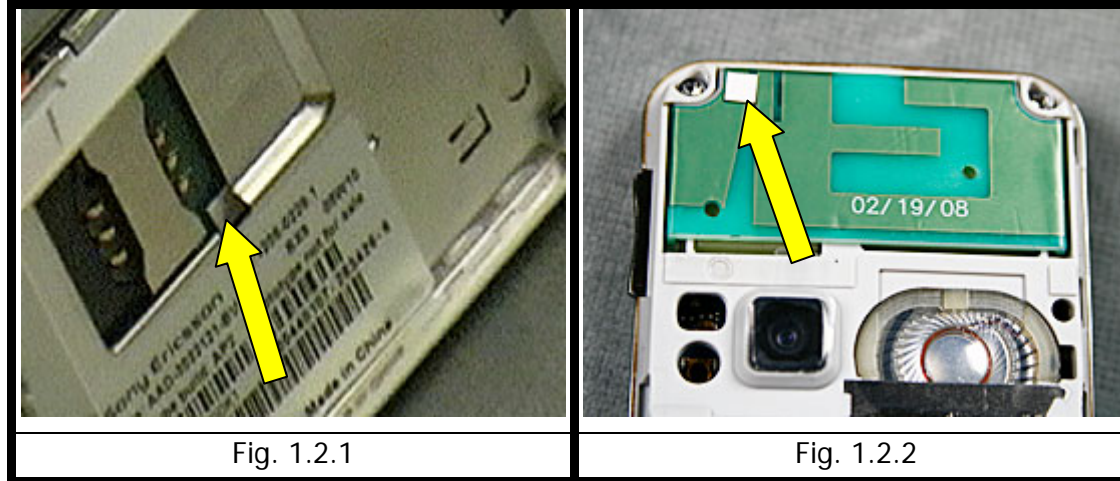
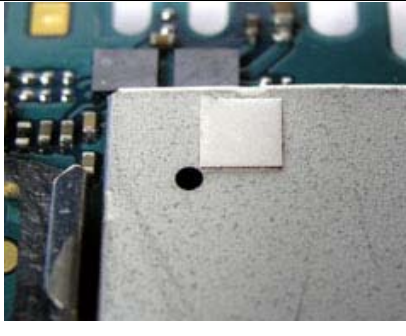
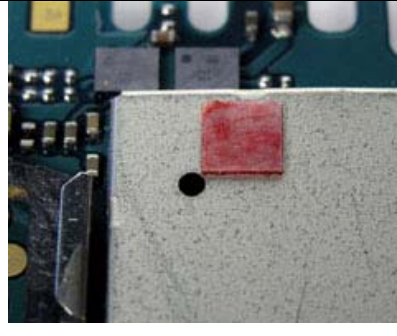

Fig. 1.2.1

Fig. 1.2.2

On the pictures below you will see the different between a sticker that has been in contact with liquid (Fig. 1.2.4) and with one that hasn't (Fig. 1.2.3).

This sticker is ok	This sticker <u>is not</u> ok	
		<p>The white sticker that has been in contact with liquid turns into a red or pink sticker. In this case you should check the phone for liquid damage (See point 1.1.1).</p> <p>Note: There must be clear marks after liquid on the PCB before rejecting the phone for repair.</p>
<p>Fig. 1.2.3</p>	<p>Fig. 1.2.4</p>	

1.2.3 Action

Make a general visual inspection for misuse, corrosion or oxidation from liquid damage. No further action should be taken for a liquid damaged phone. Handle the unit according to local directives.

2 Appearance Problems

Problem Area	Items to Check	Repair Action	Reference Image
Appearance	Visually inspect the cosmetic quality of all user viewable surfaces	<ul style="list-style-type: none"> If dirty – Clean parts as necessary. If unacceptably scratched or damaged – Replace damage parts as necessary. <p>NOTE: Misuse is not covered by warranty. Refer to chapter 1.2</p>	
	Visually inspect all keys	<ul style="list-style-type: none"> If dirty – Clean parts as necessary. If unacceptably scratched or damaged – Replace damaged parts as necessary. <p>NOTE: Misuse is not covered by warranty. Refer to chapter 1.2</p>	
	Visually inspect for improper gap between seams	<ul style="list-style-type: none"> Reassemble or replace damaged parts as necessary. 	

3 Network/Signal Problems

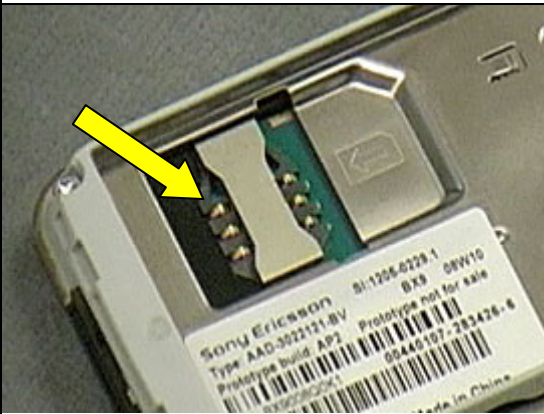
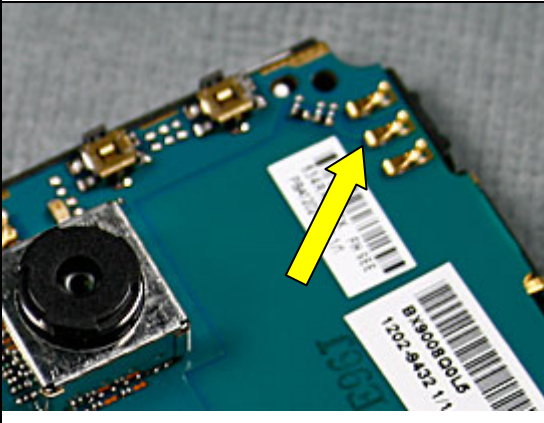
Problem Area	Items to Check	Repair Action	Reference Image
No Signal or Poor Signal	Before proceeding →	Perform a flash upgrade.	
	Visually inspect SIM holder	<ul style="list-style-type: none"> • If dirty or oxidized – Clean it. • If damaged – Send to an electrical repair location. 	
	Visually inspect antenna contact pins.	<ul style="list-style-type: none"> • If dirty or oxidized – Clean the pins and replace the antenna assembly. 	

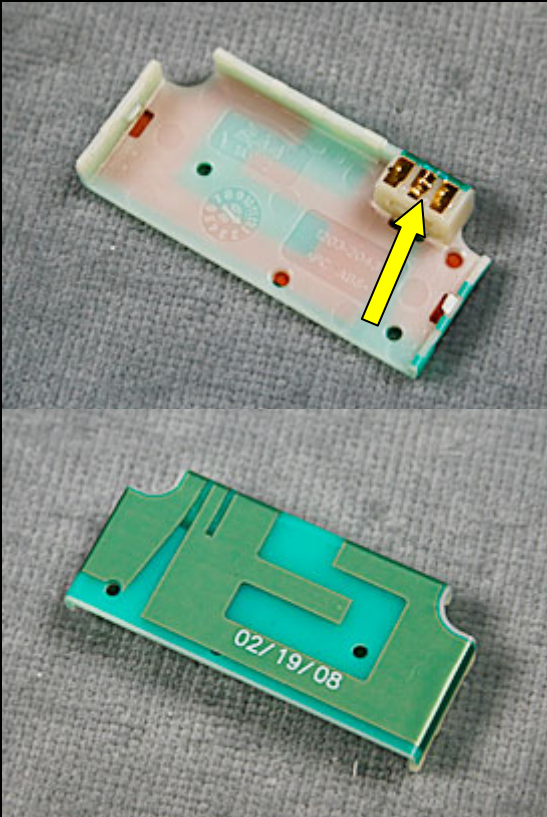
Problem Area	Items to Check	Repair Action	Reference Image
	<p>Visually inspect antenna</p>	<ul style="list-style-type: none"> If dirty, oxidized or damaged – Replace it. 	
	<p>If the issue has not been resolved →</p>	<ul style="list-style-type: none"> Handle the unit according to local directives. 	

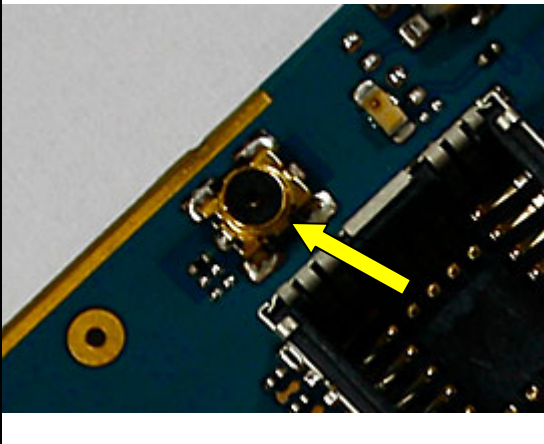

Trouble Shooting Guide Repair Instruction, Mechanical

Problem Area	Items to Check	Repair Action	Reference Image
<p>No signal when using external antenna (ex. Hands free in car).</p>	<p>Connect the phone to hands free car kit connected with external antenna.</p> <p>Visually inspect the antenna bar on the phone.</p>	<ul style="list-style-type: none"> If no or only very less signal – Push the middle pin of the ext. antenna connector a few times. 	
	<p>If the issue has not been resolved →</p>	<ul style="list-style-type: none"> Handle the unit according to local directives. 	

4 On/Off Problems

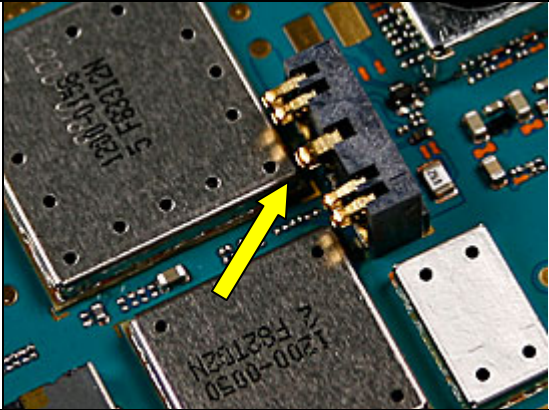

Problem Area	Items to Check	Repair Action	Reference Image
Power On problems	Check whether the phone vibrates 10 to 15 seconds after pressing the power key and whether the keypad illuminates	<ul style="list-style-type: none"> If activation of the vibrator or keypad are detected, refer to the "Display Problems" chapter 7 	
	Before proceeding →	<ul style="list-style-type: none"> Perform a flash upgrade. 	
	Visually inspect contact pads on battery	<ul style="list-style-type: none"> If dirty or oxidized – Clean pads. If damaged – Replace the battery. 	

Trouble Shooting Guide Repair Instruction, Mechanical

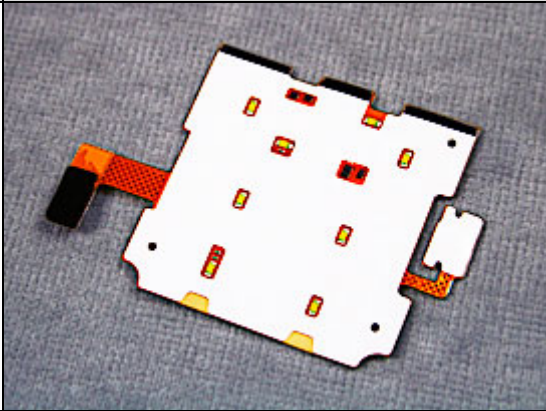

Problem Area	Items to Check	Repair Action	Reference Image
	Visually inspect battery connector	<ul style="list-style-type: none"> If dirty or oxidized – Clean it. Note: Take care not to bend the connector pin's. If damaged – Send to an electrical repair location. 	
	Visually inspect the power key	<ul style="list-style-type: none"> If damaged – Replace Keypad. 	

Problem Area	Items to Check	Repair Action	Reference Image
	If the issue has not been resolved →	<ul style="list-style-type: none"> • Replace keyboard FPC 	
	If the issue has not been resolved →	<ul style="list-style-type: none"> • Handle the unit according to local directives. 	

5 Audio Problems

Problem Area	Items to Check	Repair Action	Reference Image
Microphone:	Before proceeding →	<ul style="list-style-type: none"> Perform a flash upgrade and a setting reset. 	
	Visually inspect the microphone's external port	<ul style="list-style-type: none"> If clogged - Clean or replace rear cover. 	
	If the issue has not been resolved →	<ul style="list-style-type: none"> Handle the unit according to local directives. 	
Speaker: No sound or poor quality sound	Before proceeding →	<ul style="list-style-type: none"> Perform a flash upgrade and a setting reset. 	
	Visually inspect speaker's external port	<ul style="list-style-type: none"> If clogged – Clean or replace front. 	

Trouble Shooting Guide Repair Instruction, Mechanical

Problem Area	Items to Check	Repair Action	Reference Image
	Visually inspect speaker's dust cloth	<ul style="list-style-type: none"> If dirty or damaged – Replace front. 	
	If the issue has not been resolved →	<ul style="list-style-type: none"> Replace receiver. 	
	If the issue has not been resolved →	<ul style="list-style-type: none"> Handle the unit according to local directives. 	
Loudspeaker: No sound or poor quality sound	Before proceeding →	<ul style="list-style-type: none"> Perform a flash upgrade and a setting reset. 	
	Visually inspect speaker's external port	<ul style="list-style-type: none"> If clogged – Clean it. 	

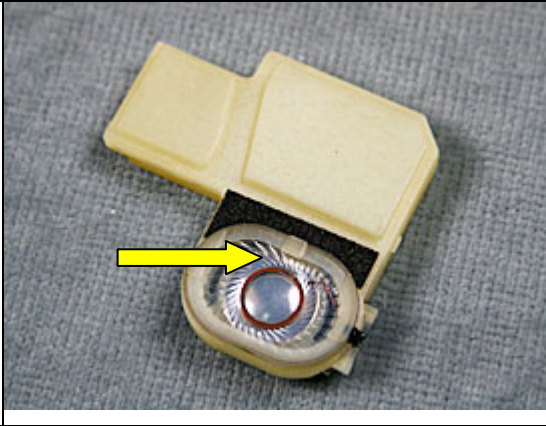
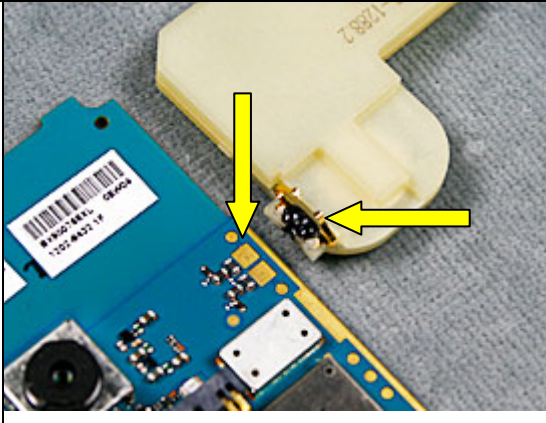

Problem Area	Items to Check	Repair Action	Reference Image
	Visually inspect the loudspeaker's BOX dust cloth.	<ul style="list-style-type: none"> If dirty or damaged – Clean the Speaker Box 	
	Visually inspect the loudspeaker pins.	<ul style="list-style-type: none"> If dirty or oxidized – Clean pins. If damaged send to electrical repair. 	

Problem Area	Items to Check	Repair Action	Reference Image
	If the issue has not been resolved →	<ul style="list-style-type: none"> • Replace Speaker Box Assembly 	
	If the issue has not been resolved →	<ul style="list-style-type: none"> • Handle the unit according to local directives. 	

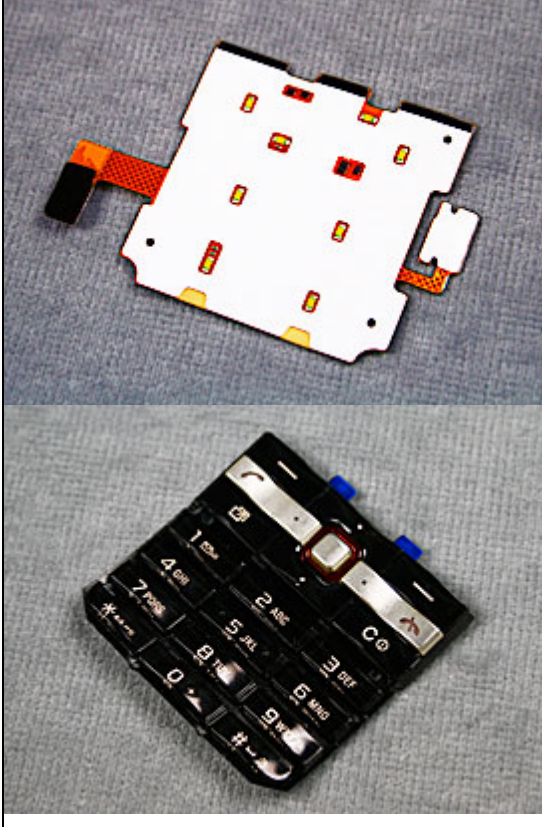

6 Key Problems

Problem Area	Items to Check	Repair Action	Reference Image
<p>Keyboard: A key on the keyboard is not functioning or is intermittent.</p>	<p>Visually inspect for debris between keypad key flex module, and for damage to the keypad and the key flex module.</p> <p>NOTE: Camera switch is located on the key foil Dome Assy.</p>	<ul style="list-style-type: none"> • If dirty – Clean both parts. • If damaged - Replace keypad and/or key Foil Dome Assy as necessary. 	

Trouble Shooting Guide Repair Instruction, Mechanical

Problem Area	Items to Check	Repair Action	Reference Image
	<p>Visually inspect whether the key flex module is properly connected to its connector on the PCB.</p>	<ul style="list-style-type: none"> • If improperly connected – Re-establish proper connection. 	
	<p>If the issue has not been resolved →</p>	<ul style="list-style-type: none"> • Replace key flex module, if it has not already been replaced. 	
	<p>If the issue has not been resolved →</p>	<ul style="list-style-type: none"> • Handle the unit according to local directives. 	
<p>Side keys</p>	<p>Visually inspect for damage to the side keys “Volume Key & Camera Key”</p>	<ul style="list-style-type: none"> • If damaged - Replace keys as necessary. 	
	<p>If the issue has not been resolved →</p>	<ul style="list-style-type: none"> • Handle the unit according to local directives. 	

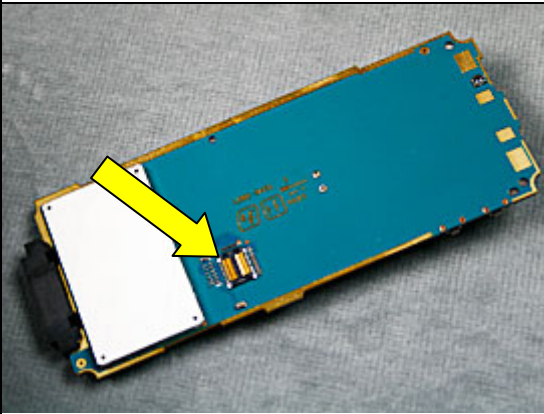

7 Display Problems

Problem Area	Items to Check	Repair Action	Reference Image
LCD problem	Check whether the phone vibrates 10 to 15 seconds after pressing the power key and whether the keypad illuminates	<ul style="list-style-type: none"> If activation of the vibrator are not detected, refer to the On/Off Problems" chapter 2 	
	Before proceeding →	<ul style="list-style-type: none"> Perform a flash upgrade and a setting reset. 	
	Visually inspect whether the LCD flex film is properly connected to its connector on the PCB	<ul style="list-style-type: none"> If improperly connected – Re-establish proper connection. 	
	If the issue has not been resolved →	<ul style="list-style-type: none"> Replace the LCD. <p>NOTE: Misuse is not covered by warranty. Refer to chapter 1.2</p>	

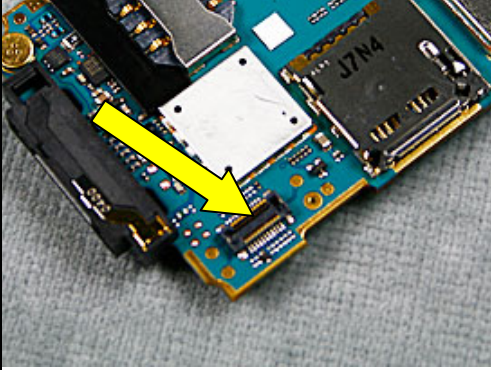
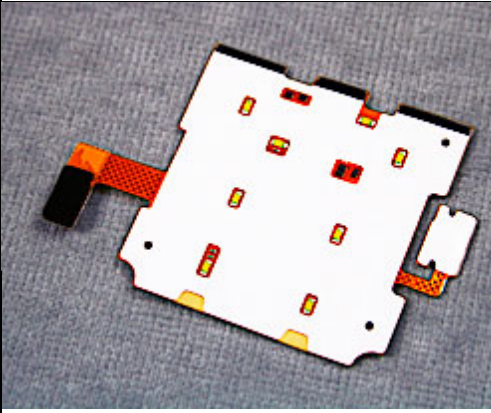
8 Illumination Problems

Problem Area	Items to Check	Repair Action	Reference Image
Keys: The entire keypad or a portion of the keypad does not illuminate.	Before proceeding →	<ul style="list-style-type: none"> Perform a flash upgrade and a setting reset. 	
	Visually inspect whether the key flex module is properly connected to its connector on the PCB.	<ul style="list-style-type: none"> If improperly connected – Re-establish proper connection. 	
	Visually inspect the Key Foil Dome Assy	<ul style="list-style-type: none"> If dirty or oxidized – Replace it. If damaged – Replace it 	
	If the issue has not been resolved →	<ul style="list-style-type: none"> Replace the key flex module. 	
If the issue has not been resolved →	<ul style="list-style-type: none"> Handle the unit according to local directives. 		

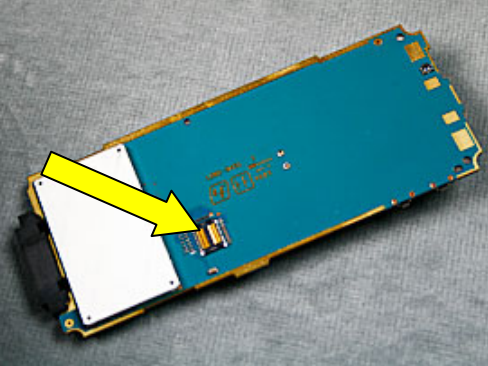
Trouble Shooting Guide Repair Instruction, Mechanical

Problem Area	Items to Check	Repair Action	Reference Image
LCD	Before proceeding →	<ul style="list-style-type: none"> Perform a flash upgrade and a setting reset. 	
	Visually inspect whether the LCD flex film is properly connected to its connector on the PCB.	<ul style="list-style-type: none"> If improperly connected – Re-establish proper connection. 	
	If issue has not been resolved. →	<ul style="list-style-type: none"> Replace the LCD. 	
	If the issue has not been resolved. →	<ul style="list-style-type: none"> Handle the unit according to local directives. 	

9 Alert Problems

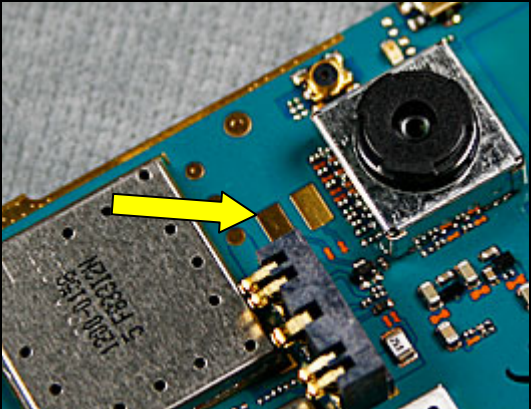
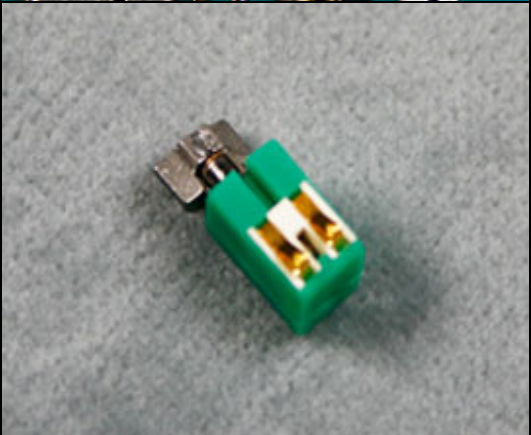
Problem Area	Items to Check	Repair Action	Reference Image
Vibrator:	Before proceeding →	<ul style="list-style-type: none"> Perform a flash upgrade and a setting reset. 	
	Visually inspect the vibrator pads on the PCB.	<ul style="list-style-type: none"> If dirty or oxidized – Clean them. 	
	Visually inspect the vibrator.	<ul style="list-style-type: none"> If dirty or oxidized – Replace it. If damaged – Replace it. 	
Loudspeaker	Refer to “ loudspeaker ” section under “Audio Problems”		



10 SIM Problems

Problem Area	Items to Check	Repair Action	Reference Image
SIM undetected (Insert SIM)	Inspect SIM holder.	<ul style="list-style-type: none"> If dirty or oxidized – Clean. If damaged – Send to an electrical repair location. 	
Unit indicates an incorrect SIM is inserted (Insert correct SIM)	Check whether the phone is locked to a particular carrier and whether the correct carrier's SIM is being used.	<ul style="list-style-type: none"> Use Correct Carrier SIM or test SIM. 	
	If the issue has not been resolved. →	<ul style="list-style-type: none"> Handle the unit according to local directives. 	

11 FM Radio Problems

Problem Area	Items to Check	Repair Action	Reference Image
FM Radio	Inspect System Connector	<ul style="list-style-type: none"> • If dirty or oxidized – Clean. • If damaged – Replace 	
FM Radio	Inspect Stereo Headset	<ul style="list-style-type: none"> • Use test Stereo Headset to verify fault • <i>If faulty inform customer to purchase new Stereo Headset if part is not defined as spare replacement part.</i> 	
	If the issue has not been resolved →	<ul style="list-style-type: none"> • Handle the unit according to local directives. 	

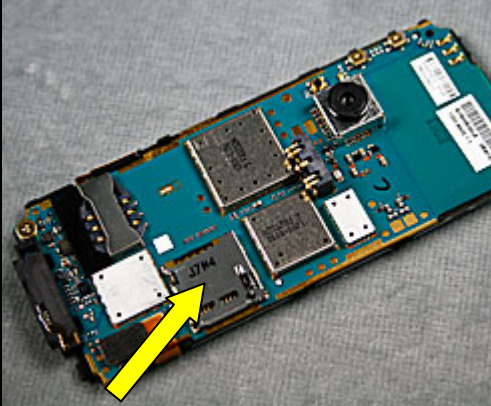
12 M2 Memory Problems

Problem Area	Items to Check	Repair Action	Reference Image
M2 undetected	Inspect M2 holder	<ul style="list-style-type: none"> • If dirty or oxidized – Clean. • If damaged – Send to an electrical repair location. 	
M2 undetected	Inspect M2 Card	<ul style="list-style-type: none"> • Use test M2 card to verify fault • If dirty or oxidized – Clean. • Replace M2 Memory Card 	
	If the issue has not been resolved →	<ul style="list-style-type: none"> • Handle the unit according to local directives. 	

13 Charging/Capacity Problems

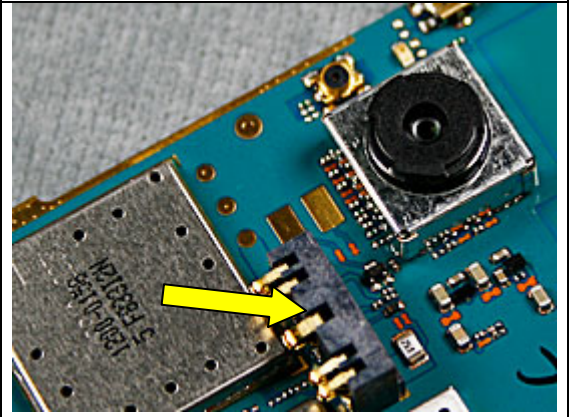
Problem Area	Items to Check	Repair Action	Reference Image
Battery will not charge	Visually inspect the contact pads of the battery	<ul style="list-style-type: none"> • If dirty or oxidized – Clean. • If damaged – Replace battery. 	
	Visually inspect the battery connector	<ul style="list-style-type: none"> • If dirty or oxidized – Clean. • If damaged – Send to an electrical repair location. 	
Battery loses charge quickly/standby time seems short	Before proceeding → NOTE: Some features noticeably reduce the amount of standby time if they are turned on. Some examples are the back light (when on all the	<ul style="list-style-type: none"> • Perform a flash upgrade and a setting reset. 	

	<p>time and), Bluetooth and infrared.</p>		
	<p>If the issue has not been resolved →</p>	<ul style="list-style-type: none"> • Replace battery. 	
	<p>If the issue has not been resolved →</p>	<ul style="list-style-type: none"> • Handle the unit according to local directives. 	

14 Camera Problems

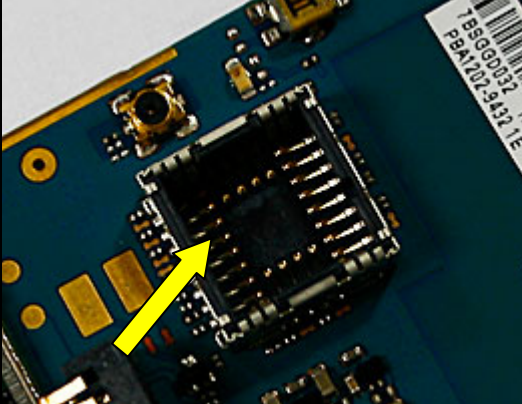
Problem Area	Items to Check	Repair Action	Reference Image
<p>Camera rear (2.0 Mega pixel)</p> <p>Lines, marks, blurred or discolored picture/ Will not enter camera menu</p>	<p>Visually inspect the camera lens</p>	<ul style="list-style-type: none"> If scratched or damaged – Rear cover. 	
	<p>Visually inspect whether the camera is properly connected to its socket on the PCB.</p>	<ul style="list-style-type: none"> If improperly connected – Re-establish proper connection. 	

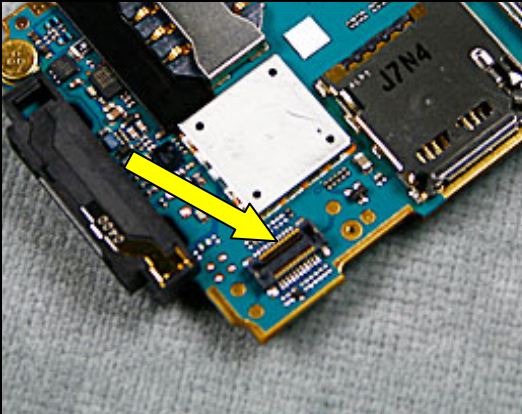
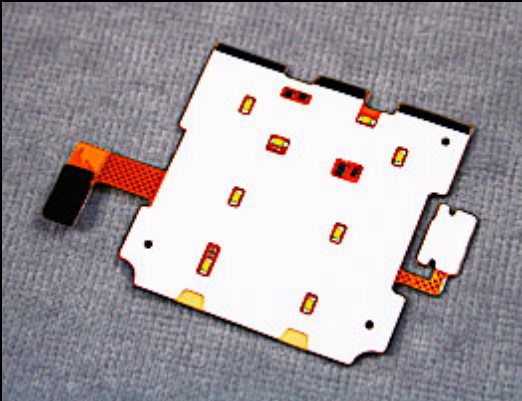

Problem Area	Items to Check	Repair Action	Reference Image
	If the issue has not been resolved →	<ul style="list-style-type: none"> Replace the 2.0 Mega Pixel camera. 	
	If the issue has not been resolved →	<ul style="list-style-type: none"> Handle the unit according to local directives. 	

Problem Area	Items to Check	Repair Action	Reference Image
<p>Will not capture an image</p>	<p>Visually inspect for debris between and/or damage to the camera key and the key flex module.</p>	<ul style="list-style-type: none"> • If dirty – Clean both parts. • If damaged - Replace the camera key and/or the key flex module as necessary. 	

Problem Area	Items to Check	Repair Action	Reference Image
	Visually inspect whether the key flex module is properly connected to its connector on the PCB.	<ul style="list-style-type: none"> If improperly connected – Re-establish proper connection. 	
	If the issue has not been resolved →	<ul style="list-style-type: none"> Replace the key flex module if it has not already been replaced. 	

Problem Area	Items to Check	Repair Action	Reference Image
	If the issue has not been resolved →	<ul style="list-style-type: none"> Replace 2.0 Mega Pixel camera. 	
	If the issue has not been resolved →	<ul style="list-style-type: none"> Handle the unit according to local directives. 	

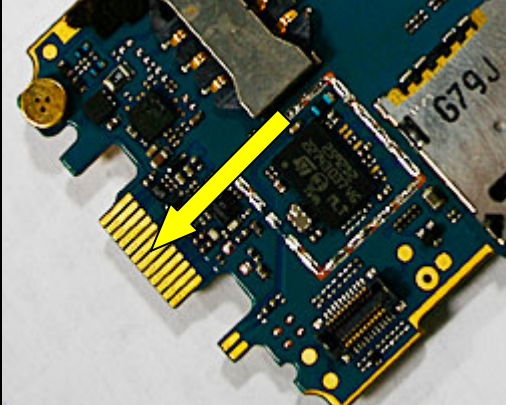
15 Data Communication Problems

Problem Area	Items to Check	Repair Action	Reference Image
Will not connect with a functional Bluetooth device	Visually inspect the system connector pads for dirt.	<ul style="list-style-type: none"> If dirty – Clean it. 	
	If the issue has not been resolved →	<ul style="list-style-type: none"> Replace the system connector. <p>NOTE: The system connector includes the bluetooth antenna.</p>	
	If the issue has not been resolved →	<ul style="list-style-type: none"> Handle the unit according to local directives. 	

16 Software Problems

- If there are problems with the response of the keypad commands, spelling errors in the menu or the phone hang, if they are not related to mechanical damage, make a master reset and flash the phone with the latest software from EMMA.
- Checking the software revision can be done in the Service info, see chapter *Service functions in the software*.
Choose: Service info / SW information.
The Software revision and date will be shown in the display.

Note: Do a SW upgrade before sending the unit to a higher level. Do **not** scrap a phone that hasn't been upgraded.

If the failure still occurs, handle the unit according to the local directives.

17 Revision History

Rev.	Date	Changes / Comments
1	2008-05-26	First release