

Trouble Shooting Guide, Mechanical

Applicable for K310

Contents

1	General	2
1.1	Service functions in the software	2
1.2	Misuse and other no warranty issues	3
2	Appearance Problems	6
3	Network/Signal Problems	8
4	On/Off Problems	11
5	Audio Problems	13
6	Key Problems.....	17
7	Display Problems	20
8	Illumination Problems	21
9	Alert Problems	23
10	SIM Problems	25
11	Charging/Capacity Problems	26
12	Camera Problems	28
13	Data Communication Problems	29
14	Software Problems	30
15	Revision History	31

1 General

This document outlines the mechanical repairs that should be made in an attempt to fix the common failures that are seen in the field. To gain a complete understanding of how to test and repair a specific failure, this document should be used in conjunction with the Test Instructions, Mechanical and the Working Instructions, Mechanical.

1.1 Service functions in the software

The service menu will be accessed with the following key combination. Use the joystick.

⇒*←←*←*

They are as follows:

Service info

Service tests

Text labels

The phones software has a built in service functionality that allows you to test some of the phones functions. (See *point 2 above*) It looks like this:

Main display

LED/illumination

Keyboard

Speaker

Earphone

Microphone

Vibrator

Camera

Real time clock

Total call time

NOTE: Different names may occur depending on language setting and customization.

1.2 Misuse and other no warranty issues





Misuse is not covered by warranty. This chapter will explain what's not covered by warranty. Phones that have been exposed to misuse will not be covered by warranty.

This means: if it is possible to repair the phone, the customer will have to pay for the repair. SEMC will not allow any of these phones to be claimed into WCMS. Some local perspectives may interfere with this. Please reference to local directives.

1.2.1 Action

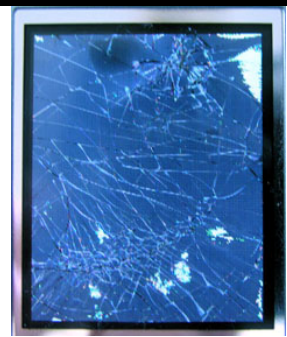
Make a general visual inspection for misuse.

Below are some **examples** of what is not covered by warranty.

				
<p>Front window broken due to misuse.</p>	<p>LCD cracked due to drop.</p>	<p>Clear scratches</p>	<p>Mark after drop</p>	<p>Corrosion components on the PCB.</p>

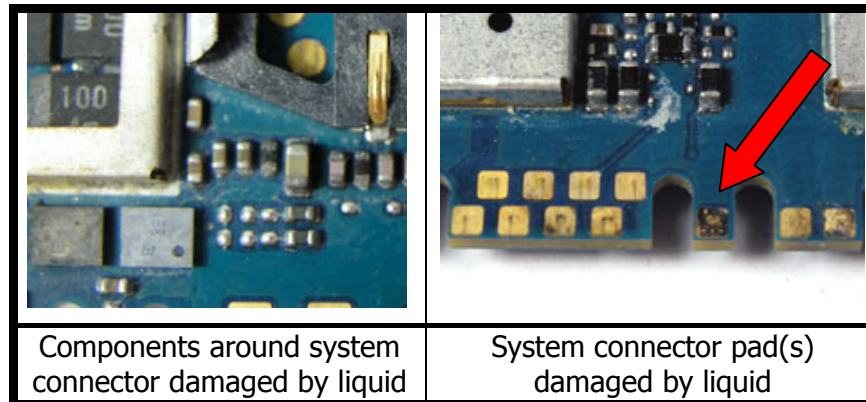
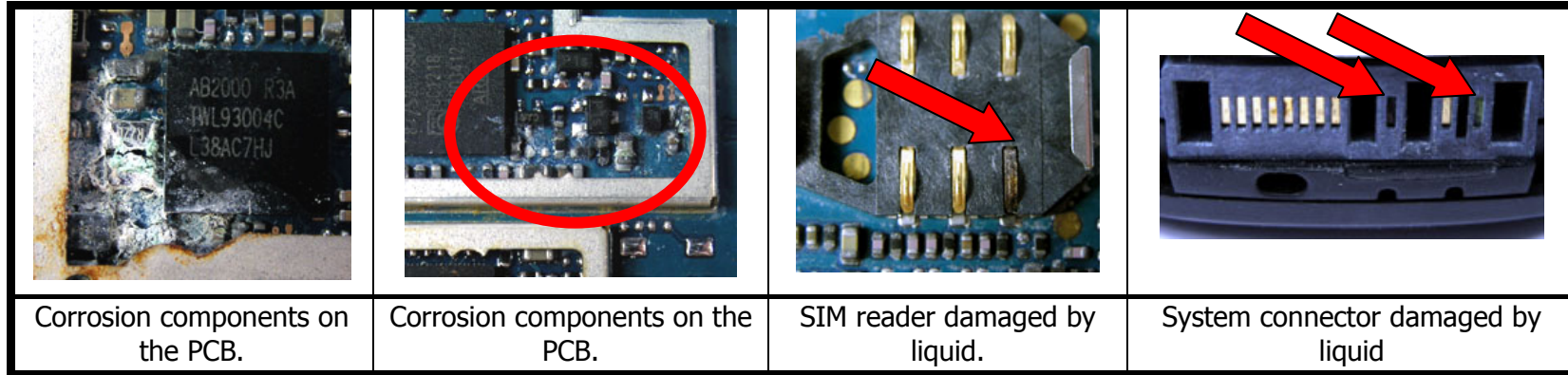

1.2.2 Liquid damage sticker

In the phone there is placed a sticker that can give you a hint to see if the phone is damage by liquid or not. This sticker is located near the SIM reader (Fig. 1.2.1) and it is possible to see it without disassemble the phone.

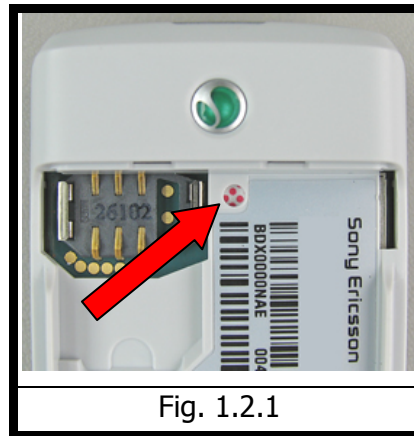
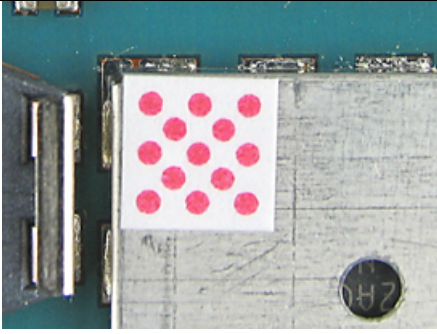
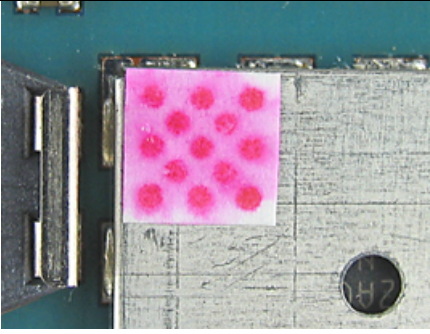

Fig. 1.2.1





On the pictures below you will see the different between a sticker that has been in contact with liquid (Fig. 1.2.3) and with one that hasn't (Fig. 1.2.2).

This sticker is ok	This sticker <u>is not</u> ok	
		<p>The white sticker that has been in contact with liquid turns into a red or pink sticker. In this case you should check the phone for liquid damage (See point 1.1.1).</p> <p>Note: There must be clear marks after liquid on the PCB before rejecting the phone for repair.</p>
<p>Fig. 1.2.2</p>	<p>Fig. 1.2.3</p>	

1.2.3 Action

Make a general visual inspection for misuse, corrosion or oxidation from liquid damage. No further action should be taken for a liquid damaged phone. Handle the unit according to local directives.

2 Appearance Problems

Problem Area	Items to Check	Repair Action	Reference Image
Appearance	Visually inspect the cosmetic quality of all user viewable surfaces	<ul style="list-style-type: none"> • If dirty – Clean parts as necessary. • If unacceptably scratched or damaged – Replace damage parts as necessary. <p>NOTE: Misuse is not covered by warranty. Refer to chapter 1.2</p>	
	Visually inspect all keys	<ul style="list-style-type: none"> • If dirty – Clean parts as necessary. • If unacceptably scratched or damaged – Replace damaged parts as necessary. <p>NOTE: Misuse is not covered by warranty. Refer to chapter 1.2</p>	   

Problem Area	Items to Check	Repair Action	Reference Image
			
	Visually inspect for improper gap between seams	<ul style="list-style-type: none"> • Reassemble or replace damaged parts as necessary. 	

3 Network/Signal Problems

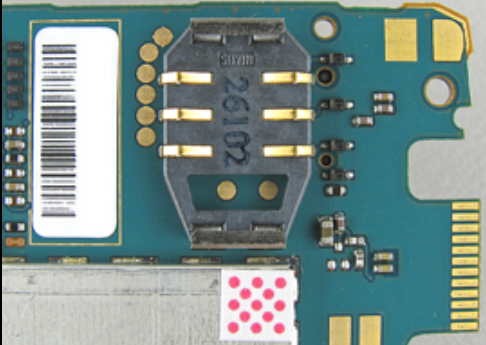
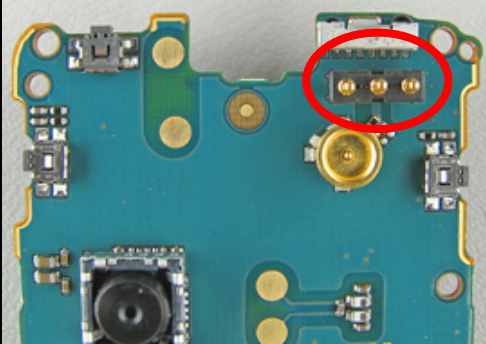
Problem Area	Items to Check	Repair Action	Reference Image
No Signal or Poor Signal	Before proceeding →	Perform a flash upgrade.	
	Visually inspect SIM holder	<ul style="list-style-type: none"> • If dirty or oxidized – Clean it. • If damaged – Send to an electrical repair location. 	
	Visually inspect antenna contact pads	<ul style="list-style-type: none"> • If dirty or oxidized – Clean the pads and replace the frame (B cover). 	

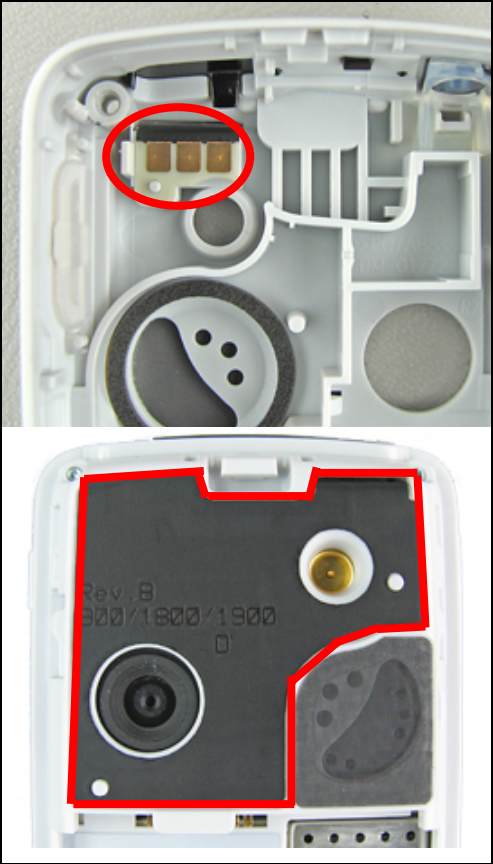
Problem Area	Items to Check	Repair Action	Reference Image
	Visually inspect antenna	<ul style="list-style-type: none"> • If dirty or oxidized – Replace the frame (B cover). • If damaged – Replace the frame (B cover). 	
	If the issue has not been resolved →	<ul style="list-style-type: none"> • Handle the unit according to local directives. 	

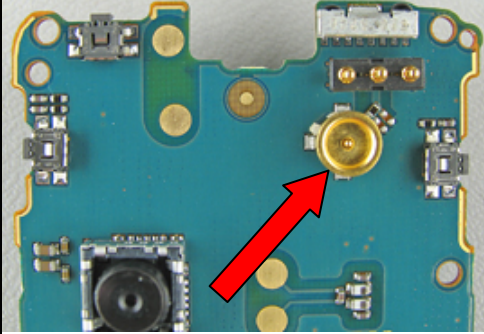

Problem Area	Items to Check	Repair Action	Reference Image
No signal when using external antenna (ex. Hands free in car).	Connect the phone to a handsfree car kit connected with external antenna. Visually inspect the antenna bar on the phone.	<ul style="list-style-type: none"> If no or only very less signal – Push the middle pin of the ext. antenna connector a few times. <p>Note: Be gently it might damage the connector.</p>	
	If the issue has not been resolved →	<ul style="list-style-type: none"> Handle the unit according to local directives. 	

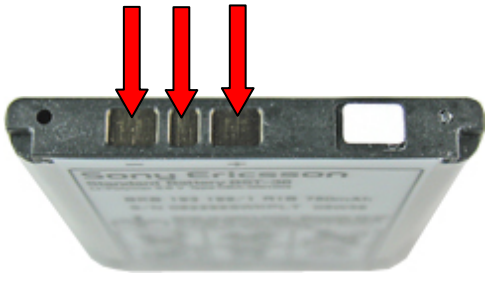
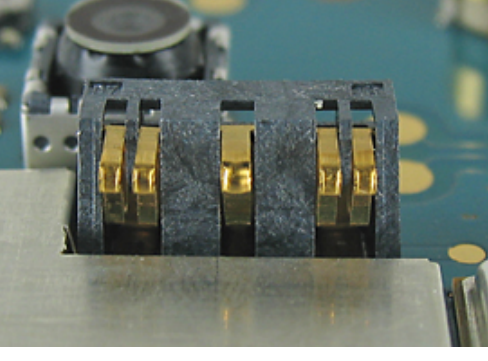

4 On/Off Problems



Problem Area	Items to Check	Repair Action	Reference Image
Power On problems	Check whether the phone vibrates 10 to 15 seconds after pressing the power key and whether the keypad illuminates	<ul style="list-style-type: none"> If activation of the vibrator or keypad are detected, refer to the “Display Problems” chapter 7 	
	Before proceeding →	<ul style="list-style-type: none"> Perform a flash upgrade. 	
	Visually inspect contact pads on battery	<ul style="list-style-type: none"> If dirty or oxidized – Clean pads. If damaged – Replace the battery. 	
	Visually inspect battery connector	<ul style="list-style-type: none"> If dirty or oxidized – Clean it. <p>Note: Be gentle do not bend or damage the gold surface on connector pin's</p> <ul style="list-style-type: none"> If damaged – Send to an electrical repair location. 	



Problem Area	Items to Check	Repair Action	Reference Image
	Visually inspect the power key	<ul style="list-style-type: none"> If damaged – Replace it. 	
	If the issue has not been resolved →	<ul style="list-style-type: none"> Handle the unit according to local directives. 	

5 Audio Problems

Problem Area	Items to Check	Repair Action	Reference Image
Microphone:	Before proceeding →	<ul style="list-style-type: none"> Perform a flash upgrade and a setting reset. 	
	Visually inspect the microphone's external port	<ul style="list-style-type: none"> If clogged - Clean or replace frame (B cover). 	
	If the issue has not been resolved →	<ul style="list-style-type: none"> Replace the microphone 	
	If the issue has not been resolved →	<ul style="list-style-type: none"> Handle the unit according to local directives. 	
Receiver: No sound or poor	Before proceeding →	<ul style="list-style-type: none"> Perform a flash upgrade and a setting reset. 	

Problem Area	Items to Check	Repair Action	Reference Image
quality sound	Visually inspect receiver's external port	<ul style="list-style-type: none"> If clogged – Clean or replace Front cover. 	
	Visually inspect receiver's dust cloth	<ul style="list-style-type: none"> If dirty or damaged – Replace front cover. 	
	Visually inspect the audio cover	<ul style="list-style-type: none"> If damaged – replace it. 	
	Visually inspect the pogo pins	<ul style="list-style-type: none"> If missing or damaged – Replace them. 	
	If the issue has not been resolved →	<ul style="list-style-type: none"> Replace receiver. 	

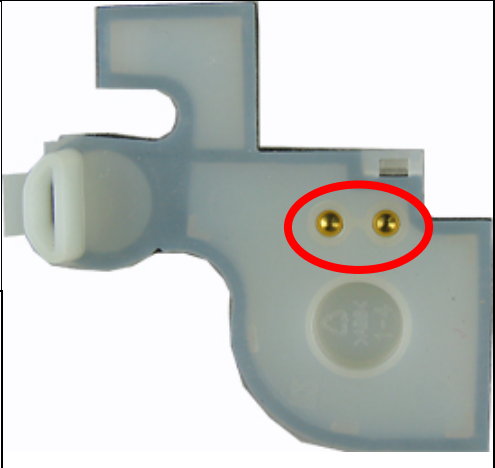
Problem Area	Items to Check	Repair Action	Reference Image
	If the issue has not been resolved →	<ul style="list-style-type: none"> Handle the unit according to local directives. 	
Speaker: No sound or poor quality sound	Before proceeding →	<ul style="list-style-type: none"> Perform a flash upgrade and a setting reset. 	
	Visually inspect speaker's external port	<ul style="list-style-type: none"> If clogged – Clean it. 	
	Visually inspect the speaker's dust cloth	<ul style="list-style-type: none"> If dirty or damaged – frame (B cover). 	

Problem Area	Items to Check	Repair Action	Reference Image
	Visually inspect the audio cover	<ul style="list-style-type: none"> If damaged – replace it. 	
	Visually inspect the pogo pins	<ul style="list-style-type: none"> If missing or damaged – Replace them. 	
	If the issue has not been resolved →	<ul style="list-style-type: none"> Replace loudspeaker. 	
	If the issue has not been resolved →	<ul style="list-style-type: none"> Handle the unit according to local directives. 	

6 Key Problems

Problem Area	Items to Check	Repair Action	Reference Image
<p>Keyboard:</p> <p>A key on the keyboard is not functioning or is intermittent</p>	<p>Visually inspect for debris between keypad and dome sheet and for damage to the keypad and the dome sheet.</p>	<ul style="list-style-type: none"> • If dirty – Clean both parts. • If damaged - Replace keypad and/or dome sheet as necessary. 	

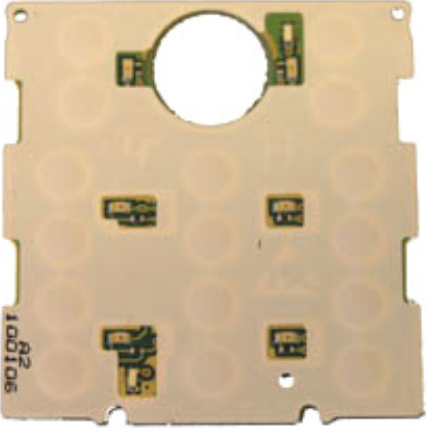
Problem Area	Items to Check	Repair Action	Reference Image
	If the issue has not been resolved →	<ul style="list-style-type: none"> Replace the dome sheet, if it has not already been replaced. 	
	If the issue has not been resolved →	<ul style="list-style-type: none"> Handle the unit according to local directives. 	

Problem Area	Items to Check	Repair Action	Reference Image
Side keys	Visually inspect for damage to the side keys	<ul style="list-style-type: none"> If damaged - Replace keys as necessary. 	
	If the issue has not been resolved →	<ul style="list-style-type: none"> Handle the unit according to local directives. 	

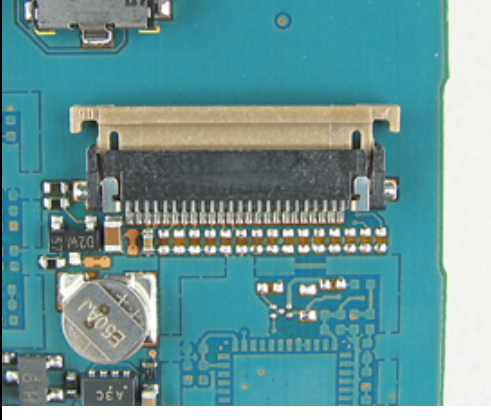

7 Display Problems

Problem Area	Items to Check	Repair Action	Reference Image
LCD problem	Check whether the phone vibrates 10 to 15 seconds after pressing the power key and whether the keypad illuminates	<ul style="list-style-type: none"> If activation of the vibrator are not detected, refer to the On/Off Problems” chapter 4 	
	Before proceeding →	<ul style="list-style-type: none"> Perform a flash upgrade and a setting reset. 	
	If only background illuminates and no text or picture in the display.	<ul style="list-style-type: none"> Do software update content refresh. Note: This problem will not be solved be a regular software update. Note: Software Update Content Refresh will erase all user data. 	
	Visually inspect whether the LCD flex film is properly connected to its connector on the PCB	<ul style="list-style-type: none"> If improperly connected – Re-establish proper connection. 	



Problem Area	Items to Check	Repair Action	Reference Image
	If the issue has not been resolved →	<ul style="list-style-type: none"> Replace the LCD. 	

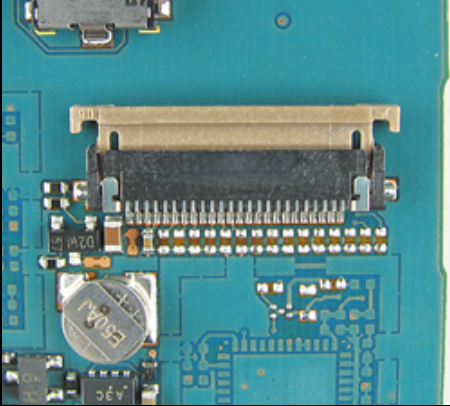

8 Illumination Problems

Problem Area	Items to Check	Repair Action	Reference Image
Keys: The entire keypad or a portion of the keypad does not illuminate.	Before proceeding →	<ul style="list-style-type: none"> Perform a flash upgrade and a setting reset. 	
	Visually inspect the dome sheet.	<ul style="list-style-type: none"> If damaged – Replace it 	
	If the issue has not been resolved →	<ul style="list-style-type: none"> Replace the dome sheet. 	

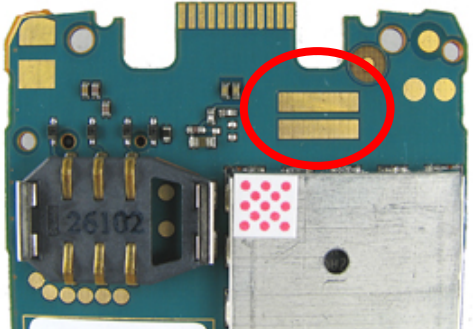
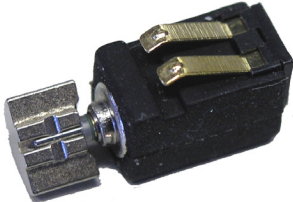
Problem Area	Items to Check	Repair Action	Reference Image
	If the issue has not been resolved →	<ul style="list-style-type: none"> Handle the unit according to local directives. 	
LCD	Before proceeding →	<ul style="list-style-type: none"> Perform a flash upgrade and a setting reset. 	
	Visually inspect whether the LCD flex film is properly connected to its connector on the PCB	<ul style="list-style-type: none"> If improperly connected – Re-establish proper connection. 	
	If issue has not been resolved →	<ul style="list-style-type: none"> Replace the LCD. 	
	If the issue has not been resolved →	<ul style="list-style-type: none"> Handle the unit according to local directives. 	

9 Alert Problems

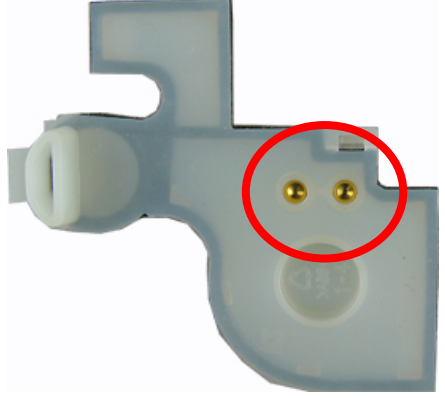
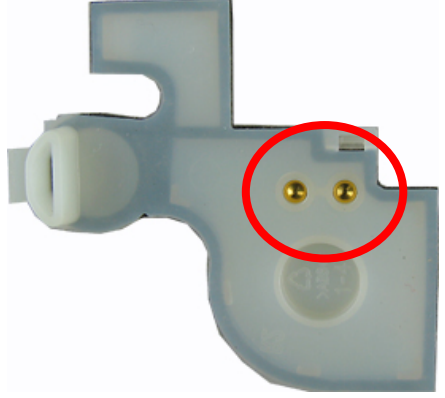

Problem Area	Items to Check	Repair Action	Reference Image
Vibrator:	Before proceeding →	<ul style="list-style-type: none"> Perform a flash upgrade and a setting reset. 	
	Visually inspect the vibrator pads on the PCB	<ul style="list-style-type: none"> If dirty or oxidized – Clean them. 	
	Visually inspect the vibrator	<ul style="list-style-type: none"> If dirty or oxidized – Replace it. If damaged – Replace it. 	
Speaker: No sound or poor quality sound	Before proceeding →	<ul style="list-style-type: none"> Perform a flash upgrade and a setting reset. 	
	Visually inspect speaker's external port	<ul style="list-style-type: none"> If clogged – Clean it. 	

Problem Area	Items to Check	Repair Action	Reference Image
	Visually inspect the speaker's dust cloth	<ul style="list-style-type: none"> If dirty or damaged – frame (B cover). 	
	Visually inspect the audio cover	<ul style="list-style-type: none"> If damaged – replace it. 	
	Visually inspect the pogo pins	<ul style="list-style-type: none"> If missing or damaged – Replace them. 	
	If the issue has not been resolved →	<ul style="list-style-type: none"> Replace loudspeaker. 	

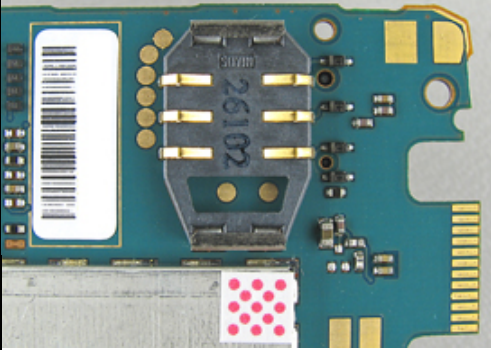
10 SIM Problems

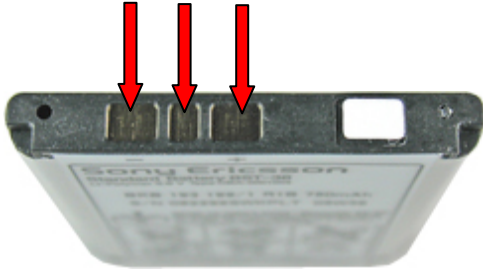

Problem Area	Items to Check	Repair Action	Reference Image
SIM undetected (Insert SIM)	Inspect SIM holder	<ul style="list-style-type: none"> If dirty or oxidized – Clean. If damaged – Send to an electrical repair location. 	
	If the issue has not been resolved →	<ul style="list-style-type: none"> Handle the unit according to local directives. 	
Unit indicates an incorrect SIM is inserted (Insert correct SIM)	Check whether the phone is locked to a particular carrier and whether the correct carrier's SIM is being used	<ul style="list-style-type: none"> Use Correct Carrier SIM or test SIM. 	
	If the issue has not been resolved →	<ul style="list-style-type: none"> Handle the unit according to local directives. 	

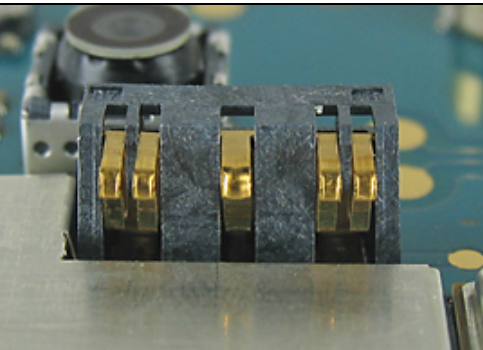
11 Charging/Capacity Problems

Problem Area	Items to Check	Repair Action	Reference Image
Battery will not charge	Visually inspect the contact pads of the battery	<ul style="list-style-type: none"> If dirty or oxidized – Clean. If damaged – Replace battery. 	
	Visually inspect the system connector	<ul style="list-style-type: none"> If dirty, oxidized or damaged – Clean or replace. <p>NOTE: Misuse is not covered by warranty. Refer to chapter 1.2</p>	
	Visually inspect the battery connector	<ul style="list-style-type: none"> If dirty or oxidized – Clean. If damaged – Send to an electrical repair location. 	

Battery loses charge quickly/ standby time seems short	Before proceeding →	<ul style="list-style-type: none"> Perform a flash upgrade and a setting reset. 	
	<p>NOTE: Some features noticeably reduce the amount of standby time if they are turned on. Some examples are the back light (when on all the time and), Bluetooth and infrared.</p>		
	If the issue has not been resolved →	<ul style="list-style-type: none"> Replace battery. 	
	If the issue has not been resolved →	<ul style="list-style-type: none"> Handle the unit according to local directives. 	

12 Camera Problems

Problem Area	Items to Check	Repair Action	Reference Image
Camera Lines, marks, blurred or discolored picture	Visually inspect the camera lens	<ul style="list-style-type: none"> If scratched or damaged – Replace the camera 	
	Visually inspect whether the camera is properly connected to its socket on the PCB.	<ul style="list-style-type: none"> If improperly connected – Re-establish proper connection. 	
	If the issue has not been resolved →	<ul style="list-style-type: none"> Replace the camera. 	
Will not capture an image	Visually inspect for damage to the camera key	<ul style="list-style-type: none"> If damaged - Replace the camera key if necessary. 	
	If the issue has not been resolved →	<ul style="list-style-type: none"> Replace camera. 	
	If the issue has not been resolved →	<ul style="list-style-type: none"> Handle the unit according to local directives. 	

13 Data Communication Problems

Problem Area	Items to Check	Repair Action	Reference Image
Will not connect with a functional IR device	Before proceeding →	<ul style="list-style-type: none"> Perform a flash upgrade and a setting reset. 	
	Visually inspect the IRDA window for dirt, scratches, and damage	<ul style="list-style-type: none"> If dirty – Clean it. If damaged – Replace it. 	
	If the issue has not been resolved →	<ul style="list-style-type: none"> Handle the unit according to local directives. 	

14 Software Problems

- If there are problems with the response of the keypad commands, or spelling errors in the menu, if they are not related to mechanical damage, make a master reset and flash the phone with the latest software from EMMA II or III.
- Checking the software revision can be done in the Service info, see chapter *Service functions in the software*.
Choose: Service info / SW information.
The Software revision and date will be shown in the display.

Note: Do a SW upgrade before sending the unit to a higher level. Do **not** scrap a phone that hasn't been upgraded.

If the failure still occurs, handle the unit according to the local directives.

15 Revision History

Rev.	Date	Changes / Comments
A	2006-06-16	First release
B	2006-10-22	Chapter Display Problems updated
C	2006-11-10	Due to system problem. No changes made on content.