

Confidential
Approved according to 00021-LXE 107 42/1

KRETSSHEMA CIRCUIT DIAGRAM

Sony Ericsson	SEM/BGUBDF Turan Caliskan	Uppgjort/aven/taakansvarig an annan - Prepared (also subject responsible if other)
Toleranser - Tolerances	Dokumentansvarig/Godkand - Document responsible/Approved	Datum - Date
Application & Sys.Performance	SEM/BGURBDF Kent Pålsson	2007-08-06
Tilbor - Made for	Perf&Apps Top	Rev 3
Produktbenämning - Product name	Sofia	
Dokumentnr - Document nr	1200-1887	Bild - Sheet B
Ritningsregler - Drawing rules		1 of 15

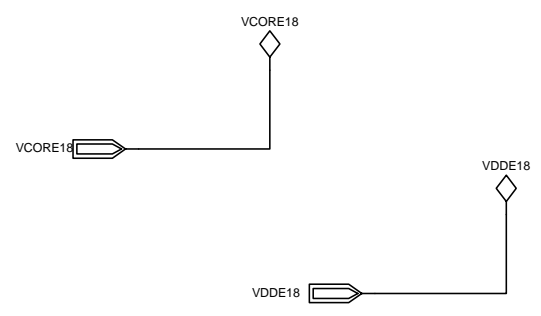
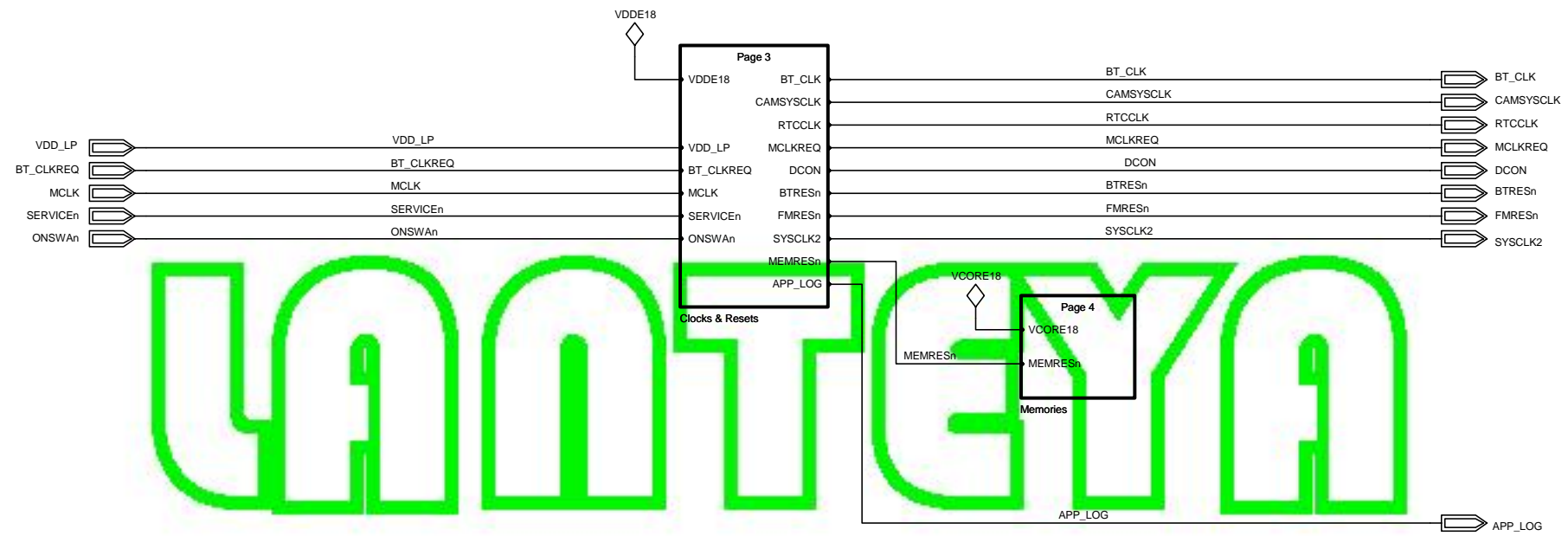

Confidential
 Approved according to 00021-LXE 107 42/1 SCHEMA DIAGRAM

Sony Ericsson		Uppgörd (även faktaansvarig om annan) - Prepared (also subject responsible if other)	
Toleranser - Tolerances Application & Sys.Performance		Dokumentansvarig/Godkänd - Document responsible/Approved SEM/BGUBDF Turan Caliskan	
Tillhör - Made for System Top		Datum - Date 2007-08-06	Rev 3
Ritningsregler - Drawing rules		Produktbenämning - Product name Sofia	
AcePlus		Dokumentnr - Document nr 1200-1887	Blad - Sheet B 2 of 15

LZF 030 102/F RB

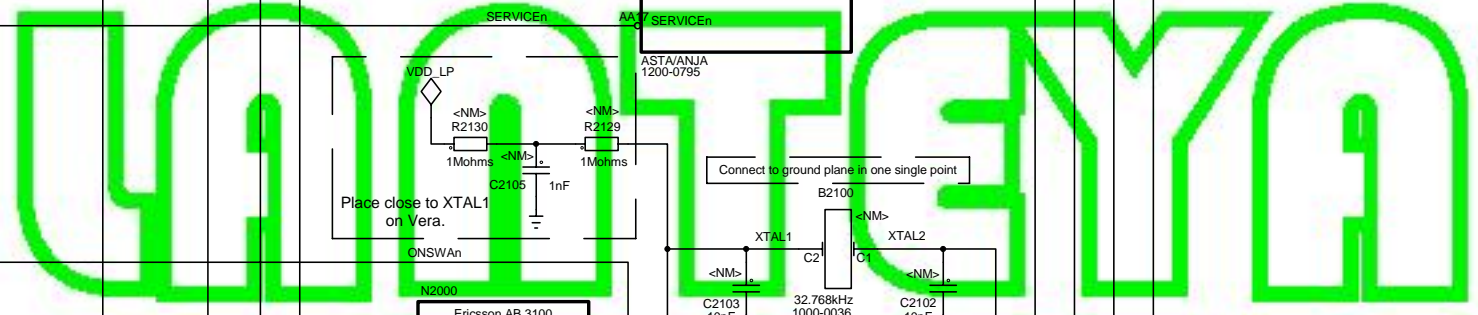
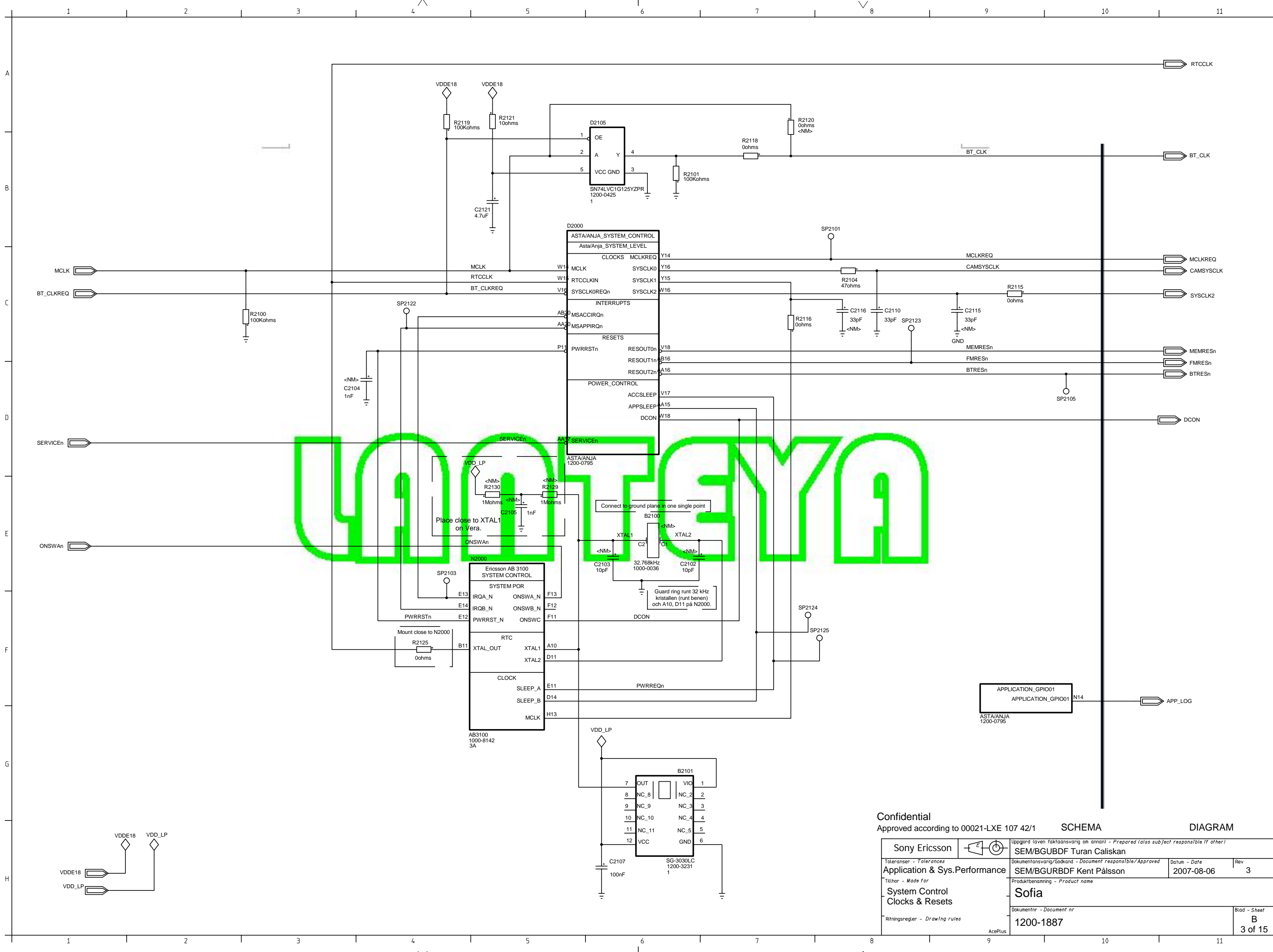

Confidential
Approved according to 00021-LXE 107 42/1

SCHEMA **DIAGRAM**

Sony Ericsson	<small>Uppgord (även faktaansvarig om annan) - Prepared (also subject responsible if other)</small> SEM/BGUBDF Turan Caliskan	<small>Dokumentansvarig/Godkänd - Document responsible/Approved</small> SEM/BGURBDF Kent Pålsson
<small>Tillhör - Made for</small> System Control Clocks & Resets	<small>Datum - Date</small> 2007-08-06	<small>Rev</small> 3
<small>Ritningsregler - Drawing rules</small>	<small>Produktbenämning - Product name</small> Sofia	<small>Blad - Sheet</small> B
	<small>Dokumentnr - Document nr</small> 1200-1887	<small>3 of 15</small>

LZF 030 102/F RB

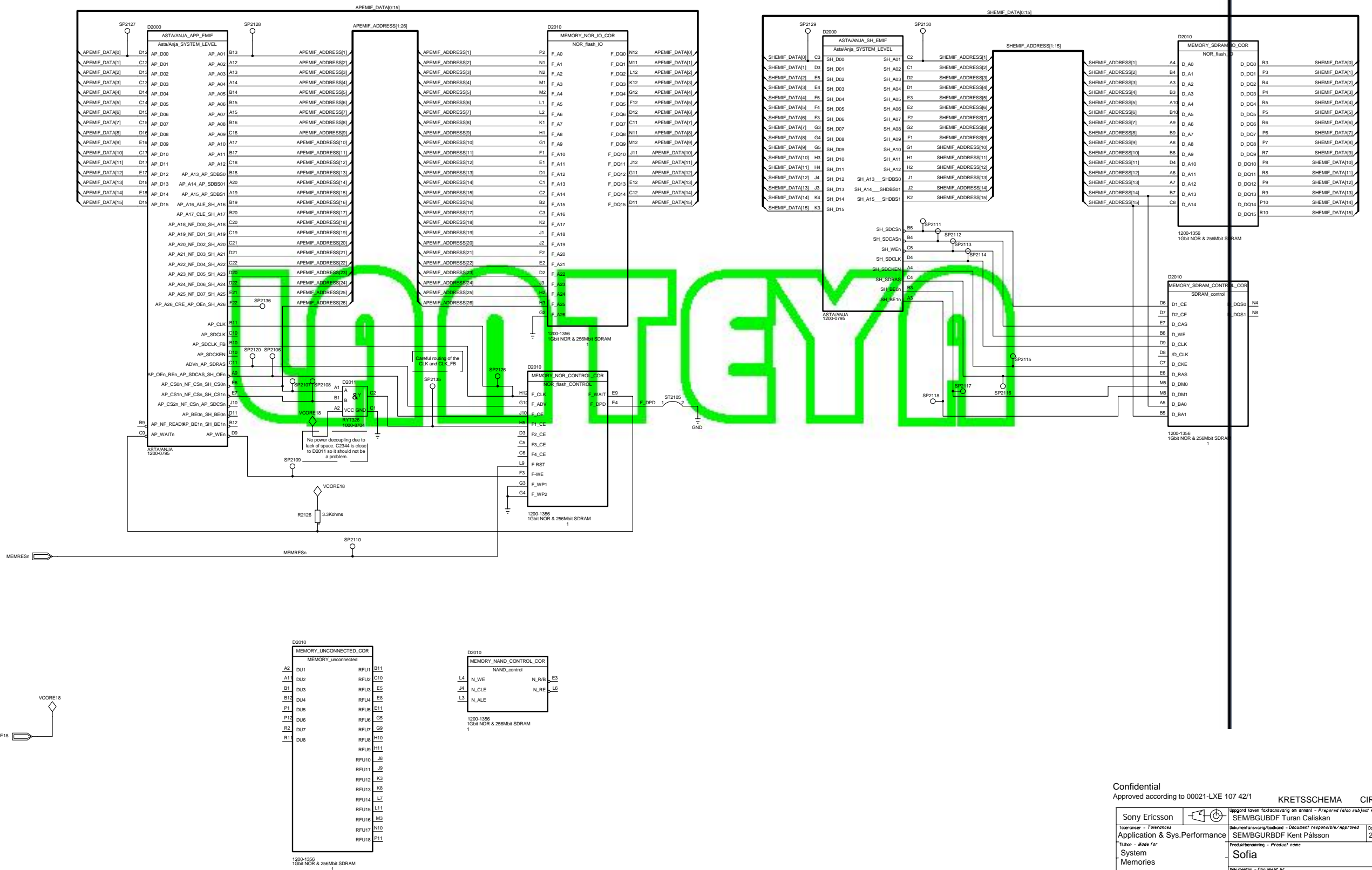

Confidential
Approved according to 00021-LXE 107 42/1

KRETSSHEMA CIRCUIT DIAGRAM

Sony Ericsson
Application & Sys.Performance
Tailor - Made for
System
Memories

SEM/BGUBDF Turan Caliskan
SEM/BGURBDF Kent Pålsson
Sofia
1200-1887

Approved (given Taktsvaring an annan) - Prepared (also subject responsible if other)
SEM/BGUBDF Turan Caliskan
SEM/BGURBDF Kent Pålsson
Sofia
1200-1887

Datum - Date	2007-08-06	Rev	3
Bild - Sheet	B		4 of 15

AcqPlus

LZF 030 101/F RB1

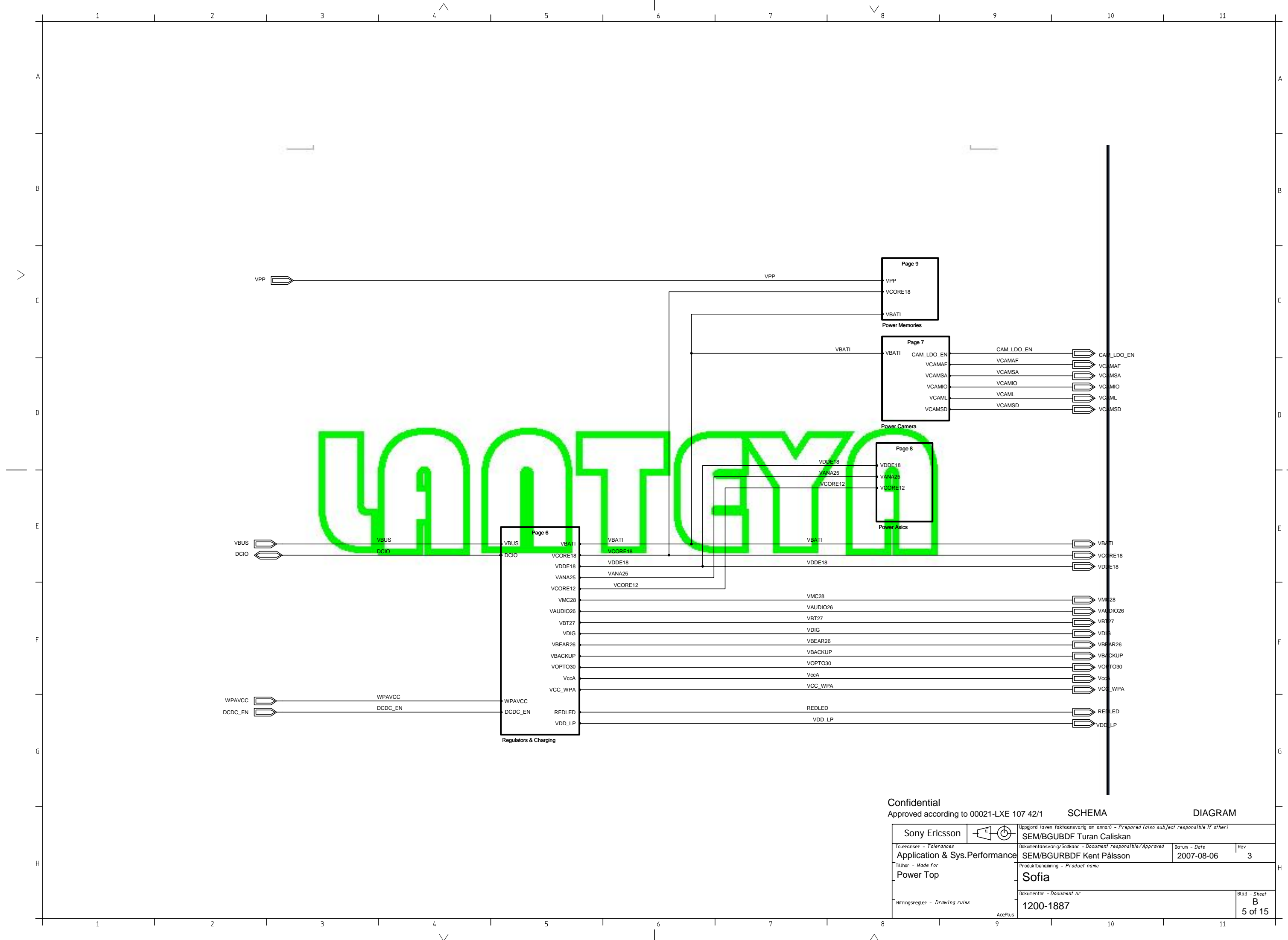

UNOTIFY

Confidential
 Approved according to 00021-LXE 107 42/1 SCHEMA DIAGRAM

		Uppgjord (även faktaansvarig om annan) - Prepared (also subject responsible if other) SEM/BGUBDF Turan Caliskan	
Toleranser - Tolerances Application & Sys.Performance	Dokumentansvarig/Godkänd - Document responsible/Approved SEM/BGURBDF Kent Pålsson	Datum - Date 2007-08-06	Rev 3
Tillhör - Made for Power Top	Produktbenämning - Product name Sofia		
Ritningsregler - Drawing rules	Dokumentnr - Document nr 1200-1887	Blad - Sheet B 5 of 15	

LZF 030 102/F RB

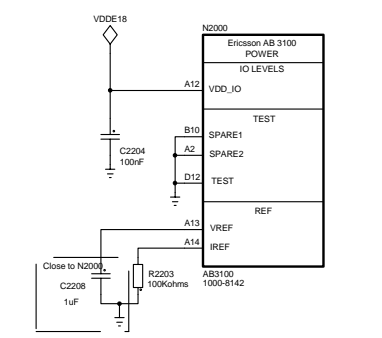
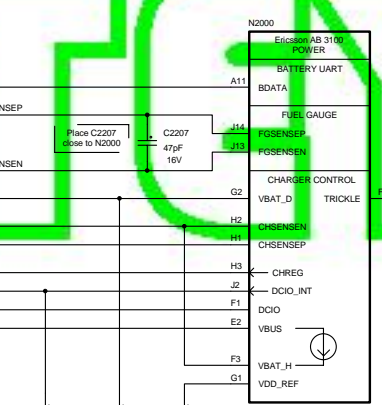
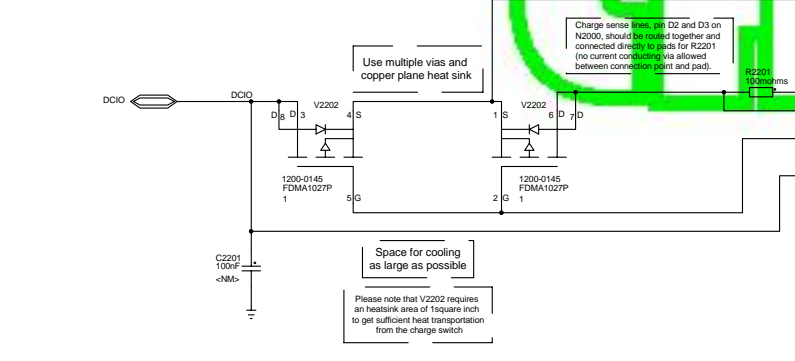
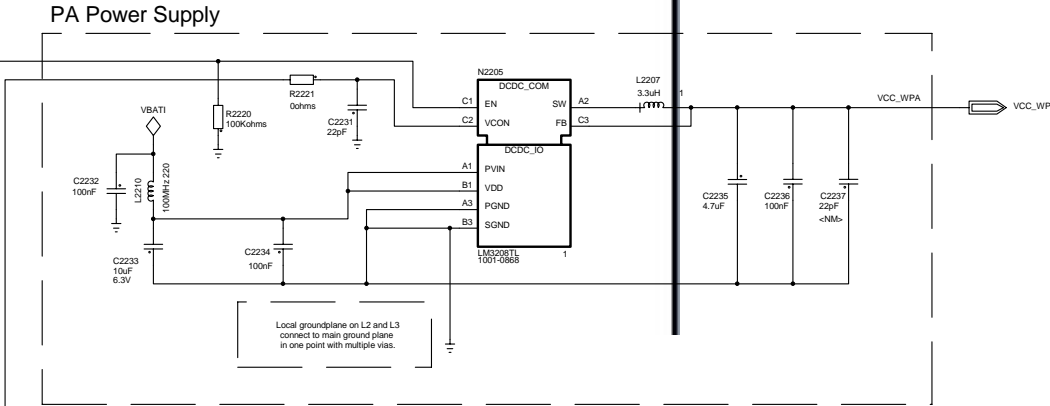
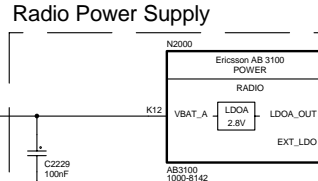
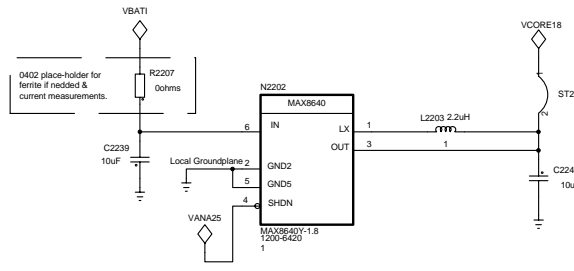
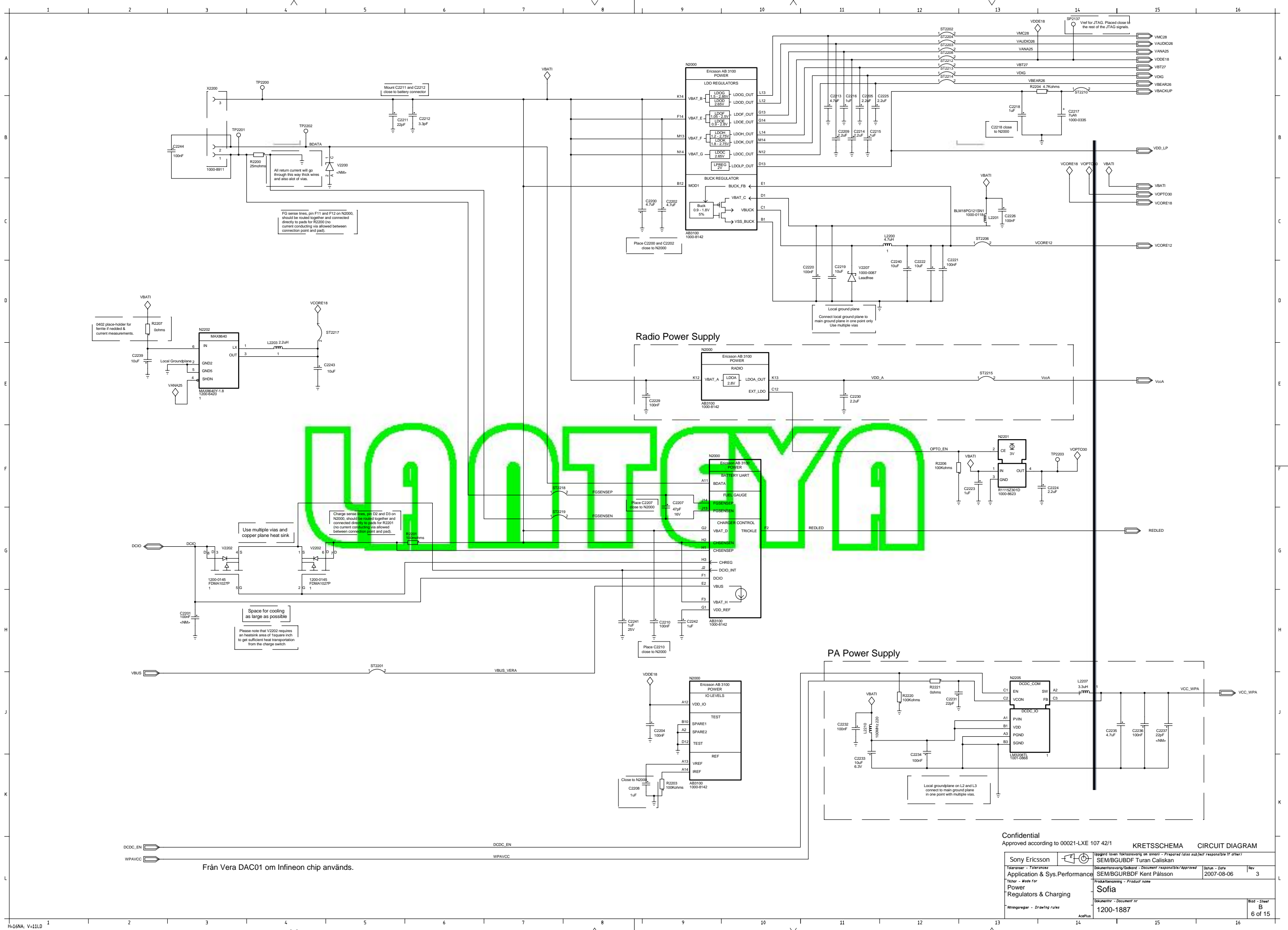

Confidential
Approved according to 00021-LXE 107 42/1

KRETSSCHEMA
CIRCUIT DIAGRAM

Toleranser - Tolerances	SEM/BGURBDF Turan Caliskan	Datum - Date	Rev
Application & Sys.Performance	SEM/BGURBDF Kent Pålsson	2007-08-06	3
Tilbud - Made for	Sofia		
Regulators & Charging	Sofia		
Ritningsregler - Drawing rules	1200-1887	Bild - Sheet	B
			6 of 15

Från Vera DAC01 om Infineon chip används.

LZF 030 101/F RB1

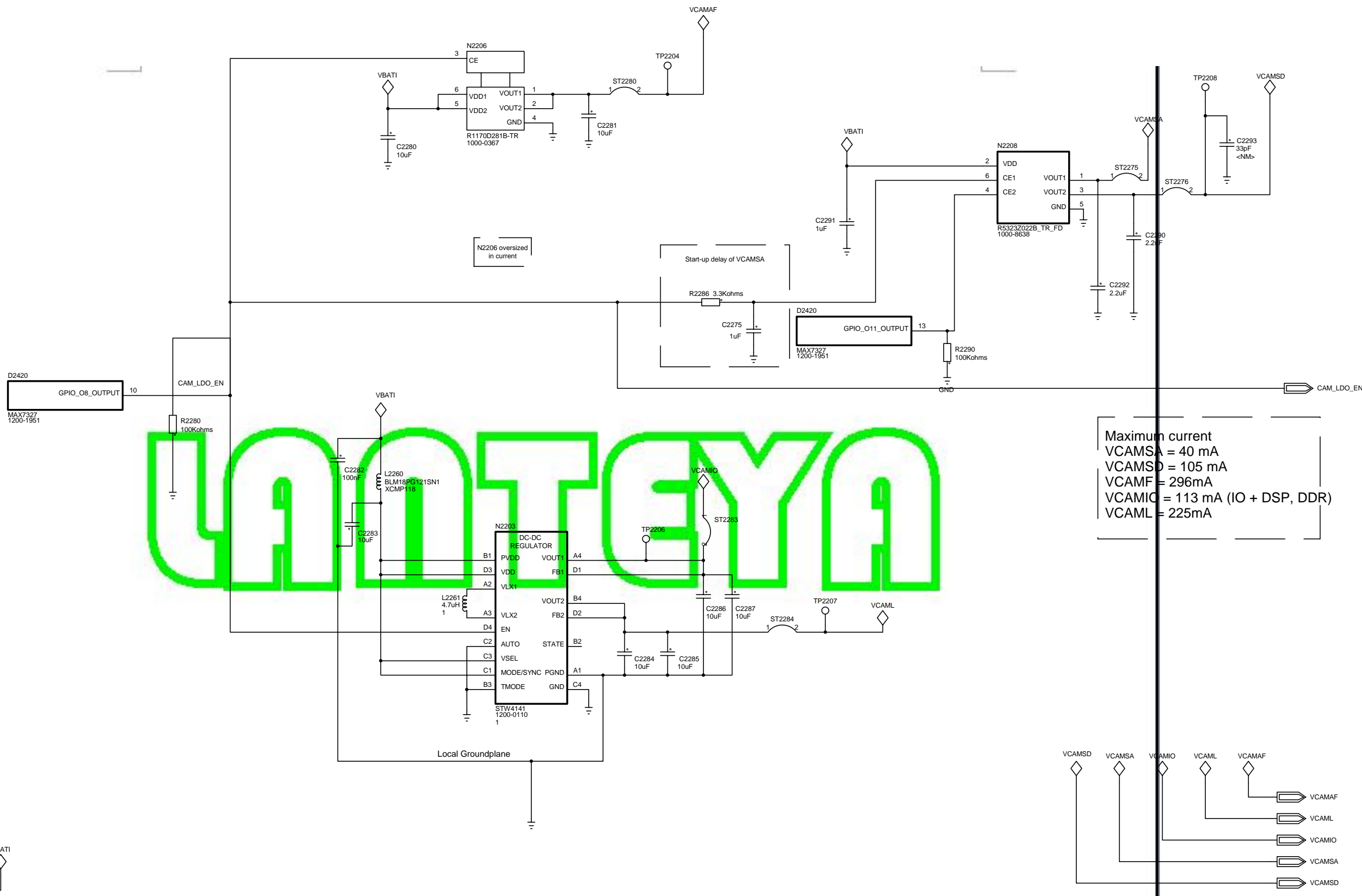

WANTOYA

Confidential Approved according to 00021-LXE 107 42/1		SCHEMA DIAGRAM	
Sony Ericsson  Uppgörd (även faktaansvarig om annan) - Prepared (also subject responsible if other)		SEM/BGUBDF Turan Caliskan	
Toleranser - Tolerances Application & Sys.Performance		Dokumentansvarig/Godkänd - Document responsible/Approved SEM/BGURBDF Kent Pålsson	
Tillhör - Made for Power Camera		Datum - Date 2007-08-06	
Ritningsregler - Drawing rules		Produktbenämning - Product name Sofia	
Rev 3		Dokumentnr - Document nr 1200-1887	
AcePlus		Blad - Sheet B 7 of 15	

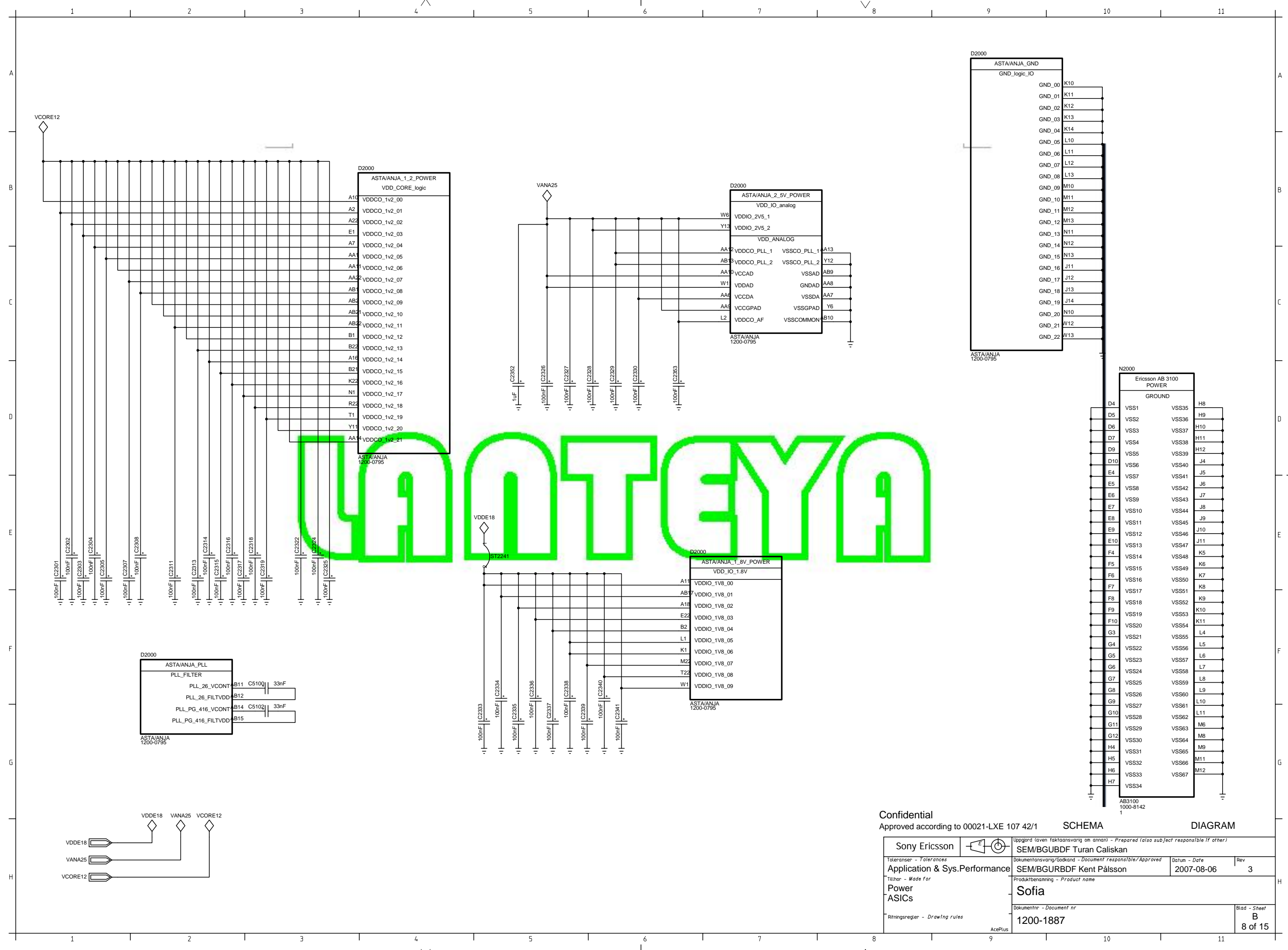

UNOTIFY

Confidential
Approved according to 00021-LXE 107 42/1

SCHEMA DIAGRAM

<p>Sony Ericsson</p> <p>Toleranser - Tolerances Application & Sys.Performance</p> <p>Tillhör - Made for Power ASICs</p> <p>Ritningsregler - Drawing rules</p>	<p>Uppgord (även faktaansvarig om annan) - Prepared (also sub/ject responsible if other)</p> <p>SEM/BGUBDF Turan Caliskan</p> <p>Dokumentansvarig/Godkänd - Document responsible/Approved SEM/BGURBDF Kent Pålsson</p> <p>Produktbenämning - Product name Sofia</p> <p>Dokumentnr - Document nr 1200-1887</p>	<p>Datum - Date 2007-08-06</p> <p>Rev 3</p> <p>Blad - Sheet B 8 of 15</p>
--	---	--

AcePlus

LZF 030 102/F RB

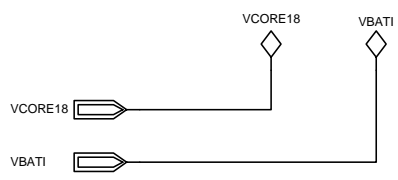
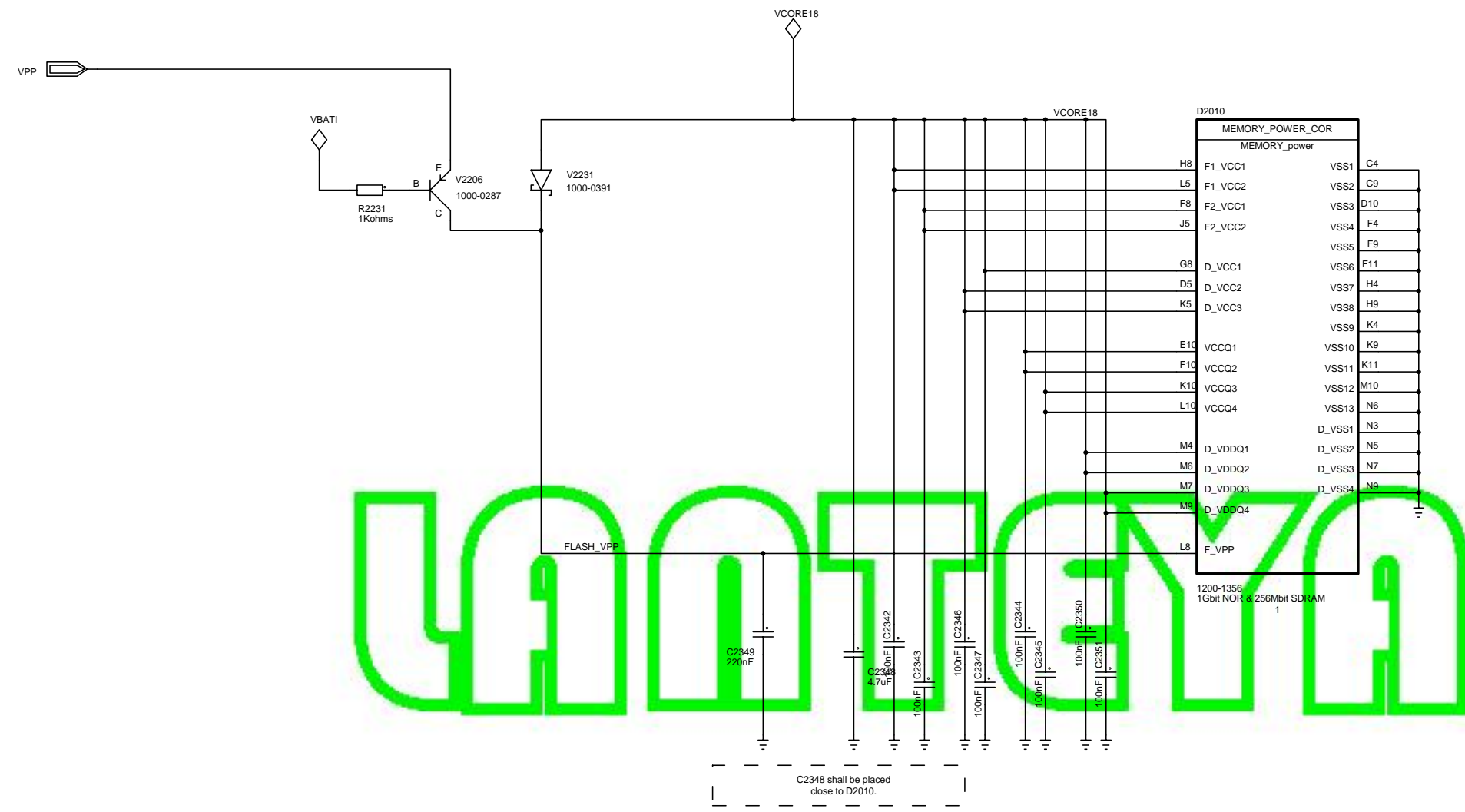

Confidential
 Approved according to 00021-LXE 107 42/1 SCHEMA DIAGRAM

Sony Ericsson		Uppgjord (även faktaansvarig om annan) - Prepared (also subject responsible if other)	
Toleranser - Tolerances Application & Sys.Performance		Dokumentansvarig/Godkänd - Document responsible/Approved SEM/BGUBDF Turan Caliskan	
Tillhör - Made for Power Memories		Datum - Date 2007-08-06	Rev 3
Ritningsregler - Drawing rules		Produktbenämning - Product name Sofia	
		Dokumentnr - Document nr 1200-1887	Blad - Sheet B 9 of 15

LZF 030 102/F RB

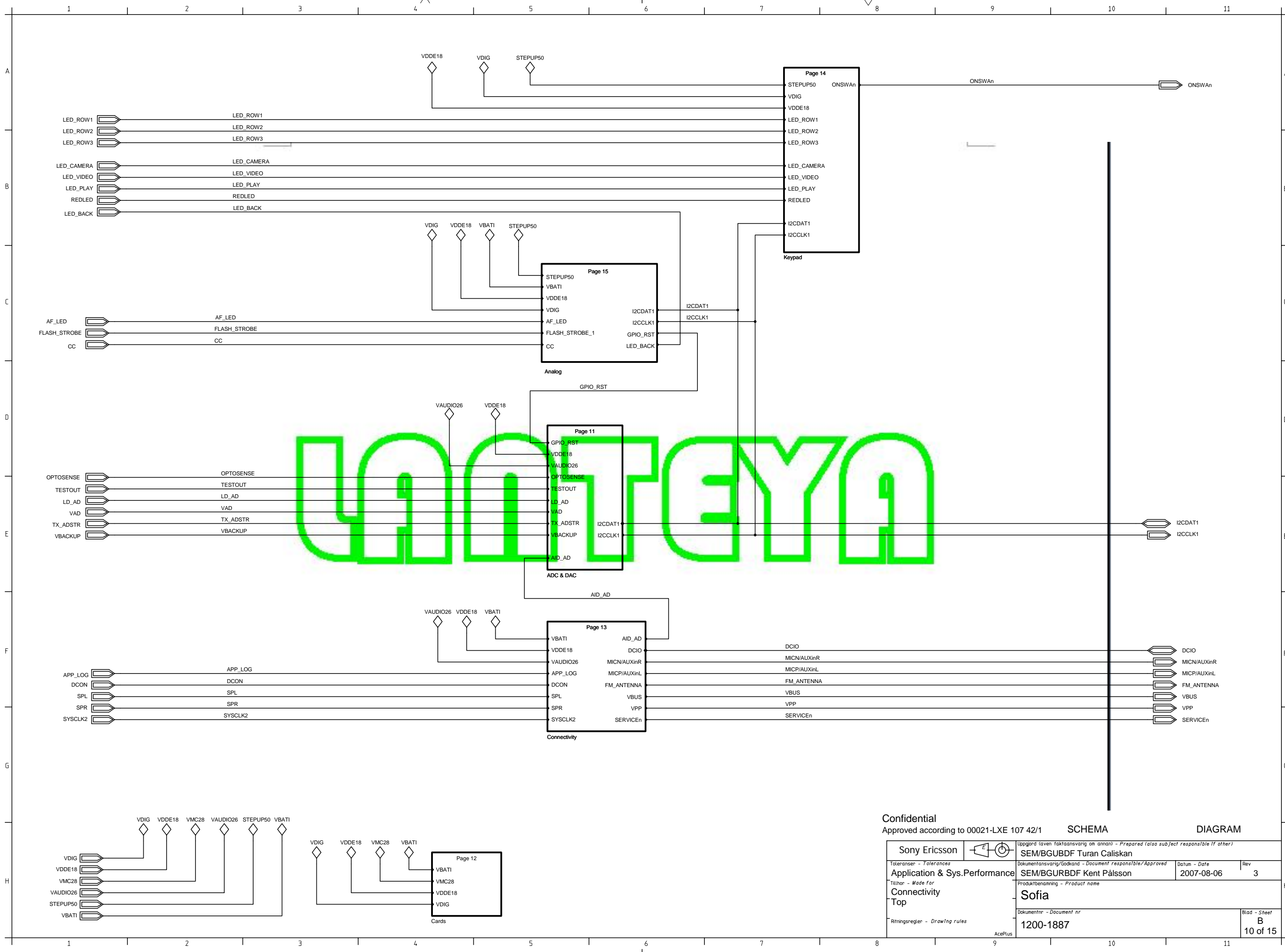

Confidential
 Approved according to 00021-LXE 107 42/1

SCHEMA **DIAGRAM**

Uppgörd (även faktaansvarig om annan) - Prepared (also subject responsible if other) SEM/BGUBDF Turan Caliskan		Datum - Date	Rev
Dokumentansvarig/Godkänd - Document responsible/Approved SEM/BGURBDF Kent Pålsson		2007-08-06	3
Tillhör - Made for Connectivity		Produktbenämning - Product name Sofia	
Ritningsregler - Drawing rules AcePlus		Blad - Sheet B 10 of 15	

1200-1887

LZF 030 102/F RB

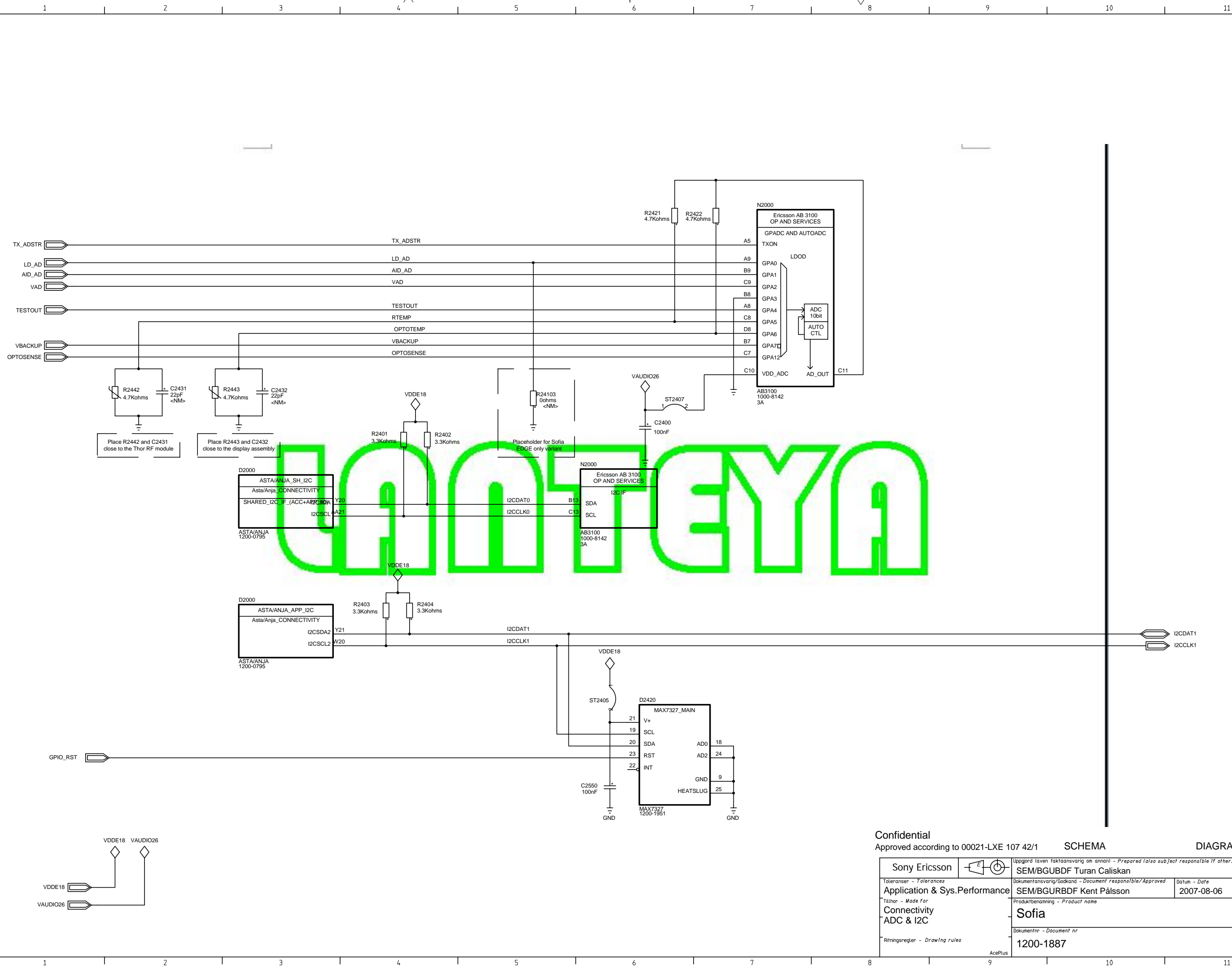

Confidential
Approved according to 00021-LXE 107 42/1 SCHEMA DIAGRAM

Sony Ericsson		Uppgjord (även faktaansvarig om annan) - Prepared (also subject responsible if other)	
Toleranser - Tolerances Application & Sys.Performance		Dokumentansvarig/Godkänd - Document responsible/Approved SEM/BGUBDF Turan Caliskan	
Tillhör - Made for Connectivity ADC & I2C		Datum - Date 2007-08-06	Rev 3
Ritningsregler - Drawing rules		Produktbenämning - Product name Sofia	
		Dokumentnr - Document nr 1200-1887	Blad - Sheet B 11 of 15

L2F 030 102/F RB

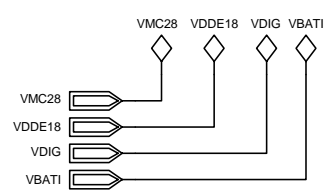
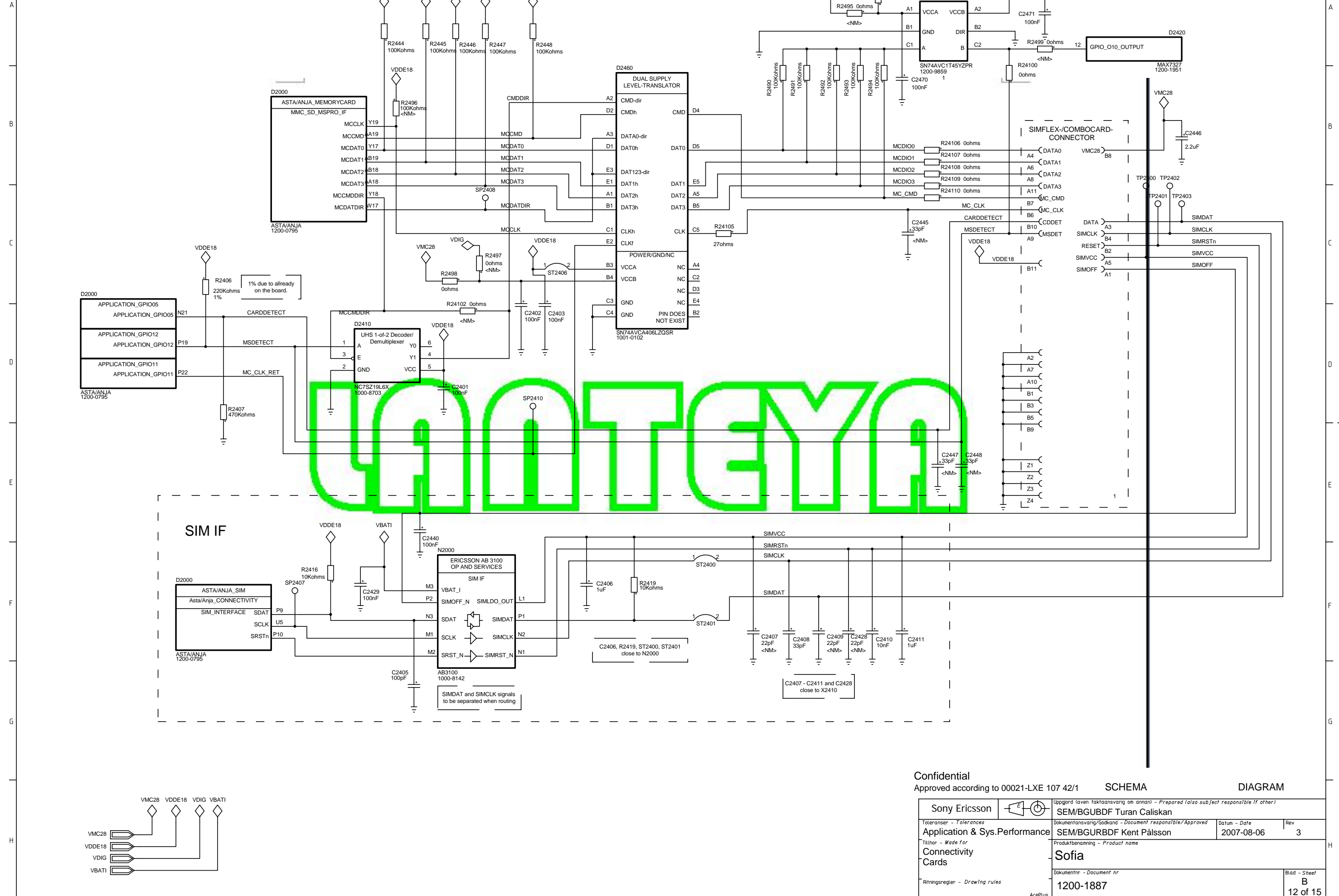

Confidential
 Approved according to 00021-LXE 107 42/1 SCHEMA DIAGRAM

Sony Ericsson Application & Sys.Performance Tillhör - Made for Connectivity Cards Ritningsregler - Drawing rules	Uppgord (aven faktaansvarig om annan) - Prepared (also sub)ject responsible if other) SEM/BGUBDF Turan Caliskan	Datum - Date	Rev
	Dokumentansvarig/Godkänd - Document responsible/Approved SEM/BGURBDF Kent Pålsson	2007-08-06	3
Produktbenämning - Product name Sofia		Dokumentnr - Document nr 1200-1887	
			Blad - Sheet B 12 of 15

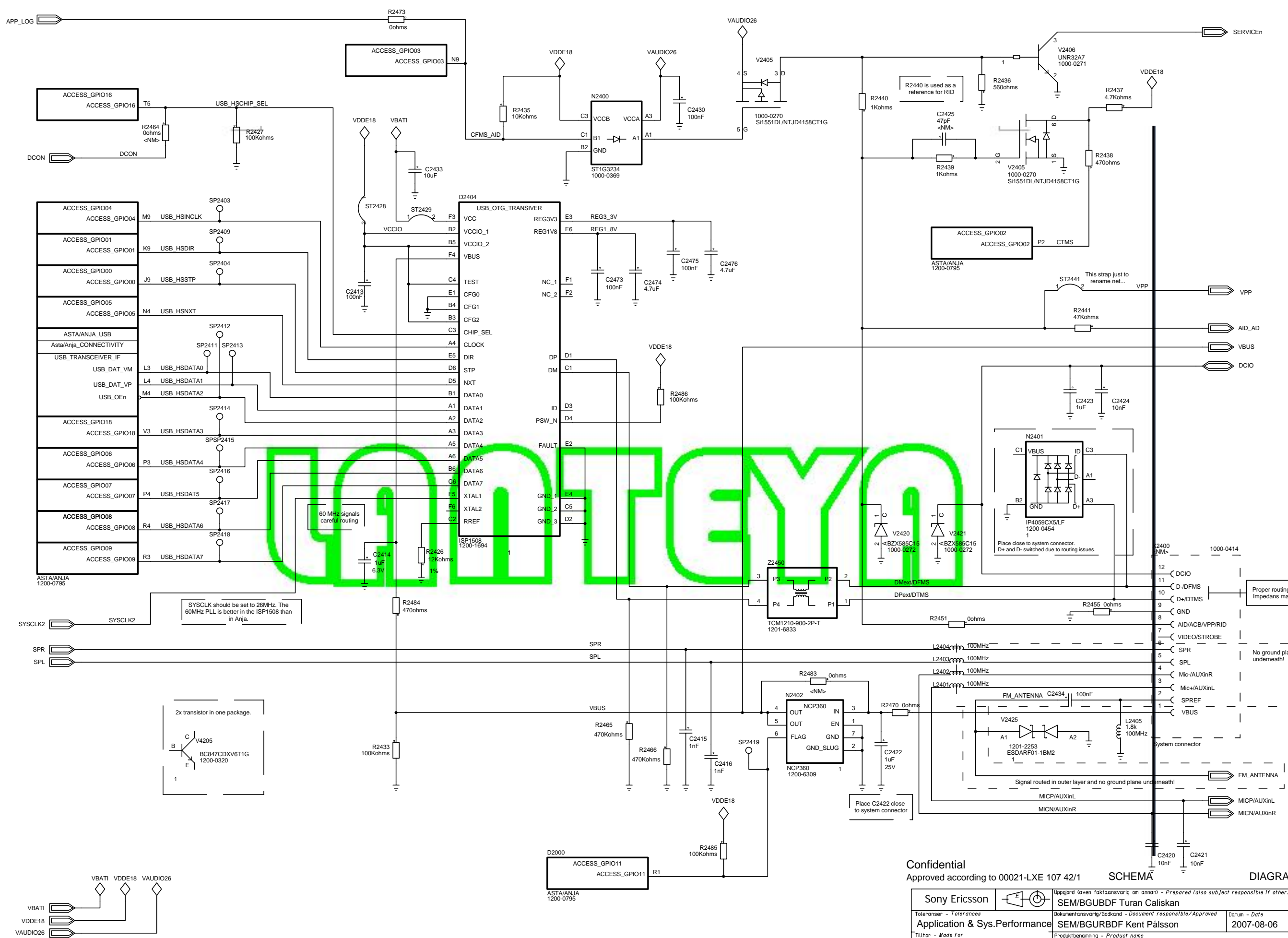

60 MHz signals careful routing

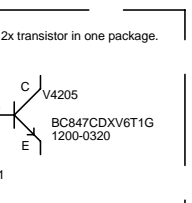

Proper routing on D+ and D- Impedans matched 90 Ohm.

No ground plane underneath!

Signal routed in outer layer and no ground plane underneath!

Confidential
Approved according to 00021-LXE 107 42/1

Sony Ericsson Uppgörd (aven faktaansvarig om annan) - Prepared (also sub)ject responsible if other	
Toleranser - Tolerances Application & Sys.Performance	Dokumentansvarig/Godkänd - Document responsible/Approved SEM/BGURBDF Kent Pålsson
Tillhör - Made for Connectivity Connectivity	Datum - Date 2007-08-06
Ritningsregler - Drawing rules AcePlus	Produktbenämning - Product name Sofia Dokumentnr - Document nr 1200-1887
	Blad - Sheet B 13 of 15

VDDE18 VDDE18 VDDE18 VDDE18 VDDE18 VDDE18

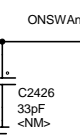
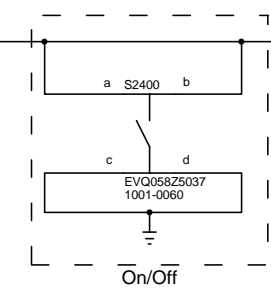
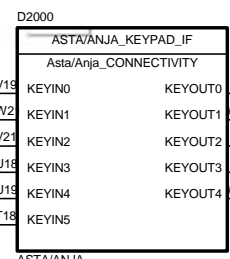
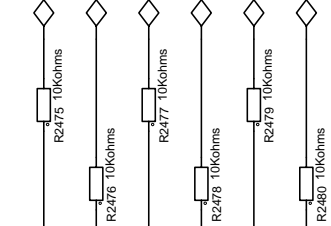

KEYFLEX-CONNECTOR

X2410 1200-1735

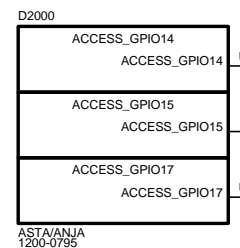
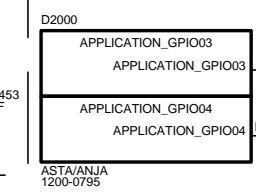
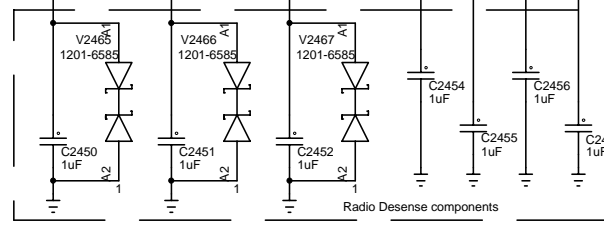
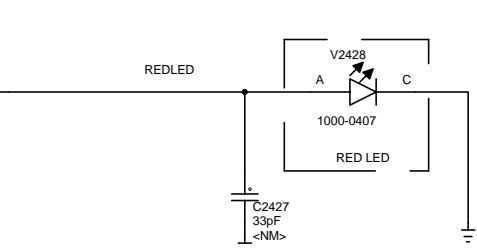
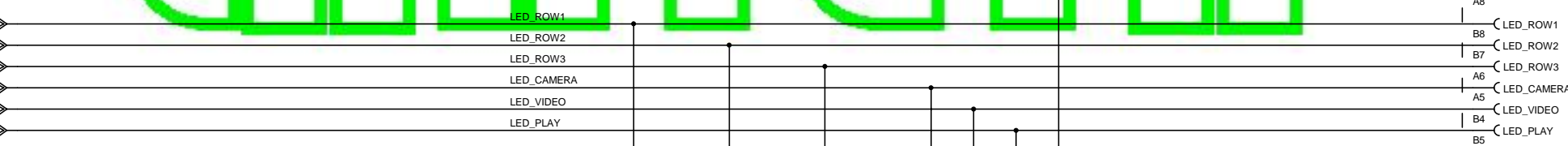
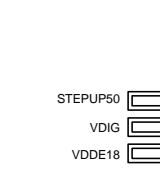
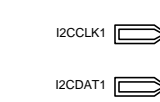
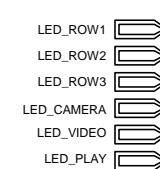
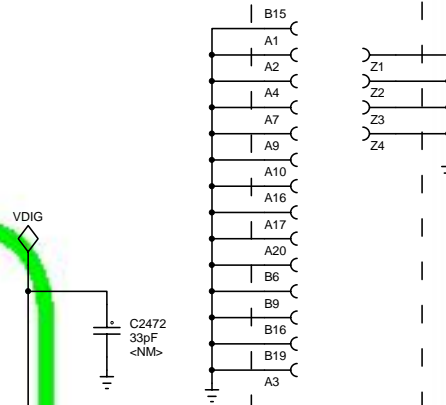
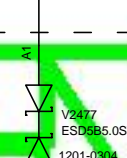
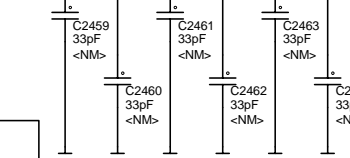
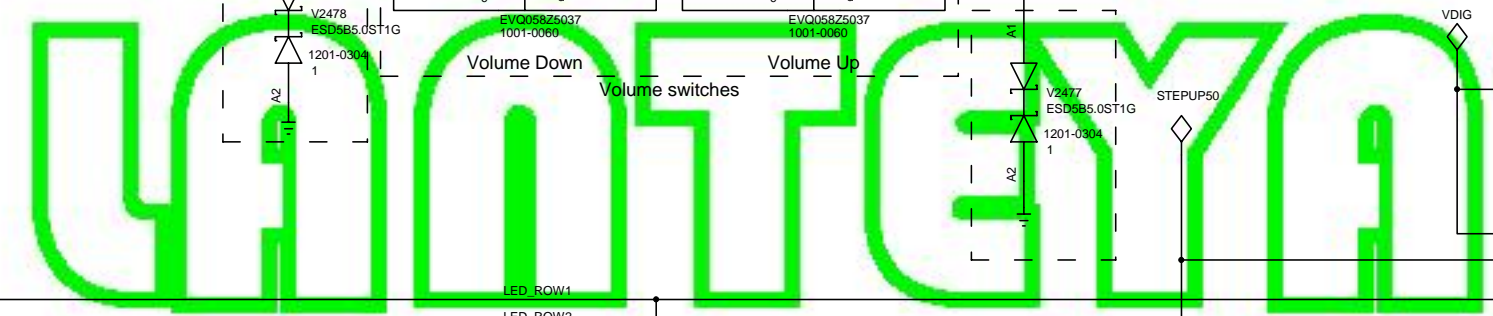
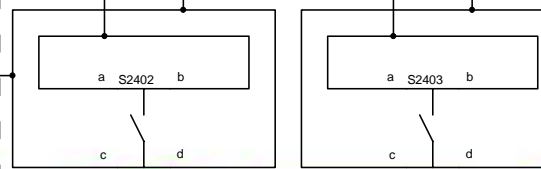
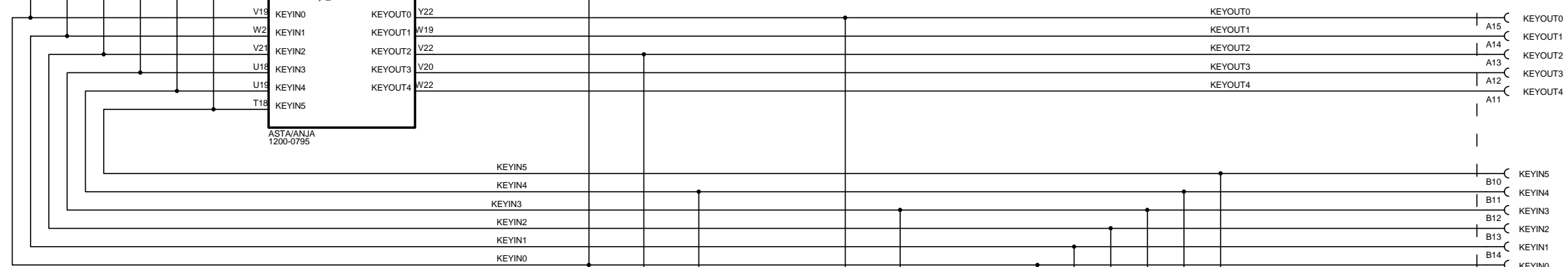

Confidential Approved according to 00021-LXE 107 42/1 Application & Sys. Performance Sony Ericsson

Upplagd (även faktaansvarig om annan) - Prepared (also subject responsible if other)	
SEM/BGUBDF Turan Caliskan	Dokumentansvarig/Godkänd - Document responsible/Approved
SEM/BGURBDF Kent Pålsson	Datum - Date 2007-08-06
Sofia	Rev 3
Dokumentnr - Document nr 1200-1887	Blad - Sheet B 14 of 15

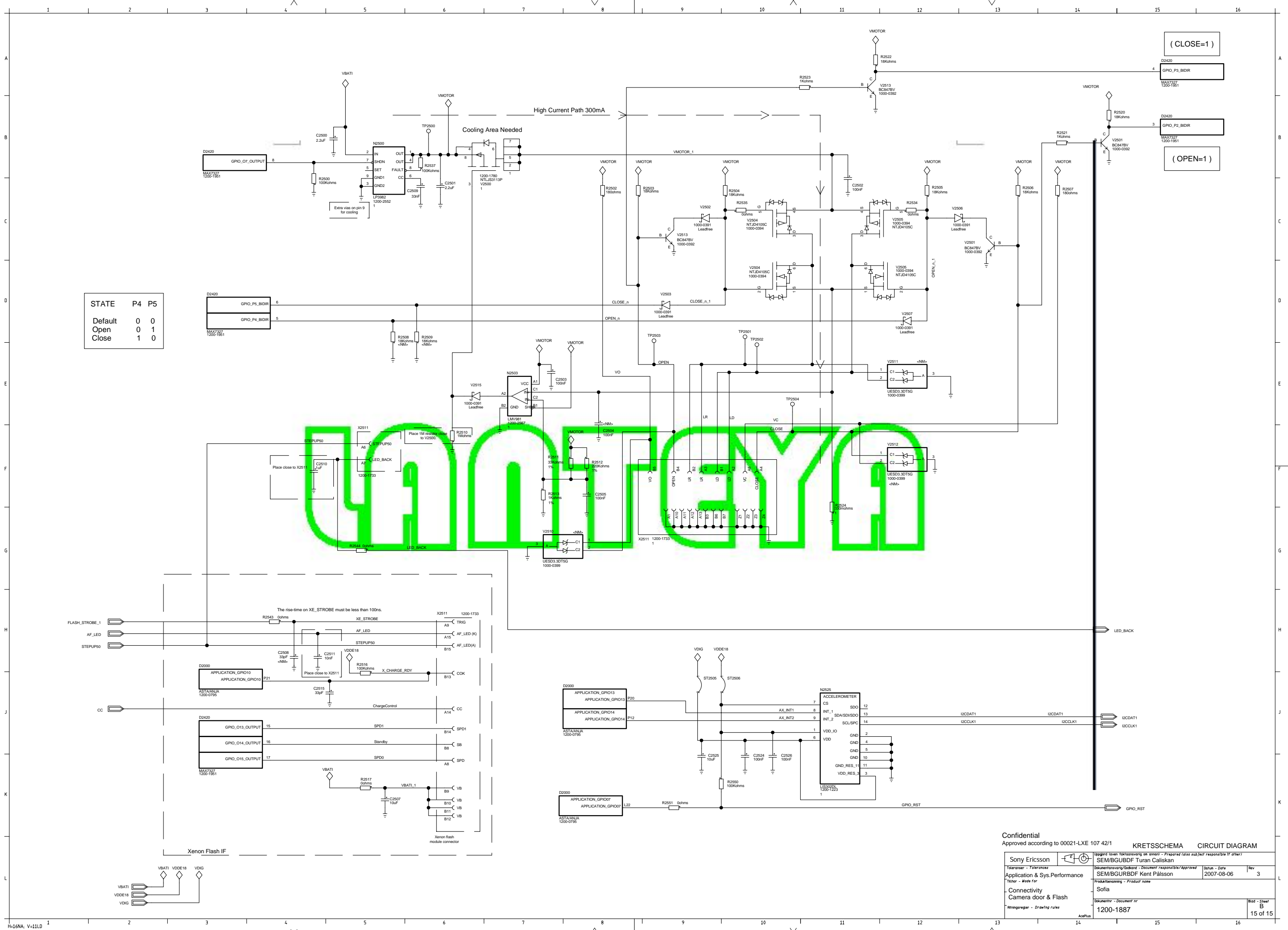

STATE	P4	P5
Default	0	0
Open	0	1
Close	1	0

(CLOSE=1)

(OPEN=1)

Xenon Flash IF

Confidential
Approved according to 00021-LXE 107 42/1

KRETSSCHEMA CIRCUIT DIAGRAM

Sony Ericsson	SEM/BGUBDF Turan Caliskan	Uppgift läven faktansvarig an annan - Prepared (also subject responsible if other)
Application & Sys. Performance	SEM/BGURBDF Kent Pålsson	Datum - Date 2007-08-06
Talior - Made for	Sofia	Rev 3
Connectivity	Dokumentnr - Document nr 1200-1887	Bild - Sheet B
Camera door & Flash	Ritningsregler - Drawing rules	15 of 15

LZF 030 101/F RB1